



Spacial Thalassa ClimaSys

US Catalog 2022

Universal Enclosures

More than 60 years protecting your equipment



se.com/enclosures

Life Is On

Schneider
Electric

Life Is On

Contents

Overview	4
Services / Software / General Information	8
Selection Guide (Reference overview)	10
Spacial	
1 Steel Industrial Boxes	34
2 Steel wall-mounted enclosures	46
3 Steel floor-standing enclosures	94
4 Stainless-steel Industrial Boxes	134
5 Stainless-steel wall-mounted enclosures	146
6 Stainless-steel floor-standing enclosures	158
Thalassa	
7 Insulated boxes	168
8 Insulated wall-mounted enclosures	196
9 Insulated floor-standing enclosures	212
Accessories	
10 Accessories	238
Applicative solutions	
11 Applicative solutions	322
ClimaSys	
12 Thermal management system	438
Technical guides	
13 Technical guides and spare parts	504
Index	
14 Index of references	538



Green Premium™

More than 75% of our product sales offer superior transparency on the material content, regulatory information and environmental impact of our products:

- RoHS compliance
- REACh substance information
- Industry leading # of PEP's*
- Circularity instructions

*PEP: Product Environmental Profile (i.e. Environmental Product Declaration)

Discover what we mean by green!
Check your products!



Scan or click

The Green Premium program stands for our commitment to deliver customer-valued sustainable performance. It has been upgraded with recognized environmental claims and extended to cover all offers including products, services and solutions.

CO₂ and P&L impact through... resource performance

Green Premium brings improved resource efficiency throughout an asset's lifecycle. This includes efficient use of energy and natural resources, along with the minimization of CO₂ emissions.

Cost of ownership optimization through... circular performance

We're helping our customers optimize the total cost of ownership of their assets. To do this, we provide IoT-enabled solutions, as well as upgrade, repair, retrofit, and remanufacture services.

Peace of mind through... health performance

Green Premium products are RoHS and REACh compliant. We're going beyond regulatory compliance with step-by-step substitution of certain materials and substances from our products.

Improved sales through... differentiation

Green Premium delivers strong value propositions through third-party labels and services. By collaborating with third-party organizations we can support our customers in meeting their sustainability goals such as green-building certifications.

How to define an enclosure solution?

Invariables

Switchgear and Controlgear are the cornerstone of any electrical system - in industry, infrastructure, building, energy, transport or any other segment. The correct enclosure and thermal management selection is crucial to guarantee the targeted performance. Safeguards of equipment installed inside ensure service continuity.

Correct selection of enclosure and thermal solution

Many influences must be considered when defining an enclosure system.

Three groups may be distinguished:

- Protection (equipment and people)
- Thermal management
- Solution profitability

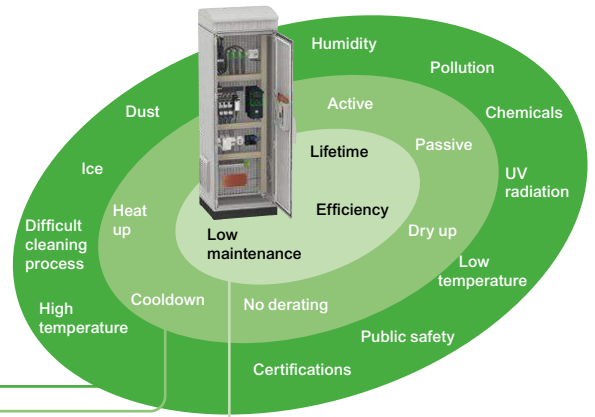

Ambient conditions and enclosure

The table below is only indicative and not binding. It shows, in a general concept, the optimized performance of the ranges of Universal Enclosures according to the ambient conditions, taking into account technical and commercial criteria:

- Highly recommended
- Recommended
- Not suitable

Ambient condition	Enclosure material						
	Steel	Steel Heavy-Duty	Stainless-steel 304L	Stainless-steel 316L	Stainless-steel 316L Paint	Polyester	Polyester Heavy-Duty
Indoor clean environment ⁽¹⁾	■■■	■	■	■	■	■	■
Difficult cleaning process ⁽²⁾	-	-	■■■	■■■	-	-	-
Outdoor (no public access)	-	■■■	■	■	■	■■■	■■■
Outdoor (public access)	-	■	■	■	■	■	■■■
Harsh chemicals	-	■	■■■	■■■	■■■	■■■	■■■
Solar radiation	-	■■■	-	■ ⁽⁴⁾	■ ⁽⁴⁾	■■■	■■■
Sand storms	-	-	■■■	■■■	-	■	■
Temperature > 40°C (104°F) ⁽³⁾	■■■	■■■	■■■	■■■	■■■	■■■	■■■
Temperature < 5°C (41°F) ⁽³⁾	■■■	■■■	■■■	■■■	■■■	■■■	■■■
Salty environment	-	-	-	■■■	■■■	■■■	■■■
Sea water splashes	-	-	-	■■■	■■■	■■■	■■■
Humidity > 70% ⁽³⁾	-	■■■	■■■	■■■	■■■	■■■	■■■
Impact	■■■	■■■	■■■	■■■	■■■	■■■	■■■
Vandalism	-	■■■	■	■	■	■	■■■
Burglary	-	■■■	■	■	■	■	■■■
Strong pollution	■	■■■	■■■	■■■	■■■	■■■	■■■
Vibration (marine application)	■■■	-	■■■	■■■	■■■	■■■	-
Seismic activity	■■■	-	-	-	-	-	-
Electro-magnetic interference	■■■	-	-	-	-	-	-

⁽¹⁾ Not considering F&B process

⁽²⁾ e.g. F&B process

⁽³⁾ Always using ClimaSys solutions

⁽⁴⁾ Marine solar plants

Thermal management

The thermal management system must ensure the temperature and humidity controlled inside the enclosure.

The correct solution must be based on a robust process starting with the diagnosis of the ambient conditions, going to the parameters calculations and defining the best architecture (enclosures + equipment installed + thermal solution).

ClimaSys is the definitive solution based on ClimaSys DT/EffiClima/ProClima.

Universal Enclosures

Our ranges, solutions for each application

Spacial



Metal enclosures and boxes

From our small boxes to large suitable floor-standing enclosures, the range of Spacial products offers the perfect fit for your applications. Our extensive range of easy-to-use accessories helps you save time during your projects. Select between steel or stainless-steel to better suit the installation environment. Our stainless-steel products represent the optimal solution where cleanliness is required, or for highly corrosive environments.

Thalassa



Insulated enclosures

Operating the equipment under adverse ambient conditions may expose your installation to chemical or aggressive substances. Our Thalassa range, from boxes to floor-standing enclosures, has been developed to efficiently protect your equipment. The products are made of fiberglass-reinforced polyester to resist harsh conditions and outdoor use. The Thalassa industrial boxes in ABS or polycarbonate are strong, easy to install and designed to be used in highly demanding environments.

ClimaSys



Thermal management

Maintaining the right temperature inside your enclosure is vital for maximising the lifetime of your installed devices. Our ClimaSys range offers you the right solution: airing, cooling or heating, including control units for temperature, humidity and many other parameters.

Industry and Infrastructure Offer

A material for every environment

Steel



Indoor non-clean industrial environment

The industrial environment in mechanical plants is especially demanding as regards the protection of electric and electronic components against dust, splashing with oil and impacts. Such ambient conditions require a range that is suited to the application and easy to implement.

- Standard range for industrial applications.
- E.M.C. just available for WM (S3HF)
- Range of ATEX enclosures, for potentially explosive atmospheres.

Solution:

The Spacial range in steel
(wall-mounted, monobloc and suitable floor-standing enclosures).

304L - 316L stainless-steel



Demanding industrial environment

Food and beverage, pharmaceutical, petrochemical and infrastructure industries are particularly demanding in terms of hygiene and resistance to corrosion. Our products are available with two grades of stainless-steel:

- 304L stainless-steel:
Corrosion resistance and cleanability
(often used in food production).
- 316L stainless-steel: Also known as "marine stainless-steel".
Very high resistance to corrosion (saline or chlorinated environment).

Solution:

The Spacial range in stainless-steel
(wall-mounted, monobloc and suitable floor-standing enclosures).

Insulated polyester and plastic materials (ABS, polycarbonate)

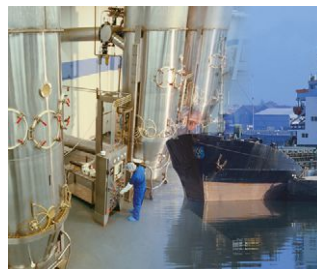

Infrastructures and industrial environments

Outdoor infrastructures and electrical installations are exposed to direct sunlight, rain, saline mist, extreme temperatures, oil splashes, chemical and corrosive agents.

- Standard range for industry and infrastructures.

Solution:

The Thalassa range
(boxes, wall-mounted and floor-standing enclosures).

Heavy-Duty materials



Severe outdoor environments, generally requested by OEMs, the telecommunication, water treatment and transportation industry

Heavy-Duty polyester units are suitable for outdoor public areas thanks to its multiple benefits:

- Resistant against pressure and shock (IEC 61439-5: 2010),
 - Door with ribbed surface against posting,
 - Insulated (prepared for Class II according to IEC 61439-1: 2011).
- Heavy-Duty steel enclosures are designed for outdoor private areas:
- Resistant against aggressive environments (anti-corrosion certification class C4H, ISO 12944:2018).

Solution:

The Thalassa PHD and Spacial S3HD and SFHD ranges
(wall-mounted and floor-standing).



Selection Tools

www.se.com

Our web site allows you to access all Schneider Electric products with just two clicks with direct links to:

- A complete library of technical documents, catalogues, FAQs brochures, etc.
- Certificates.
- 2D and 3D drawings.
- Selection Guides from the e-catalogue.
- Product discovery sites.

You may also find illustrated overviews, news to which you can subscribe, a list of contacts in your country and other useful information.

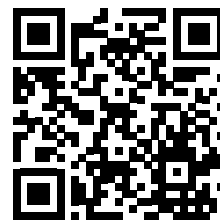

Scan or click

Digital Offer

ProClima

Find the best thermal solution for your enclosure

Select and calculate your thermal management requirements according to the environment and the electrical/electronic devices installed in the enclosure.



Digital Rules

Find the accessories that suit your enclosure

The digital rules allow you to select the best components from the current product range. There will be no risk of mistake since product and accessory selection take place automatically, saving you time and money.



Have a smartphone or a tablet? Scan this:

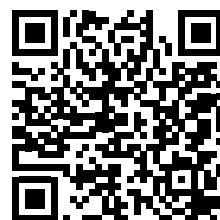

Scan or click

Metal junction boxes SDB IP55, low cover models

External dimensions mm (in.)			Models without knock-outs	Models with knock-outs, n° of drill holes, knock-outs and group		Internal dimensions mm (in.)			Plain mounting plate	Weight	
Height (A)	Width (B)	Depth (C)	References	References	Height (A)	Width (B)	D	E	F	References	kg (lbs.)
85 (3.35)	85 (3.35)	49 (1.93)	NSYDBN88	NSYDB88M	1 n° 1	1 n° 1	58 (2.28)	58 (2.28)	-		0.18 (0.40)
105 (4.13)	105 (4.13)	49 (1.93)	NSYDBN1010	NSYDB1010M	2 n° 1	1 n° 1	76 (2.99)	76 (2.99)	-		0.25 (0.55)
155 (6.10)	105 (4.13)	61 (2.40)	NSYDBN1510	NSYDB1510M	3 n° 1	1 n° 1	124 (4.88)	74 (2.91)	56 (2.20)	NSYPMD1510	0.38 (0.84)
206 (8.11)	156 (6.14)	83 (3.27)	NSYDBN2015	NSYDB2015M	3 n° 2	2 n° 2	172 (6.77)	122 (4.80)	78 (3.07)	NSYPMD2015	1.00 (2.20)
256 (10.08)	206 (8.11)	93 (3.66)	NSYDBN2520	-	-	-	220 (8.66)	170 (6.69)	88 (3.46)	NSYPMD2520	1.5 (3.31)
307 (12.09)	257 (10.12)	116 (4.57)	NSYDBN3025	-	-	-	268 (10.55)	218 (8.58)	110 (4.33)	NSYPMD3025	3.3 (7.28)

Metal modular boxes

External dimensions mm (in.)			SBM
Height	Width	Depth	References
150 (5.91)	150 (5.91)	80 (3.15)	NSYSBM15158
150 (5.91)	150 (5.91)	120 (4.72)	NSYSBM151512
150 (5.91)	200 (7.87)	80 (3.15)	NSYSBM15208
150 (5.91)	200 (7.87)	120 (4.72)	NSYSBM152012
150 (5.91)	300 (11.81)	80 (3.15)	NSYSBM15308
150 (5.91)	300 (11.81)	120 (4.72)	NSYSBM153012
150 (5.91)	400 (15.75)	80 (3.15)	NSYSBM15408
150 (5.91)	400 (15.75)	120 (4.72)	NSYSBM154012
200 (7.87)	200 (7.87)	80 (3.15)	NSYSBM20208
200 (7.87)	200 (7.87)	120 (4.72)	NSYSBM202012
200 (7.87)	300 (11.81)	80 (3.15)	NSYSBM20308
200 (7.87)	300 (11.81)	120 (4.72)	NSYSBM203012
200 (7.87)	400 (15.75)	80 (3.15)	NSYSBM20408
200 (7.87)	400 (15.75)	120 (4.72)	NSYSBM204012
200 (7.87)	500 (19.68)	80 (3.15)	NSYSBM20508
200 (7.87)	500 (19.68)	120 (4.72)	NSYSBM205012
200 (7.87)	600 (23.62)	80 (3.15)	NSYSBM20608
200 (7.87)	600 (23.62)	120 (4.72)	NSYSBM206012
200 (7.87)	800 (31.50)	120 (4.72)	NSYSBM208012
300 (11.81)	300 (11.81)	120 (4.72)	NSYSBM303012
300 (11.81)	400 (15.75)	120 (4.72)	NSYSBM304012
300 (11.81)	500 (19.68)	120 (4.72)	NSYSBM305012
300 (11.81)	600 (23.62)	120 (4.72)	NSYSBM306012
300 (11.81)	800 (31.50)	120 (4.72)	NSYSBM308012
400 (15.75)	400 (15.75)	120 (4.72)	NSYSBM404012
400 (15.75)	500 (19.68)	120 (4.72)	NSYSBM405012
400 (15.75)	600 (23.62)	120 (4.72)	NSYSBM406012
400 (15.75)	800 (31.50)	120 (4.72)	NSYSBM408012





Accessories and mounting plates for metal modular boxes:

For further information about accessories and mounting plates see [page 42](#)

Spacial SBX Flat boxes

Dimensions mm (in.)			SBX
Height	Width	Depth	References
150 (5.91)	150 (5.91)	80 (3.15)	NSYSBX15158
150 (5.91)	300 (11.81)	80 (3.15)	NSYSBX15308
200 (7.87)	200 (7.87)	80 (3.15)	NSYSBX20208
200 (7.87)	300 (11.81)	80 (3.15)	NSYSBX20308
200 (7.87)	400 (15.75)	120 (4.72)	NSYSBX204012
300 (11.81)	300 (11.81)	120 (4.72)	NSYSBX303012





Universal boxes with IP66

											Universal boxes with IP66			
											ABS IP66 IK07		PC-UL IP66 IK08	
														
											Opaque cover	Made of polycarbonate	Opaque cover	Transparent cover
Overall external dimensions			Overall internal dimensions			Body	Cover	Minor pack.	Cover screw	References	References	References	References	
Height mm (in.)	Width mm (in.)	Depth mm (in.)	Height mm (in.)	Width mm (in.)	Depth mm (in.)	mm (in.)	mm (in.)							
74 (2.91)	74 (2.91)	54 (2.13)	65 (2.56)	65 (2.56)	47 (1.85)	37 (1.46)	10 (0.39)	5	Metal	NSYTBS775	-	NSYTBP775	-	
89 (3.50)	89 (3.50)	54 (2.13)	80 (3.15)	80 (3.15)	47 (1.85)	37 (1.46)	10 (0.39)	5	Metal	NSYTBS885	-	NSYTBP885	-	
116 (4.57)	74 (2.91)	62 (2.44)	105 (4.13)	65 (2.56)	55 (2.16)	45 (1.77)	10 (0.39)	5	Metal	NSYTBS1176	-	NSYTBP1176	-	
116 (4.57)	74 (2.91)	94 (3.70)	105 (4.13)	65 (2.56)	85 (3.35)	45 (1.77)	40 (1.58)	3	Metal	NSYTBS1179H	-	-	-	
116 (4.57)	116 (4.57)	62 (2.44)	105 (4.13)	105 (4.13)	55 (2.16)	45 (1.77)	10 (0.39)	5	Plastic	NSYTBS11116	-	NSYTBP11116	-	
138 (5.43)	116 (4.57)	133 (5.24)	105 (4.13)	105 (4.13)	125 (4.92)	45 (1.77)	80 (3.15)	2	Plastic	NSYTBS111113H	-	-	-	
164 (6.46)	93 (3.66)	72 (2.84)	125 (4.92)	80 (3.15)	65 (2.56)	45 (1.77)	20 (0.79)	2	Plastic	NSYTBS1397	NSYTBS1397T	NSYTBP1397	NSYTBP1397T	
192 (7.56)	121 (4.76)	87 (3.42)	150 (5.91)	105 (4.13)	80 (3.15)	60 (2.36)	20 (0.79)	2	Plastic	NSYTBS16128	NSYTBS16128T	NSYTBP16128	NSYTBP16128T	
192 (7.56)	121 (4.76)	87 (3.42)	175 (6.89)	105 (4.13)	80 (3.15)	60 (2.36)	20 (0.79)	2	Plastic	NSYTBS19128	NSYTBS19128T	NSYTBP19128	NSYTBP19128T	
192 (7.56)	121 (4.76)	105 (4.13)	175 (6.89)	105 (4.13)	100 (3.94)	60 (2.36)	40 (1.58)	2	Plastic	NSYTBS191210H	NSYTBS191210HT	NSYTBP191210H	NSYTBP191210HT	
192 (7.56)	164 (6.46)	87 (3.42)	175 (6.89)	150 (5.91)	80 (3.15)	60 (2.36)	20 (0.79)	1	Plastic	NSYTBS19168	NSYTBS19168T	NSYTBP19168	NSYTBP19168T	
192 (7.56)	164 (6.46)	105 (4.13)	175 (6.89)	150 (5.91)	100 (3.94)	60 (2.36)	40 (1.58)	1	Plastic	NSYTBS191610H	NSYTBS191610HT	NSYTBP191610H	NSYTBP191610HT	
241 (9.49)	194 (7.64)	87 (3.42)	225 (8.86)	175 (6.89)	80 (3.15)	60 (2.36)	20 (0.79)	1	Plastic	NSYTBS24198	NSYTBS24198T	NSYTBP24198	NSYTBP24198T	
241 (9.49)	194 (7.64)	107 (4.21)	225 (8.86)	175 (6.89)	100 (3.94)	80 (3.15)	20 (0.79)	1	Plastic	NSYTBS241910	NSYTBS241910T	NSYTBP241910	NSYTBP241910T	
241 (9.49)	194 (7.64)	107 (4.21)	225 (8.86)	175 (6.89)	100 (3.94)	60 (2.36)	40 (1.58)	1	Plastic	NSYTBS241910H	NSYTBS241910HT	NSYTBP241910H	NSYTBP241910HT	
241 (9.49)	194 (7.64)	127 (5.00)	225 (8.86)	175 (6.89)	120 (4.72)	80 (3.15)	40 (1.58)	1	Plastic	NSYTBS241912H	NSYTBS241912HT	NSYTBP241912H	NSYTBP241912HT	
291 (11.46)	241 (9.49)	88 (3.46)	275 (10.83)	225 (8.86)	80 (3.15)	60 (2.36)	20 (0.79)	1	Plastic	NSYTBS29248	NSYTBS29248T	NSYTBP29248	NSYTBP29248T	
291 (11.46)	241 (9.49)	128 (5.04)	275 (10.83)	225 (8.86)	120 (4.72)	100 (3.94)	20 (0.79)	1	Plastic	NSYTBS292412	NSYTBS292412T	NSYTBP292412	NSYTBP292412T	
291 (11.46)	241 (9.49)	128 (5.04)	275 (10.83)	225 (8.86)	120 (4.72)	60 (2.36)	60 (2.36)	1	Plastic	NSYTBS292412H	NSYTBS292412HT	NSYTBP292412H	NSYTBP292412HT	
291 (11.46)	241 (9.49)	168 (6.61)	275 (10.83)	225 (8.86)	160 (6.30)	100 (3.94)	60 (2.36)	1	Plastic	NSYTBS292416H	NSYTBS292416HT	NSYTBP292416H	NSYTBP292416HT	
341 (13.42)	291 (11.46)	128 (5.04)	325 (12.80)	275 (10.83)	120 (4.72)	100 (3.94)	20 (0.79)	1	Plastic	NSYTBS342912	NSYTBS342912T	NSYTBP342912	NSYTBP342912T	
341 (13.42)	291 (11.46)	168 (6.61)	325 (12.80)	275 (10.83)	160 (6.30)	100 (3.94)	60 (2.36)	1	Plastic	NSYTBS342916H	NSYTBS342916HT	NSYTBP342916H	NSYTBP342916HT	

Accessories and mounting plates for universal boxes with IP66:

For further information about accessories and mounting plates see [page 174](#)



Universal boxes with IP66





				Complete box			
							
Dimensions				Transparent cover	Opaque cover		Polyester cover
Height mm (in.)	Width mm (in.)	Depth mm (in.)	References	References	References	References	
180 (7.09)	270 (10.63)	180 (7.09)	NSYPLS1827G	NSYPLSC1827G		NSYPLSP1827G	
270 (10.63)	270 (10.63)	180 (7.09)	NSYPLS2727G	NSYPLSC2727G		NSYPLSP2727G	
270 (10.63)	270 (10.63)	230 (9.06)	NSYPLS2727AG	NSYPLSC2727AG		-	
270 (10.63)	360 (14.17)	180 (7.09)	NSYPLS2736G	NSYPLSC2736G		NSYPLSP2736G	
270 (10.63)	360 (14.17)	230 (9.06)	NSYPLS2736AG	NSYPLSC2736AG		-	
270 (10.63)	540 (21.26)	180 (7.09)	NSYPLS2754G	NSYPLSC2754G		NSYPLSP2754G	
270 (10.63)	540 (21.26)	230 (9.06)	NSYPLS2754AG	NSYPLSC2754AG		-	
360 (14.17)	360 (14.17)	180 (7.09)	NSYPLS3636G	NSYPLSC3636G		NSYPLSP3636G	
360 (14.17)	540 (21.26)	180 (7.09)	NSYPLS3654G	NSYPLSC3654G		NSYPLSP3654G	
360 (14.17)	540 (21.26)	230 (9.06)	NSYPLS3654AG	NSYPLSC3654AG		-	
360 (14.17)	720 (28.35)	230 (9.06)	NSYPLS3672AG	NSYPLSC3672AG		-	
540 (21.26)	540 (21.26)	180 (7.09)	NSYPLS5454G	NSYPLSC5454G		NSYPLSP5454G	
540 (21.26)	540 (21.26)	230 (9.06)	NSYPLS5454AG	NSYPLSC5454AG		-	
540 (21.26)	720 (28.35)	230 (9.06)	NSYPLS5472AG	NSYPLSC5472AG		-	

Accessories and mounting plates for modular boxes:





For further information about accessories and mounting plates see [page 186](#)

Technical changes reserved. Information provided without guarantee. Images are for illustrative purposes only.

					Spacial S3DC painted steel enclosures	Spacial S3X Stainless-steel 304L	Spacial S3XH Stainless-steel 316L
Dimensions (mm and inches)							
H mm (in.)	W mm (in.)	D mm (in.)	Doors	IP	Plain door without mounting plate	Plain door without mounting plate	Plain door without mounting plate
300 (11.81)	200 (7.87)	150 (5.91)	1	66	NSYS3DC3215	NSYS3X3215	NSYS3X3215H
300 (11.81)	300 (11.81)	150 (5.91)	1	66	NSYS3DC3315	NSYS3X3315	NSYS3X3315H
300 (11.81)	300 (11.81)	200 (7.87)	1	66	NSYS3DC3320	-	-
400 (15.75)	300 (11.81)	150 (5.91)	1	66	NSYS3DC4315	NSYS3X4315	NSYS3X4315H
400 (15.75)	300 (11.81)	200 (7.87)	1	66	NSYS3DC4320	NSYS3X4320	NSYS3X4320H
400 (15.75)	400 (15.75)	200 (7.87)	1	66	NSYS3DC4420	NSYS3X4420	NSYS3X4420H
500 (19.69)	400 (15.75)	200 (7.87)	1	66	NSYS3DC5420	NSYS3X5420	NSYS3X5420H
500 (19.69)	400 (15.75)	250 (9.84)	1	66	NSYS3DC5425	-	-
500 (19.69)	500 (19.69)	200 (7.87)	1	66	NSYS3DC5520	-	-
500 (19.69)	500 (19.69)	250 (9.84)	1	66	NSYS3DC5525	-	-
600 (23.62)	400 (15.75)	200 (7.87)	1	66	NSYS3DC6420	NSYS3X6420	NSYS3X6420H
600 (23.62)	400 (15.75)	250 (9.84)	1	66	NSYS3DC6425	-	-
600 (23.62)	600 (23.62)	200 (7.87)	1	66	NSYS3DC6620	-	-
600 (23.62)	600 (23.62)	250 (9.84)	1	66	NSYS3DC6625	NSYS3X6625	NSYS3X6625H
600 (23.62)	600 (23.62)	300 (11.81)	1	66	NSYS3DC6630	-	-
700 (27.56)	500 (19.69)	250 (9.84)	1	66	NSYS3DC7525	NSYS3X7525	NSYS3X7525H
800 (31.50)	600 (23.62)	200 (7.87)	1	66	NSYS3DC8620	-	-
800 (31.50)	600 (23.62)	250 (9.84)	1	66	NSYS3DC8625	NSYS3X8625	NSYS3X8625H
800 (31.50)	600 (23.62)	300 (11.81)	1	66	NSYS3DC8630	-	-
800 (31.50)	600 (23.62)	400 (15.75)	1	66	NSYS3DC8640	-	-
800 (31.50)	800 (31.50)	250 (9.84)	1	66	NSYS3DC8825	-	-
800 (31.50)	800 (31.50)	300 (11.81)	1	66	NSYS3DC8830	NSYS3X8830	NSYS3X8830H
1000 (39.37)	600 (23.62)	250 (9.84)	1	66	NSYS3D10625	-	-
1000 (39.37)	800 (31.50)	250 (9.84)	1	66	NSYS3DC10825	-	-
1000 (39.37)	800 (31.50)	300 (11.81)	1	66	NSYS3DC10830	NSYS3X10830	NSYS3X10830H
1000 (39.37)	800 (31.50)	400 (15.75)	1	66	NSYS3DC10840	-	-
1000 (39.37)	1000 (39.37)	300 (11.81)	1	66	NSYS3DC101030	-	-
1200 (47.24)	800 (31.50)	300 (11.81)	1	66	NSYS3DC12830	NSYS3X12830	NSYS3X12830H
1200 (47.24)	800 (31.50)	400 (15.75)	1	66	NSYS3DC12840	-	-
1200 (47.24)	1000 (39.37)	300 (11.81)	1	66	NSYS3DC121030	-	-





Wall-mounted bracket (x4)	References	Mounting	References
 Steel	NSYAEFPFSC	M6 nut for PLM direct mounting	NSYTCSPML
 Stainless-steel	NSYPFCX	Self-tapping screw for microperforated mounting plate	NSYS13M5HS
 Polyester	NSYPFPLM	Hexagonal screw M6 3 12 for alum. upright	NSYS12M6H
		Hexagonal screw M6 3 16 for alum. upright	NSYS16M6H
		Hexagonal screw M6 3 18 for alum. upright	NSYS18M6H
		M6 nut for alum. upright	NSYNM6
Lighting	References		
 Neon light, magnetic or mechanical mounting	NSYLAM75		
 Door contact S3DC/S3X	NSYINLCRN		





Technical changes reserved. Information provided without guarantee. Images are for illustrative purposes only.

Thalassa PLM Polyester						
						
Plain door without mounting plate	Plain mounting plate painted white	Plain mounting plate galvanized	Microperforated mounting plate	Perforated (Telequick™) (1)	Aluminum upright (2)	
NSYPLM32	NSYMM32WH	NSYMM32	NSYMF32	NSYMR32	NSYMDVR3	
-	NSYMM33WH	NSYMM33	NSYMF33	NSYMR33	NSYMDVR3	
-	NSYMM33WH	NSYMM33	NSYMF33	NSYMR33	NSYMDVR3	
-	NSYMM43WH	NSYMM43	NSYMF43	NSYMR43	NSYMDVR4	
NSYPLM43	NSYMM43WH	NSYMM43	NSYMF43	NSYMR43	NSYMDVR4	
-	NSYMM44WH	NSYMM44	NSYMF44	NSYMR44	NSYMDVR4	
-	NSYMM54WH	NSYMM54	NSYMF54	NSYMR54	NSYMDVR5	
-	NSYMM54WH	NSYMM54	NSYMF54	NSYMR54	NSYMDVR5	
-	NSYMM55WH	NSYMM55	NSYMF55	NSYMR55	NSYMDVR5	
-	NSYMM55WH	NSYMM55	NSYMF55	NSYMR55	NSYMDVR5	
-	NSYMM64WH	NSYMM64	NSYMF64	NSYMR64	NSYMDVR6	
NSYPLM64	NSYMM64WH	NSYMM64	NSYMF64	NSYMR64	NSYMDVR6	
-	NSYMM66WH	NSYMM66	NSYMF66	NSYMR66	NSYMDVR6	
-	NSYMM66WH	NSYMM66	NSYMF66	NSYMR66	NSYMDVR6	
-	NSYMM66WH	NSYMM66	NSYMF66	NSYMR66	NSYMDVR6	
-	NSYMM66WH	NSYMM66	NSYMF66	NSYMR66	NSYMDVR6	
-	NSYMM75WH	NSYMM75	NSYMF75	NSYMR75	NSYMDVR7	
-	NSYMM86WH	NSYMM86	NSYMF86	NSYMR86	NSYMDVR8	
-	NSYMM86WH	NSYMM86	NSYMF86	NSYMR86	NSYMDVR8	
NSYPLM86	NSYMM86WH	NSYMM86	NSYMF86	NSYMR86	NSYMDVR8	
-	NSYMM86WH	NSYMM86	NSYMF86	NSYMR86	NSYMDVR8	
-	NSYMM88WH	NSYMM88	NSYMF88	NSYMR88	NSYMDVR8	
-	NSYMM88WH	NSYMM88	NSYMF88	NSYMR88	NSYMDVR8	
-	NSYMM106WH	NSYMM106	NSYMF106	NSYMR106	NSYMDVR10	
-	NSYMM108WH	NSYMM108	NSYMF108	NSYMR108	NSYMDVR10	
NSYPLM108	NSYMM108WH	NSYMM108	NSYMF108	NSYMR108	NSYMDVR10	
-	NSYMM108WH	NSYMM108	NSYMF108	NSYMR108	NSYMDVR10	
-	NSYMM1010WH	NSYMM1010	NSYMF1010	NSYMR1010	NSYMDVR10	
-	NSYMM128WH	NSYMM128	NSYMF128	NSYMR128	NSYMDVR12	
-	NSYMM128WH	NSYMM128	NSYMF128	NSYMR128	NSYMDVR12	
-	NSYMM1210WH	NSYMM1210	NSYMF1210	NSYMR1210	NSYMDVR12	

(1) NSYEMR is mandatory for Spacial S3DC enclosure width > 1000 (39.37) mm (in.).

(2) NSYAMCSF is mandatory for S3DC and S3X enclosures

Door accessories	References
 Door cable trunking support for Ø 22 mm / 0.86 in (310)	NSYSPCP
 Plastic document pocket A4, d = 20 (0.79) mm (in.)	NSYDPA4
 Plastic document pocket A4, d = 40 (1.58) mm (in.)	NSYDPA44
 Plastic window 248 (9.76) X 235 (9.25) X 13 (0.51) mm (in.)	NSYVA2736M
 Plastic window 78 (3.07) X 95 (3.74) X 15 (0.59) mm (in.)	NSYVA274M





Grounding	References
 Grounding lead 160, sec. 6²	NSYEL166D8
 Grounding lead L350, sec. 25²	NSYEL3525D8
 Grounding strip connection points 87	NSYECB1M153
 2 grounding collector supports	NSYEDCOS
 2 grounding collector rail supports	NSYEDCOC



Locking system	References
 Screwdriver insert for Thalassa PLM	NSYAE LSD

Technical changes reserved. Information provided without guarantee. Images are for illustrative purposes only.



Dimensions (mm and inches)			Doors	IP	Weight of empty enclosures: kg (lbs)	Plain front door		
H mm (in.)	W mm (in.)	D mm (in.)				Without mounting plate	Plain mounting plate painted white	Plain mounting plate galvanized
300 (11.81)	200 (7.87)	150 (5.91)	1	66	2.82 (6.2)	NSYS3DC3215	NSYMM32WH	NSYMM32
300 (11.81)	300 (11.81)	150 (5.91)	1	66	3.18 (7.0)	NSYS3DC3315	NSYMM33WH	NSYMM33
300 (11.81)	300 (11.81)	200 (7.87)	1	66	4.07 (9.0)	NSYS3DC3320	NSYMM33WH	NSYMM33
400 (15.75)	300 (11.81)	150 (5.91)	1	66	4.66 (10.3)	NSYS3DC4315	NSYMM43WH	NSYMM43
400 (15.75)	300 (11.81)	200 (7.87)	1	66	4.57 (10.1)	NSYS3DC4320	NSYMM43WH	NSYMM43
400 (15.75)	400 (15.75)	200 (7.87)	1	66	5.92 (13.1)	NSYS3DC4420	NSYMM44WH	NSYMM44
500 (19.69)	400 (15.75)	200 (7.87)	1	66	8.72 (19.2)	NSYS3DC5420	NSYMM54WH	NSYMM54
500 (19.69)	400 (15.75)	250 (9.84)	1	66	9.62 (21.2)	NSYS3DC5425	NSYMM54WH	NSYMM54
500 (19.69)	500 (19.69)	200 (7.87)	1	66	10.41 (23.0)	NSYS3DC5520	NSYMM55WH	NSYMM55
500 (19.69)	500 (19.69)	250 (9.84)	1	66	11.29 (24.9)	NSYS3DC5525	NSYMM55WH	NSYMM55
600 (23.62)	400 (15.75)	200 (7.87)	1	66	10.11 (22.3)	NSYS3DC6420	NSYMM64WH	NSYMM64
600 (23.62)	400 (15.75)	250 (9.84)	1	66	11.42 (25.2)	NSYS3DC6425	NSYMM64WH	NSYMM64
600 (23.62)	600 (23.62)	200 (7.87)	1	66	13.11 (28.9)	NSYS3DC6620	NSYMM66WH	NSYMM66
600 (23.62)	600 (23.62)	250 (9.84)	1	66	14.11 (31.1)	NSYS3DC6625	NSYMM66WH	NSYMM66
600 (23.62)	600 (23.62)	300 (11.81)	1	66	15.59 (34.4)	NSYS3DC6630	NSYMM66WH	NSYMM66
700 (27.56)	500 (19.69)	250 (9.84)	1	66	14.23 (31.4)	NSYS3DC7525	NSYMM75WH	NSYMM75
800 (31.50)	600 (23.62)	200 (7.87)	1	66	20.11 (44.3)	NSYS3DC8620	NSYMM86WH	NSYMM86
800 (31.50)	600 (23.62)	250 (9.84)	1	66	22.11 (48.7)	NSYS3DC8625	NSYMM86WH	NSYMM86
800 (31.50)	600 (23.62)	300 (11.81)	1	66	23.59 (52.0)	NSYS3DC8630	NSYMM86WH	NSYMM86
800 (31.50)	600 (23.62)	400 (15.75)	1	66	27.59 (60.8)	NSYS3DC8640	NSYMM86WH	NSYMM86
800 (31.50)	800 (31.50)	250 (9.84)	1	66	29.42 (64.9)	NSYS3DC8825	NSYMM88WH	NSYMM88
800 (31.50)	800 (31.50)	300 (11.81)	1	66	31.42 (69.3)	NSYS3DC8830	NSYMM88WH	NSYMM88
1000 (39.37)	600 (23.62)	250 (9.84)	1	66	27.11 (59.8)	NSYS3DC10625	NSYMM106WH	NSYMM106
1000 (39.37)	800 (31.50)	250 (9.84)	1	66	33.84 (74.6)	NSYS3DC10825	NSYMM108WH	NSYMM108
1000 (39.37)	800 (31.50)	300 (11.81)	1	66	36.84 (81.2)	NSYS3DC10830	NSYMM108WH	NSYMM108
1000 (39.37)	800 (31.50)	400 (15.75)	1	66	40.84 (90.0)	NSYS3DC10840	NSYMM108WH	NSYMM108
1000 (39.37)	1000 (39.37)	300 (11.81)	1	66	44.46 (98.0)	NSYS3DC101030	NSYMM1010WH	NSYMM1010
1200 (47.24)	800 (31.50)	300 (11.81)	1	66	43.84 (96.7)	NSYS3DC12830	NSYMM128WH	NSYMM128
1200 (47.24)	800 (31.50)	400 (15.75)	1	66	47.84 (105.5)	NSYS3DC12840	NSYMM128WH	NSYMM128
1200 (47.24)	1000 (39.37)	300 (11.81)	1	66	51.46 (113.4)	NSYS3DC121030	NSYMM1210WH	NSYMM1210

Installation accessories	References
 Set of 4 steel mounting lugs	NSYAEFFPFC
 Set of 4 stainless-steel mounting lugs	NSYAEFFFXSC
 Kit for heavy loads	NSYAEFAHLBSC
 Set of 2 M8 eyebolts	NSYAELYTCRG8

Door accessories	References
 Steel door retainer for S3DC steel enclosure	NSYAEDRSCST
 Door switch for wall-mounted enclosures	NSYINLCRN
 Grounding lead 160, sec. 6 mm ²	NSYEL166D8

 See also these accessories

Equipment mounting plate Page 240	Accessories for mounting plate Page 242	Cable-management accessories Page 272
---	---	---

Technical changes reserved. Information provided without guarantee. Images are for illustrative purposes only.

Mounting plate					Accessories				
Microperforated mounting plate galvanized	Aluminum upright *	Perforated Telequick **	19" fixed chassis	19" pivoting chassis	Internal door	Adjustable brackets	Door cross-rail	Canopy	
NSYMF32	NSYMDVR3	NSYMR32	-	-	-	-	-	NSYTJ2015	
NSYMF33	NSYMDVR3	NSYMR33	-	-	-	-	-	NSYTJ3015	
NSYMF33	NSYMDVR3	NSYMR33	-	-	-	NSYSDCR200	-	NSYTJ3020	
NSYMF43	NSYMDVR4	NSYMR43	-	-	NSYPIN43	-	-	NSYTJ3015	
NSYMF43	NSYMDVR4	NSYMR43	-	-	NSYPIN43	NSYSDCR200	-	NSYTJ3020	
NSYMF44	NSYMDVR4	NSYMR44	-	-	-	NSYSDCR200	NSYTFPCR4	NSYTJ4020	
NSYMF54	NSYMDVR5	NSYMR54	-	-	NSYPIN54	NSYSDCR200	NSYTFPCR4	NSYTJ4020	
NSYMF54	NSYMDVR5	NSYMR54	-	-	NSYPIN54	NSYSDCR250	NSYTFPCR4	NSYTJ4025	
NSYMF55	NSYMDVR5	NSYMR55	-	-	-	NSYSDCR200	NSYTFPCR5	NSYTJ5020	
NSYMF55	NSYMDVR5	NSYMR55	-	-	-	NSYSDCR250	NSYTFPCR5	NSYTJ5025	
NSYMF64	NSYMDVR6	NSYMR64	-	-	NSYPIN64	NSYSDCR200	NSYTFPCR4	NSYTJ4020	
NSYMF64	NSYMDVR6	NSYMR64	-	-	NSYPIN64	NSYSDCR250	NSYTFPCR4	NSYTJ4025	
NSYMF66	NSYMDVR6	NSYMR66	NSYVDM12UF	NSYVDM11UP	-	NSYSDCR200	NSYTFPCR6	NSYTJ6020	
NSYMF66	NSYMDVR6	NSYMR66	NSYVDM12UF	NSYVDM11UP	-	NSYSDCR250	NSYTFPCR6	NSYTJ6025	
NSYMF66	NSYMDVR6	NSYMR66	NSYVDM12UF	NSYVDM11UP	-	NSYSDCR300	NSYTFPCR6	NSYTJ6030	
NSYMF75	NSYMDVR7	NSYMR75	-	-	NSYPIN75	NSYSDCR250	NSYTFPCR5	NSYTJ5025	
NSYMF86	NSYMDVR8	NSYMR86	NSYVDM17UF	NSYVDM16UP	NSYPIN86	NSYSDCR200	NSYTFPCR6	NSYTJ6020	
NSYMF86	NSYMDVR8	NSYMR86	NSYVDM17UF	NSYVDM16UP	NSYPIN86	NSYSDCR250	NSYTFPCR6	NSYTJ6025	
NSYMF86	NSYMDVR8	NSYMR86	NSYVDM17UF	NSYVDM16UP	NSYPIN86	NSYSDCR300	NSYTFPCR6	NSYTJ6030	
NSYMF86	NSYMDVR8	NSYMR86	NSYVDM17UF	NSYVDM16UP	NSYPIN86	NSYSDCR400	NSYTFPCR6	NSYTJ6040	
NSYMF88	NSYMDVR8	NSYMR88	-	-	-	NSYSDCR250	NSYTFPCR8	NSYTJ8025	
NSYMF88	NSYMDVR8	NSYMR88	-	-	-	NSYSDCR300	NSYTFPCR8	NSYTJ8030	
NSYMF106	NSYMDVR10	NSYMR106	NSYVDM21UF	NSYVDM20UP	NSYPIN106	NSYSDCR250	NSYTFPCR6	NSYTJ6025	
NSYMF108	NSYMDVR10	NSYMR108	-	NSYVDM20U8P	NSYPIN108	NSYSDCR250	NSYTFPCR8	NSYTJ8025	
NSYMF108	NSYMDVR10	NSYMR108	-	NSYVDM20U8P	NSYPIN108	NSYSDCR300	NSYTFPCR8	NSYTJ8030	
NSYMF108	NSYMDVR10	NSYMR108	-	NSYVDM20U8P	NSYPIN108	NSYSDCR400	NSYTFPCR8	NSYTJ8040	
NSYMF1010	NSYMDVR10	NSYMR1010	-	-	-	NSYSDCR300	NSYTFPCR10	NSYTJ10030	
NSYMF128	NSYMDVR12	NSYMR128	-	NSYVDM25U8P	NSYPIN128	NSYSDCR300	NSYTFPCR8	NSYTJ8030	
NSYMF128	NSYMDVR12	NSYMR128	-	NSYVDM25U8P	NSYPIN128	NSYSDCR400	NSYTFPCR8	NSYTJ8040	
NSYMF1210	NSYMDVR12	NSYMR1210	-	-	-	NSYSDCR300	NSYTFPCR10	NSYTJ10030	

⁽¹⁾ NSYEMR mandatory.

⁽²⁾ NSYAMCSF mandatory for enclosure width > 1000.

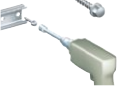
Mounting	References
 <p>Mounting for the grounding strip</p>	NSYEDCOS
 <p>Self-tapping screw for microperforated mounting plate</p>	NSYS13M5HS

CRN CRNG Steel Wall-Mounted Enclosures

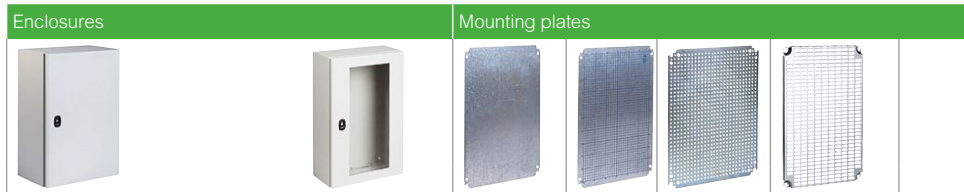









Dimensions			Enclosures				Mounting plates					
Height (A) mm (in.)	Width (B) mm (in.)	Depth (C) mm (in.)	Doors	IP	Weight kg (lbs.) ⁽¹⁾	with plain door, with mounting plate	with plain door, without mounting plate	with glazed door, with mounting plate	Plain	Silkscreened	Micro-perforated	Telequick
CRN steel wall-mounted enclosures												
200 (7.87)	200 (7.87)	150 (5.91)	1	66	2.5 (5.51)	-	NSYCRN22150P ⁽²⁾	-	NSYMM22	-	-	-
200 (7.87)	300 (11.81)	150 (5.91)	1	66	3.9 (8.60)	-	NSYCRN23150P ⁽²⁾	-	NSYMM32	-	NSYMF32	-
250 (9.84)	200 (7.87)	150 (5.91)	1	66	3.2 (7.05)	NSYCRN252150P	NSYCRN252150	-	NSYMM2520	-	-	-
300 (11.81)	250 (9.84)	150 (5.91)	1	66	4.2 (9.26)	NSYCRN325150P	NSYCRN325150	NSYCRN325150T	NSYMM3025	-	-	NSYMR3025
300 (11.81)	250 (9.84)	200 (7.87)	1	66	4.9 (10.80)	NSYCRN325200P	NSYCRN325200	NSYCRN325200T	NSYMM3025	-	-	NSYMR3025
300 (11.81)	300 (11.81)	150 (5.91)	1	66	5.0 (11.02)	NSYCRN33150P	NSYCRN33150	NSYCRN33150T	NSYMM33	-	NSYMF33	NSYMR33
300 (11.81)	300 (11.81)	200 (7.87)	1	66	6.0 (13.23)	NSYCRN33200P	NSYCRN33200	NSYCRN33200T	NSYMM33	-	NSYMF33	NSYMR33
300 (11.81)	400 (15.75)	200 (7.87)	1	66	6.4 (14.11)	-	NSYCRN34200	NSYCRN34200T	NSYMM43	NSYMS43	NSYMF43	NSYMR34
300 (11.81)	450 (17.72)	150 (5.91)	1	66	6.7 (14.77)	-	NSYCRN345150P ⁽²⁾	-	NSYMM3045	-	-	-
400 (15.75)	300 (11.81)	150 (5.91)	1	66	6.0 (13.23)	NSYCRN43150P	NSYCRN43150	NSYCRN43150T	NSYMM43	NSYMS43	NSYMF43	NSYMR43
400 (15.75)	300 (11.81)	200 (7.87)	1	66	6.8 (14.99)	NSYCRN43200P	NSYCRN43200	NSYCRN43200T	NSYMM43	NSYMS43	NSYMF43	NSYMR43
400 (15.75)	400 (15.75)	200 (7.87)	1	66	8.0 (17.64)	NSYCRN44200P	NSYCRN44200	NSYCRN44200T	NSYMM44	NSYMS44	NSYMF44	NSYMR44
400 (15.75)	600 (23.62)	250 (9.84)	1	66	10.0 (22.05)	NSYCRN46250P	NSYCRN46250	NSYCRN46250T	NSYMM64	NSYMS64	NSYMF64	NSYMR46
400 (15.75)	600 (23.62)	300 (11.81)	1	66	11.2 (24.69)	-	NSYCRN46300	NSYCRN46300T	NSYMM64	NSYMS64	NSYMF64	NSYMR46
500 (19.68)	400 (15.75)	150 (5.91)	1	66	8.7 (19.18)	NSYCRN54150P	NSYCRN54150	NSYCRN54150T	NSYMM54	NSYMS54	NSYMF54	NSYMR54
500 (19.68)	400 (15.75)	200 (7.87)	1	66	9.8 (21.61)	NSYCRN54200P	NSYCRN54200	NSYCRN54200T	NSYMM54	NSYMS54	NSYMF54	NSYMR54
500 (19.68)	400 (15.75)	250 (9.84)	1	66	11.0 (24.25)	NSYCRN54250P	NSYCRN54250	NSYCRN54250T	NSYMM54	NSYMS54	NSYMF54	NSYMR54
500 (19.68)	500 (19.68)	250 (9.84)	1	66	12.8 (28.22)	NSYCRN55250P	NSYCRN55250	NSYCRN55250T	NSYMM55	NSYMS55	NSYMF55	NSYMR55
600 (23.62)	400 (15.75)	150 (5.91)	1	66	9.3 (20.50)	NSYCRN64150P	NSYCRN64150	NSYCRN64150T	NSYMM64	NSYMS64	NSYMF64	NSYMR64
600 (23.62)	400 (15.75)	200 (7.87)	1	66	10.8 (23.81)	NSYCRN64200P	NSYCRN64200	NSYCRN64200T	NSYMM64	NSYMS64	NSYMF64	NSYMR64
600 (23.62)	400 (15.75)	250 (9.84)	1	66	12.3 (27.12)	NSYCRN64250P	NSYCRN64250	NSYCRN64250T	NSYMM64	NSYMS64	NSYMF64	NSYMR64
600 (23.62)	500 (19.68)	150 (5.91)	1	66	11.3 (24.91)	NSYCRN65150P	NSYCRN65150	NSYCRN65150T	NSYMM65	-	NSYMF65	NSYMR65
600 (23.62)	500 (19.68)	200 (7.87)	1	66	14.3 (31.53)	NSYCRN65200P	NSYCRN65200	NSYCRN65200T	NSYMM65	-	NSYMF65	NSYMR65
600 (23.62)	500 (19.68)	250 (9.84)	1	66	16.2 (35.71)	NSYCRN65250P	NSYCRN65250	NSYCRN65250T	NSYMM65	-	NSYMF65	NSYMR65
600 (23.62)	600 (23.62)	200 (7.87)	1	66	16.3 (35.94)	NSYCRN66200P	NSYCRN66200	NSYCRN66200T	NSYMM66	NSYMS66	NSYMF66	NSYMR66
600 (23.62)	600 (23.62)	250 (9.84)	1	66	18.2 (40.12)	NSYCRN66250P	NSYCRN66250	NSYCRN66250T	NSYMM66	NSYMS66	NSYMF66	NSYMR66
600 (23.62)	600 (23.62)	300 (11.81)	1	66	19.8 (43.65)	NSYCRN66300P	NSYCRN66300	NSYCRN66300T	NSYMM66	NSYMS66	NSYMF66	NSYMR66
600 (23.62)	800 (31.50)	300 (11.81)	1	66	26.0 (57.32)	-	NSYCRN68300	NSYCRN68300T	NSYMM86	NSYMS86	NSYMF86	NSYMR68
700 (27.56)	500 (19.68)	200 (7.87)	1	66	17.3 (38.14)	NSYCRN75200P	NSYCRN75200	NSYCRN75200T	NSYMM75	NSYMS75	NSYMF75	NSYMR75
700 (27.56)	500 (19.68)	250 (9.84)	1	66	19.3 (42.55)	NSYCRN75250P	NSYCRN75250	NSYCRN75250T	NSYMM75	NSYMS75	NSYMF75	NSYMR75
800 (31.50)	600 (23.62)	200 (7.87)	1	66	21.8 (48.06)	NSYCRN86200P	NSYCRN86200	NSYCRN86200T	NSYMM86	NSYMS86	NSYMF86	NSYMR86
800 (31.50)	600 (23.62)	250 (9.84)	1	66	24.8 (54.67)	NSYCRN86250P	NSYCRN86250	NSYCRN86250T	NSYMM86	NSYMS86	NSYMF86	NSYMR86
800 (31.50)	600 (23.62)	300 (11.81)	1	66	26.3 (57.98)	NSYCRN86300P	NSYCRN86300	NSYCRN86300T	NSYMM86	NSYMS86	NSYMF86	NSYMR86
800 (31.50)	800 (31.50)	200 (7.87)	1	66	29.5 (65.04)	NSYCRN88200P	NSYCRN88200	NSYCRN88200T	NSYMM88	-	NSYMF88	NSYMR88
800 (31.50)	800 (31.50)	300 (11.81)	1	66	32.5 (71.65)	NSYCRN88300P	NSYCRN88300	NSYCRN88300T	NSYMM88	-	NSYMF88	NSYMR88
1000 (39.37)	600 (23.62)	250 (9.84)	1	66	28.4 (62.61)	NSYCRN106250P	NSYCRN106250	NSYCRN106250T	NSYMM106	-	NSYMF106	NSYMR106
1000 (39.37)	600 (23.62)	300 (11.81)	1	66	30.6 (67.46)	NSYCRN106300P	NSYCRN106300	NSYCRN106300T	NSYMM106	-	NSYMF106	NSYMR106
1000 (39.37)	800 (31.50)	250 (9.84)	1	66	34.5 (76.06)	NSYCRN108250P	NSYCRN108250	NSYCRN108250T	NSYMM108	-	NSYMF108	NSYMR108
1000 (39.37)	800 (31.50)	300 (11.81)	1	66	37.4 (82.45)	NSYCRN108300P	NSYCRN108300	NSYCRN108300T	NSYMM108	-	NSYMF108	NSYMR108
CRNG Wall-mounted steel enclosures with three-point locking system												
800 (31.50)	600 (23.62)	400 (15.75)	1	66	30.0	-	NSYCRNG86400	NSYCRNG86400T	NSYMM86	NSYMS86	NSYMF86	NSYMR86
800 (31.50)	1000 (39.37)	300 (11.81)	2	55	40.0	-	NSYCRNG810300D	-	NSYMM108	-	NSYMF108	NSYMR810
800 (31.50)	1200 (47.24)	300 (11.81)	2	55	46.0	-	NSYCRNG812300D	-	NSYMM128	-	NSYMF128	2 x NSYMR86*
1000 (39.37)	600 (23.62)	400 (15.75)	1	66	36.0	-	NSYCRNG106400T	NSYCRNG106400T	NSYMM106	-	NSYMF106	NSYMR106
1000 (39.37)	800 (31.50)	400 (15.75)	1	66	43.0	-	NSYCRNG108400	NSYCRNG108400T	NSYMM108	-	NSYMF108	NSYMR108
1000 (39.37)	1000 (39.37)	300 (11.81)	2 ⁽³⁾	55	47.0	-	NSYCRNG1010300D	NSYCRNG1010300T	NSYMM1010	-	NSYMF1010	NSYMR1010 ⁽⁶⁾
1000 (39.37)	1200 (47.24)	300 (11.81)	2	55	55.0	-	NSYCRNG1012300D	-	NSYMM1210	-	NSYMF1210	NSYMR1012 ⁽⁶⁾
1000 (39.37)	1200 (47.24)	400 (15.75)	2	55	60.0	-	NSYCRNG1012400D	-	NSYMM1210	-	NSYMF1210	NSYMR1012 ⁽⁶⁾
1200 (47.24)	600 (23.62)	300 (11.81)	1	66	37.0	-	NSYCRNG126300	NSYCRNG126300T	NSYMM126	-	NSYMF126	NSYMR126
1200 (47.24)	600 (23.62)	400 (15.75)	1	66	42.0	-	NSYCRNG126400	NSYCRNG126400T	NSYMM126	-	NSYMF126	NSYMR126
1200 (47.24)	800 (31.50)	300 (11.81)	1	66	45.0	-	NSYCRNG128300	NSYCRNG128300T	NSYMM128	-	NSYMF128	NSYMR128
1200 (47.24)	800 (31.50)	400 (15.75)	1	66	50.0	-	NSYCRNG128400	NSYCRNG128400T	NSYMM128	-	NSYMF128	NSYMR128
1200 (47.24)	1000 (39.37)	300 (11.81)	2	55	56.0	-	NSYCRNG1210300D	-	NSYMM1210	-	NSYMF1210	NSYMR1210 ⁽⁶⁾
1200 (47.24)	1000 (39.37)	400 (15.75)	2	55	61.0	-	NSYCRNG1210400D	-	NSYMM1210	-	NSYMF1210	NSYMR1210 ⁽⁶⁾
1200 (47.24)	1200 (47.24)	300 (11.81)	2	55	64.0	-	NSYCRNG1212300D	-	NSYMM1212	-	2 x NSYMF126*	2 x NSYMR126*
1200 (47.24)	1200 (47.24)	400 (15.75)	2	55	90.0	-	NSYCRNG1212400D	-	NSYMM1212	-	2 x NSYMF126*	2 x NSYMR126*
1400 (55.12)	1000 (39.37)	300 (11.81)	2	55	80.0	-	NSYCRNG1410300D	-	NSYMM1410	-	-	NSYMR1410 ⁽⁶⁾

⁽¹⁾ Enclosure without mounting plate.

⁽²⁾ Two cable gland plates, one on the top, one on the bottom.

⁽³⁾ Except glazed door in single-door.

⁽⁴⁾ With two holes.

				Cable entries					
									
Bakelite	DIN rail chassis	Aluminum vertical rails ⁽⁵⁾	Step slides	Fig.	Type of cable entry	Cable gland plate standard	Cable gland plate insulated	Cable-gland plate with FL cut-out	FlexiCable
-	-	-	-	1	0	NSYTLCRNO	-	-	-
NSYMB32	-	-	-	1	B	NSYTLCRNB	-	-	-
-	-	-	-	1	0	NSYTLCRNO	-	-	-
NSYMB3025	-	NSYMDVR3	-	1	A	NSYTLCRNA	NSYTSACRNA	-	-
NSYMB3025	-	NSYMDVR3	NSYSDCR200	1	A	NSYTLCRNA	NSYTSACRNA	-	-
NSYMB33	NSYMD33	NSYMDVR3	-	1	B	NSYTLCRNB	NSYTSACRNB	-	-
NSYMB33	NSYMD33	NSYMDVR3	NSYSDCR200	1	B	NSYTLCRNB	NSYTSACRNB	-	-
NSYMB43	-	NSYMDVR3	NSYSDCR200	1	C	NSYTLCRNC	NSYTSACRNC	-	-
NSYMB43	-	NSYMDVR3	-	1	B	NSYTLCRNB	NSYTSACRNB	-	-
NSYMB43	NSYMD43	NSYMDVR4	-	1	B	NSYTLCRNB	NSYTSACRNB	-	-
NSYMB43	NSYMD43	NSYMDVR4	NSYSDCR200	1	B	NSYTLCRNB	NSYTSACRNB	-	-
-	-	NSYMDVR4	NSYSDCR200	1	C	NSYTLCRNC	NSYTSACRNC	-	-
NSYMB64	-	NSYMDVR4	NSYSDCR250	1	D	NSYTLCRND	NSYTSACRND	-	-
NSYMB64	-	NSYMDVR4	NSYSDCR300	1	D	NSYTLCRND	NSYTSACRND	-	-
NSYMB54	NSYMD54	NSYMDVR5	-	2	B	NSYTLCRNB	NSYTSACRNB	-	-
NSYMB54	NSYMD54	NSYMDVR5	NSYSDCR200	2	C	NSYTLCRNC	NSYTSACRNC	-	-
NSYMB54	NSYMD54	NSYMDVR5	NSYSDCR250	2	C	NSYTLCRNC	NSYTSACRNC	-	-
-	-	NSYMDVR5	NSYSDCR250	2	D	NSYTLCRND	NSYTSACRND	-	-
NSYMB64	NSYMD64	NSYMDVR6	-	2	B	NSYTLCRNB	NSYTSACRNB	-	-
NSYMB64	NSYMD64	NSYMDVR6	NSYSDCR200	2	C	NSYTLCRNC	NSYTSACRNC	-	-
NSYMB64	NSYMD64	NSYMDVR6	NSYSDCR250	2	C	NSYTLCRNC	NSYTSACRNC	-	-
NSYMB65	-	NSYMDVR6	-	2	B	NSYTLCRNB	NSYTSACRNB	-	-
NSYMB65	-	NSYMDVR6	NSYSDCR200	2	D	NSYTLCRND	NSYTSACRND	-	-
NSYMB65	-	NSYMDVR6	NSYSDCR250	2	D	NSYTLCRND	NSYTSACRND	-	-
-	NSYMD66	NSYMDVR6	NSYSDCR200	2	D	NSYTLCRND	NSYTSACRND	-	-
-	NSYMD66	NSYMDVR6	NSYSDCR250	2	D	NSYTLCRND	NSYTSACRND	-	-
-	NSYMD66	NSYMDVR6	NSYSDCR300	2	D	NSYTLCRND	NSYTSACRND	-	-
-	-	NSYMDVR6	NSYSDCR300	2	E	NSYTLCRNC ⁽⁴⁾	NSYTSACRNC	-	-
NSYMB75	NSYMD75	NSYMDVR7	NSYSDCR200	2	D	NSYTLCRND	NSYTSACRND	-	-
NSYMB75	NSYMD75	NSYMDVR7	NSYSDCR250	2	D	NSYTLCRND	NSYTSACRND	-	-
NSYMB86	NSYMD86	NSYMDVR8	NSYSDCR200	2	D	NSYTLCRND	NSYTSACRND	-	-
NSYMB86	NSYMD86	NSYMDVR8	NSYSDCR250	2	D	NSYTLCRND	NSYTSACRND	-	-
NSYMB86	NSYMD86	NSYMDVR8	NSYSDCR300	2	D	NSYTLCRND	NSYTSACRND	-	-
-	-	NSYMDVR8	NSYSDCR200	2	E	NSYTLCRNC ⁽⁴⁾	NSYTSACRNC ⁽⁵⁾	-	-
-	-	NSYMDVR8	NSYSDCR300	2	E	NSYTLCRNC ⁽⁴⁾	NSYTSACRNC ⁽⁵⁾	-	-
NSYMB106	-	NSYMDVR10	NSYSDCR250	2	D	NSYTLCRND	NSYTSACRND	-	-
NSYMB106	-	NSYMDVR10	NSYSDCR300	2	D	NSYTLCRND	NSYTSACRND	-	-
NSYMB108	NSYMD108	NSYMDVR10	NSYSDCR250	2	E	NSYTLCRNC ⁽⁴⁾	NSYTSACRNC ⁽⁵⁾	-	-
NSYMB108	NSYMD108	NSYMDVR10	NSYSDCR300	2	E	NSYTLCRNC ⁽⁴⁾	NSYTSACRNC ⁽⁵⁾	-	-
NSYMB86	NSYMD86	NSYMDVR8	NSYSDCR400	3	G	NSYTLG	-	NSYTLG2FL	NSYTLGME
-	-	NSYMDVR8	NSYSDCR300	4	H	NSYTL	-	NSYTL2FL	2 x NSYTLME
-	-	-	NSYSDCR300	4	H	NSYTL	-	NSYTL2FL	2 x NSYTLME
NSYMB106	-	NSYMDVR10	NSYSDCR400	3	G	NSYTLG	-	NSYTLG2FL	NSYTLGME
NSYMB108	NSYMD108	NSYMDVR10	NSYSDCR400	4	H	NSYTL	-	NSYTL2FL	2 x NSYTLME
NSYMB1210	-	NSYMDVR10	NSYSDCR300	4	H	NSYTL	-	NSYTL2FL	2 x NSYTLME
NSYMB1210	-	NSYMDVR10	NSYSDCR300	4	H	NSYTL	-	NSYTL2FL	2 x NSYTLME
-	-	NSYMDVR10	NSYSDCR400	4	H	NSYTL	-	NSYTL2FL	2 x NSYTLME
-	-	NSYMDVR12	NSYSDCR300	3	G	NSYTLG	-	NSYTLG2FL	NSYTLGME
-	-	NSYMDVR12	NSYSDCR400	3	G	NSYTLG	-	NSYTLG2FL	NSYTLGME
-	NSYMD128	NSYMDVR12	NSYSDCR300	4	H	NSYTL	-	NSYTL2FL	2 x NSYTLME
-	NSYMD128	NSYMDVR12	NSYSDCR400	4	H	NSYTL	-	NSYTL2FL	2 x NSYTLME
NSYMB1210	-	NSYMDVR12	NSYSDCR300	4	H	NSYTL	-	NSYTL2FL	2 x NSYTLME
NSYMB1210	-	NSYMDVR12	NSYSDCR400	4	H	NSYTL	-	NSYTL2FL	2 x NSYTLME
-	-	NSYMDVR12	NSYSDCR300	4	H	NSYTL	-	NSYTL2FL	2 x NSYTLME
-	-	NSYMDVR12	NSYSDCR400	4	H	NSYTL	-	NSYTL2FL	2 x NSYTLME
-	-	-	NSYSDCR300	4	H	NSYTL	-	NSYTL2FL	2 x NSYTLME

⁽⁵⁾ Flange openings of type E require two NSYTSACRNC.

⁽⁶⁾ Ref. NSYEMR mandatory.

⁽⁷⁾ Order NSYAMCSF, NSYMDVR12 in steel.

Not compatible with double mounting plate.

Applicative Solutions

Basic enclosures
Empty application enclosures

Basic enclosures
19" enclosure with glazed door (Plain door, please consult us.)







Dimensions			Doors	IP	S3DB terminal enclosures	VDM steel enclosures with 19" swing rack	No. of U	1-body 19" fixed rack	No. of U	2 parts with 19" fixed rack	No. of U
Height mm (in.)	Width mm (in.)	Depth mm (in.)									
200 (7.87)	300 (11.81)	150 (5.91)	1	66	-	-	-	-	-	-	-
250 (9.84)	300 (11.81)	150 (5.91)	1	66	NSYS3DB25315	-	-	-	-	-	-
250 (9.84)	400 (15.75)	150 (5.91)	1	66	NSYS3DB25415	-	-	-	-	-	-
250 (9.84)	500 (19.68)	150 (5.91)	1	66	NSYS3DB25515	-	-	-	-	-	-
300 (11.81)	300 (11.81)	150 (5.91)	1	66	NSYS3DB3315	-	-	-	-	-	-
300 (11.81)	300 (11.81)	170 (6.69)	1	66	-	-	-	-	-	-	-
300 (11.81)	400 (15.75)	150 (5.91)	1	66	NSYS3DB3415	-	-	-	-	-	-
300 (11.81)	400 (15.75)	170 (6.69)	1	66	-	-	-	-	-	-	-
300 (11.81)	500 (19.68)	150 (5.91)	1	66	NSYS3DB3515	-	-	-	-	-	-
300 (11.81)	500 (19.68)	200 (7.87)	1	66	-	-	-	-	-	-	-
300 (11.81)	600 (23.62)	150 (5.91)	1	66	NSYS3DB3615	-	-	-	-	-	-
300 (11.81)	600 (23.62)	400 (15.75)	1	66	-	NSYVDM4U4P	4	NSYVDM5U4F	5	NSYVD2M5U4	5
300 (11.81)	600 (23.62)	500 (19.68)	1	66	-	-	-	-	-	NSYVD2M5U5	5
400 (15.75)	300 (11.81)	150 (5.91)	1	66	NSYS3DB4315	-	-	-	-	-	-
400 (15.75)	300 (11.81)	170 (6.69)	1	66	-	-	-	-	-	-	-
400 (15.75)	600 (23.62)	400 (15.75)	1	66	-	NSYVDM7U4P	7	NSYVDM8U4F	8	NSYVD2M8U4	8
400 (15.75)	600 (23.62)	500 (19.68)	1	66	-	-	-	-	-	NSYVD2M8U5	8
400 (15.75)	800 (31.50)	150 (5.91)	1	66	NSYS3DB4815	-	-	-	-	-	-
500 (19.68)	400 (15.75)	150 (5.91)	1	66	NSYS3DB5415	-	-	-	-	-	-
500 (19.68)	600 (23.62)	400 (15.75)	1	66	-	NSYVDM9U4P	9	NSYVDM10U4F	10	NSYVD2M10U4	10
500 (19.68)	600 (23.62)	500 (19.68)	1	66	-	-	-	-	-	NSYVD2M10U5	10
600 (23.62)	400 (15.75)	150 (5.91)	1	66	NSYS3DB6415	-	-	-	-	-	-
600 (23.62)	600 (23.62)	150 (5.91)	1	66	-	-	-	-	-	-	-
700 (27.56)	500 (19.68)	150 (5.91)	1	66	-	-	-	-	-	-	-
700 (27.56)	500 (19.68)	150 (5.91)	1	66	-	-	-	-	-	-	-
700 (27.56)	600 (23.62)	400 (15.75)	1	66	-	NSYVDM13U4P	13	NSYVDM14U4F	14	NSYVD2M14U4	14
700 (27.56)	600 (23.62)	500 (19.68)	1	66	-	-	-	-	-	NSYVD2M14U5	14
800 (31.50)	600 (23.62)	150 (5.91)	1	66	-	-	-	-	-	-	-
800 (31.50)	600 (23.62)	150 (5.91)	1	66	-	-	-	-	-	-	-
800 (31.50)	600 (23.62)	400 (15.75)	1	66	-	NSYVDM16U4P	16	NSYVDM17U4F	17	NSYVD2M17U4	17
800 (31.50)	600 (23.62)	500 (19.68)	1	66	-	-	-	-	-	NSYVD2M17U5	17
1000 (39.37)	600 (23.62)	150 (5.91)	1	66	-	-	-	-	-	-	-
1000 (39.37)	800 (31.50)	150 (5.91)	1	66	-	-	-	-	-	-	-
Details					see page 359			see page 359		see page 359	





Wall fixing lugs: [Page 64](#)
Steel: **NSYAEFPFSC**
Stainless-steel: **NSYAEFPFXSC**

Reinforcement for heavy loads: [Page 64](#)
NSYAEFAHLBSC
Locking accessories: [Page 86](#)

Door accessories: [Page 298](#)
Clip-on nuts: [Page 270](#)
Self-tapping screw: **NSYS13M5HS** / [Page 271](#)

Accessories Automatism				
				
DIN rail support and DIN rail	Plain mounting plate	Telequick mounting plate	Aluminum vertical rails	
NSYAMRD2030	NSYMM32	-	-	-
NSYAMRD2530	NSYMM3025	-	-	-
NSYAMRD2540	NSYMM2540	-	-	-
NSYAMRD2550	NSYMM2550	-	-	-
NSYAMRD3030	NSYMM33	NSYMR33	NSYMDVR3	-
NSYAMRD3030	NSYMM33	NSYMR33	-	-
NSYAMRD3040	NSYMM43	NSYMR34	NSYMDVR3	-
NSYAMRD3040	NSYMM43	NSYMR34	-	-
NSYAMRD3050	NSYMM53	-	NSYMDVR3	-
NSYAMRD3050	NSYMM53	-	NSYMDVR3	-
NSYAMRD36	NSYMM36	-	NSYMDVR3	-
NSYAMRD36	NSYMM36	-	NSYMDVR3	-
NSYAMRD36	NSYMM36	-	NSYMDVR3	-
NSYAMRD43	NSYMM43	NSYMR43	NSYMDVR4	-
NSYAMRD43	NSYMM43	NSYMR43	-	-
-	NSYMM64	NSYMR46	NSYMDVR4	-
NSYAMRD48	NSYMM64	NSYMR46	NSYMDVR4	-
NSYAMRD54	NSYMM48	-	NSYMDVR4	-
-	NSYMM54	NSYMR54	NSYMDVR5	-
-	NSYMM65	-	NSYMDVR5	-
-	NSYMM65	-	NSYMDVR5	-
NSYAMRD64	NSYMM64	NSYMR64	NSYMDVR6	-
-	NSYMM66	NSYMR66	NSYMDVR6	-
-	NSYMM75	NSYMR75	NSYMDVR7	-
-	NSYMM75	NSYMR75	NSYMDVR7	-
-	NSYMM76	NSYMR76	NSYMDVR7	-
-	NSYMM76	NSYMR76	NSYMDVR7	-
-	NSYMM86	NSYMR86	NSYMDVR8	-
-	NSYMM86	NSYMR86	NSYMDVR8	-
-	NSYMM86	NSYMR86	NSYMDVR8	-
-	NSYMM86	NSYMR86	NSYMDVR8	-
-	NSYMM86	NSYMR86	NSYMDVR8	-
-	NSYMM106	NSYMR106	NSYMDVR10	-
-	NSYMM108	NSYMR108	NSYMDVR10	-
	see page 240	see page 240	see page 244	

Technical changes reserved. Information provided without guarantee. Images are for illustrative purposes only.

Dimensions			Enclosures			Plinth (H 100 (3.94) mm (in.))		
Height mm (in.)	Width mm (in.)	Depth mm (in.)	Doors					
				Plain door, without mounting plate	Plain door, with mounting plate	Transparent door, without mounting plate	Front kit (corners + front panels)	Side panels, 2 u.
1200 (47.24)	800 (31.50)	300 (11.81)	1	NSYSM12830	NSYSM12830P	-	NSYSPPF8100	NSYSPPS3100
1200 (47.24)	1000 (39.37)	300 (11.81)	2	NSYSM1210302D	NSYSM1210302DP	-	NSYSPPF10100	NSYSPPS3100
1200 (47.24)	1200 (47.24)	400 (15.75)	2	NSYSM1212402D	NSYSM1212402DP	-	NSYSPPF12100	NSYSPPS4100
1400 (55.12)	600 (23.62)	300 (11.81)	1	NSYSM14630	NSYSM14630P	-	NSYSPPF6100	NSYSPPS3100
1400 (55.12)	600 (23.62)	400 (15.75)	1	NSYSM14640	NSYSM14640P	-	NSYSPPF6100	NSYSPPS4100
1400 (55.12)	800 (31.50)	300 (11.81)	1	NSYSM14830	NSYSM14830P	-	NSYSPPF8100	NSYSPPS3100
1400 (55.12)	800 (31.50)	400 (15.75)	1	NSYSM14840	NSYSM14840P	NSYSM14840T	NSYSPPF8100	NSYSPPS4100
1400 (55.12)	1000 (39.37)	400 (15.75)	2	NSYSM1410402D	NSYSM1410402DP	-	NSYSPPF10100	NSYSPPS4100
1400 (55.12)	1200 (47.24)	400 (15.75)	2	NSYSM1412402D	NSYSM1412402DP	-	NSYSPPF12100	NSYSPPS4100
1600 (62.99)	600 (23.62)	300 (11.81)	1	NSYSM16630	NSYSM16630P	-	NSYSPPF6100	NSYSPPS3100
1600 (62.99)	600 (23.62)	400 (15.75)	1	NSYSM16640	NSYSM16640P	NSYSM16640T	NSYSPPF6100	NSYSPPS4100
1600 (62.99)	800 (31.50)	300 (11.81)	1	NSYSM16830	NSYSM16830P	NSYSM16830T	NSYSPPF8100	NSYSPPS3100
1600 (62.99)	800 (31.50)	400 (15.75)	1	NSYSM16840	NSYSM16840P	NSYSM16840T	NSYSPPF8100	NSYSPPS4100
1600 (62.99)	1000 (39.37)	300 (11.81)	2	NSYSM1610302D	NSYSM1610302DP	-	NSYSPPF10100	NSYSPPS3100
1600 (62.99)	1000 (39.37)	400 (15.75)	2	NSYSM1610402D	NSYSM1610402DP	-	NSYSPPF10100	NSYSPPS4100
1600 (62.99)	1200 (47.24)	300 (11.81)	2	NSYSM1612302D	NSYSM1612302DP	-	NSYSPPF12100	NSYSPPS3100
1600 (62.99)	1200 (47.24)	400 (15.75)	2	NSYSM1612402D	NSYSM1612402DP	-	NSYSPPF12100	NSYSPPS4100
1800 (70.87)	600 (23.62)	300 (11.81)	1	NSYSM18630	NSYSM18630P	-	NSYSPPF6100	NSYSPPS3100
1800 (70.87)	600 (23.62)	400 (15.75)	1	NSYSM18640	NSYSM18640P	NSYSM18640T	NSYSPPF6100	NSYSPPS4100
1800 (70.87)	600 (23.62)	500 (19.68)	1	NSYSM18650	NSYSM18650P	-	NSYSPPF6100	NSYSPPS5100
1800 (70.87)	800 (31.50)	300 (11.81)	1	NSYSM18830	NSYSM18830P	NSYSM18830T	NSYSPPF8100	NSYSPPS3100
1800 (70.87)	800 (31.50)	400 (15.75)	1	NSYSM18840	NSYSM18840P	NSYSM18840T	NSYSPPF8100	NSYSPPS4100
1800 (70.87)	800 (31.50)	500 (19.68)	1	NSYSM18850	NSYSM18850P	NSYSM18850T	NSYSPPF8100	NSYSPPS5100
1800 (70.87)	800 (31.50)	600 (23.62)	1	NSYSM18860	NSYSM18860P	-	NSYSPPF8100	NSYSPPS6100
1800 (70.87)	1000 (39.37)	400 (15.75)	1	NSYSM181040	NSYSM181040P	-	NSYSPPF10100	NSYSPPS4100
1800 (70.87)	1000 (39.37)	400 (15.75)	2	NSYSM1810402D	NSYSM1810402DP	-	NSYSPPF10100	NSYSPPS4100
1800 (70.87)	1000 (39.37)	500 (19.68)	2	NSYSM1810502D	NSYSM1810502DP	-	NSYSPPF10100	NSYSPPS5100
1800 (70.87)	1200 (47.24)	400 (15.75)	2	NSYSM1812402D	NSYSM1812402DP	-	NSYSPPF12100	NSYSPPS4100
1800 (70.87)	1200 (47.24)	500 (19.68)	2	NSYSM1812502D	NSYSM1812502DP	-	NSYSPPF12100	NSYSPPS5100
1800 (70.87)	1600 (62.99)	400 (15.75)	2	NSYSM1816402D	NSYSM1816402DP	-	NSYSPPF16100	NSYSPPS4100
1800 (70.87)	1600 (62.99)	500 (19.68)	2	NSYSM1816502D	NSYSM1816502DP	-	NSYSPPF16100	NSYSPPS5100
2000 (78.74)	600 (23.62)	300 (11.81)	1	NSYSM20630	NSYSM20630P	-	NSYSPPF6100	NSYSPPS3100
2000 (78.74)	600 (23.62)	400 (15.75)	1	NSYSM20640	NSYSM20640P	NSYSM20640T	NSYSPPF6100	NSYSPPS4100
2000 (78.74)	600 (23.62)	500 (19.68)	1	NSYSM20650	NSYSM20650P	-	NSYSPPF6100	NSYSPPS5100
2000 (78.74)	800 (31.50)	300 (11.81)	1	NSYSM20830	NSYSM20830P	NSYSM20830T	NSYSPPF8100	NSYSPPS3100
2000 (78.74)	800 (31.50)	400 (15.75)	1	NSYSM20840	NSYSM20840P	NSYSM20840T	NSYSPPF8100	NSYSPPS4100
2000 (78.74)	800 (31.50)	500 (19.68)	1	NSYSM20850	NSYSM20850P	NSYSM20850T	NSYSPPF8100	NSYSPPS5100
2000 (78.74)	800 (31.50)	600 (23.62)	1	NSYSM20860	NSYSM20860P	NSYSM20860T	NSYSPPF8100	NSYSPPS6100
2000 (78.74)	1000 (39.37)	400 (15.75)	2	NSYSM2010402D	NSYSM2010402DP	-	NSYSPPF10100	NSYSPPS4100
2000 (78.74)	1000 (39.37)	500 (19.68)	2	NSYSM2010502D	NSYSM2010502DP	-	NSYSPPF10100	NSYSPPS5100
2000 (78.74)	1200 (47.24)	400 (15.75)	2	NSYSM2012402D	NSYSM2012402DP	-	NSYSPPF12100	NSYSPPS4100
2000 (78.74)	1200 (47.24)	500 (19.68)	2	NSYSM2012502D	NSYSM2012502DP	-	NSYSPPF12100	NSYSPPS5100
2000 (78.74)	1200 (47.24)	600 (23.62)	2	NSYSM2012602D	NSYSM2012602DP	-	NSYSPPF12100	NSYSPPS6100
2000 (78.74)	1600 (62.99)	400 (15.75)	2	NSYSM2016402D	NSYSM2016402DP	-	NSYSPPF16100	NSYSPPS4100
2000 (78.74)	1600 (62.99)	500 (19.68)	2	NSYSM2016502D	NSYSM2016502DP	-	NSYSPPF16100	NSYSPPS5100
2000 (78.74)	1600 (62.99)	600 (23.62)	2	NSYSM2016602D	NSYSM2016602DP	-	NSYSPPF16100	NSYSPPS6100

Plinth (H 200 (7.87) mm (in.))		Inner door	Mounting plate	Vertical uprights		19" swing rack	
Front kit (corners + front panels)	Side panels, 4 u.	Plain door	Galvanized	Standard	Technical	Off-center	Centered
NSYSPF8200	NSYSPS3200	-	NSYMP128	-	NSYTVR12	-	-
NSYSPF10200	NSYSPS3200	-	NSYMP1210	-	NSYTVR12	-	-
NSYSPF12200	NSYSPS4200	-	NSYMP1212	-	NSYTVR12	-	-
NSYSPF6200	NSYSPS3200	-	NSYMP146	-	NSYTVR14	-	-
NSYSPF6200	NSYSPS4200	-	NSYMP146	-	NSYTVR14	-	-
NSYSPF8200	NSYSPS3200	-	NSYMP148	-	NSYTVR14	NSYRSW27	NSYRSWC27
NSYSPF8200	NSYSPS4200	-	NSYMP148	-	NSYTVR14	NSYRSW27	NSYRSWC27
NSYSPF10200	NSYSPS4200	-	NSYMP1410	-	NSYTVR14	-	-
NSYSPF12200	NSYSPS4200	-	NSYMP1412	-	NSYTVR14	-	-
NSYSPF6200	NSYSPS3200	NSYID166	NSYMP166	-	NSYTVR16	-	-
NSYSPF6200	NSYSPS4200	NSYID166	NSYMP166	-	NSYTVR16	-	-
NSYSPF8200	NSYSPS3200	NSYID168	NSYMP168	-	NSYTVR16	NSYRSW31	NSYRSWC31
NSYSPF8200	NSYSPS4200	NSYID168	NSYMP168	-	NSYTVR16	NSYRSW31	NSYRSWC31
NSYSPF10200	NSYSPS3200	-	NSYMP1610	-	NSYTVR16	-	-
NSYSPF10200	NSYSPS4200	-	NSYMP1610	-	NSYTVR16	-	-
NSYSPF12200	NSYSPS3200	-	NSYMP1612	-	NSYTVR16	-	-
NSYSPF12200	NSYSPS4200	-	NSYMP1612	-	NSYTVR16	-	-
NSYSPF6200	NSYSPS3200	NSYID186	NSYMP186	NSYVR18	NSYTVR18	-	-
NSYSPF6200	NSYSPS4200	NSYID186	NSYMP186	NSYVR18	NSYTVR18	-	-
NSYSPF6200	NSYSPS5200	NSYID186	NSYMP186	NSYVR18	NSYTVR18	-	-
NSYSPF8200	NSYSPS3200	NSYID188	NSYMP188	NSYVR18	NSYTVR18	NSYRSW36	NSYRSWC36
NSYSPF8200	NSYSPS4200	NSYID188	NSYMP188	NSYVR18	NSYTVR18	NSYRSW36	NSYRSWC36
NSYSPF8200	NSYSPS5200	NSYID188	NSYMP188	NSYVR18	NSYTVR18	NSYRSW36	NSYRSWC36
NSYSPF8200	NSYSPS6200	NSYID188	NSYMP188	NSYVR18	NSYTVR18	NSYRSW36	NSYRSWC36
NSYSPF10200	NSYSPS4200	NSYID1810	NSYMP1810	NSYVR18	NSYTVR18	-	-
NSYSPF10200	NSYSPS4200	NSYID1810	NSYMP1810	NSYVR18	NSYTVR18	-	-
NSYSPF10200	NSYSPS5200	NSYID1810	NSYMP1810	NSYVR18	NSYTVR18	-	-
NSYSPF12200	NSYSPS4200	-	NSYMP1812	NSYVR18	NSYTVR18	-	-
NSYSPF12200	NSYSPS5200	-	NSYMP1812	NSYVR18	NSYTVR18	-	-
NSYSPF16200	NSYSPS4200	-	NSYMP1816	NSYVR18	NSYTVR18	-	-
NSYSPF16200	NSYSPS5200	-	NSYMP1816	NSYVR18	NSYTVR18	-	-
NSYSPF6200	NSYSPS3200	NSYID206	NSYMP206	NSYVR20	NSYTVR20	-	-
NSYSPF6200	NSYSPS4200	NSYID206	NSYMP206	NSYVR20	NSYTVR20	-	-
NSYSPF6200	NSYSPS5200	NSYID206	NSYMP206	NSYVR20	NSYTVR20	-	-
NSYSPF8200	NSYSPS3200	NSYID208	NSYMP208	NSYVR20	NSYTVR20	NSYRSW40	NSYRSWC40
NSYSPF8200	NSYSPS4200	NSYID208	NSYMP208	NSYVR20	NSYTVR20	NSYRSW40	NSYRSWC40
NSYSPF8200	NSYSPS5200	NSYID208	NSYMP208	NSYVR20	NSYTVR20	NSYRSW40	NSYRSWC40
NSYSPF8200	NSYSPS6200	NSYID208	NSYMP208	NSYVR20	NSYTVR20	NSYRSW40	NSYRSWC40
NSYSPF10200	NSYSPS4200	NSYID2010	NSYMP2010	NSYVR20	NSYTVR20	-	-
NSYSPF10200	NSYSPS5200	NSYID2010	NSYMP2010	NSYVR20	NSYTVR20	-	-
NSYSPF12200	NSYSPS4200	-	NSYMP2012	NSYVR20	NSYTVR20	-	-
NSYSPF12200	NSYSPS5200	-	NSYMP2012	NSYVR20	NSYTVR20	-	-
NSYSPF12200	NSYSPS6200	-	NSYMP2012	NSYVR20	NSYTVR20	-	-
NSYSPF16200	NSYSPS4200	-	NSYMP2016	NSYVR20	NSYTVR20	-	-
NSYSPF16200	NSYSPS5200	-	NSYMP2016	NSYVR20	NSYTVR20	-	-
NSYSPF16200	NSYSPS6200	-	NSYMP2016	NSYVR20	NSYTVR20	-	-

Technical changes reserved. Information provided without guarantee. Images are for illustrative purposes only.

SF Steel Floor-Standing Enclosures

Dimensions			Enclosures				Side panels	Cable entry plates		
(A)	(B)	(C)	Doors	Plain door, without mounting plate	Plain door, with mounting plate	Transparent door, without mounting plate	Plain	Plain	1 entry	2 entries
Height mm (in.)	Width mm (in.)	Depth mm (in.)								
1200 (47.24)	600 (23.62)	400 (15.75)	1	NSYSF12640	NSYSF12640P	-	NSY2SP124	NSYEC64	NSYEC641	-
1200 (47.24)	600 (23.62)	600 (23.62)	1	NSYSF12660	NSYSF12660P	-	NSY2SP126	NSYEC66	NSYEC661	NSYEC662
1200 (47.24)	800 (31.50)	400 (15.75)	1	NSYSF12840	NSYSF12840P	-	NSY2SP124	NSYEC84	NSYEC841	-
1200 (47.24)	800 (31.50)	600 (23.62)	1	NSYSF12860	NSYSF12860P	-	NSY2SP126	NSYEC86	NSYEC861	NSYEC862
1400 (55.12)	600 (23.62)	400 (15.75)	1	NSYSF14640	NSYSF14640P	-	NSY2SP144	NSYEC64	NSYEC641	-
1400 (55.12)	800 (31.50)	400 (15.75)	1	NSYSF14840	NSYSF14840P	-	NSY2SP144	NSYEC84	NSYEC841	-
1600 (62.99)	600 (23.62)	600 (23.62)	1	NSYSF16660	NSYSF16660P	-	NSY2SP166	NSYEC66	NSYEC661	NSYEC662
1600 (62.99)	600 (23.62)	800 (31.50)	1	NSYSF16680	NSYSF16680P	-	NSY2SP168	NSYEC68	NSYEC681	NSYEC682
1600 (62.99)	800 (31.50)	600 (23.62)	1	NSYSF16860	NSYSF16860P	-	NSY2SP166	NSYEC86	NSYEC861	NSYEC862
1600 (62.99)	800 (31.50)	800 (31.50)	1	NSYSF16880	NSYSF16880P	-	NSY2SP168	NSYEC88	NSYEC881	NSYEC882
1800 (70.87)	400 (15.75)	400 (15.75)	1	NSYSF18440	-	-	NSY2SP184	NSYEC44	NSYEC441	-
1800 (70.87)	400 (15.75)	500 (19.68)	1	NSYSF18450	-	-	NSY2SP185	NSYEC45	NSYEC451	-
1800 (70.87)	400 (15.75)	600 (23.62)	1	NSYSF18460	-	-	NSY2SP186	-	NSYEC461	NSYEC462
1800 (70.87)	600 (23.62)	400 (15.75)	1	NSYSF18640	NSYSF18640P	NSYSF18640T	NSY2SP184	NSYEC64	NSYEC641	-
1800 (70.87)	600 (23.62)	500 (19.68)	1	NSYSF18650	NSYSF18650P	NSYSF18650T	NSY2SP185	NSYEC65	NSYEC651	-
1800 (70.87)	600 (23.62)	600 (23.62)	1	NSYSF18660	NSYSF18660P	-	NSY2SP186	NSYEC66	NSYEC661	NSYEC662
1800 (70.87)	600 (23.62)	800 (31.50)	1	-	-	NSYSF18680T	NSY2SP188	NSYEC68	NSYEC681	NSYEC682
1800 (70.87)	800 (31.50)	400 (15.75)	1	NSYSF18840	NSYSF18840P	NSYSF18840T	NSY2SP184	NSYEC84	NSYEC841	-
1800 (70.87)	800 (31.50)	500 (19.68)	1	NSYSF18850	NSYSF18850P	NSYSF18850T	NSY2SP185	NSYEC85	NSYEC851	-
1800 (70.87)	800 (31.50)	600 (23.62)	1	NSYSF18860	NSYSF18860P	NSYSF18860T	NSY2SP186	NSYEC86	NSYEC861	NSYEC862
1800 (70.87)	800 (31.50)	600 (23.62)	2	NSYSF188602D	NSYSF188602DP	-	NSY2SP186	NSYEC86	NSYEC861	NSYEC862
1800 (70.87)	1000 (39.37)	400 (15.75)	1	NSYSF181040	NSYSF181040P	-	NSY2SP184	NSYEC104	NSYEC1041	-
1800 (70.87)	1000 (39.37)	400 (15.75)	2	NSYSF1810402D	NSYSF1810402DP	-	NSY2SP184	NSYEC104	NSYEC1041	-
1800 (70.87)	1000 (39.37)	500 (19.68)	1	NSYSF181050	NSYSF181050P	-	NSY2SP185	NSYEC105	NSYEC1051	-
1800 (70.87)	1000 (39.37)	600 (23.62)	1	NSYSF181060	NSYSF181060P	-	NSY2SP186	NSYEC106	NSYEC1061	NSYEC1062
1800 (70.87)	1000 (39.37)	600 (23.62)	2	NSYSF1810602D	NSYSF1810602DP	-	NSY2SP186	NSYEC106	NSYEC1061	NSYEC1062
1800 (70.87)	1200 (47.24)	400 (15.75)	2	NSYSF1812402D	NSYSF1812402DP	-	NSY2SP184	NSYEC124	NSYEC1241	-
1800 (70.87)	1200 (47.24)	500 (19.68)	2	NSYSF1812502D	NSYSF1812502DP	-	NSY2SP185	NSYEC125	NSYEC1251	-
1800 (70.87)	1200 (47.24)	600 (23.62)	2	NSYSF1812602D	NSYSF1812602DP	-	NSY2SP186	NSYEC126	NSYEC1261	NSYEC1262
2000 (78.74)	300 (11.81)	500 (19.68)	1	NSYSF20350	-	-	NSY2SP205	NSYEC35	NSYEC351	-
2000 (78.74)	300 (11.81)	600 (23.62)	1	NSYSF20360	-	-	NSY2SP206	NSYEC36	NSYEC361	-
2000 (78.74)	300 (11.81)	800 (31.50)	1	NSYSF20380	-	-	NSY2SP208	-	NSYEC381	-
2000 (78.74)	400 (15.75)	400 (15.75)	1	NSYSF20440	-	-	NSY2SP204	NSYEC44	NSYEC441	-
2000 (78.74)	400 (15.75)	500 (19.68)	1	NSYSF20450	-	-	NSY2SP205	NSYEC45	NSYEC451	-
2000 (78.74)	400 (15.75)	600 (23.62)	1	NSYSF20460	-	-	NSY2SP206	NSYEC64	NSYEC461	NSYEC462
2000 (78.74)	400 (15.75)	800 (31.50)	1	NSYSF20480	-	-	NSY2SP208	NSYEC84	NSYEC481	NSYEC482
2000 (78.74)	600 (23.62)	400 (15.75)	1	NSYSF20640	NSYSF20640P	NSYSF20640T	NSY2SP204	NSYEC64	NSYEC641	-
2000 (78.74)	600 (23.62)	500 (19.68)	1	NSYSF20650	NSYSF20650P	NSYSF20650T	NSY2SP205	NSYEC65	NSYEC651	-
2000 (78.74)	600 (23.62)	600 (23.62)	1	NSYSF20660	NSYSF20660P	-	NSY2SP206	NSYEC66	NSYEC661	NSYEC662
2000 (78.74)	600 (23.62)	800 (31.50)	1	NSYSF20680	NSYSF20680P	-	NSY2SP208	NSYEC68	NSYEC681	NSYEC682
2000 (78.74)	800 (31.50)	400 (15.75)	1	NSYSF20840	NSYSF20840P	NSYSF20840T	NSY2SP204	NSYEC84	NSYEC841	-
2000 (78.74)	800 (31.50)	500 (19.68)	1	NSYSF20850	NSYSF20850P	NSYSF20850T	NSY2SP205	NSYEC85	NSYEC851	-
2000 (78.74)	800 (31.50)	600 (23.62)	1	NSYSF20860	NSYSF20860P	NSYSF20860T	NSY2SP206	NSYEC86	NSYEC861	NSYEC862
2000 (78.74)	800 (31.50)	600 (23.62)	2	NSYSF208602D	NSYSF208602DP	-	NSY2SP206	NSYEC86	NSYEC861	NSYEC862
2000 (78.74)	800 (31.50)	800 (31.50)	1	NSYSF20880	NSYSF20880P	NSYSF20880T	NSY2SP208	NSYEC88	NSYEC881	NSYEC882
2000 (78.74)	1000 (39.37)	400 (15.75)	1	NSYSF201040	NSYSF201040P	NSYSF201040T	NSY2SP204	NSYEC104	NSYEC1041	-
2000 (78.74)	1000 (39.37)	400 (15.75)	2	NSYSF2010402D	NSYSF2010402DP	-	NSY2SP204	NSYEC104	NSYEC1041	-
2000 (78.74)	1000 (39.37)	500 (19.68)	1	NSYSF201050	NSYSF201050P	NSYSF201050T	NSY2SP205	NSYEC105	NSYEC1051	-
2000 (78.74)	1000 (39.37)	500 (19.68)	2	NSYSF2010502D	NSYSF2010502DP	-	NSY2SP205	NSYEC105	NSYEC1051	-
2000 (78.74)	1000 (39.37)	600 (23.62)	1	NSYSF201060	NSYSF201060P	NSYSF201060T	NSY2SP206	NSYEC106	NSYEC1061	NSYEC1062
2000 (78.74)	1000 (39.37)	600 (23.62)	2	NSYSF2010602D	NSYSF2010602DP	-	NSY2SP206	NSYEC106	NSYEC1061	NSYEC1062
2000 (78.74)	1000 (39.37)	800 (31.50)	1	NSYSF201080	NSYSF201080P	-	NSY2SP208	NSYEC108	NSYEC1081	NSYEC1082
2000 (78.74)	1200 (47.24)	400 (15.75)	2	NSYSF2012402D	NSYSF2012402DP	-	NSY2SP204	NSYEC124	NSYEC1241	-
2000 (78.74)	1200 (47.24)	500 (19.68)	2	NSYSF2012502D	NSYSF2012502DP	-	NSY2SP205	NSYEC125	NSYEC1251	-
2000 (78.74)	1200 (47.24)	600 (23.62)	2	NSYSF2012602D	NSYSF2012602DP	-	NSY2SP206	NSYEC126	NSYEC1261	NSYEC1262
2000 (78.74)	1200 (47.24)	800 (31.50)	2	NSYSF2012802D	NSYSF2012802DP	-	NSY2SP208	NSYEC128	NSYEC1281	NSYEC1282
2000 (78.74)	1600 (62.99)	400 (15.75)	2	NSYSF2016402D	NSYSF2016402DP	-	NSY2SP204	NSYEC164	NSYEC1641	-
2000 (78.74)	1600 (62.99)	500 (19.68)	2	NSYSF2016502D	NSYSF2016502DP	-	NSY2SP205	NSYEC165	NSYEC1651	-
2000 (78.74)	1600 (62.99)	600 (23.62)	2	NSYSF2016602D	NSYSF2016602DP	-	NSY2SP206	NSYEC166	NSYEC1661	NSYEC1662
2200 (86.61)	400 (15.75)	600 (23.62)	1	NSYSF22460	-	-	NSY2SP226	-	NSYEC461	-
2200 (86.61)	600 (23.62)	600 (23.62)	1	NSYSF22660	NSYSF22660P	-	NSY2SP226	NSYEC66	NSYEC661	NSYEC662
2200 (86.61)	600 (23.62)	800 (31.50)	1	NSYSF22680	NSYSF22680P	-	NSY2SP228	NSYEC68	NSYEC681	NSYEC682
2200 (86.61)	800 (31.50)	600 (23.62)	1	NSYSF22860	NSYSF22860P	-	NSY2SP226	NSYEC86	NSYEC861	NSYEC862
2200 (86.61)	800 (31.50)	800 (31.50)	1	NSYSF22880	NSYSF22880P	NSYSF22880T	NSY2SP228	NSYEC88	NSYEC881	NSYEC882
2200 (86.61)	1000 (39.37)	600 (23.62)	1	NSYSF221060	NSYSF221060P	-	NSY2SP226	NSYEC106	NSYEC1061	NSYEC1062
2200 (86.61)	1200 (47.24)	600 (23.62)	2	NSYSF2212602D	NSYSF2212602DP	-	NSY2SP226	NSYEC126	NSYEC1261	NSYEC1262
2200 (86.61)	1200 (47.24)	800 (31.50)	2	NSYSF2212802D	NSYSF2212802DP	-	NSY2SP228	NSYEC128	NSYEC1281	NSYEC1282

Technical changes reserved. Information provided without guarantee. Images are for illustrative purposes only.

Plinth (H 100 (3.94) mm (in.))		Plinth (H 200 (7.87) mm (in.))		Mounting plates		Vertical uprights	
Front kit (corners + front panels)	Side panels, 2 u.	Front kit (corners + front panels)	Side panels, 4 u.	Mounting plate	Intermediate mounting plate	Standard	Technical
NSYSPF6100	NSYSPS4100	NSYSPF6200	NSYSPS4200	NSYMP126	NSYSIMP12	-	NSYTVR12
NSYSPF6100	NSYSPS6100	NSYSPF6200	NSYSPS6200	NSYMP126	NSYSIMP12	-	NSYTVR12
NSYSPF8100	NSYSPS4100	NSYSPF8200	NSYSPS4200	NSYMP128	NSYSIMP12	-	NSYTVR12
NSYSPF8100	NSYSPS6100	NSYSPF8200	NSYSPS6200	NSYMP128	NSYSIMP12	-	NSYTVR12
NSYSPF6100	NSYSPS4100	NSYSPF6200	NSYSPS4200	NSYMP146	NSYSIMP14	-	NSYTVR14
NSYSPF8100	NSYSPS4100	NSYSPF8200	NSYSPS4200	NSYMP148	NSYSIMP14	-	NSYTVR14
NSYSPF6100	NSYSPS6100	NSYSPF6200	NSYSPS6200	NSYMP166	NSYSIMP16	-	NSYTVR16
NSYSPF6100	NSYSPS8100	NSYSPF6200	NSYSPS8200	NSYMP166	NSYSIMP16	-	NSYTVR16
NSYSPF8100	NSYSPS6100	NSYSPF8200	NSYSPS6200	NSYMP168	NSYSIMP16	-	NSYTVR16
NSYSPF8100	NSYSPS8100	NSYSPF8200	NSYSPS8200	NSYMP168	NSYSIMP16	-	NSYTVR16
NSYSPF4100	NSYSPS4100	NSYSPF4200	NSYSPS4200	NSYMP184	NSYSIMP18	NSYVR18	NSYTVR18
NSYSPF4100	NSYSPS5100	NSYSPF4200	NSYSPS5200	NSYMP184	NSYSIMP18	NSYVR18	NSYTVR18
NSYSPF4100	NSYSPS6100	NSYSPF4200	NSYSPS6200	NSYMP184	NSYSIMP18	NSYVR18	NSYTVR18
NSYSPF6100	NSYSPS4100	NSYSPF6200	NSYSPS4200	NSYMP186	NSYSIMP18	NSYVR18	NSYTVR18
NSYSPF6100	NSYSPS5100	NSYSPF6200	NSYSPS5200	NSYMP186	NSYSIMP18	NSYVR18	NSYTVR18
NSYSPF6100	NSYSPS6100	NSYSPF6200	NSYSPS6200	NSYMP186	NSYSIMP18	NSYVR18	NSYTVR18
NSYSPF6100	NSYSPS8100	NSYSPF6200	NSYSPS8200	NSYMP186	NSYSIMP18	NSYVR18	NSYTVR18
NSYSPF8100	NSYSPS4100	NSYSPF8200	NSYSPS4200	NSYMP188	NSYSIMP18	NSYVR18	NSYTVR18
NSYSPF8100	NSYSPS5100	NSYSPF8200	NSYSPS5200	NSYMP188	NSYSIMP18	NSYVR18	NSYTVR18
NSYSPF8100	NSYSPS6100	NSYSPF8200	NSYSPS6200	NSYMP188	NSYSIMP18	NSYVR18	NSYTVR18
NSYSPF8100	NSYSPS8100	NSYSPF8200	NSYSPS8200	NSYMP188	NSYSIMP18	NSYVR18	NSYTVR18
NSYSPF10100	NSYSPS4100	NSYSPF10200	NSYSPS4200	NSYMP1810	NSYSIMP18	NSYVR18	NSYTVR18
NSYSPF10100	NSYSPS4100	NSYSPF10200	NSYSPS4200	NSYMP1810	NSYSIMP18	NSYVR18	NSYTVR18
NSYSPF10100	NSYSPS5100	NSYSPF10200	NSYSPS5200	NSYMP1810	NSYSIMP18	NSYVR18	NSYTVR18
NSYSPF10100	NSYSPS6100	NSYSPF10200	NSYSPS6200	NSYMP1810	NSYSIMP18	NSYVR18	NSYTVR18
NSYSPF10100	NSYSPS6100	NSYSPF10200	NSYSPS6200	NSYMP1810	NSYSIMP18	NSYVR18	NSYTVR18
NSYSPF12100	NSYSPS4100	NSYSPF12200	NSYSPS4200	NSYMP1812	NSYSIMP18	NSYVR18	NSYTVR18
NSYSPF12100	NSYSPS4100	NSYSPF12200	NSYSPS4200	NSYMP1812	NSYSIMP18	NSYVR18	NSYTVR18
NSYSPF12100	NSYSPS5100	NSYSPF12200	NSYSPS5200	NSYMP1812	NSYSIMP18	NSYVR18	NSYTVR18
NSYSPF12100	NSYSPS6100	NSYSPF12200	NSYSPS6200	NSYMP1812	NSYSIMP18	NSYVR18	NSYTVR18
NSYSPF3100	NSYSPS5100	NSYSPF3200	NSYSPS5200	-	-	NSYVR20	NSYTVR20
NSYSPF3100	NSYSPS6100	NSYSPF3200	NSYSPS6200	-	-	NSYVR20	NSYTVR20
NSYSPF3100	NSYSPS8100	NSYSPF3200	NSYSPS8200	-	-	NSYVR20	NSYTVR20
NSYSPF4100	NSYSPS4100	NSYSPF4200	NSYSPS4200	NSYMP204	NSYSIMP18	NSYVR20	NSYTVR20
NSYSPF4100	NSYSPS5100	NSYSPF4200	NSYSPS5200	NSYMP204	NSYSIMP18	NSYVR20	NSYTVR20
NSYSPF4100	NSYSPS6100	NSYSPF4200	NSYSPS6200	NSYMP204	NSYSIMP18	NSYVR20	NSYTVR20
NSYSPF4100	NSYSPS8100	NSYSPF4200	NSYSPS8200	NSYMP204	NSYSIMP18	NSYVR20	NSYTVR20
NSYSPF6100	NSYSPS4100	NSYSPF6200	NSYSPS4200	NSYMP206	NSYSIMP18	NSYVR20	NSYTVR20
NSYSPF6100	NSYSPS5100	NSYSPF6200	NSYSPS5200	NSYMP206	NSYSIMP20	NSYVR20	NSYTVR20
NSYSPF6100	NSYSPS6100	NSYSPF6200	NSYSPS6200	NSYMP206	NSYSIMP20	NSYVR20	NSYTVR20
NSYSPF6100	NSYSPS8100	NSYSPF6200	NSYSPS8200	NSYMP206	NSYSIMP20	NSYVR20	NSYTVR20
NSYSPF8100	NSYSPS4100	NSYSPF8200	NSYSPS4200	NSYMP208	NSYSIMP20	NSYVR20	NSYTVR20
NSYSPF8100	NSYSPS5100	NSYSPF8200	NSYSPS5200	NSYMP208	NSYSIMP20	NSYVR20	NSYTVR20
NSYSPF8100	NSYSPS6100	NSYSPF8200	NSYSPS6200	NSYMP208	NSYSIMP20	NSYVR20	NSYTVR20
NSYSPF8100	NSYSPS8100	NSYSPF8200	NSYSPS8200	NSYMP208	NSYSIMP20	NSYVR20	NSYTVR20
NSYSPF8100	NSYSPS8100	NSYSPF8200	NSYSPS8200	NSYMP208	NSYSIMP20	NSYVR20	NSYTVR20
NSYSPF10100	NSYSPS4100	NSYSPF10200	NSYSPS4200	NSYMP2010	NSYSIMP20	NSYVR20	NSYTVR20
NSYSPF10100	NSYSPS4100	NSYSPF10200	NSYSPS4200	NSYMP2010	NSYSIMP20	NSYVR20	NSYTVR20
NSYSPF10100	NSYSPS5100	NSYSPF10200	NSYSPS5200	NSYMP2010	NSYSIMP20	NSYVR20	NSYTVR20
NSYSPF10100	NSYSPS6100	NSYSPF10200	NSYSPS6200	NSYMP2010	NSYSIMP20	NSYVR20	NSYTVR20
NSYSPF10100	NSYSPS6100	NSYSPF10200	NSYSPS6200	NSYMP2010	NSYSIMP20	NSYVR20	NSYTVR20
NSYSPF10100	NSYSPS8100	NSYSPF10200	NSYSPS8200	NSYMP2010	NSYSIMP20	NSYVR20	NSYTVR20
NSYSPF12100	NSYSPS4100	NSYSPF12200	NSYSPS4200	NSYMP2012	NSYSIMP20	NSYVR20	NSYTVR20
NSYSPF12100	NSYSPS4100	NSYSPF12200	NSYSPS4200	NSYMP2012	NSYSIMP20	NSYVR20	NSYTVR20
NSYSPF12100	NSYSPS5100	NSYSPF12200	NSYSPS5200	NSYMP2012	NSYSIMP20	NSYVR20	NSYTVR20
NSYSPF12100	NSYSPS6100	NSYSPF12200	NSYSPS6200	NSYMP2012	NSYSIMP20	NSYVR20	NSYTVR20
NSYSPF12100	NSYSPS8100	NSYSPF12200	NSYSPS8200	NSYMP2012	NSYSIMP20	NSYVR20	NSYTVR20
NSYSPF16100	NSYSPS4100	NSYSPF16200	NSYSPS4200	NSYMP2016	NSYSIMP20	NSYVR20	NSYTVR20
NSYSPF16100	NSYSPS5100	NSYSPF16200	NSYSPS5200	NSYMP2016	NSYSIMP20	NSYVR20	NSYTVR20
NSYSPF16100	NSYSPS6100	NSYSPF16200	NSYSPS6200	NSYMP2016	NSYSIMP20	NSYVR20	NSYTVR20
NSYSPF4100	NSYSPS6100	NSYSPF4200	NSYSPS6200	NSYMP224	NSYSIMP22	NSYVR22	NSYTVR22
NSYSPF6100	NSYSPS6100	NSYSPF6200	NSYSPS6200	NSYMP226	NSYSIMP22	NSYVR22	NSYTVR22
NSYSPF6100	NSYSPS8100	NSYSPF6200	NSYSPS8200	NSYMP226	NSYSIMP22	NSYVR22	NSYTVR22
NSYSPF8100	NSYSPS6100	NSYSPF8200	NSYSPS6200	NSYMP228	NSYSIMP22	NSYVR22	NSYTVR22
NSYSPF8100	NSYSPS8100	NSYSPF8200	NSYSPS8200	NSYMP228	NSYSIMP22	NSYVR22	NSYTVR22
NSYSPF10100	NSYSPS6100	NSYSPF10200	NSYSPS6200	NSYMP2210	NSYSIMP22	NSYVR22	NSYTVR22
NSYSPF12100	NSYSPS6100	NSYSPF12200	NSYSPS6200	NSYMP2212	NSYSIMP22	NSYVR22	NSYTVR22
NSYSPF12100	NSYSPS8100	NSYSPF12200	NSYSPS8200	NSYMP2212	NSYSIMP22	NSYVR22	NSYTVR22

Technical changes reserved. Information provided without guarantee. Images are for illustrative purposes only.

Dimensions			Doors	Vertical uprights	Bottom frame and top frame with roof	Panels		Doors		Mounting plate
(A) Height mm (in.)	(B) Width mm (in.)	(C) Depth mm (in.)				Rear panel	Side panel	Plain	Transparent	
1200 (47.24)	600 (23.62)	400 (15.75)	1	NSYSFV12	NSYSFC64	NSYBP126	NSY2SP124	NSYSFD126	NSYSFD126T	NSYMP126
1200 (47.24)	600 (23.62)	500 (19.68)	1	NSYSFV12	NSYSFC65	NSYBP126	NSY2SP125	NSYSFD126	NSYSFD126T	NSYMP126
1200 (47.24)	600 (23.62)	600 (23.62)	1	NSYSFV12	NSYSFC66	NSYBP126	NSY2SP126	NSYSFD126	NSYSFD126T	NSYMP126
1200 (47.24)	600 (23.62)	800 (31.50)	1	NSYSFV12	NSYSFC68	NSYBP126	NSY2SP128	NSYSFD126	NSYSFD126T	NSYMP126
1200 (47.24)	800 (31.50)	400 (15.75)	1	NSYSFV12	NSYSFC84	NSYBP128	NSY2SP124	NSYSFD128	NSYSFD128T	NSYMP128
1200 (47.24)	800 (31.50)	500 (19.68)	1	NSYSFV12	NSYSFC85	NSYBP128	NSY2SP125	NSYSFD128	NSYSFD128T	NSYMP128
1200 (47.24)	800 (31.50)	600 (23.62)	1	NSYSFV12	NSYSFC86	NSYBP128	NSY2SP126	NSYSFD128	NSYSFD128T	NSYMP128
1200 (47.24)	800 (31.50)	800 (31.50)	1	NSYSFV12	NSYSFC88	NSYBP128	NSY2SP128	NSYSFD128	NSYSFD128T	NSYMP128
1400 (55.12)	600 (23.62)	400 (15.75)	1	NSYSFV14	NSYSFC64	NSYBP146	NSY2SP144	NSYSFD146	NSYSFD146T	NSYMP146
1400 (55.12)	600 (23.62)	500 (19.68)	1	NSYSFV14	NSYSFC65	NSYBP146	NSY2SP145	NSYSFD146	NSYSFD146T	NSYMP146
1400 (55.12)	600 (23.62)	600 (23.62)	1	NSYSFV14	NSYSFC66	NSYBP146	NSY2SP146	NSYSFD146	NSYSFD146T	NSYMP146
1400 (55.12)	600 (23.62)	800 (31.50)	1	NSYSFV14	NSYSFC68	NSYBP146	NSY2SP148	NSYSFD146	NSYSFD146T	NSYMP146
1400 (55.12)	800 (31.50)	400 (15.75)	1	NSYSFV14	NSYSFC84	NSYBP148	NSY2SP144	NSYSFD148	NSYSFD148T	NSYMP148
1400 (55.12)	800 (31.50)	500 (19.68)	1	NSYSFV14	NSYSFC85	NSYBP148	NSY2SP145	NSYSFD148	NSYSFD148T	NSYMP148
1400 (55.12)	800 (31.50)	600 (23.62)	1	NSYSFV14	NSYSFC86	NSYBP148	NSY2SP146	NSYSFD148	NSYSFD148T	NSYMP148
1400 (55.12)	800 (31.50)	800 (31.50)	1	NSYSFV14	NSYSFC88	NSYBP148	NSY2SP148	NSYSFD148	NSYSFD148T	NSYMP148
1600 (62.99)	600 (23.62)	400 (15.75)	1	NSYSFV16	NSYSFC64	NSYBP166	NSY2SP164	NSYSFD166	NSYSFD166T	NSYMP166
1600 (62.99)	600 (23.62)	500 (19.68)	1	NSYSFV16	NSYSFC65	NSYBP166	NSY2SP165	NSYSFD166	NSYSFD166T	NSYMP166
1600 (62.99)	600 (23.62)	600 (23.62)	1	NSYSFV16	NSYSFC66	NSYBP166	NSY2SP166	NSYSFD166	NSYSFD166T	NSYMP166
1600 (62.99)	600 (23.62)	800 (31.50)	1	NSYSFV16	NSYSFC68	NSYBP166	NSY2SP168	NSYSFD166	NSYSFD166T	NSYMP166
1600 (62.99)	800 (31.50)	400 (15.75)	1	NSYSFV16	NSYSFC84	NSYBP168	NSY2SP164	NSYSFD168	NSYSFD168T	NSYMP168
1600 (62.99)	800 (31.50)	500 (19.68)	1	NSYSFV16	NSYSFC85	NSYBP168	NSY2SP165	NSYSFD168	NSYSFD168T	NSYMP168
1600 (62.99)	800 (31.50)	600 (23.62)	1	NSYSFV16	NSYSFC86	NSYBP168	NSY2SP166	NSYSFD168	NSYSFD168T	NSYMP168
1600 (62.99)	800 (31.50)	800 (31.50)	1	NSYSFV16	NSYSFC88	NSYBP168	NSY2SP168	NSYSFD168	NSYSFD168T	NSYMP168
1800 (70.87)	400 (15.75)	400 (15.75)	1	NSYSFV18	NSYSFC44	NSYBP184	NSY2SP184	NSYSFD184	-	NSYMP184
1800 (70.87)	400 (15.75)	500 (19.68)	1	NSYSFV18	NSYSFC45	NSYBP184	NSY2SP185	NSYSFD184	-	NSYMP184
1800 (70.87)	400 (15.75)	600 (23.62)	1	NSYSFV18	NSYSFC46	NSYBP184	NSY2SP186	NSYSFD184	-	NSYMP184
1800 (70.87)	400 (15.75)	800 (31.50)	1	NSYSFV18	NSYSFC48	NSYBP184	NSY2SP188	NSYSFD184	-	NSYMP184
1800 (70.87)	600 (23.62)	400 (15.75)	1	NSYSFV18	NSYSFC64	NSYBP186	NSY2SP184	NSYSFD186	NSYSFD186T	NSYMP186
1800 (70.87)	600 (23.62)	500 (19.68)	1	NSYSFV18	NSYSFC65	NSYBP186	NSY2SP185	NSYSFD186	NSYSFD186T	NSYMP186
1800 (70.87)	600 (23.62)	600 (23.62)	1	NSYSFV18	NSYSFC66	NSYBP186	NSY2SP186	NSYSFD186	NSYSFD186T	NSYMP186
1800 (70.87)	600 (23.62)	800 (31.50)	1	NSYSFV18	NSYSFC68	NSYBP186	NSY2SP188	NSYSFD186	NSYSFD186T	NSYMP186
1800 (70.87)	800 (31.50)	400 (15.75)	1	NSYSFV18	NSYSFC84	NSYBP188	NSY2SP184	NSYSFD188	NSYSFD188T	NSYMP188
1800 (70.87)	800 (31.50)	500 (19.68)	1	NSYSFV18	NSYSFC85	NSYBP188	NSY2SP185	NSYSFD188	NSYSFD188T	NSYMP188
1800 (70.87)	800 (31.50)	600 (23.62)	1	NSYSFV18	NSYSFC86	NSYBP188	NSY2SP186	NSYSFD188	NSYSFD188T	NSYMP188
1800 (70.87)	800 (31.50)	800 (31.50)	2	NSYSFV18	NSYSFC86	NSYBP188	NSY2SP186	NSYSFD1882D	-	NSYMP188
1800 (70.87)	800 (31.50)	800 (31.50)	1	NSYSFV18	NSYSFC88	NSYBP188	NSY2SP188	NSYSFD188	NSYSFD188T	NSYMP188
1800 (70.87)	800 (31.50)	800 (31.50)	2	NSYSFV18	NSYSFC88	NSYBP188	NSY2SP188	NSYSFD1882D	-	NSYMP188
1800 (70.87)	1000 (39.37)	400 (15.75)	1	NSYSFV18	NSYSFC104	NSYBP1810	NSY2SP184	NSYSFD1810	NSYSFD1810T	NSYMP1810
1800 (70.87)	1000 (39.37)	400 (15.75)	2	NSYSFV18	NSYSFC104	NSYBP1810	NSY2SP184	NSYSFD18102D	-	NSYMP1810
1800 (70.87)	1000 (39.37)	500 (19.68)	1	NSYSFV18	NSYSFC105	NSYBP1810	NSY2SP185	NSYSFD1810	NSYSFD1810T	NSYMP1810
1800 (70.87)	1000 (39.37)	600 (23.62)	1	NSYSFV18	NSYSFC106	NSYBP1810	NSY2SP186	NSYSFD1810	NSYSFD1810T	NSYMP1810
1800 (70.87)	1000 (39.37)	600 (23.62)	2	NSYSFV18	NSYSFC106	NSYBP1810	NSY2SP186	NSYSFD18102D	-	NSYMP1810
1800 (70.87)	1000 (39.37)	800 (31.50)	1	NSYSFV18	NSYSFC108	NSYBP1810	NSY2SP188	NSYSFD1810	NSYSFD1810T	NSYMP1810
1800 (70.87)	1000 (39.37)	800 (31.50)	2	NSYSFV18	NSYSFC108	NSYBP1810	NSY2SP188	NSYSFD18102D	-	NSYMP1810
1800 (70.87)	1200 (47.24)	400 (15.75)	2	NSYSFV18	NSYSFC124	NSYBP1812	NSY2SP184	NSYSFD18122D	NSYSFD18122DT	NSYMP1812
1800 (70.87)	1200 (47.24)	500 (19.68)	2	NSYSFV18	NSYSFC125	NSYBP1812	NSY2SP185	NSYSFD18122D	NSYSFD18122DT	NSYMP1812
1800 (70.87)	1200 (47.24)	600 (23.62)	2	NSYSFV18	NSYSFC126	NSYBP1812	NSY2SP186	NSYSFD18122D	NSYSFD18122DT	NSYMP1812
1800 (70.87)	1200 (47.24)	800 (31.50)	2	NSYSFV18	NSYSFC128	NSYBP1812	NSY2SP188	NSYSFD18122D	NSYSFD18122DT	NSYMP1812

Dimensions			Doors	Vertical uprights	Bottom frame and top frame with roof	Panels		Doors		Mounting plate
(A) Height mm (in.)	(B) Width mm (in.)	(C) Depth mm (in.)				Rear panel	Side panel	Plain	Transparent	
2000 (78.74)	300 (11.81)	500 (19.68)	1	NSYSFV20	NSYSFC35	NSYBP203	NSY2SP205	NSYSFD203	-	-
2000 (78.74)	300 (11.81)	600 (23.62)	1	NSYSFV20	NSYSFC36	NSYBP203	NSY2SP206	NSYSFD203	-	-
2000 (78.74)	300 (11.81)	800 (31.50)	1	NSYSFV20	NSYSFC38	NSYBP203	NSY2SP208	NSYSFD203	-	-
2000 (78.74)	400 (15.75)	400 (15.75)	1	NSYSFV20	NSYSFC44	NSYBP204	NSY2SP204	NSYSFD204	-	NSYMP204
2000 (78.74)	400 (15.75)	500 (19.68)	1	NSYSFV20	NSYSFC45	NSYBP204	NSY2SP205	NSYSFD204	-	NSYMP204
2000 (78.74)	400 (15.75)	600 (23.62)	1	NSYSFV20	NSYSFC46	NSYBP204	NSY2SP206	NSYSFD204	-	NSYMP204
2000 (78.74)	400 (15.75)	800 (31.50)	1	NSYSFV20	NSYSFC48	NSYBP204	NSY2SP208	NSYSFD204	-	NSYMP204
2000 (78.74)	600 (23.62)	400 (15.75)	1	NSYSFV20	NSYSFC64	NSYBP206	NSY2SP204	NSYSFD206	NSYSFD206T	NSYMP206
2000 (78.74)	600 (23.62)	500 (19.68)	1	NSYSFV20	NSYSFC65	NSYBP206	NSY2SP205	NSYSFD206	NSYSFD206T	NSYMP206
2000 (78.74)	600 (23.62)	600 (23.62)	1	NSYSFV20	NSYSFC66	NSYBP206	NSY2SP206	NSYSFD206	NSYSFD206T	NSYMP206
2000 (78.74)	600 (23.62)	800 (31.50)	1	NSYSFV20	NSYSFC68	NSYBP206	NSY2SP208	NSYSFD206	NSYSFD206T	NSYMP206
2000 (78.74)	800 (31.50)	400 (15.75)	1	NSYSFV20	NSYSFC84	NSYBP208	NSY2SP204	NSYSFD208	NSYSFD208T	NSYMP208
2000 (78.74)	800 (31.50)	500 (19.68)	1	NSYSFV20	NSYSFC85	NSYBP208	NSY2SP205	NSYSFD208	NSYSFD208T	NSYMP208
2000 (78.74)	800 (31.50)	600 (23.62)	1	NSYSFV20	NSYSFC86	NSYBP208	NSY2SP206	NSYSFD208	NSYSFD208T	NSYMP208
2000 (78.74)	800 (31.50)	600 (23.62)	2	NSYSFV20	NSYSFC86	NSYBP208	NSY2SP206	NSYSFD2082D	-	NSYMP208
2000 (78.74)	800 (31.50)	800 (31.50)	1	NSYSFV20	NSYSFC88	NSYBP208	NSY2SP208	NSYSFD208	NSYSFD208T	NSYMP208
2000 (78.74)	800 (31.50)	800 (31.50)	2	NSYSFV20	NSYSFC88	NSYBP208	NSY2SP208	NSYSFD2082D	-	NSYMP208
2000 (78.74)	1000 (39.37)	400 (15.75)	1	NSYSFV20	NSYSFC104	NSYBP2010	NSY2SP204	NSYSFD2010	NSYSFD2010T	NSYMP2010
2000 (78.74)	1000 (39.37)	400 (15.75)	2	NSYSFV20	NSYSFC104	NSYBP2010	NSY2SP204	NSYSFD20102D	-	NSYMP2010
2000 (78.74)	1000 (39.37)	500 (19.68)	1	NSYSFV20	NSYSFC105	NSYBP2010	NSY2SP205	NSYSFD2010	NSYSFD2010T	NSYMP2010
2000 (78.74)	1000 (39.37)	500 (19.68)	2	NSYSFV20	NSYSFC105	NSYBP2010	NSY2SP205	NSYSFD20102D	-	NSYMP2010
2000 (78.74)	1000 (39.37)	600 (23.62)	1	NSYSFV20	NSYSFC106	NSYBP2010	NSY2SP206	NSYSFD2010	NSYSFD2010T	NSYMP2010
2000 (78.74)	1000 (39.37)	600 (23.62)	2	NSYSFV20	NSYSFC106	NSYBP2010	NSY2SP206	NSYSFD20102D	-	NSYMP2010
2000 (78.74)	1000 (39.37)	800 (31.50)	1	NSYSFV20	NSYSFC108	NSYBP2010	NSY2SP208	NSYSFD2010	NSYSFD2010T	NSYMP2010
2000 (78.74)	1000 (39.37)	800 (31.50)	2	NSYSFV20	NSYSFC108	NSYBP2010	NSY2SP208	NSYSFD20102D	-	NSYMP2010
2000 (78.74)	1200 (47.24)	400 (15.75)	2	NSYSFV20	NSYSFC124	NSYBP2012	NSY2SP204	NSYSFD20122D	NSYSFD20122DT	NSYMP2012
2000 (78.74)	1200 (47.24)	500 (19.68)	2	NSYSFV20	NSYSFC125	NSYBP2012	NSY2SP205	NSYSFD20122D	NSYSFD20122DT	NSYMP2012
2000 (78.74)	1200 (47.24)	600 (23.62)	2	NSYSFV20	NSYSFC126	NSYBP2012	NSY2SP206	NSYSFD20122D	NSYSFD20122DT	NSYMP2012
2000 (78.74)	1200 (47.24)	800 (31.50)	2	NSYSFV20	NSYSFC128	NSYBP2012	NSY2SP208	NSYSFD20122D	NSYSFD20122DT	NSYMP2012
2000 (78.74)	1600 (62.99)	400 (15.75)	2	NSYSFV20	NSYSFC164	NSYBP2016	NSY2SP204	NSYSFD20162D	-	NSYMP2016
2000 (78.74)	1600 (62.99)	500 (19.68)	2	NSYSFV20	NSYSFC165	NSYBP2016	NSY2SP205	NSYSFD20162D	-	NSYMP2016
2000 (78.74)	1600 (62.99)	600 (23.62)	2	NSYSFV20	NSYSFC166	NSYBP2016	NSY2SP206	NSYSFD20162D	-	NSYMP2016
2200 (86.61)	400 (15.75)	400 (15.75)	1	NSYSFV22	NSYSFC44	NSYBP224	NSY2SP224	NSYSFD224	-	NSYMP224
2200 (86.61)	400 (15.75)	500 (19.68)	1	NSYSFV22	NSYSFC45	NSYBP224	NSY2SP225	NSYSFD224	-	NSYMP224
2200 (86.61)	400 (15.75)	600 (23.62)	1	NSYSFV22	NSYSFC46	NSYBP224	NSY2SP226	NSYSFD224	-	NSYMP224
2200 (86.61)	400 (15.75)	800 (31.50)	1	NSYSFV22	NSYSFC48	NSYBP224	NSY2SP228	NSYSFD224	-	NSYMP224
2200 (86.61)	600 (23.62)	400 (15.75)	1	NSYSFV22	NSYSFC64	NSYBP226	NSY2SP224	NSYSFD226	NSYSFD226T	NSYMP226
2200 (86.61)	600 (23.62)	500 (19.68)	1	NSYSFV22	NSYSFC65	NSYBP226	NSY2SP225	NSYSFD226	NSYSFD226T	NSYMP226
2200 (86.61)	600 (23.62)	600 (23.62)	1	NSYSFV22	NSYSFC66	NSYBP226	NSY2SP226	NSYSFD226	NSYSFD226T	NSYMP226
2200 (86.61)	600 (23.62)	800 (31.50)	1	NSYSFV22	NSYSFC68	NSYBP226	NSY2SP228	NSYSFD226	NSYSFD226T	NSYMP226
2200 (86.61)	800 (31.50)	400 (15.75)	1	NSYSFV22	NSYSFC84	NSYBP228	NSY2SP224	NSYSFD228	NSYSFD228T	NSYMP228
2200 (86.61)	800 (31.50)	500 (19.68)	1	NSYSFV22	NSYSFC85	NSYBP228	NSY2SP225	NSYSFD228	NSYSFD228T	NSYMP228
2200 (86.61)	800 (31.50)	600 (23.62)	1	NSYSFV22	NSYSFC86	NSYBP228	NSY2SP226	NSYSFD228	NSYSFD228T	NSYMP228
2200 (86.61)	800 (31.50)	800 (31.50)	1	NSYSFV22	NSYSFC88	NSYBP228	NSY2SP228	NSYSFD228	NSYSFD228T	NSYMP228
2200 (86.61)	1000 (39.37)	400 (15.75)	1	NSYSFV22	NSYSFC104	NSYBP2210	NSY2SP224	NSYSFD2210	NSYSFD2210T	NSYMP2210
2200 (86.61)	1000 (39.37)	500 (19.68)	1	NSYSFV22	NSYSFC105	NSYBP2210	NSY2SP225	NSYSFD2210	NSYSFD2210T	NSYMP2210
2200 (86.61)	1000 (39.37)	600 (23.62)	1	NSYSFV22	NSYSFC106	NSYBP2210	NSY2SP226	NSYSFD2210	NSYSFD2210T	NSYMP2210
2200 (86.61)	1000 (39.37)	800 (31.50)	1	NSYSFV22	NSYSFC108	NSYBP2210	NSY2SP228	NSYSFD2210	NSYSFD2210T	NSYMP2210
2200 (86.61)	1200 (47.24)	400 (15.75)	2	NSYSFV22	NSYSFC124	NSYBP2212	NSY2SP224	NSYSFD22122D	NSYSFD22122DT	NSYMP2212
2200 (86.61)	1200 (47.24)	500 (19.68)	2	NSYSFV22	NSYSFC125	NSYBP2212	NSY2SP225	NSYSFD22122D	NSYSFD22122DT	NSYMP2212
2200 (86.61)	1200 (47.24)	600 (23.62)	2	NSYSFV22	NSYSFC126	NSYBP2212	NSY2SP226	NSYSFD22122D	NSYSFD22122DT	NSYMP2212
2200 (86.61)	1200 (47.24)	800 (31.50)	2	NSYSFV22	NSYSFC128	NSYBP2212	NSY2SP228	NSYSFD22122D	NSYSFD22122DT	NSYMP2212

Technical changes reserved. Information provided without guarantee. Images are for illustrative purposes only.

External dimensions					304L stainless-steel	316L stainless-steel	304L stainless-steel	
Height mm (in.)	Width mm (in.)	Depth mm (in.)	No. of locks	No. of doors	Plain door	Glazed door. The glazed door has no reinforcement.	Plain door	Canopy
300 (11.81)	200 (7.87)	150 (5.91)	1	1	NSYS3X3215	-	NSYS3X3215H	NSYTX2015
300 (11.81)	250 (9.84)	150 (5.91)	1	1	NSYS3X302515	-	NSYS3X302515H	NSYTX2515
300 (11.81)	300 (11.81)	150 (5.91)	1	1	NSYS3X3315	-	NSYS3X3315H	NSYTX3015
400 (15.75)	300 (11.81)	150 (5.91)	1	1	NSYS3X4315	-	NSYS3X4315H	NSYTX3015
400 (15.75)	300 (11.81)	200 (7.87)	1	1	NSYS3X4320	NSYS3X4320T	NSYS3X4320H	NSYTX3020
400 (15.75)	400 (15.75)	200 (7.87)	1	1	NSYS3X4420	-	NSYS3X4420H	NSYTX4020
400 (15.75)	600 (23.62)	200 (7.87)	1	1	NSYS3X4620	-	NSYS3X4620H	NSYTX6020
500 (19.68)	400 (15.75)	200 (7.87)	2	1	NSYS3X5420	NSYS3X5420T	NSYS3X5420H	NSYTX4020
600 (23.62)	400 (15.75)	200 (7.87)	2	1	NSYS3X6420	NSYS3X6420T	NSYS3X6420H	NSYTX4020
600 (23.62)	600 (23.62)	250 (9.84)	2	1	NSYS3X6625	-	NSYS3X6625H	NSYTX6025
600 (23.62)	1000 (39.37)	300 (11.81)	-	2	NSYS3X601030	-	-	-
600 (23.62)	1200 (47.24)	300 (11.81)	-	2	NSYS3X601230	-	-	NSYTX12030
700 (27.56)	500 (19.68)	250 (9.84)	2	1	NSYS3X7525	NSYS3X7525T	NSYS3X7525H	NSYTX5025
800 (31.50)	600 (23.62)	250 (9.84)	2	1	NSYS3X8625	NSYS3X8625T	NSYS3X8625H	NSYTX6025
800 (31.50)	800 (31.50)	300 (11.81)	2	1	NSYS3X8830	-	NSYS3X8830H	NSYTX8030
800 (31.50)	1000 (39.37)	300 (11.81)	-	2	NSYS3X801030	-	-	-
800 (31.50)	1200 (47.24)	300 (11.81)	-	2	NSYS3X801230	-	-	NSYTX12030
1000 (39.37)	800 (31.50)	300 (11.81)	2	1	NSYS3X10830	NSYS3X10830T	NSYS3X10830H	NSYTX8030
1000 (39.37)	1000 (39.37)	300 (11.81)	-	2	NSYS3X101030	-	NSYS3X101030H	NSYTX10030
1200 (47.24)	800 (31.50)	300 (11.81)	2	1	NSYS3X12830	-	NSYS3X12830H	NSYTX8030
1200 (47.24)	1000 (39.37)	300 (11.81)	-	2	NSYS3X121030	-	NSYS3X121030H	NSYTX10030

⁽¹⁾ Three-point locking system.

Accessories

External dimensions									
Height mm (in.)	Width mm (in.)	Depth mm (in.)	No. of modules		Mounting plate Plain	Mounting plate Silkscreened	Mounting plate Micro-perforated	Mounting plate Tele-quick	Step slides
300 (11.81)	200 (7.87)	150 (5.91)	-		NSYMM32	-	NSYMF32	NSYMR32	-
300 (11.81)	250 (9.84)	150 (5.91)	-		NSYMM3025	-	-	NSYMR3025	-
300 (11.81)	300 (11.81)	150 (5.91)	-		NSYMM33	-	NSYMF33	NSYMR33	-
400 (15.75)	300 (11.81)	150 (5.91)	24		NSYMM43	NSYMS43	NSYMF43	NSYMR43	-
400 (15.75)	300 (11.81)	200 (7.87)	24		NSYMM43	NSYMS43	NSYMF43	NSYMR43	NSYSDCR200
400 (15.75)	400 (15.75)	200 (7.87)	-		NSYMM44	NSYMS44	NSYMF44	NSYMR44	NSYSDCR200
400 (15.75)	600 (23.62)	200 (7.87)	-		NSYMM64	NSYMS64	NSYMF64	NSYMR46	NSYSDCR200
500 (19.68)	400 (15.75)	200 (7.87)	48		NSYMM54	NSYMS54	NSYMF54	NSYMR54	NSYSDCR200
600 (23.62)	400 (15.75)	200 (7.87)	48		NSYMM64	NSYMS64	NSYMF64	NSYMR64	NSYSDCR200
600 (23.62)	600 (23.62)	250 (9.84)	84		NSYMM66	NSYMS66	NSYMF66	NSYMR66	NSYSDCR250
600 (23.62)	1000 (39.37)	300 (11.81)	-		NSYMM106	-	NSYMF106	NSYMR106	NSYSDCR300
600 (23.62)	1200 (47.24)	300 (11.81)	-		NSYMM126	-	NSYMF126	-	NSYSDCR300
700 (27.56)	500 (19.68)	250 (9.84)	66		NSYMM75	NSYMS75	NSYMF75	NSYMR75	NSYSDCR250
700 (27.56)	500 (19.68)	250 (9.84)	88		-	-	-	-	-
800 (31.50)	600 (23.62)	250 (9.84)	84		NSYMM86	NSYMS86	NSYMF86	NSYMR86	NSYSDCR250
800 (31.50)	600 (23.62)	250 (9.84)	112		-	-	-	-	-
800 (31.50)	800 (31.50)	300 (11.81)	-		NSYMM88	-	NSYMF88	NSYMR88	NSYSDCR300
800 (31.50)	1000 (39.37)	300 (11.81)	-		NSYMM108	-	NSYMF108	NSYMR108	NSYSDCR300
800 (31.50)	1200 (47.24)	300 (11.81)	-		NSYMM128	-	NSYMF128	NSYMR128	NSYSDCR300
1000 (39.37)	800 (31.50)	300 (11.81)	234		NSYMM108	-	NSYMF108	NSYMR108	NSYSDCR300
1000 (39.37)	1000 (39.37)	300 (11.81)	-		NSYMM1010	-	NSYMF1010	NSYMR1010	NSYSDCR300
1200 (47.24)	800 (31.50)	300 (11.81)	-		NSYMM128	-	NSYMF128	NSYMR128	NSYSDCR300
1200 (47.24)	1000 (39.37)	300 (11.81)	-		NSYMM1210	-	NSYMF1210	NSYMR1210	NSYSDCR300

⁽¹⁾ Three-point locking system.

Technical changes reserved. Information provided without guarantee. Images are for illustrative purposes only.

Stainless-steel floor-standing enclosures

External dimensions			No. of front doors	304L stainless-steel	316L stainless-steel	Brushed 304L / 316L stainless-steel plinth height 100 (39.37) mm (in.)*	Brushed 304L / 316L stainless-steel plinth height 200 (78.74) mm (in.)*	Mounting plate**		
Height mm (in.)	Width mm (in.)	Depth mm (in.)		Floor-standing enclosure	Floor-standing enclosure	Kit (4 corners + front and back)	Set of 2 side panels	Kit (4 corners + front and back)	Set of 2 side panels (x2)	Plain
1400 (55.12)	1000 (39.37)	300 (11.81)	2	NSYSMX141030	-	NSYSFPX10100	NSYSPSX3100	NSYSFPX10200	NSYSPSX3200	NSYMP1410
1600 (62.99)	800 (31.50)	400 (15.75)	1	NSYSMX16840	-	NSYSFPX8100	NSYSPSX4100	NSYSFPX8200	NSYSPSX4200	NSYMP168
1800 (70.87)	600 (23.62)	400 (15.75)	1	NSYSMX18640	-	NSYSFPX6100	NSYSPSX4100	NSYSFPX6200	NSYSPSX4200	NSYMP186
1800 (70.87)	800 (31.50)	400 (15.75)	1	NSYSMX18840	NSYSMX18840H	NSYSFPX8100	NSYSPSX4100	NSYSFPX8200	NSYSPSX4200	NSYMP188
1800 (70.87)	1200 (47.24)	400 (15.75)	2	NSYSMX181240	NSYSMX181240H	NSYSFPX12100	NSYSPSX4100	NSYSFPX12200	NSYSPSX4200	NSYMP1812
1800 (70.87)	1600 (62.99)	400 (15.75)	2	NSYSMX181640	NSYSMX181640H	NSYSFPX16100	NSYSPSX4100	NSYSFPX16200	NSYSPSX4200	NSYMP1816
2000 (78.74)	800 (31.50)	500 (19.68)	1	NSYSMX20850	-	NSYSFPX8100	NSYSPSX5100	NSYSFPX8200	NSYSPSX5200	NSYMP208
2000 (78.74)	1000 (39.37)	400 (15.75)	2	NSYSMX201040	NSYSMX201040H	NSYSFPX10100	NSYSPSX4100	NSYSFPX10200	NSYSPSX4200	NSYMP2010
2000 (78.74)	1200 (47.24)	500 (19.68)	2	NSYSMX201250	NSYSMX201250H	NSYSFPX12100	NSYSPSX5100	NSYSFPX12200	NSYSPSX5200	NSYMP2012
2000 (78.74)	1600 (62.99)	600 (23.62)	2	NSYSMX201660	NSYSMX201660H	NSYSFPX16100	NSYSPSX6100	NSYSFPX16200	NSYSPSX6200	NSYMP2016

Stainless-steel floor-standing enclosures

External dimensions			No. of front doors	304L stainless-steel (316L stainless-steel enclosures on request)	Brushed 304L stainless-steel plinth height 100 (39.37) mm (in.)*	Brushed 304L stainless-steel plinth height 200 (78.74) mm (in.)*	Mounting plate**				
Height mm (in.)	Width mm (in.)	Depth mm (in.)		Suitable enclosure	Set of 2 side panels	Coupling kit	Kit (4 corners + front and back)	Set of 2 side panels	Kit (4 corners + front and back)	Side Set of 2 side panels (x2)	Plain
1800 (70.87)	600 (23.62)	400 (15.75)	1	NSYSFX18640	NSY2SPX184	NSYSFBK19	NSYSFPX6100	NSYSPSX4100SF	NSYSFPX6200	NSYSPSX4200SF	NSYMP186
1800 (70.87)	800 (31.50)	400 (15.75)	1	NSYSFX18840	NSY2SPX184	+	NSYSFPX8100	NSYSPSX4100SF	NSYSFPX8200	NSYSPSX4200SF	NSYMP188
1800 (70.87)	1200 (47.24)	400 (15.75)	2	NSYSFX181240	NSY2SPX184	NSYSFXJG	NSYSFPX12100	NSYSPSX4100SF	NSYSFPX12200	NSYSPSX4200SF	NSYMP1812
2000 (78.74)	600 (23.62)	500 (19.68)	1	NSYSFX20650	NSY2SPX205		NSYSFPX6100	NSYSPSX5100SF	NSYSFPX6200	NSYSPSX5200SF	NSYMP206
2000 (78.74)	800 (31.50)	400 (15.75)	1	NSYSFX20840	NSY2SPX204		NSYSFPX8100	NSYSPSX4100SF	NSYSFPX8200	NSYSPSX4200SF	NSYMP208
2000 (78.74)	800 (31.50)	600 (23.62)	1	NSYSFX20860	NSY2SPX206		NSYSFPX8100	NSYSPSX6100SF	NSYSFPX8200	NSYSPSX6200SF	NSYMP208
2000 (78.74)	1000 (39.37)	600 (23.62)	2	NSYSFX201060	NSY2SPX206		NSYSFPX10100	NSYSPSX6100SF	NSYSFPX10200	NSYSPSX6200SF	NSYMP2010
2000 (78.74)	1200 (47.24)	600 (23.62)	2	NSYSFX201260	NSY2SPX206		NSYSFPX12100	NSYSPSX6100SF	NSYSFPX12200	NSYSPSX6200SF	NSYMP2012

Stainless-steel floor-standing suitable

External dimensions			No. of front doors	Stainless-steel	304L stainless-steel plinth, height 100 (39.37) mm (in.)*	304L stainless-steel plinth, height 200 (78.74) mm (in.)*	Mounting plate**		
Height mm (in.)	Width mm (in.)	Depth mm (in.)		Floor-standing suitable	Front and rear	side panels	Front and rear	side panels	Plain
1000 (39.37)	600 (23.62)	500 (19.68)	1	NSYSDX6	NSYSFPX6100	NSYSPSX5100	NSYSFPX6200	2x NSYSPSX5100	NSYPMP8560
1000 (39.37)	800 (31.50)	500 (19.68)	1	NSYSDX8	NSYSFPX8100	NSYSPSX5100	NSYSFPX8200	2x NSYSPSX5100	NSYPMP8580
1000 (39.37)	1000 (39.37)	500 (19.68)	2	NSYSDX10	NSYSFPX10100	NSYSPSX5100	NSYSFPX10200	2x NSYSPSX5100	NSYPMP85100
1000 (39.37)	1200 (47.24)	500 (19.68)	2	NSYSDX12	NSYSFPX12100	NSYSPSX5100	NSYSFPX12200	2x NSYSPSX5100	NSYPMP85120

* See section on stainless-steel composition accessories.

** See other mounting plates in common accessories.

Polyester Wall-Mounted Enclosures

Polyester wall-mounted enclosures IP66



Class II



External dimensions			References of wall-mounted enclosures with door							
Height mm (in.)	Width mm (in.)	Depth mm (in.)	Plain	Transparent	Plain	Transparent	Plain	Transparent	Plain	Transparent
308 (12.13)	255 (10.04)	160 (6.30)	-	-	NSYPLM3025G	NSYPLM3025TG	-	-	-	-
310 (12.20)	215 (8.46)	160 (6.30)	NSYPLM32G	NSYPLM32TG	-	-	-	-	-	-
430 (16.93)	330 (12.99)	200 (7.87)	-	-	-	-	NSYPLM43G	NSYPLM43TG	NSYPLM43VG	NSYPLM43TVG
530 (20.87)	430 (16.93)	200 (7.87)	-	-	-	-	NSYPLM54G	NSYPLM54TG	NSYPLM54VG	NSYPLM54TVG
647 (25.47)	436 (17.16)	250 (9.84)	-	-	-	-	NSYPLM64G	NSYPLM64TG	NSYPLM64VG	NSYPLM64TVG
747 (29.41)	536 (21.10)	300 (11.81)	-	-	-	-	NSYPLM75G	NSYPLM75TG	NSYPLM75VG	NSYPLM75TVG
847 (33.35)	636 (25.04)	300 (11.81)	-	-	-	-	NSYPLM86G	NSYPLM86TG	NSYPLM86VG	NSYPLM86TVG
1056 (41.58)	852 (33.54)	350 (13.78)	-	-	-	-	NSYPLM108G	NSYPLM108TG	-	-
Details			see page 199							

New

PLM landscape (horizontal) range for photovoltaic and multiple applications with removable door system [see page 338](#)

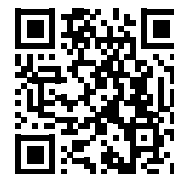

Scan or click for video

Polyester Wall-Mounted Enclosures

Mounting accessories

Dimensions			Metal mounting plates				Insulated mounting plates		Step slides	Symmetrical DIN rail
Height mm (in.)	Width mm (in.)	Depth mm (in.)	Plain	Silkscreened	Micro-perforated	Telequick	Bakelite	Polyester		
310 (12.20)	215 (8.46)	160 (6.30)	NSYMM32	-	-	NSYMR32	NSYMB32	NSYMPP32	-	NSYCS200PLM
308 (12.13)	255 (10.04)	160 (6.30)	NSYMM3025	-	-	NSYMR3025	NSYMB3025	NSYMPP3025	-	-
430 (16.93)	330 (12.99)	200 (7.87)	NSYMM43	NSYMS43	NSYMF43	NSYMR43	NSYMB43	NSYMPP43	NSYDPLM200	NSYCS300PLM
530 (20.87)	430 (16.93)	200 (7.87)	NSYMM54	NSYMS54	NSYMF54	NSYMR54	NSYMB54	NSYMPP54	NSYDPLM200	NSYCS400PLM
647 (25.47)	436 (17.16)	250 (9.84)	NSYMM64	NSYMS64	NSYMF64	NSYMR64	NSYMB64	NSYMPP64	NSYDPLM250	NSYCS400PLM
747 (29.41)	536 (21.10)	300 (11.81)	NSYMM75	NSYMS75	NSYMF75	NSYMR75	NSYMB75	NSYMPP75	NSYDPLM300	NSYCS500PLM
847 (33.35)	636 (25.04)	300 (11.81)	NSYMM86	NSYMS86	NSYMF86	NSYMR86	NSYMB86	NSYMPP86	NSYDPLM300	NSYCS600PLM
1056 (41.58)	852 (33.54)	350 (13.78)	NSYMM108	-	NSYMF108	NSYMR108	NSYMB108	NSYMPP108	NSYDPLM350	NSYCS800PLM
Details			see page 240				see page 241		see page 208	

Main accessories

Dimensions			Fixing lugs	Postfixing device	Floormounting pillar	Internal door	Blanking plates	Plinth ZM RAL 7032
Height mm (in.)	Width mm (in.)	Depth mm (in.)						
310 (12.20)	215 (8.46)	160 (6.30)	NSYFPFLM32G	-	-	-	NSYCEPLMAG	-
308 (12.13)	255 (10.04)	160 (6.30)	NSYFPFLMG	-	-	NSYPA3025PLMG	-	-
430 (16.93)	330 (12.99)	200 (7.87)	NSYFPFLMG	NSYSFP300	-	NSYPAP43G	NSYCEPLMBG	-
530 (20.87)	430 (16.93)	200 (7.87)	NSYFPFLMG	NSYSFP400	NSYSFSPLMG	NSYPAP54G	NSYCEPLMBG	-
647 (25.47)	436 (17.16)	250 (9.84)	NSYFPFLMG	NSYSFP400	NSYSFSPLMG	NSYPAP64G	NSYCEPLMCG	-
747 (29.41)	536 (21.10)	300 (11.81)	NSYFPFLMG	NSYSFP500	-	NSYPAP75G	NSYCEPLMCG	NSYZM253G
847 (33.35)	636 (25.04)	300 (11.81)	NSYFPFLMG	NSYSFP600	-	NSYPAP86G	NSYCEPLMCG	NSYZM263G
1056 (41.58)	852 (33.54)	350 (13.78)	NSYFPFLMG	-	-	NSYPAP108G	-	NSYZM283G
Details			see page 202			see page 203	see page 202	see page 201

Water drain plug: [Page 209](#)
 Rail-fixing nuts: [Page 208](#)
 Airing louver: [Page 209](#)

Polyester Floor-Standing Enclosures



Indoor and Outdoor:
Outdoor use requires the installation of a canopy.

Completely sealed enclosures, IP65

Enclosures with open bottom part, IP54



PLA



PLA



PLAZ

Dimensions				Completely sealed enclosures, IP65		Enclosures with open bottom part, IP54
Height mm (in.)	Width mm (in.)	Depth mm (in.)	N° of doors	Plain	Glazed**	Plain
500 (19.68)	500 (19.68)	320 (12.60)	1	NSYPLA553G	NSYPLA553TG	NSYPLAZ553G
500 (19.68)	500 (19.68)	420 (16.54)	1	NSYPLA554G	NSYPLA554TG	NSYPLAZ554G
500 (19.68)	750 (29.53)	320 (12.60)	1	NSYPLA573G	NSYPLA573TG	NSYPLAZ573G
500 (19.68)	750 (29.53)	420 (16.54)	1	NSYPLA574G	NSYPLA574TG	NSYPLAZ574G
500 (19.68)	1000 (39.37)	320 (12.60)	2	NSYPLA5103G	NSYPLA5103TG	NSYPLAZ5103G
500 (19.68)	1000 (39.37)	420 (16.54)	2	NSYPLA5104G	NSYPLA5104TG	NSYPLAZ5104G
500 (19.68)	1250 (49.21)	320 (12.60)	2	NSYPLA5123G	NSYPLA5123TG	NSYPLAZ5123G
500 (19.68)	1250 (49.21)	420 (16.54)	2	NSYPLA5124G	NSYPLA5124TG	NSYPLAZ5124G
750 (29.53)	500 (19.68)	320 (12.60)	1	NSYPLA753G	NSYPLA753TG	NSYPLAZ753G
750 (29.53)	500 (19.68)	420 (16.54)	1	NSYPLA754G	NSYPLA754TG	NSYPLAZ754G
750 (29.53)	750 (29.53)	320 (12.60)	1	NSYPLA773G	NSYPLA773TG	NSYPLAZ773G
750 (29.53)	750 (29.53)	420 (16.54)	1	NSYPLA774G	NSYPLA774TG	NSYPLAZ774G
750 (29.53)	750 (29.53)	620 (24.41)	1	NSYPLA776G	NSYPLA776TG	NSYPLAZ776G
750 (29.53)	1000 (39.37)	320 (12.60)	2	NSYPLA7103G	NSYPLA7103TG	NSYPLAZ7103G
750 (29.53)	1000 (39.37)	420 (16.54)	2	NSYPLA7104G	NSYPLA7104TG	NSYPLAZ7104G
750 (29.53)	1250 (49.21)	320 (12.60)	2	NSYPLA7123G	NSYPLA7123TG	NSYPLAZ7123G
750 (29.53)	1250 (49.21)	420 (16.54)	2	NSYPLA7124G	NSYPLA7124TG	NSYPLAZ7124G
1000 (39.37)	500 (19.68)	320 (12.60)	1	NSYPLA1053G	NSYPLA1053TG	NSYPLAZ1053G
1000 (39.37)	500 (19.68)	420 (16.54)	1	NSYPLA1054G	NSYPLA1054TG	NSYPLAZ1054G
1000 (39.37)	750 (29.53)	320 (12.60)	1	NSYPLA1073G	NSYPLA1073TG	NSYPLAZ1073G
1000 (39.37)	750 (29.53)	420 (16.54)	1	NSYPLA1074G	NSYPLA1074TG	NSYPLAZ1074G
1000 (39.37)	1000 (39.37)	320 (12.60)	2	NSYPLA10103G	NSYPLA10103TG	NSYPLAZ10103G
1000 (39.37)	1000 (39.37)	420 (16.54)	2	NSYPLA10104G	NSYPLA10104TG	NSYPLAZ10104G
1000 (39.37)	1250 (49.21)	320 (12.60)	2	NSYPLA10123G	NSYPLA10123TG	NSYPLAZ10123G
1000 (39.37)	1250 (49.21)	420 (16.54)	2	NSYPLA10124G	NSYPLA10124TG	NSYPLAZ10124G
1250 (49.21)	500 (19.68)	320 (12.60)	1	NSYPLA1253G	NSYPLA1253TG	NSYPLAZ1253G
1250 (49.21)	500 (19.68)	420 (16.54)	1	NSYPLA1254G	NSYPLA1254TG	NSYPLAZ1254G
1250 (49.21)	750 (29.53)	320 (12.60)	1	NSYPLA1273G	NSYPLA1273TG	NSYPLAZ1273G
1250 (49.21)	750 (29.53)	420 (16.54)	1	NSYPLA1274G	NSYPLA1274TG	NSYPLAZ1274G
1250 (49.21)	750 (29.53)	620 (24.41)	1	NSYPLA1276G	NSYPLA1276TG	NSYPLAZ1276G
1250 (49.21)	1000 (39.37)	320 (12.60)	2	NSYPLA12103G	NSYPLA12103TG	NSYPLAZ12103G
1250 (49.21)	1000 (39.37)	420 (16.54)	2	NSYPLA12104G	NSYPLA12104TG	NSYPLAZ12104G
1250 (49.21)	1250 (49.21)	320 (12.60)	2	NSYPLA12123G	NSYPLA12123TG	NSYPLAZ12123G
1250 (49.21)	1250 (49.21)	420 (16.54)	2	NSYPLA12124G	NSYPLA12124TG	NSYPLAZ12124G
1250 (49.21)	1250 (49.21)	620 (24.41)	2	NSYPLA12126G	NSYPLA12126TG	NSYPLAZ12126G
1500 (59.06)	500 (19.68)	320 (12.60)	1	NSYPLA1553G	NSYPLA1553TG	NSYPLAZ1553G
1500 (59.06)	500 (19.68)	420 (16.54)	1	NSYPLA1554G	NSYPLA1554TG	NSYPLAZ1554G
1500 (59.06)	750 (29.53)	320 (12.60)	1	NSYPLA1573G	NSYPLA1573TG	NSYPLAZ1573G
1500 (59.06)	750 (29.53)	420 (16.54)	1	NSYPLA1574G	NSYPLA1574TG	NSYPLAZ1574G
1500 (59.06)	750 (29.53)	620 (24.41)	1	NSYPLA1576G	NSYPLA1576TG	NSYPLAZ1576G
1500 (59.06)	1000 (39.37)	320 (12.60)	2	NSYPLA15103G	NSYPLA15103TG	NSYPLAZ15103G
1500 (59.06)	1000 (39.37)	420 (16.54)	2	NSYPLA15104G	NSYPLA15104TG	NSYPLAZ15104G
1500 (59.06)	1250 (49.21)	320 (12.60)	2	NSYPLA15123G	NSYPLA15123TG	NSYPLAZ15123G
1500 (59.06)	1250 (49.21)	420 (16.54)	2	NSYPLA15124G	NSYPLA15124TG	NSYPLAZ15124G
1500 (59.06)	1250 (49.21)	620 (24.41)	2	NSYPLA15126G	NSYPLA15126TG	NSYPLAZ15126G
2000 (78.74)	750 (29.53)	420 (16.54)	2*	NSYPLA2074G	NSYPLA2074TG	NSYPLAZ2074G

*Two doors in vertical.

**Recommended to protect against the direct UV radiation.

PHD - Applicative solutions:

See the Polyester Heavy-Duty offer in the Applicative solutions, [page 324](#).

Technical changes reserved. Information provided without guarantee. Images are for illustrative purposes only.



Indoor and Outdoor:
Outdoor use requires the installation of a canopy.

Enclosures with ventilated canopy, IP44



PLAT

Enclosures with open bottom part and ventilated canopy, IP44



PLAzt

Dimensions				Plain	Plain
Height mm (in.)	Width mm (in.)	Depth mm (in.)	N° of doors		
500 (19.68)	500 (19.68)	320 (12.60)	1	NSYPLAT553G	NSYPLAZT553G
500 (19.68)	500 (19.68)	420 (16.54)	1	NSYPLAT554G	NSYPLAZT554G
500 (19.68)	750 (29.53)	320 (12.60)	1	NSYPLAT573G	NSYPLAZT573G
500 (19.68)	750 (29.53)	420 (16.54)	1	NSYPLAT574G	NSYPLAZT574G
500 (19.68)	1000 (39.37)	320 (12.60)	2	NSYPLAT5103G	NSYPLAZT5103G
500 (19.68)	1000 (39.37)	420 (16.54)	2	NSYPLAT5104G	NSYPLAZT5104G
500 (19.68)	1250 (49.21)	320 (12.60)	2	NSYPLAT5123G	NSYPLAZT5123G
500 (19.68)	1250 (49.21)	420 (16.54)	2	NSYPLAT5124G	NSYPLAZT5124G
750 (29.53)	500 (19.68)	320 (12.60)	1	NSYPLAT753G	NSYPLAZT753G
750 (29.53)	500 (19.68)	420 (16.54)	1	NSYPLAT754G	NSYPLAZT754G
750 (29.53)	750 (29.53)	320 (12.60)	1	NSYPLAT773G	NSYPLAZT773G
750 (29.53)	750 (29.53)	420 (16.54)	1	NSYPLAT774G	NSYPLAZT774G
750 (29.53)	750 (29.53)	620 (24.41)	1	NSYPLAT776G	NSYPLAZT776G
750 (29.53)	1000 (39.37)	320 (12.60)	2	NSYPLAT7103G	NSYPLAZT7103G
750 (29.53)	1000 (39.37)	420 (16.54)	2	NSYPLAT7104G	NSYPLAZT7104G
750 (29.53)	1250 (49.21)	320 (12.60)	2	NSYPLAT7123G	NSYPLAZT7123G
750 (29.53)	1250 (49.21)	420 (16.54)	2	NSYPLAT7124G	NSYPLAZT7124G
1000 (39.37)	500 (19.68)	320 (12.60)	1	NSYPLAT1053G	NSYPLAZT1053G
1000 (39.37)	500 (19.68)	420 (16.54)	1	NSYPLAT1054G	NSYPLAZT1054G
1000 (39.37)	750 (29.53)	320 (12.60)	1	NSYPLAT1073G	NSYPLAZT1073G
1000 (39.37)	750 (29.53)	420 (16.54)	1	NSYPLAT1074G	NSYPLAZT1074G
1000 (39.37)	1000 (39.37)	320 (12.60)	2	NSYPLAT10103G	NSYPLAZT10103G
1000 (39.37)	1000 (39.37)	420 (16.54)	2	NSYPLAT10104G	NSYPLAZT10104G
1000 (39.37)	1250 (49.21)	320 (12.60)	2	NSYPLAT10123G	NSYPLAZT10123G
1000 (39.37)	1250 (49.21)	420 (16.54)	2	NSYPLAT10124G	NSYPLAZT10124G
1250 (49.21)	500 (19.68)	320 (12.60)	1	NSYPLAT1253G	NSYPLAZT1253G
1250 (49.21)	500 (19.68)	420 (16.54)	1	NSYPLAT1254G	NSYPLAZT1254G
1250 (49.21)	750 (29.53)	320 (12.60)	1	NSYPLAT1273G	NSYPLAZT1273G
1250 (49.21)	750 (29.53)	420 (16.54)	1	NSYPLAT1274G	NSYPLAZT1274G
1250 (49.21)	750 (29.53)	620 (24.41)	1	NSYPLAT1276G	NSYPLAZT1276G
1250 (49.21)	1000 (39.37)	320 (12.60)	2	NSYPLAT12103G	NSYPLAZT12103G
1250 (49.21)	1000 (39.37)	420 (16.54)	2	NSYPLAT12104G	NSYPLAZT12104G
1250 (49.21)	1250 (49.21)	320 (12.60)	2	NSYPLAT12123G	NSYPLAZT12123G
1250 (49.21)	1250 (49.21)	420 (16.54)	2	NSYPLAT12124G	NSYPLAZT12124G
1250 (49.21)	1250 (49.21)	620 (24.41)	2	NSYPLAT12126G	NSYPLAZT12126G
1500 (59.06)	500 (19.68)	320 (12.60)	1	NSYPLAT1553G	NSYPLAZT1553G
1500 (59.06)	500 (19.68)	420 (16.54)	1	NSYPLAT1554G	NSYPLAZT1554G
1500 (59.06)	750 (29.53)	320 (12.60)	1	NSYPLAT1573G	NSYPLAZT1573G
1500 (59.06)	750 (29.53)	420 (16.54)	1	NSYPLAT1574G	NSYPLAZT1574G
1500 (59.06)	750 (29.53)	620 (24.41)	1	NSYPLAT1576G	NSYPLAZT1576G
1500 (59.06)	1000 (39.37)	320 (12.60)	2	NSYPLAT15103G	NSYPLAZT15103G
1500 (59.06)	1000 (39.37)	420 (16.54)	2	NSYPLAT15104G	NSYPLAZT15104G
1500 (59.06)	1250 (49.21)	320 (12.60)	2	NSYPLAT15123G	NSYPLAZT15123G
1500 (59.06)	1250 (49.21)	420 (16.54)	2	NSYPLAT15124G	NSYPLAZT15124G
1500 (59.06)	1250 (49.21)	620 (24.41)	2	NSYPLAT15126G	NSYPLAZT15126G
2000 (78.74)	750 (29.53)	420 (16.54)	2*	NSYPLAT2074G	NSYPLAZT2074G

*Two doors in vertical.

PHD - Applicative solutions:

See the Polyester Heavy-Duty offer in the Applicative solutions, [page 324](#).









Technical changes reserved. Information provided without guarantee. Images are for illustrative purposes only.

Mounting accessories

Dimensions			Metal mounting plates		Insulated mounting plates		Internal door
Height mm (in.)	Width mm (in.)	No. of doors	Plain	Telequick	Polyester	Bakelite	
500 (19.68)	500 (19.68)	1	NSYPMM55	NSYPMR55	NSYPMA55	NSYPMB55	NSYPAPLA55G
500 (19.68)	750 (29.53)	1	NSYPMM75	NSYPMR57	NSYPMA75	NSYPMB75	NSYPAPLA57G
500 (19.68)	1000 (39.37)	2	NSYPMM510	2 x NSYPMR55	NSYPMA510	NSYPMB510	2 x NSYPAPLA55G
500 (19.68)	1250 (49.21)	2	NSYPMM55 + NSYPMM75	NSYPMR55 + NSYPMR57	NSYPMA55 + NSYPMA75	NSYPMB55 + NSYPMB75	NSYPAPLA55G + NSYPAPLA57G
750 (29.53)	500 (19.68)	1	NSYPMM75	NSYPMR75	NSYPMA75	NSYPMB75	NSYPAPLA75G
750 (29.53)	750 (29.53)	1	NSYPMM77	NSYPMR77	NSYPMA77	NSYPMB77	NSYPAPLA77G
750 (29.53)	1000 (39.37)	2	NSYPMM710	2 x NSYPMR75	NSYPMA710	NSYPMB710	2 x NSYPAPLA75G
750 (29.53)	1250 (49.21)	2	NSYPMM712	NSYPMR75 + NSYPMR77	NSYPMA712	NSYPMB712	NSYPAPLA75G + NSYPAPLA77G
1000 (39.37)	500 (19.68)	1	NSYPMM105	NSYPMR105	NSYPMA105	NSYPMB105	NSYPAPLA105G
1000 (39.37)	750 (29.53)	1	NSYPMM107	NSYPMR107	NSYPMA107	NSYPMB107	NSYPAPLA107G
1000 (39.37)	1000 (39.37)	2	NSYPMM1010	2 x NSYPMR105	NSYPMA1010	NSYPMB1010	2 x NSYPAPLA105G
1000 (39.37)	1250 (49.21)	2	NSYPMM1012	NSYPMR105 + NSYPMR107	NSYPMA1012	NSYPMB1012	NSYPAPLA105G + NSYPAPLA107G
1250 (49.21)	500 (19.68)	1	NSYPMM125	NSYPMR125	NSYPMA125	NSYPMB125	NSYPAPLA125G
1250 (49.21)	750 (29.53)	1	NSYPMM127	NSYPMR127	NSYPMA127	NSYPMB127	NSYPAPLA127G
1250 (49.21)	1000 (39.37)	2	NSYPMM1210	2 x NSYPMR125	NSYPMA1210	NSYPMB1210	2 x NSYPAPLA125G
1250 (49.21)	1250 (49.21)	2	NSYPMM1212	NSYPMR125 + NSYPMR127	NSYPMA1212	NSYPMB1212	NSYPAPLA125G + NSYPAPLA127G
1500 (59.06)	500 (19.68)	1	NSYPMM155	NSYPMR155	-	NSYPMB155	NSYPAPLA155G
1500 (59.06)	750 (29.53)	1	NSYPMM157	NSYPMR157	-	NSYPMB157	NSYPAPLA157G
1500 (59.06)	1000 (39.37)	2	NSYPMM1510	2 x NSYPMR155	-	NSYPMB1510	2 x NSYPAPLA155G
1500 (59.06)	1250 (49.21)	2	NSYPMM1512	NSYPMR155 + NSYPMR157	-	NSYPMB1512	NSYPAPLA155G + NSYPAPLA157G
2000 (78.74)	750 (29.53)	2	NSYPMM207	2 x NSYPMR107	2 x NSYPMA107	2 x NSYPMB107	-
Details			see page 228		see page 228		see page 224

Step slides: [Page 230](#)
 Uprights and mounting rails: [Page 250](#)
 Door retainer: [Page 224](#)

Composition accessories

		N plinth	H plinth	ZA plinth	ZZ plinth		Floor-fixing frame	Canopy	Cable entry plate
									
Dimensions									
Width mm (in.)	Depth mm (in.)	Height 60 (2.36) mm (in.)	Height 900 (35.43) mm (in.)	Height 200 (7.87) mm (in.)	Height 200 (7.87) mm (in.)	Height 500 (19.68) mm (in.)			
500 (19.68)	320 (12.60)	NSYZNPLA53G	NSYZHPLA53G	NSYZA253G	NSYZZ253G	NSYZZ553G	NSYMFPLAZ53	NSYTJPLA53G	NSYECPLAZ53G
500 (19.68)	420 (16.54)	NSYZNPLA54G	NSYZHPLA54G	NSYZA254G	NSYZZ254G	NSYZZ554G	NSYMFPLAZ54	NSYTJPLA54G	NSYECPLAZ54G
500 (19.68)	320 (12.60)	NSYZNPLA73G	NSYZHPLA73G	NSYZA273G	NSYZZ273G	NSYZZ573G	NSYMFPLAZ73	NSYTJPLA73G	NSYECPLAZ73G
500 (19.68)	420 (16.54)	NSYZNPLA74G	NSYZHPLA74G	NSYZA274G	NSYZZ274G	NSYZZ574G	NSYMFPLAZ74	NSYTJPLA74G	NSYECPLAZ74G
750 (29.53)	620 (24.41)	-	-	NSYZA276G	NSYZZ276G	-	NSYMFPLAZ76	NSYTJPLA76G	NSYECPLAZ76G
750 (29.53)	320 (12.60)	NSYZNPLA103G	NSYZHPLA103G	NSYZA2103G	NSYZZ2103G	NSYZZ5103G	NSYMFPLAZ103	NSYTJPLA103G	NSYECPLAZ103G
750 (29.53)	420 (16.54)	NSYZNPLA104G	NSYZHPLA104G	NSYZA2104G	NSYZZ2104G	NSYZZ5104G	NSYMFPLAZ104	NSYTJPLA104G	NSYECPLAZ104G
750 (29.53)	320 (12.60)	NSYZNPLA123G	NSYZHPLA123G	NSYZA2123G	NSYZZ2123G	NSYZZ5123G	NSYMFPLAZ123	NSYTJPLA123G	NSYECPLAZ123G
1000 (39.37)	420 (16.54)	NSYZNPLA124G	NSYZHPLA124G	NSYZA2124G	NSYZZ2124G	NSYZZ5124G	NSYMFPLAZ124	NSYTJPLA124G	NSYECPLAZ124G
1000 (39.37)	620 (24.41)	-	-	NSYZA2126G	NSYZZ2126G	-	NSYMFPLAZ126	NSYTJPLA126G	NSYECPLAZ126G
Details		see page 221	see page 223	see page 220	see page 222		see page 223	see page 219	see page 219

VDI accessories

19" fixed chassis			
			
Dimensions			
Height mm (in.)	Width mm (in.)	Number of U	References
500 (19.68)	750 (29.53)	8	NSYBRF8PLAG
750 (29.53)	750 (29.53)	12	NSYBRF12PLAG + NSYSPLA75
1000 (39.37)	750 (29.53)	17	NSYBRF17PLAG + NSYSPLA100
1250 (49.21)	750 (29.53)	21	NSYBRF21PLAG + NSYSPLA125
1500 (59.06)	750 (29.53)	26	NSYBRF26PLAG + NSYSPLA150*
2000 (78.74)	750 (29.53)	2 x 17	2 x NSYBRF17PLAG + 2 x NSYSPLA100 + NSYPTZ4
Details		see page 227	

* not compatible with **NSYCAAPVHD**

Door switch: [Page 224](#)
 Insert: [Page 231](#)
 Document pocket: [Page 298](#)

VDI accessories and fixings: [Page 269](#)
 Coupling Kit: [Page 218](#)

Handles and inserts: [Page 225](#)
 Wall fixing lug: [Page 219](#)

Steel Industrial Boxes

Spacial SDB metal junction boxes



Steel industrial boxes



Spacial SDB

Metal junction boxes	36
----------------------	----

Spacial SBM

Introduction	38
Characteristics	39
Spacial SBM overview	40
Fixing accessories	42

Dimensions

Dimensions	45
------------	----

Metal junction boxes

- PVC sealing gasket for sizes up to 20/15 and a rubber gasket for sizes > 25/20.
- Back ready for threaded drill holes for fixing equipment. From size 15/10 and up, there are four M4 threaded holes fitted with removable plugs for direct fixing of the mounting plate.
- With low cover.
- The SDB series consists of 2 basic models:
- Without knock-outs: **NSYDB●●●●**
- With knock-outs: **NSYDB●●●●M**
- Material: Sheet steel
- Finish: Structured finish, epoxy polyester powder
- Color: RAL 7035 grey
- Ingress protection rating: IP55 according to IEC 60529
- Mechanical protection rating: IK07 according to IEC 62262
- Installation: Indoor installation: Direct wall-mounted by means of drill holes fitted with plastic plugs to ensure sealing compliant with IEC 62208 regarding type tests specified in §9.12 (resistance to ultra-violet (UV) radiation) and §9.13 (resistance to corrosion).

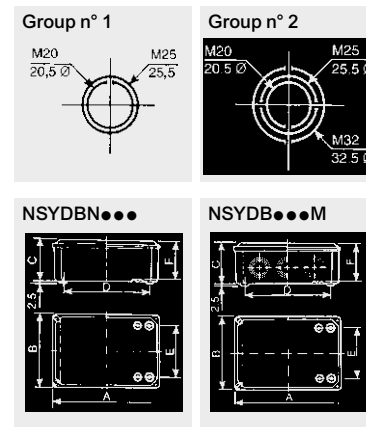

Low cover models without knock-outs



NSYDBN1510

	External dimensions mm (in.)			Dimensions mm (in.)			Weight kg (lbs.)	References
	Height (A)	Width (B)	Depth (C)	D	E	F		
	85 (3.35)	85 (3.35)	49 (1.93)	58 (2.28)	58 (2.28)	-	0.18 (0.40)	NSYDBN88
	105 (4.13)	105 (4.13)	49 (1.93)	76 (2.99)	76 (2.99)	-	0.25 (0.55)	NSYDBN1010
	155 (6.10)	105 (4.13)	61 (2.40)	124 (4.88)	74 (2.91)	56 (2.20)	0.38 (0.84)	NSYDBN1510
	206 (8.11)	156 (6.14)	83 (3.27)	172 (6.77)	122 (4.80)	78 (3.07)	1.00 (2.20)	NSYDBN2015
	256 (10.08)	206 (8.11)	93 (3.66)	220 (8.66)	170 (6.69)	88 (3.46)	1.5 (3.31)	NSYDBN2520
	307 (12.09)	257 (10.12)	116 (4.57)	268 (10.55)	218 (8.58)	110 (4.33)	3.3 (7.28)	NSYDBN3025

Low cover models with knock-outs



NSYDB2015M

	External dimensions mm (in.)			Dimensions mm (in.)			Knock-outs		Weight kg (lbs.)	References
	Height (A)	Width (B)	Depth (C)	D	E	F	Height (A)	Width (B)		
	85 (3.35)	85 (3.35)	49 (1.93)	58 (2.28)	58 (2.28)	-	1 n° 1	1 n° 1	0.18 (0.40)	NSYDB88M
	105 (4.13)	105 (4.13)	49 (1.93)	76 (2.99)	76 (2.99)	-	2 n° 1	1 n° 1	0.25 (0.55)	NSYDB1010M
	155 (6.10)	105 (4.13)	61 (2.40)	124 (4.88)	74 (2.91)	56 (2.20)	3 n° 1	1 n° 1	0.38 (0.84)	NSYDB1510M
	206 (8.11)	156 (6.14)	83 (3.27)	172 (6.77)	122 (4.80)	78 (3.07)	3 n° 2	2 n° 2	1.00 (2.20)	NSYDB2015M

Metal Junction Boxes

Spacial SDB

Plain mounting plates for SDB junction boxes

for models without knock-outs	for models with knock-outs	References
NSYDBN1510	NSYDB1510M	NSYPMD1510
NSYDBN2015	NSYDB2015M	NSYPMD2015
NSYDBN2520	-	NSYPMD2520
NSYDBN3025	-	NSYPMD3025

Simplicity, ergonomics and versatility, it's all in the box.



Modularity

- 28 sizes available.

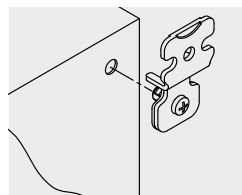

Easy installation

- Direct mounting through the rear.
- Mounting with versatile external lugs.



Added value to your work

- Quality and aesthetics.

Sturdy and good ingress protection

- Mechanical protection rating up to IK10.
- Ingress protection rating up to IP66.



Ergonomics

- Cover opening and accessory mounting with just a screwdriver.



Characteristics	Spacial SBM - Flat box with plain cover
Box body	Single-piece body (cross-shaped structure). Front design incorporating folded gutters. Flat rear. 2 (or 3 profiles for width 800 (31.50) mm (in.)) drilled profiles for installing mounting plates and DIN rails, with mounting centers of 125 (4.92) mm (in.).
Box cover	Equipped with 4 or 6 half-turn thread screws, according to the version (6 screws for width greater than 400 (15.75) mm (in.)) to ensure maximum watertightness. Polyurethane sealing gasket.
Protection of personnel	Ground connection mandatory for all boxes: Spacial SBM steel boxes are equipped with a M6 x 16 ground stud welded in the cover, to be linked with the body for equipotential connection. Grounding strap to be ordered separately (Ø 6,4 (0.25) mm (in.) terminal).
Material	Sheet steel
Finish	Structured finish, epoxy polyester powder
Color	RAL 7035 grey
Ingress protection rating	<ul style="list-style-type: none"> • IP66 according to IEC 60529 • Type 4, 4X according to UL 50, 50E
Mechanical protection rating	IK10 according to IEC 62262
Standard	Compliance with enclosure standard IEC 62208 and the RoHS directive
Certifications (see page 506)	<ul style="list-style-type: none"> • UL, BV, LR, DNV-GL • Fire class: M0 (EN 13501-1)
Indoor installation	Direct wall-mounted (4 x Ø 10 (0.39) mm (in.) holes) or with mounting lugs installed from the outside (to be ordered separately, see specific accessory pages).
Maximum load	Loading capacity on the body: 50 (110.23) kg (lbs.)/m ²
Vibration constraints	Specific construction of the Spacial SBM - Single-piece body (rectangular structure). The rear is flat without added parts - this ensures compliance with certain vibration constraints.
Seismic behaviour	The seismic behavior of the the industrial boxes Spacial SBM have been qualified according to MRI spectra "big material" specified in the standard IEC 60068-2-6 and IEC 60068-2-57 (see page 340 for more details). Tested enclosure configuration: <ul style="list-style-type: none"> • Plain door, • Plain mounting plate with a load of 200 (440.92) kg (lbs.)/m² uniformly distributed on the mounting plate, • Fixing to the wall with M8 screws (tightening torque: 12 Nm ± 1 Nm). Level of the seismic behavior obtained: <ul style="list-style-type: none"> • 1G for boxes with the following dimensions: <ul style="list-style-type: none"> - height = 400 (15.75) mm (in.) and width ≥ 500 (19.68) mm (in.) - height = 300 (11.81) mm (in.) and width ≥ 600 (23.62) mm (in.) - height = 200 (7.87) mm (in.) and width = 800 (31.50) mm (in.) • 3G for other dimension

SBM



Standard Bus box
phased out

Dimensions mm (in.)			Cover screws Bus Boxes phased out divide by 2	Flat box	Mounting plate without screws	DIN rail 10 rails, supplied without screws	Post mounting
Height	Width	Depth					
150 (5.91)	150 (5.91)	80 (3.15)	4	NSYSBM15158	NSYMM11SB	NSYAMRD15357SB	NSYSFPSC15
150 (5.91)	150 (5.91)	120 (4.72)	4	NSYSBM151512	NSYMM11SB	NSYAMRD15357SB	NSYSFPSC15
150 (5.91)	200 (7.87)	80 (3.15)	4	NSYSBM15208	NSYMM12SB	NSYAMRD20357SB	NSYSFPSC20
150 (5.91)	200 (7.87)	120 (4.72)	4	NSYSBM152012	NSYMM12SB	NSYAMRD20357SB	NSYSFPSC20
150 (5.91)	300 (11.81)	80 (3.15)	4	NSYSBM15308	NSYMM13SB	NSYAMRD30357SB	NSYSFPSC30
150 (5.91)	300 (11.81)	120 (4.72)	4	NSYSBM153012	NSYMM13SB	NSYAMRD30357SB	NSYSFPSC30
150 (5.91)	400 (15.75)	80 (3.15)	4	NSYSBM15408	NSYMM14SB	NSYAMRD40357SB	NSYSFPSC40
150 (5.91)	400 (15.75)	120 (4.72)	4	NSYSBM154012	NSYMM14SB	NSYAMRD40357SB	NSYSFPSC40
200 (7.87)	200 (7.87)	80 (3.15)	4	NSYSBM20208	NSYMM22SB	NSYAMRD20357SB	NSYSFPSC20
200 (7.87)	200 (7.87)	120 (4.72)	4	NSYSBM202012	NSYMM22SB	NSYAMRD20357SB	NSYSFPSC20
200 (7.87)	300 (11.81)	80 (3.15)	4	NSYSBM20308	NSYMM23SB	NSYAMRD30357SB	NSYSFPSC30
200 (7.87)	300 (11.81)	120 (4.72)	4	NSYSBM203012	NSYMM23SB	NSYAMRD30357SB	NSYSFPSC30
200 (7.87)	400 (15.75)	80 (3.15)	4	NSYSBM20408	NSYMM24SB	NSYAMRD40357SB	NSYSFPSC40
200 (7.87)	400 (15.75)	120 (4.72)	4	NSYSBM204012	NSYMM24SB	NSYAMRD40357SB	NSYSFPSC40
200 (7.87)	500 (19.68)	80 (3.15)	6	NSYSBM20508	NSYMM25SB	NSYAMRD50357SB	NSYSFPSC50
200 (7.87)	500 (19.68)	120 (4.72)	6	NSYSBM205012	NSYMM25SB	NSYAMRD50357SB	NSYSFPSC50
200 (7.87)	600 (23.62)	80 (3.15)	6	NSYSBM20608	NSYMM26SB	NSYAMRD60357SB	NSYSFPSC60
200 (7.87)	600 (23.62)	120 (4.72)	6	NSYSBM206012	NSYMM26SB	NSYAMRD60357SB	NSYSFPSC60
200 (7.87)	800 (31.50)	120 (4.72)	6	NSYSBM208012	NSYMM28SB	NSYAMRD80357SB	NSYSFPSC80
300 (11.81)	300 (11.81)	120 (4.72)	4	NSYSBM303012	NSYMM33SB	NSYAMRD30357SB	NSYSFPSC30
300 (11.81)	400 (15.75)	120 (4.72)	4	NSYSBM304012	NSYMM34SB	NSYAMRD40357SB	NSYSFPSC40
300 (11.81)	500 (19.68)	120 (4.72)	6	NSYSBM305012	NSYMM35SB	NSYAMRD50357SB	NSYSFPSC50
300 (11.81)	600 (23.62)	120 (4.72)	6	NSYSBM306012	NSYMM36SB	NSYAMRD60357SB	NSYSFPSC60
300 (11.81)	800 (31.50)	120 (4.72)	6	NSYSBM308012	NSYMM38SB	NSYAMRD80357SB	NSYSFPSC80
400 (15.75)	400 (15.75)	120 (4.72)	4	NSYSBM404012	NSYMM44SB	NSYAMRD40357SB	NSYSFPSC40
400 (15.75)	500 (19.68)	120 (4.72)	6	NSYSBM405012	NSYMM45SB	NSYAMRD50357SB	NSYSFPSC50
400 (15.75)	600 (23.62)	120 (4.72)	6	NSYSBM406012	NSYMM46SB	NSYAMRD60357SB	NSYSFPSC60
400 (15.75)	800 (31.50)	120 (4.72)	6	NSYSBM408012	NSYMM48SB	NSYAMRD80357SB	NSYSFPSC80

Flat boxes (SBM)



NSYSBM15158

Characteristics	Height mm (in.)	Width mm (in.)	Depth mm (in.)	Power dissipation	Sheet thickness	References
Flat box IP66 IK10 RAL 7035, 4 screws f. cover	150 (5.91)	150 (5.91)	80 (3.15)	13.5	10/10 ^e	NSYSBM15158
Flat box IP66 IK10 RAL 7035, 4 screws f. cover	150 (5.91)	150 (5.91)	120 (4.72)	17.2	10/10 ^e	NSYSBM151512
Flat box IP66 IK10 RAL 7035, 4 screws f. cover	150 (5.91)	200 (7.87)	80 (3.15)	16.6	10/10 ^e	NSYSBM15208
Flat box IP66 IK10 RAL 7035, 4 screws f. cover	150 (5.91)	200 (7.87)	120 (4.72)	20.8	10/10 ^e	NSYSBM152012
Flat box IP66 IK10 RAL 7035, 4 screws f. cover	150 (5.91)	300 (11.81)	80 (3.15)	22.8	10/10 ^e	NSYSBM15308
Flat box IP66 IK10 RAL 7035, 4 screws f. cover	150 (5.91)	300 (11.81)	120 (4.72)	28.1	10/10 ^e	NSYSBM153012
Flat box IP66 IK10 RAL 7035, 4 screws f. cover	150 (5.91)	400 (15.75)	80 (3.15)	29.0	10/10 ^e	NSYSBM15408
Flat box IP66 IK10 RAL 7035, 4 screws f. cover	150 (5.91)	400 (15.75)	120 (4.72)	35.3	10/10 ^e	NSYSBM154012
Flat box IP66 IK10 RAL 7035, 4 screws f. cover	200 (7.87)	200 (7.87)	80 (3.15)	20.6	10/10 ^e	NSYSBM20208
Flat box IP66 IK10 RAL 7035, 4 screws f. cover	200 (7.87)	200 (7.87)	120 (4.72)	25.6	10/10 ^e	NSYSBM202012
Flat box IP66 IK10 RAL 7035, 4 screws f. cover	200 (7.87)	300 (11.81)	80 (3.15)	28.2	10/10 ^e	NSYSBM20308
Flat box IP66 IK10 RAL 7035, 4 screws f. cover	200 (7.87)	300 (11.81)	120 (4.72)	34.2	10/10 ^e	NSYSBM203012
Flat box IP66 IK10 RAL 7035, 4 screws f. cover	200 (7.87)	400 (15.75)	80 (3.15)	35.7	10/10 ^e	NSYSBM20408
Flat box IP66 IK10 RAL 7035, 4 screws f. cover	200 (7.87)	400 (15.75)	120 (4.72)	42.8	10/10 ^e	NSYSBM204012
Flat box IP66 IK10 RAL 7035, 6 screws f. cover	200 (7.87)	500 (19.68)	80 (3.15)	43.3	12/10 ^e	NSYSBM20508
Flat box IP66 IK10 RAL 7035, 6 screws f. cover	200 (7.87)	500 (19.68)	120 (4.72)	51.4	12/10 ^e	NSYSBM205012
Flat box IP66 IK10 RAL 7035, 6 screws f. cover	200 (7.87)	600 (23.62)	80 (3.15)	50.8	12/10 ^e	NSYSBM20608
Flat box IP66 IK10 RAL 7035, 6 screws f. cover	200 (7.87)	600 (23.62)	120 (4.72)	60.1	12/10 ^e	NSYSBM206012
Flat box IP66 IK10 RAL 7035, 6 screws f. cover	200 (7.87)	800 (31.50)	120 (4.72)	77.3	12/10 ^e	NSYSBM208012
Flat box IP66 IK10 RAL 7035, 4 screws f. cover	300 (11.81)	300 (11.81)	120 (4.72)	46.4	10/10 ^e	NSYSBM303012
Flat box IP66 IK10 RAL 7035, 4 screws f. cover	300 (11.81)	400 (15.75)	120 (4.72)	57.8	10/10 ^e	NSYSBM304012
Flat box IP66 IK10 RAL 7035, 6 screws f. cover	300 (11.81)	500 (19.68)	120 (4.72)	69.1	12/10 ^e	NSYSBM305012
Flat box IP66 IK10 RAL 7035, 6 screws f. cover	300 (11.81)	600 (23.62)	120 (4.72)	80.4	12/10 ^e	NSYSBM306012
Flat box IP66 IK10 RAL 7035, 6 screws f. cover	300 (11.81)	800 (31.50)	120 (4.72)	103.0	12/10 ^e	NSYSBM308012
Flat box IP66 IK10 RAL 7035, 4 screws f. cover	400 (15.75)	400 (15.75)	120 (4.72)	72.7	10/10 ^e	NSYSBM404012
Flat box IP66 IK10 RAL 7035, 6 screws f. cover	400 (15.75)	500 (19.68)	120 (4.72)	86.7	12/10 ^e	NSYSBM405012
Flat box IP66 IK10 RAL 7035, 6 screws f. cover	400 (15.75)	600 (23.62)	120 (4.72)	100.7	12/10 ^e	NSYSBM406012
Flat box IP66 IK10 RAL 7035, 6 screws f. cover	400 (15.75)	800 (31.50)	120 (4.72)	128.7	12/10 ^e	NSYSBM408012

Mounting plate

- Material: Galvanized steel
- Installation: Mounting by means of 2* or 4 x Ø 5 (0.20) mm (in.) self-tapping screws, Pozidriv head, ref. **NSYAMFSB**. Attachment points compatible with many other brands of accessories

Supply:

1 unit, supplied without screws



NSYMM11SB

Characteristics	Height mm (in.)	Width mm (in.)	References
Mounting plate	125 (4.92)	135 (5.32)	NSYMM11SB
Mounting plate	125 (4.92)	185 (7.28)	NSYMM12SB
Mounting plate	125 (4.92)	285 (11.22)	NSYMM13SB
Mounting plate	125 (4.92)	385 (15.16)	NSYMM14SB
Mounting plate	175 (6.89)	185 (7.28)	NSYMM22SB
Mounting plate	175 (6.89)	265 (10.43)	NSYMM23SB
Mounting plate	175 (6.89)	385 (15.16)	NSYMM24SB
Mounting plate	175 (6.89)	485 (19.09)	NSYMM25SB
Mounting plate	175 (6.89)	585 (23.03)	NSYMM26SB
Mounting plate	175 (6.89)	785 (30.91)	NSYMM28SB
Mounting plate	275 (10.83)	285 (11.22)	NSYMM33SB
Mounting plate	275 (10.83)	385 (15.16)	NSYMM34SB
Mounting plate	275 (10.83)	485 (19.09)	NSYMM35SB
Mounting plate	275 (10.83)	585 (23.03)	NSYMM36SB
Mounting plate	275 (10.83)	785 (30.91)	NSYMM38SB
Mounting plate	375 (14.76)	385 (15.16)	NSYMM44SB
Mounting plate	375 (14.76)	485 (19.09)	NSYMM45SB
Mounting plate	375 (14.76)	585 (23.03)	NSYMM46SB
Mounting plate	375 (14.76)	785 (30.91)	NSYMM48SB

Symmetrical DIN rails 35 x 7.5 mm

- Material: Galvanized steel
- Installation: Mounting by means of 2 x Ø 5 (0.20) mm (in.) self-tapping screws, Pozidriv head, ref. **NSYAMFSB**
- All boxes are delivered with 5 x Ø 5 (0.20) mm (in.) self-tapping screws.

Supply:

10 rails, supplied without screws



NSYAMRD15357SB

Characteristics	Height mm (in.)	Width mm (in.)	References
Symmetrical DIN rail	35 (1.38)	150 (5.91)	NSYAMRD15357SB
Symmetrical DIN rail	35 (1.38)	200 (7.87)	NSYAMRD20357SB
Symmetrical DIN rail	35 (1.38)	300 (11.81)	NSYAMRD30357SB
Symmetrical DIN rail	35 (1.38)	400 (15.75)	NSYAMRD40357SB
Symmetrical DIN rail	35 (1.38)	200 (7.87)	NSYAMRD20357SB
Symmetrical DIN rail	35 (1.38)	300 (11.81)	NSYAMRD30357SB
Symmetrical DIN rail	35 (1.38)	400 (15.75)	NSYAMRD40357SB
Symmetrical DIN rail	35 (1.38)	500 (19.68)	NSYAMRD50357SB
Symmetrical DIN rail	35 (1.38)	600 (23.62)	NSYAMRD60357SB
Symmetrical DIN rail	35 (1.38)	800 (31.50)	NSYAMRD80357SB
Symmetrical DIN rail	35 (1.38)	300 (11.81)	NSYAMRD30357SB
Symmetrical DIN rail	35 (1.38)	400 (15.75)	NSYAMRD40357SB
Symmetrical DIN rail	35 (1.38)	500 (19.68)	NSYAMRD50357SB
Symmetrical DIN rail	35 (1.38)	600 (23.62)	NSYAMRD60357SB
Symmetrical DIN rail	35 (1.38)	800 (31.50)	NSYAMRD80357SB
Symmetrical DIN rail	35 (1.38)	400 (15.75)	NSYAMRD40357SB
Symmetrical DIN rail	35 (1.38)	500 (19.68)	NSYAMRD50357SB
Symmetrical DIN rail	35 (1.38)	600 (23.62)	NSYAMRD60357SB
Symmetrical DIN rail	35 (1.38)	800 (31.50)	NSYAMRD80357SB

Post mounting

- Material: Zinc-plated steel
- Rail mounted externally to the rear of the box with 8 (0.32) mm (in.) screws for installation on posts with diameters between 150 (5.91) and 215 (8.46) mm (in.).
- For steel boxes with widths of 150 (5.91), 200 (7.87), 300 (11.81), 400 (15.75), 500 (19.68), 600 (23.62) and 800 (31.50) mm (in.).
- Maximum load: 100 (220.46) kg (lbs.)

Supply:

1 unit



NSYSFPSC15

Characteristics	Height mm (in.)	Width mm (in.)	References
Post mounting	45 (1.77)	150 (5.91)	NSYSFPSC15
Post mounting	45 (1.77)	200 (7.87)	NSYSFPSC20
Post mounting	45 (1.77)	300 (11.81)	NSYSFPSC30
Post mounting	45 (1.77)	400 (15.75)	NSYSFPSC40
Post mounting	45 (1.77)	500 (19.68)	NSYSFPSC50
Post mounting	45 (1.77)	600 (23.62)	NSYSFPSC60
Post mounting	45 (1.77)	800 (31.50)	NSYSFPSC80

Mounting lugs

- Wall-mounted lugs to be mounted directly on the rear of the box, either in horizontal or vertical position. Their versatile design complies with the mounting dimensions of many other enclosures.
- Ingress protection rating: IP66 according to IEC 60529
- Installation: Horizontal or vertical position, distance between wall and enclosure: 12 (0.47) mm (in.), only requires a screw driver
- Maximum load: 70 (154.32) kg (lbs.)

Supply:

4 wall-mounted lugs, screws and pre-mounted sealing gaskets



NSYAEFPFSB

Characteristics	References
Wall-mounted lugs	NSYAEFPFSB

Self-tapping screws

- Same reference for all enclosure dimensions
- Self-tapping, Pozidriv head, screws, for Ø 5 (0.20) mm (in.) holes.

Supply:

100 units



NSYAMFSB

Characteristics	References
Self-tapping screws	NSYAMFSB

Hinges

- The hinges allow the cover to be opened by more than 180°.
 - They can be installed on all covers of the range.
 - Ingress protection rating: IP66 according to IEC 60529
- Installation:**
- The box must be drilled before installing the 2 or 3 hinges on the body.
 - 3 hinges are required for boxes of width more than 500 (19.68) mm (in.)
 - A specific mark on the body helps to locate where the hole should be drilled
 - Maximum load: 30 (66.14) kg (lbs.)/m² on the hinged cover
 - Same reference for all enclosure dimensions

Supply:

Set of 6 hinges delivers with fixing hardware



NSYAEHHSB

Characteristics	References
Hinges SBM	NSYAEHHSB

Head screws

- The standard Pozidriv head screws can be replaced with the Double-bar or triangular shaped head screws, to discourage unauthorised opening of the cover with normal screwdrivers.
- Ingress protection rating: IP66 according to IEC 60529
- Installation: Simply replace the standard screw on the box
- Same reference for all enclosure dimensions

Supply:

1 unit



NSYAEBSBS

NSYAE DSTS

Characteristics	References
Double-bar shaped head 3 (0.12) mm (in.) screw	NSYAEBSBS
Triangular shaped head 6,5 (0.26) mm (in.) screw	NSYAE DSTS

Sealing kit

- The sealing kit helps to set up a lead-sealed cable of cover opening.
- Color: Green
- Ingress protection rating: IP66 according to IEC 60529
- Installation: Replaces the standard sealing washer on the box
- Same reference for all enclosure dimensions

Supply:

1 unit



NSYPPSB

Characteristics	References
Sealing kit SBM	NSYPPSB

Section A-A

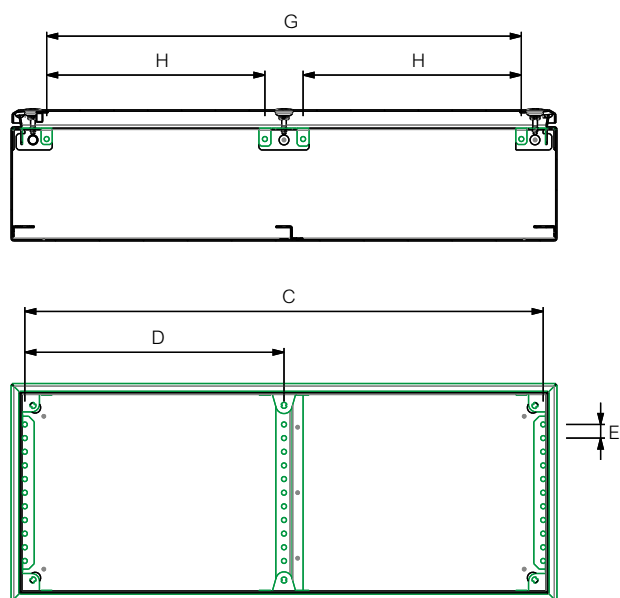

Section B-B

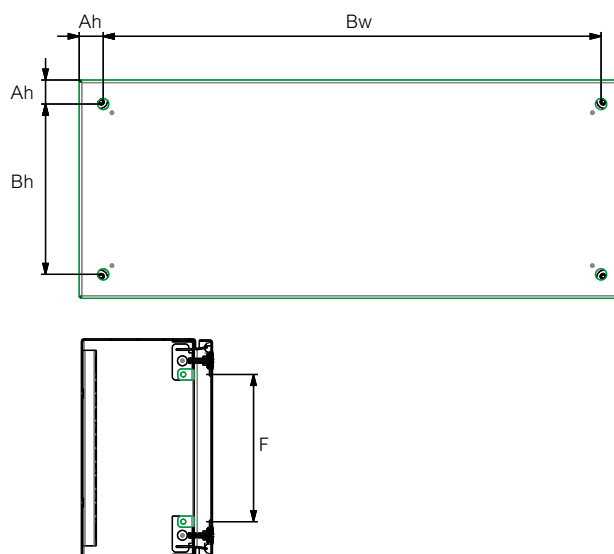

External mounting of the box and mounting accessories

Box mm (in.)		Mounting mm (in.)								
Height	Width	Ah	Bh	Bw	C	D	E	F	G	H
150 (5.91)	150 (5.91)	20.5 (0.81)	109 (4.29)	109 (4.29)	125 (4.92)	-	12.5 (0.49)	85 (3.35)	85 (3.35)	-
	200 (7.87)	20.5 (0.81)	109 (4.29)	159 (6.26)	175 (6.89)	-	12.5 (0.49)	85 (3.35)	135 (5.32)	-
	300 (11.81)	20.5 (0.81)	109 (4.29)	259 (10.20)	275 (10.83)	-	12.5 (0.49)	85 (3.35)	235 (9.25)	-
	400 (15.75)	20.5 (0.81)	109 (4.29)	359 (14.13)	375 (14.76)	-	12.5 (0.49)	85 (3.35)	335 (13.19)	-
200 (7.87)	200 (7.87)	20.5 (0.81)	159 (6.26)	159 (6.26)	175 (6.89)	-	12.5 (0.49)	135 (5.32)	135 (5.32)	-
	300 (11.81)	20.5 (0.81)	159 (6.26)	259 (10.20)	275 (10.83)	-	12.5 (0.49)	135 (5.32)	235 (9.25)	-
	400 (15.75)	20.5 (0.81)	159 (6.26)	359 (14.13)	375 (14.76)	-	12.5 (0.49)	135 (5.32)	335 (13.19)	-
	500 (19.68)	20.5 (0.81)	159 (6.26)	459 (18.07)	475 (18.70)	-	12.5 (0.49)	135 (5.32)	435 (17.13)	200 (7.87)
	600 (23.62)	20.5 (0.81)	159 (6.26)	559 (22.01)	575 (22.64)	-	12.5 (0.49)	135 (5.32)	535 (21.06)	250 (9.84)
	800 (31.50)	20.5 (0.81)	159 (6.26)	759 (29.88)	775 (30.51)	387.5 (15.26)	12.5 (0.49)	135 (5.32)	735 (28.94)	350 (13.78)
300 (11.81)	300 (11.81)	20.5 (0.81)	259 (10.20)	259 (10.20)	275 (10.83)	-	12.5 (0.49)	235 (9.25)	235 (9.25)	-
	400 (15.75)	20.5 (0.81)	259 (10.20)	359 (14.13)	375 (14.76)	-	12.5 (0.49)	235 (9.25)	335 (13.19)	-
	500 (19.68)	20.5 (0.81)	259 (10.20)	459 (18.07)	475 (18.70)	-	12.5 (0.49)	235 (9.25)	435 (17.13)	200 (7.87)
	600 (23.62)	20.5 (0.81)	259 (10.20)	559 (22.01)	575 (22.64)	-	12.5 (0.49)	235 (9.25)	535 (21.06)	250 (9.84)
400 (15.75)	800 (31.50)	20.5 (0.81)	259 (10.20)	759 (29.88)	775 (30.51)	387.5 (15.26)	12.5 (0.49)	235 (9.25)	735 (28.94)	350 (13.78)
	400 (15.75)	20.5 (0.81)	359 (14.13)	359 (14.13)	375 (14.76)	-	12.5 (0.49)	335 (13.19)	335 (13.19)	-
	500 (19.68)	20.5 (0.81)	359 (14.13)	459 (18.07)	475 (18.70)	-	12.5 (0.49)	335 (13.19)	435 (17.13)	200 (7.87)
	600 (23.62)	20.5 (0.81)	359 (14.13)	559 (22.01)	575 (22.64)	-	12.5 (0.49)	335 (13.19)	535 (21.06)	250 (9.84)
	800 (31.50)	20.5 (0.81)	359 (14.13)	759 (29.88)	775 (30.51)	387.5 (15.26)	12.5 (0.49)	335 (13.19)	735 (28.94)	350 (13.78)

Steel Wall-Mounted Enclosures

Spacial S3DC

Enclosure for indoor
non-clean industrial environment



Spacial CRN-CRNG

Enclosure for indoor
non-clean industrial environment



Spacial S3DC

Introduction	48
Characteristics	49
Protection	57
Selection Guide	58
Accessories	60
Cable Management	70
Dimensions	72

Spacial CRN-CRNG

Introduction*	74
Characteristics*	75
Selection Guide*	76
Accessories*	80
Dimensions*	91

Spacial® S3DC, CRN and CRNG

Steel enclosures

> Mounting & cabling systems

for setting up devices
and managing cabling

> Thermal management

for controlling the internal
temperature & humidity of
the enclosure



3 Material Solutions

Steel

Stainless-steel

Polyester

Time-saving & easy to equip

...with direct installation of the mounting plate.

Spacial S3DC, CRN and CRNG are designed to protect your equipment in most indoor installations with **harsh & dirty environments**, such as:

- Machines
- Manufacturing plants
- Logistics centers, etc

Whatever the installation environment, you can select the material according to your needs: steel, stainless-steel or polyester. Our enclosures share the same sizes and most of the mounting, cabling and installation accessories, to make selection and mounting simpler!

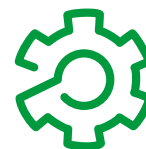

Machines



Industry

Spacial S3X

Stainless-steel enclosures



Durable & hygienic

...using highly corrosion-resistant material with a detailed finish, to reduce the risk of contamination.

Spacial S3X is commonly used in:

- **Food & beverage** and **pharmaceutical industries**, where the ability to clean hard water is required to help prevent the growth of bacteria.
- The **oil & gas** industries, for its chemical resistance.



Food & Beverage

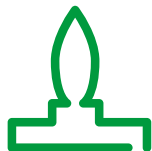

Oil & Gas

Thalassa™ PLM

Polyester enclosures



Safety & low maintenance

...thanks to its long-lasting and insulated material construction (Class II protection level from hazard).

Thalassa PLM offers excellent performance in:

- **Outdoor applications**, such as road & train infrastructures, airports and harbors, including saline environments.
- A good choice for harsh environments where non-corrosive materials are required.







Desalinization













Airport



Dimensions (mm and inches)					Spacial S3DC painted steel enclosures	Spacial S3X Stainless-steel 304L	Spacial S3XH Stainless-steel 316L
H mm (in.)	W mm (in.)	D mm (in.)	Doors	IP	Plain door without mounting plate	Plain door without mounting plate	Plain door without mounting plate
300 (11.81)	200 (7.87)	150 (5.91)	1	66	NSYS3DC3215	NSYS3X3215	NSYS3X3215H
300 (11.81)	300 (11.81)	150 (5.91)	1	66	NSYS3DC3315	NSYS3X3315	NSYS3X3315H
300 (11.81)	300 (11.81)	200 (7.87)	1	66	NSYS3DC3320	–	–
400 (15.75)	300 (11.81)	150 (5.91)	1	66	NSYS3DC4315	NSYS3X4315	NSYS3X4315H
400 (15.75)	300 (11.81)	200 (7.87)	1	66	NSYS3DC4320	NSYS3X4320	NSYS3X4320H
400 (15.75)	400 (15.75)	200 (7.87)	1	66	NSYS3DC4420	NSYS3X4420	NSYS3X4420H
500 (19.69)	400 (15.75)	200 (7.87)	1	66	NSYS3DC5420	NSYS3X5420	NSYS3X5420H
500 (19.69)	400 (15.75)	250 (9.84)	1	66	NSYS3DC5425	–	–
500 (19.69)	500 (19.69)	200 (7.87)	1	66	NSYS3DC5520	–	–
500 (19.69)	500 (19.69)	250 (9.84)	1	66	NSYS3DC5525	–	–
600 (23.62)	400 (15.75)	200 (7.87)	1	66	NSYS3DC6420	NSYS3X6420	NSYS3X6420H
600 (23.62)	400 (15.75)	250 (9.84)	1	66	NSYS3DC6425	–	–
600 (23.62)	600 (23.62)	200 (7.87)	1	66	NSYS3DC6620	–	–
600 (23.62)	600 (23.62)	250 (9.84)	1	66	NSYS3DC6625	NSYS3X6625	NSYS3X6625H
600 (23.62)	600 (23.62)	300 (11.81)	1	66	NSYS3DC6630	–	–
700 (27.56)	500 (19.69)	250 (9.84)	1	66	NSYS3DC7525	NSYS3X7525	NSYS3X7525H
800 (31.50)	600 (23.62)	200 (7.87)	1	66	NSYS3DC8620	–	–
800 (31.50)	600 (23.62)	250 (9.84)	1	66	NSYS3DC8625	NSYS3X8625	NSYS3X8625H
800 (31.50)	600 (23.62)	300 (11.81)	1	66	NSYS3DC8630	–	–
800 (31.50)	600 (23.62)	400 (15.75)	1	66	NSYS3DC8640	–	–
800 (31.50)	800 (31.50)	250 (9.84)	1	66	NSYS3DC8825	–	–
800 (31.50)	800 (31.50)	300 (11.81)	1	66	NSYS3DC8830	NSYS3X8830	NSYS3X8830H
1000 (39.37)	600 (23.62)	250 (9.84)	1	66	NSYS3D10625	–	–
1000 (39.37)	800 (31.50)	250 (9.84)	1	66	NSYS3DC10825	–	–
1000 (39.37)	800 (31.50)	300 (11.81)	1	66	NSYS3DC10830	NSYS3X10830	NSYS3X10830H
1000 (39.37)	800 (31.50)	400 (15.75)	1	66	NSYS3DC10840	–	–
1000 (39.37)	1000 (39.37)	300 (11.81)	1	66	NSYS3DC101030	–	–
1200 (47.24)	800 (31.50)	300 (11.81)	1	66	NSYS3DC12830	NSYS3X12830	NSYS3X12830H
1200 (47.24)	800 (31.50)	400 (15.75)	1	66	NSYS3DC12840	–	–
1200 (47.24)	1000 (39.37)	300 (11.81)	1	66	NSYS3DC121030	–	–





Wall-mounted bracket (x4)	References
 Steel	NSYAEFPFSC
 Stainless-steel	NSYPFCX
 Polyester	NSYPFPLM
Lighting	References
 Neon light, magnetic or mechanical mounting	NSYLAM75
 Door contact S3DC/S3X	NSYINLCRN





Mounting	References
 M6 nut for PLM direct mounting	NSYTCSPML
 Self-tapping screw for microperforated mounting plate	NSYS13M5HS
 Hexagonal screw M6 3 12 for alum. upright	NSYS12M6H
 Hexagonal screw M6 3 16 for alum. upright	NSYS16M6H
 Hexagonal screw M6 3 18 for alum. upright	NSYS18M6H
 M6 nut for alum. upright	NSYNM6

Thalassa PLM Polyester						
						
Plain door without mounting plate	Plain mounting plate painted white	Plain mounting plate galvanized	Microperforated mounting plate	Perforated (Telequick™) (1)	Aluminum upright (2)	
NSYPLM32	NSYMM32WH	NSYMM32	NSYMF32	NSYMR32	NSYMDVR3	
-	NSYMM33WH	NSYMM33	NSYMF33	NSYMR33	NSYMDVR3	
-	NSYMM33WH	NSYMM33	NSYMF33	NSYMR33	NSYMDVR3	
-	NSYMM43WH	NSYMM43	NSYMF43	NSYMR43	NSYMDVR4	
NSYPLM43	NSYMM43WH	NSYMM43	NSYMF43	NSYMR43	NSYMDVR4	
-	NSYMM44WH	NSYMM44	NSYMF44	NSYMR44	NSYMDVR4	
-	NSYMM54WH	NSYMM54	NSYMF54	NSYMR54	NSYMDVR5	
-	NSYMM54WH	NSYMM54	NSYMF54	NSYMR54	NSYMDVR5	
-	NSYMM55WH	NSYMM55	NSYMF55	NSYMR55	NSYMDVR5	
-	NSYMM55WH	NSYMM55	NSYMF55	NSYMR55	NSYMDVR5	
-	NSYMM64WH	NSYMM64	NSYMF64	NSYMR64	NSYMDVR6	
NSYPLM64	NSYMM64WH	NSYMM64	NSYMF64	NSYMR64	NSYMDVR6	
-	NSYMM66WH	NSYMM66	NSYMF66	NSYMR66	NSYMDVR6	
-	NSYMM66WH	NSYMM66	NSYMF66	NSYMR66	NSYMDVR6	
-	NSYMM66WH	NSYMM66	NSYMF66	NSYMR66	NSYMDVR6	
-	NSYMM66WH	NSYMM66	NSYMF66	NSYMR66	NSYMDVR6	
-	NSYMM75WH	NSYMM75	NSYMF75	NSYMR75	NSYMDVR7	
-	NSYMM86WH	NSYMM86	NSYMF86	NSYMR86	NSYMDVR8	
-	NSYMM86WH	NSYMM86	NSYMF86	NSYMR86	NSYMDVR8	
NSYPLM86	NSYMM86WH	NSYMM86	NSYMF86	NSYMR86	NSYMDVR8	
-	NSYMM86WH	NSYMM86	NSYMF86	NSYMR86	NSYMDVR8	
-	NSYMM88WH	NSYMM88	NSYMF88	NSYMR88	NSYMDVR8	
-	NSYMM88WH	NSYMM88	NSYMF88	NSYMR88	NSYMDVR8	
-	NSYMM106WH	NSYMM106	NSYMF106	NSYMR106	NSYMDVR10	
-	NSYMM108WH	NSYMM108	NSYMF108	NSYMR108	NSYMDVR10	
NSYPLM108	NSYMM108WH	NSYMM108	NSYMF108	NSYMR108	NSYMDVR10	
-	NSYMM108WH	NSYMM108	NSYMF108	NSYMR108	NSYMDVR10	
-	NSYMM1010WH	NSYMM1010	NSYMF1010	NSYMR1010	NSYMDVR10	
-	NSYMM128WH	NSYMM128	NSYMF128	NSYMR128	NSYMDVR12	
-	NSYMM128WH	NSYMM128	NSYMF128	NSYMR128	NSYMDVR12	
-	NSYMM1210WH	NSYMM1210	NSYMF1210	NSYMR1210	NSYMDVR12	

(1) NSYEMR is mandatory for Spacial S3DC enclosure width > 1000 (39.37) mm (in.).

(2) NSYAMCSF is mandatory for S3DC and S3X enclosures

Door accessories	References
 Door cable trunking support for Ø 22 mm / 0.86 in (310)	NSYSPCP
 Plastic document pocket A4, d = 20 (0.79) mm (in.)	NSYDPA4
 Plastic document pocket A4, d = 40 (1.58) mm (in.)	NSYDPA44
 Plastic window 248 3 235 3 13	NSYVA2736M
 Plastic window 78 3 95 3 15	NSYVA274M

Grounding	References
 Grounding lead 160, sec. 6²	NSYEL166D8
 Grounding lead L350, sec. 25²	NSYEL3525D8
 Grounding strip connection points 87	NSYECB1M153
 2 grounding collector supports	NSYEDCOS
 2 grounding collector rail supports	NSYEDCOC

Locking system	References
 Screwdriver insert for Thalassa PLM	NSYAE LSD

Technical changes reserved. Information provided without guarantee. Images are for illustrative purposes only.

Spacial S3DC: The multipurpose enclosure



Automation

Network and Electronics



S3HF

You need an efficient sealed enclosure for an industrial facility with EMC constraints. Our solution: the offer for EMC environments. Enclosures suited to different EMC environments.

- IP55 water and dust tightness
- See [page 380](#).



S3DC

You need an efficient, sealed multipurpose and aesthetic enclosure for an indoor industrial facility. Our solution: the Spacial S3DC universal offer.

A universal enclosure with 3-point locks and a broad range of accessories to conform to all your applications.

- NEMA 4, 4X, IP66 water and dust tightness.
- A complete offer of 30 dimensions from 300 x 200 x 150 mm (11.8 x 7.9 x 5.9 in.) to 1200 x 1000 x 300 mm (47.2 x 39.4 x 11.8 in.):
 - With plain door, without cable-gland plate
 - Resistance to mechanical impacts:
 - IK10 plain door
 - Compliance with enclosure standard EN 62208 and IEC 62208
 - A broad range of accessories to conform to all your applications
 - See the Selection Guide on [page 58](#).

Features

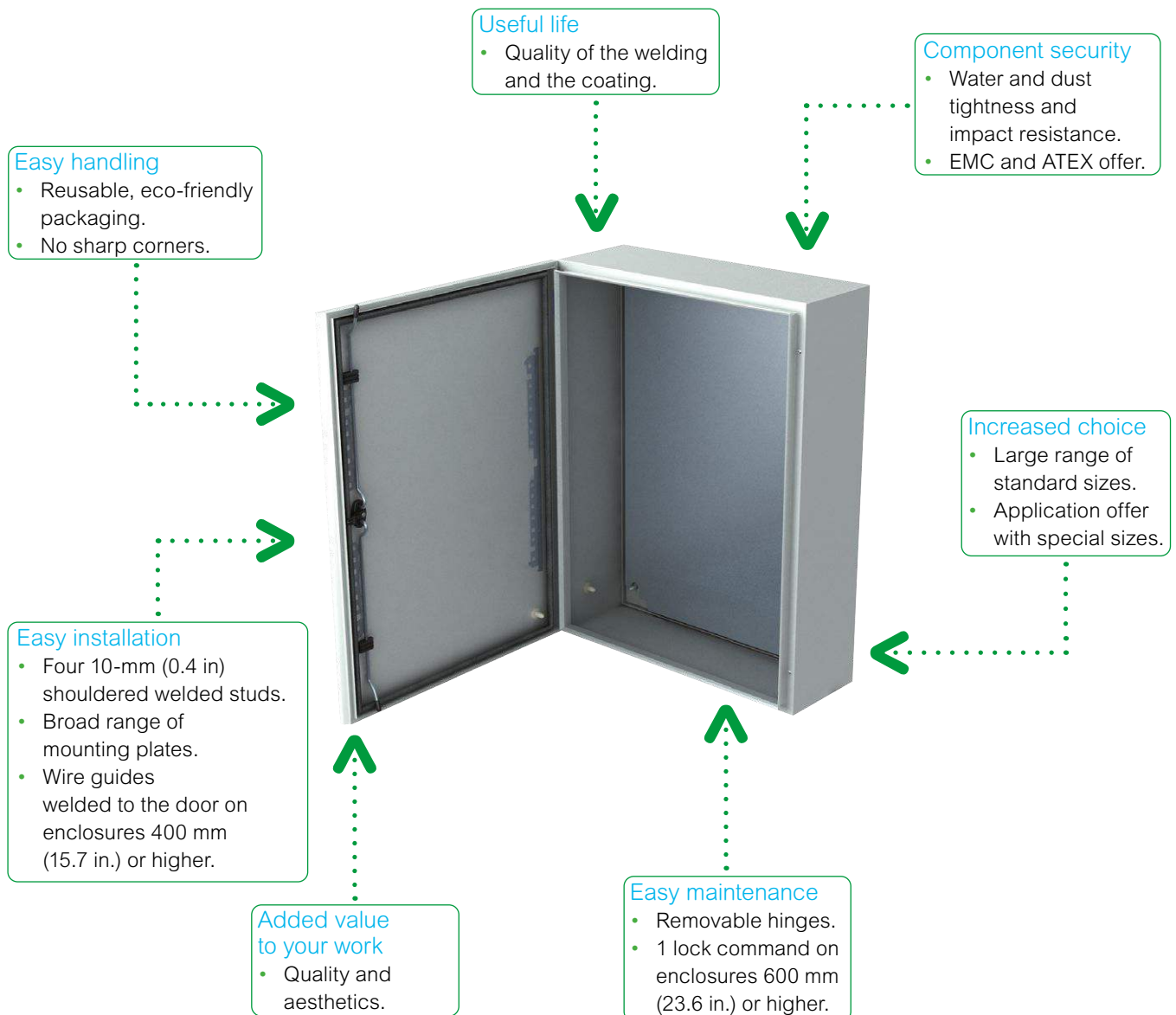



> Mounting

> Cable installation and management

① Wall-mounted

⑤ Installation

② Floor-standing

⑥ Cable entries

③ Roof

⑦ Cable management

④ Viewing and grounding

⑧ Thermal management

The Spacial S3DC steel enclosure universal offer

- Enclosure with plain door.
- Structured finish, epoxy-polyester powder, RAL 7035 gray color.
See the Selection Guide on [page 58](#).

Technical characteristics

Enclosure body

- Single-piece body (cross-shaped structure).
Gutter-shaped front profile with double fold. Flat rear.
- 4 (or 6**) M8 x 25 shouldered backstuds for installing mounting plates and step slides, leaving a space of 10 mm (0.4 in.) behind them.
- M6 x 16 grounding studs for equipotential connection between the door and the body of the enclosure.
- Four direct wall-mounted drill holes [Ø 10 mm (0.4 in.)] are sealed with plugs to maintain the degree of protection. Or mount with lugs installed from the outside (lugs ordered separately, see [page 64](#)).

Enclosure door

- Wall-mounted enclosure supplied with screwdriver insert lock as standard.
- Polyurethane door gasket.
- M6 x 16 grounding studs for equipotential connection between the door and the body of the enclosure.
- Easily removable and reversible, with 20-mm (0.8 in.) return with double thickness for excellent rigidity, opening to 120°, equipped with 2 or 3 invisible hinges*.
- For heights from 600 mm (23.6 in.), three locking points with linkage, with a single control point. Simple reversal of linkage. Maximum load: 50 (110.23) kg (lbs.) /m².
- Perforated rails on the door, with pre-drilled holes with a diameter of 4.2 mm (0.2 in.) in steps of 25 mm (1.0 in.):
– 2 vertical rails from the height of 400 mm (15.7 in.),
– 2 vertical rails and 2 horizontal rails from the width of 800 mm (31.5 in.).

* From the height of 800 mm (31.5 in.).

** Widths of 1000 and 1200 mm (39.4 and 47.2 in.).

Standards

Compliance with enclosure standards IEC 62208, UL 508A.

Environmental testing to UL 50E.

The Spacial S3DC wall-mounted enclosures are compliant with the RoHS directive.

Certifications

For certification table, see [page 506](#).



3-point lock enclosure.



One action point enclosure.



Welded studs for the ground connection.



Screwdriver lock
(coin protected).

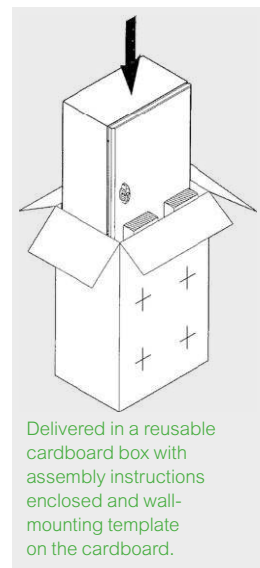

Delivered in a reusable cardboard box with assembly instructions enclosed and wall-mounting template on the cardboard.

Note:

Our certificates can be downloaded from our website.

Our empty enclosures are marked CE according to the Low-Voltage Directive (LVD). It is the responsibility of the final equipment manufacturer to respect the regulations in force.

Technical characteristics

Protection degree

- IP66 for the single-door enclosures and IP55 for the double-door enclosures, according to IEC 60529.
- UL/NEMA rated 4, 4X for the single-door enclosures and 12, 12K, 13 for the double-door enclosures according to UL 50E and NEMA 250.

Resistance to external mechanical impacts

- IK10 for the plain-door enclosures, according to IEC 62262.
- IK08 for the glazed-door enclosures.

Mechanical characteristics

Attachment of mounting hardware

- 4 (or 6**) M8 3 25 shouldered backstuds for installing mounting plates and step slides, leaving a space of 10 mm (0.4 in.) behind them.

** 6 studs for widths 1000 and 1200 mm (39.4 and 47.2 in.).

Personnel protection

Ground connection: Spacial S3DC steel enclosures are equipped with M6 x 16 grounding studs welded in the body and the door for equipotential connection. Grounding braid ordered separately (see [page 303](#)).

Closing the enclosure: enclosures of 600 mm (23.6 in.) and higher are equipped with three linked locking points, with a single control point, preventing the enclosures from being left ajar. For locks and inserts see [page 67](#).

Coating properties

Color: RAL 7035 gray; finish: structured.

Coating thickness: 60 µm.

Fire class: M0.

Resistance to corrosion: compliance with standard IEC 62208 for outdoor installation: 288 h of humid heat and 336 h of salt mist.

Note: the Spacial S3DC is specially designed for indoor installations. For outdoor installations, it is advisable to install a canopy or contact us.

Protection from nuclear contamination (NFT 30901): RAL 7035 and AFNOR A550 tests available on request.

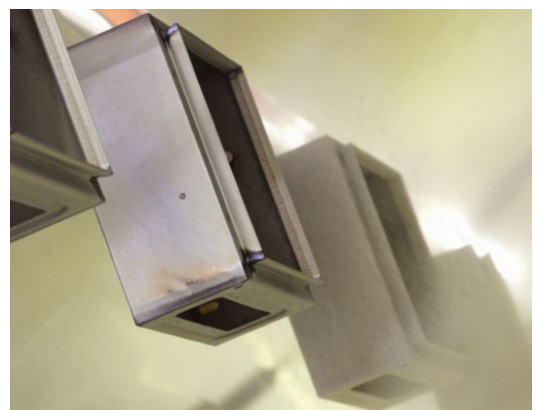
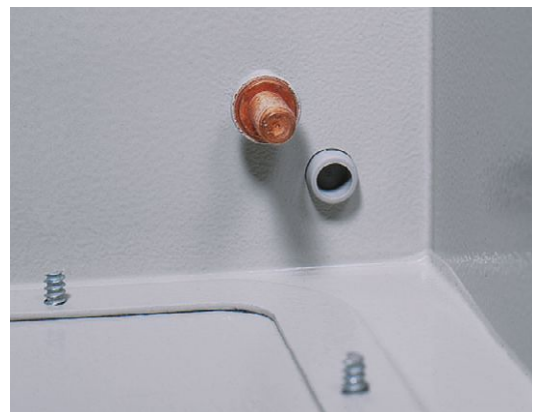

Note:

For further information see the technical annexes on [page 506](#).

EMC protection

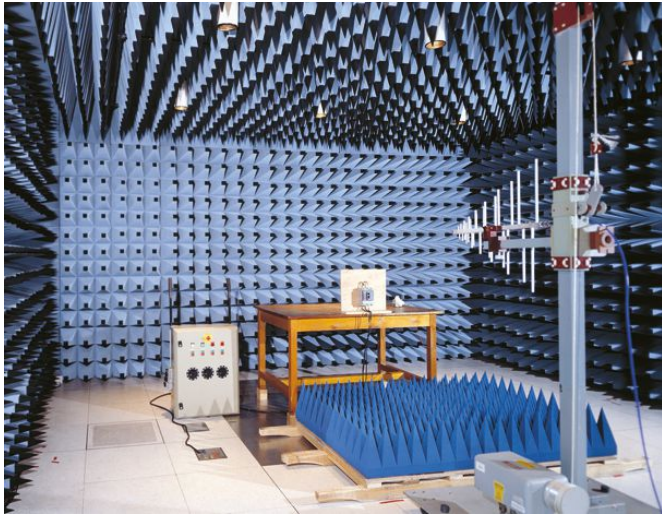

Standard Spacial S3DC enclosures are tested against electromagnetic interference. Since the enclosure is tested empty, it is advisable to rerun the tests with the enclosure equipped in its final configuration.

Grounding braids ordered separately, see [page 303](#).

For another EMC solution and additional information on electromagnetic compatibility, see the Spacial S3HF enclosure, [page 382](#).

Attenuation curve of the Spacial S3DC compared with the Spacial S3HF

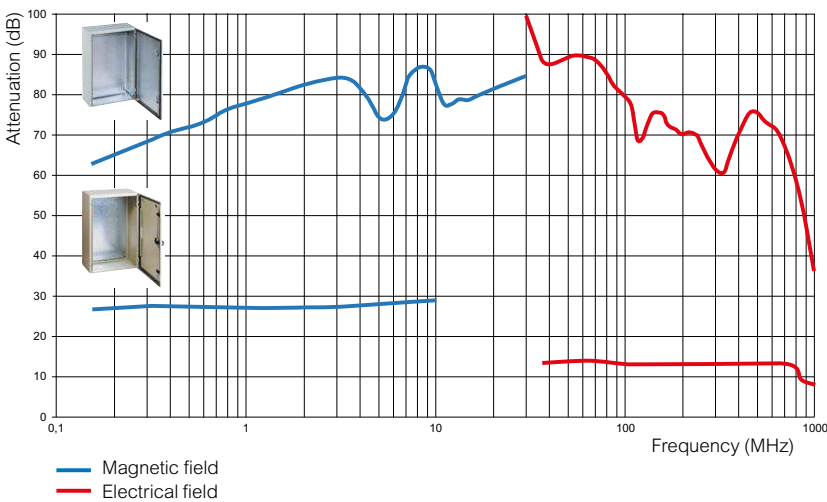

Frequency: 3 - 13.2 Hz
 Amplitude: 1 (0.04) mm (in.)/sec below 22 Hz
 Frequency: 3 - 100 Hz
 Acceleration: 0.7 g above 30 Hz

Vibration constraints

The Spacial S3DC enclosure is constructed as a single-piece body with a crossshaped structure. The rear is flat without added parts, allowing it to comply with specific vibration constraints. The tests were conducted according to the "rules for ships" by "Det Norske Veritas." Enclosures labelled "DNV" have undergone these tests and obtained classification "A." Since the enclosure is tested empty, it is advisable to rerun the tests with the enclosure equipped in its final configuration.

ATEX compliance

The Spacial S3DC enclosure (with adaptation) is ATEX-certified by the LCIE.

Environmental properties





Compliance with RoHS standard.





Plain front door



Dimensions (mm and inches)			Doors	IP	Weight of empty enclosures: kg (lbs)	Without mounting plate	Plain mounting plate painted white	Plain mounting plate galvanized
H mm (in.)	W mm (in.)	D mm (in.)						
300 (11.81)	200 (7.87)	150 (5.91)	1	66	2.82 (6.2)	NSYS3DC3215	NSYMM32WH	NSYMM32
300 (11.81)	300 (11.81)	150 (5.91)	1	66	3.18 (7.0)	NSYS3DC3315	NSYMM33WH	NSYMM33
300 (11.81)	300 (11.81)	200 (7.87)	1	66	4.07 (9.0)	NSYS3DC3320	NSYMM33WH	NSYMM33
400 (15.75)	300 (11.81)	150 (5.91)	1	66	4.66 (10.3)	NSYS3DC4315	NSYMM43WH	NSYMM43
400 (15.75)	300 (11.81)	200 (7.87)	1	66	4.57 (10.1)	NSYS3DC4320	NSYMM43WH	NSYMM43
400 (15.75)	400 (15.75)	200 (7.87)	1	66	5.92 (13.1)	NSYS3DC4420	NSYMM44WH	NSYMM44
500 (19.69)	400 (15.75)	200 (7.87)	1	66	8.72 (19.2)	NSYS3DC5420	NSYMM54WH	NSYMM54
500 (19.69)	400 (15.75)	250 (9.84)	1	66	9.62 (21.2)	NSYS3DC5425	NSYMM54WH	NSYMM54
500 (19.69)	500 (19.69)	200 (7.87)	1	66	10.41 (23.0)	NSYS3DC5520	NSYMM55WH	NSYMM55
500 (19.69)	500 (19.69)	250 (9.84)	1	66	11.29 (24.9)	NSYS3DC5525	NSYMM55WH	NSYMM55
600 (23.62)	400 (15.75)	200 (7.87)	1	66	10.11 (22.3)	NSYS3DC6420	NSYMM64WH	NSYMM64
600 (23.62)	400 (15.75)	250 (9.84)	1	66	11.42 (25.2)	NSYS3DC6425	NSYMM64WH	NSYMM64
600 (23.62)	600 (23.62)	200 (7.87)	1	66	13.11 (28.9)	NSYS3DC6620	NSYMM66WH	NSYMM66
600 (23.62)	600 (23.62)	250 (9.84)	1	66	14.11 (31.1)	NSYS3DC6625	NSYMM66WH	NSYMM66
600 (23.62)	600 (23.62)	300 (11.81)	1	66	15.59 (34.4)	NSYS3DC6630	NSYMM66WH	NSYMM66
700 (27.56)	500 (19.69)	250 (9.84)	1	66	14.23 (31.4)	NSYS3DC7525	NSYMM75WH	NSYMM75
800 (31.50)	600 (23.62)	200 (7.87)	1	66	20.11 (44.3)	NSYS3DC8620	NSYMM86WH	NSYMM86
800 (31.50)	600 (23.62)	250 (9.84)	1	66	22.11 (48.7)	NSYS3DC8625	NSYMM86WH	NSYMM86
800 (31.50)	600 (23.62)	300 (11.81)	1	66	23.59 (52.0)	NSYS3DC8630	NSYMM86WH	NSYMM86
800 (31.50)	600 (23.62)	400 (15.75)	1	66	27.59 (60.8)	NSYS3DC8640	NSYMM86WH	NSYMM86
800 (31.50)	800 (31.50)	250 (9.84)	1	66	29.42 (64.9)	NSYS3DC8825	NSYMM88WH	NSYMM88
800 (31.50)	800 (31.50)	300 (11.81)	1	66	31.42 (69.3)	NSYS3DC8830	NSYMM88WH	NSYMM88
1000 (39.37)	600 (23.62)	250 (9.84)	1	66	27.11 (59.8)	NSYS3DC10625	NSYMM106WH	NSYMM106
1000 (39.37)	800 (31.50)	250 (9.84)	1	66	33.84 (74.6)	NSYS3DC10825	NSYMM108WH	NSYMM108
1000 (39.37)	800 (31.50)	300 (11.81)	1	66	36.84 (81.2)	NSYS3DC10830	NSYMM108WH	NSYMM108
1000 (39.37)	800 (31.50)	400 (15.75)	1	66	40.84 (90.0)	NSYS3DC10840	NSYMM108WH	NSYMM108
1000 (39.37)	1000 (39.37)	300 (11.81)	1	66	44.46 (98.0)	NSYS3DC101030	NSYMM1010WH	NSYMM1010
1200 (47.24)	800 (31.50)	300 (11.81)	1	66	43.84 (96.7)	NSYS3DC12830	NSYMM128WH	NSYMM128
1200 (47.24)	800 (31.50)	400 (15.75)	1	66	47.84 (105.5)	NSYS3DC12840	NSYMM128WH	NSYMM128
1200 (47.24)	1000 (39.37)	300 (11.81)	1	66	51.46 (113.4)	NSYS3DC121030	NSYMM1210WH	NSYMM1210

Installation accessories	References
 Set of 4 steel mounting lugs	NSYAEFFPFC
 Set of 4 stainless-steel mounting lugs	NSYAEFFFXSC
 Kit for heavy loads	NSYAEFAHLBSC
 Set of 2 M8 eyebolts	NSYAELYTCRG8

Door accessories	References
 Steel door retainer for S3DC steel enclosure	NSYAEDRSCST
 Door switch for wall-mounted enclosures	NSYINLCRN
 Grounding lead 160, sec. 6 mm ²	NSYEL166D8





See also these accessories

Equipment mounting plate
Page 62Accessories for mounting plate
Page 62Cable-management accessories
Page 70

Mounting plate					Accessories				
Microperforated mounting plate galvanized	Aluminum upright *	Perforated Telequick **	19" fixed chassis	19" pivoting chassis	Internal door	Adjustable brackets	Door cross-rail	Canopy	
NSYMF32	NSYMDVR3	NSYMR32	-	-	-	-	-	NSYTJ2015	
NSYMF33	NSYMDVR3	NSYMR33	-	-	-	-	-	NSYTJ3015	
NSYMF33	NSYMDVR3	NSYMR33	-	-	-	NSYSDCR200	-	NSYTJ3020	
NSYMF43	NSYMDVR4	NSYMR43	-	-	NSYPIN43	-	-	NSYTJ3015	
NSYMF43	NSYMDVR4	NSYMR43	-	-	NSYPIN43	NSYSDCR200	-	NSYTJ3020	
NSYMF44	NSYMDVR4	NSYMR44	-	-	-	NSYSDCR200	NSYTFPCR4	NSYTJ4020	
NSYMF54	NSYMDVR5	NSYMR54	-	-	NSYPIN54	NSYSDCR200	NSYTFPCR4	NSYTJ4020	
NSYMF54	NSYMDVR5	NSYMR54	-	-	NSYPIN54	NSYSDCR250	NSYTFPCR4	NSYTJ4025	
NSYMF55	NSYMDVR5	NSYMR55	-	-	-	NSYSDCR200	NSYTFPCR5	NSYTJ5020	
NSYMF55	NSYMDVR5	NSYMR55	-	-	-	NSYSDCR250	NSYTFPCR5	NSYTJ5025	
NSYMF64	NSYMDVR6	NSYMR64	-	-	NSYPIN64	NSYSDCR200	NSYTFPCR4	NSYTJ4020	
NSYMF64	NSYMDVR6	NSYMR64	-	-	NSYPIN64	NSYSDCR250	NSYTFPCR4	NSYTJ4025	
NSYMF66	NSYMDVR6	NSYMR66	NSYVDM12UF	NSYVDM11UP	-	NSYSDCR200	NSYTFPCR6	NSYTJ6020	
NSYMF66	NSYMDVR6	NSYMR66	NSYVDM12UF	NSYVDM11UP	-	NSYSDCR250	NSYTFPCR6	NSYTJ6025	
NSYMF66	NSYMDVR6	NSYMR66	NSYVDM12UF	NSYVDM11UP	-	NSYSDCR300	NSYTFPCR6	NSYTJ6030	
NSYMF75	NSYMDVR7	NSYMR75	-	-	NSYPIN75	NSYSDCR250	NSYTFPCR5	NSYTJ5025	
NSYMF86	NSYMDVR8	NSYMR86	NSYVDM17UF	NSYVDM16UP	NSYPIN86	NSYSDCR200	NSYTFPCR6	NSYTJ6020	
NSYMF86	NSYMDVR8	NSYMR86	NSYVDM17UF	NSYVDM16UP	NSYPIN86	NSYSDCR250	NSYTFPCR6	NSYTJ6025	
NSYMF86	NSYMDVR8	NSYMR86	NSYVDM17UF	NSYVDM16UP	NSYPIN86	NSYSDCR300	NSYTFPCR6	NSYTJ6030	
NSYMF86	NSYMDVR8	NSYMR86	NSYVDM17UF	NSYVDM16UP	NSYPIN86	NSYSDCR400	NSYTFPCR6	NSYTJ6040	
NSYMF88	NSYMDVR8	NSYMR88	-	-	-	NSYSDCR250	NSYTFPCR8	NSYTJ8025	
NSYMF88	NSYMDVR8	NSYMR88	-	-	-	NSYSDCR300	NSYTFPCR8	NSYTJ8030	
NSYMF106	NSYMDVR10	NSYMR106	NSYVDM21UF	NSYVDM20UP	NSYPIN106	NSYSDCR250	NSYTFPCR6	NSYTJ6025	
NSYMF108	NSYMDVR10	NSYMR108	-	NSYVDM20U8P	NSYPIN108	NSYSDCR250	NSYTFPCR8	NSYTJ8025	
NSYMF108	NSYMDVR10	NSYMR108	-	NSYVDM20U8P	NSYPIN108	NSYSDCR300	NSYTFPCR8	NSYTJ8030	
NSYMF108	NSYMDVR10	NSYMR108	-	NSYVDM20U8P	NSYPIN108	NSYSDCR400	NSYTFPCR8	NSYTJ8040	
NSYMF1010	NSYMDVR10	NSYMR1010	-	-	-	NSYSDCR300	NSYTFPCR10	NSYTJ10030	
NSYMF128	NSYMDVR12	NSYMR128	-	NSYVDM25U8P	NSYPIN128	NSYSDCR300	NSYTFPCR8	NSYTJ8030	
NSYMF128	NSYMDVR12	NSYMR128	-	NSYVDM25U8P	NSYPIN128	NSYSDCR400	NSYTFPCR8	NSYTJ8040	
NSYMF1210	NSYMDVR12	NSYMR1210	-	-	-	NSYSDCR300	NSYTFPCR10	NSYTJ10030	

⁽¹⁾ NSYEMR mandatory.

⁽²⁾ NSYAMCSF mandatory for enclosure width > 1000.

Mounting	References
 <p>Mounting for the grounding strip</p>	NSYEDCOS
 <p>Self-tapping screw for microperforated mounting plate</p>	NSYS13M5HS

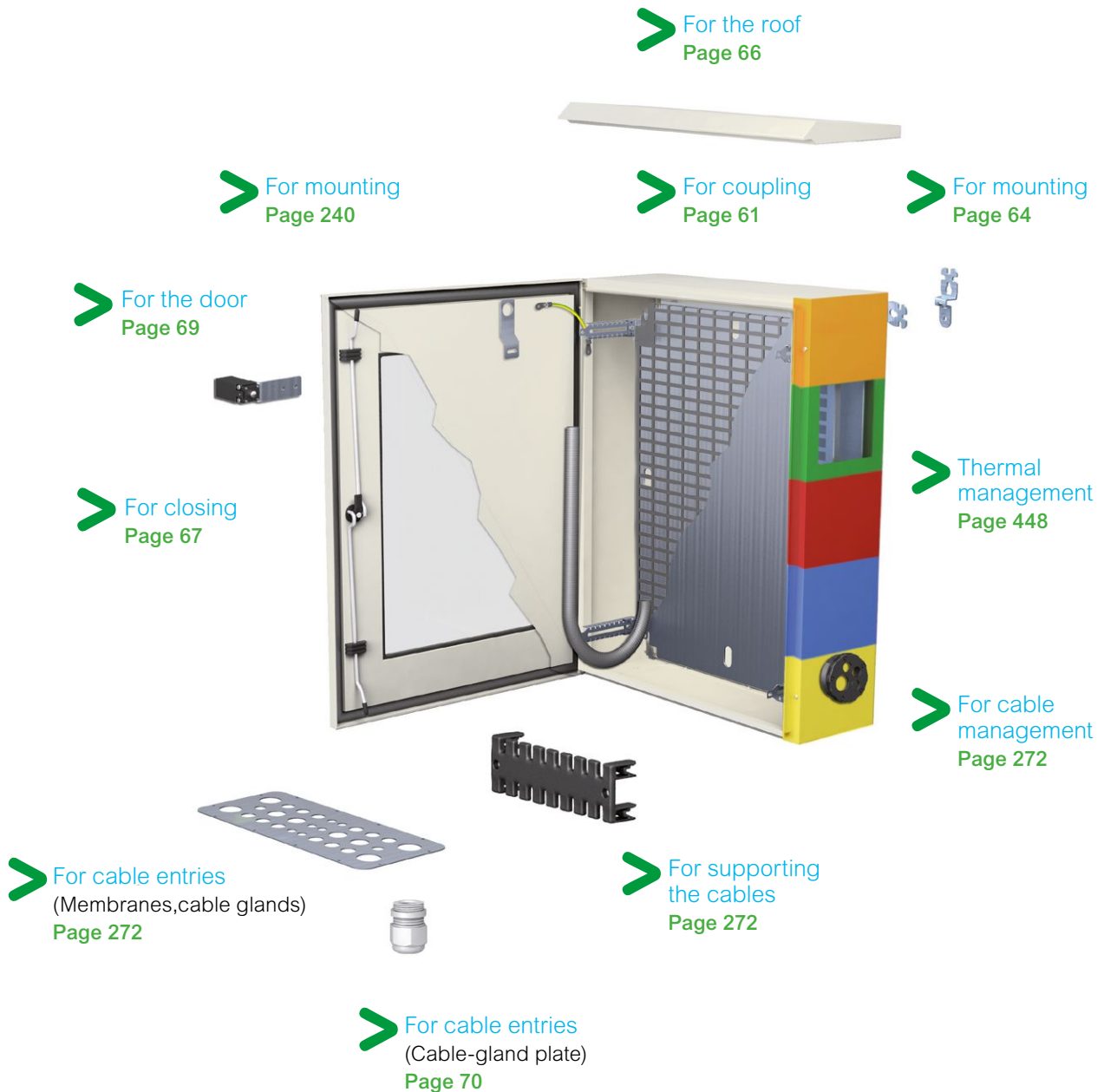

See also these accessories

Mounting plate
Page 240

DIN rail and mountings
Page 244

Coupling Spacial steel enclosures

- Available in 2 versions:
Coupling version without cable entry.
Version with coupling frame allowing the entry of cables.
- Separation of 17 mm (0.7 in.) between 2 coupled enclosures, allowing full opening of the doors.

Coupling frame

- Allows lateral coupling of 2 enclosures.
- The frame is made of polyester charged with self-extinguishing fiberglass.
- A built-in sealing gasket helps ensure the IP66 degree of protection.
- Mounting by screws, included.
- Dimensions: 435 x 185 mm (17.1 x 7.3 in.) and 635 x 185 mm (25.0 x 7.3 in.).
- These frames allow the door to open to 120°.

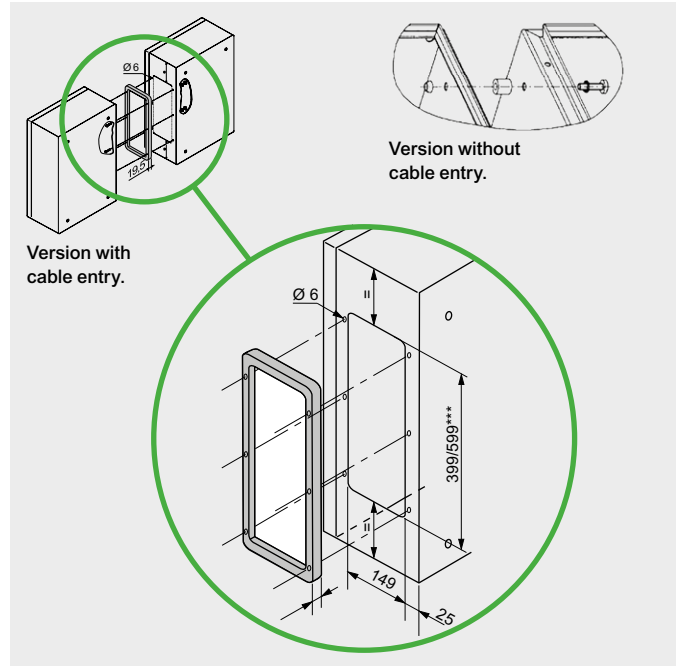

Supply:
The kit consists of 4 spacers and hardware.

Coupling spacers



NSYAEUBUSC

Characteristics	References
Set of 4 coupling spacers	NSYAEUBUSC

Coupling frame



NSYAEUBU41SC

Characteristics	References
Coupling frame, 435 x 185 mm (17.1 x 7.3 in.)	NSYAEUBU41SC
Coupling frame, 635 x 185 mm (25.0 x 7.3 in.)	NSYAEUBU61SC

Installation of Telequick mounting plates

Spacers for raising the mounting plate in the enclosures equipped with 6 studs (enclosure widths ≥ 1000 mm [39.4 in]).

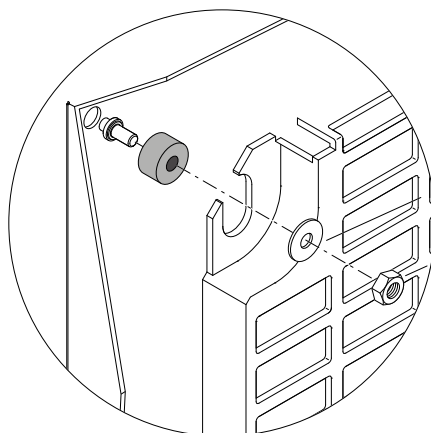
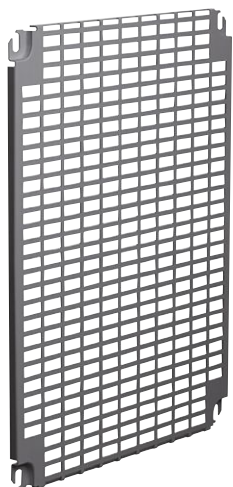

Reference NSYEMR

Advantages of Telequick mounting solution

- No more drawing on the mounting plate.
- No more machining of the mounting plate.



Direct mounting of equipment on nuts.



Accessories designed for cable management.

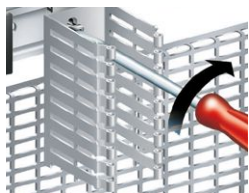

Mount your cable duct easily.



Allows accessories to be clipped on.

Wall-mounted lugs

- Set of 4 wall-mounted lugs
- Mounted directly on the rear of the enclosure, either in horizontal or vertical position.
- Available in two materials, steel and 304L stainless-steel. Can be mounted in two positions, vertical or horizontal, for a wall enclosure separation of 10 mm (0.4 in.).
- Acceptable load:
 - Horizontal lug: 180 kg (396.8 lbs).
 - Vertical lug: 350 kg (771.6 lbs).

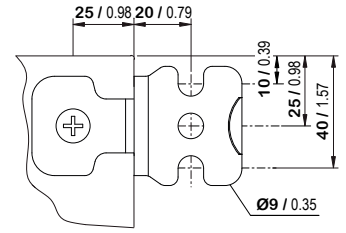

S3DC Wall-fixing lugs for Spacial CRNG enclosures



- Material: steel

Characteristics	References
Set of 4 steel mounting lugs	NSYAEFFPFS3C

S3DC Wall-fixing lugs for Spacial CRNG enclosures



- Material: Stainless-steel

Characteristics	References
Set of 4 stainless-steel mounting lugs	NSYAEFFPFX3C

Supply:
Supplied with mounting screws and pre-mounted sealing gaskets.

S3DC Kit for heavy loads



- Kit made up of 2 steel reinforcement pieces.
- Maximum load: 400 kg (881.8 lbs).
- To be mounted before installing the mounting plate in top position with the standard lugs (ordered separately).

Characteristics	References
Kit for heavy load	NSYAEFAHLB3C

Supply:
Kit composed with 2 brackets

Full-width mounting lugs

- Kit consists of 2 parts (top and bottom).
- Made from passivated zinc-coated steel.
- Mounted with screws from the inside.
- Permissible load: 350 kg (771.6 lbs).

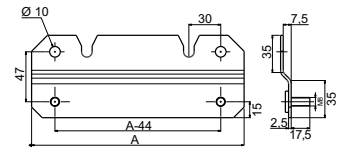

Characteristics	Width: mm (in.)	A mm (in.)	References
Heavy load reinforcement	200 (7.9)	-	NSYAEFFPFS3DW20
Heavy load reinforcement	300 (11.8)	295 (11.61)	NSYAEFFPFS3DW30
Heavy load reinforcement	400 (15.7)	395 (15.55)	NSYAEFFPFS3DW40
Heavy load reinforcement	500 (19.7)	495 (19.49)	NSYAEFFPFS3DW50
Heavy load reinforcement	600 (23.6)	595 (23.42)	NSYAEFFPFS3DW60
Heavy load reinforcement	800 (31.5)	795 (31.30)	NSYAEFFPFS3DW80
Heavy load reinforcement	1000 (39.4)	-	NSYAEFFPFS3DW100

Post-mounting device for Spacial steel enclosure

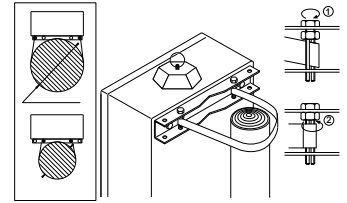
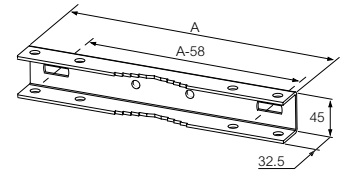

Supply:
2 pieces

- For indoor installations on posts with a maximum circumference of 675 mm (26.6 in.) [min. diameter 150 mm (5.9 in.) and max. diameter 215 mm (8.5 in.).
For indoor installations on posts with a maximum circumference of 675 mm (26.6 in.) [min. diameter 150 mm (5.9 in.) and max. diameter 215 mm (8.5 in.).]
- Material: galvanized steel.
- Rail fixed to the inserts in the rear of the enclosure with 8-mm (0.3 in.) screws.
- Maximum load: 100 kg (220.5 lbs).
- They allow the mounting of protection canopies.
- For steel enclosures with widths of 300, 400, 500, 600 and 800 mm (11.8, 15.7, 19.7, 23.6 and 31.5 in.).



NSYSFPSC30

Characteristics	A: mm (in.)	References
Post-mounting for enclosure with W 300 mm (11.8 in.)	295 (11.6)	NSYSFPSC30
Post-mounting for enclosure with W 400 mm (15.7 in.)	395 (15.6)	NSYSFPSC40
Post-mounting for enclosure with W 500 mm (19.7 in.)	495 (19.5)	NSYSFPSC50
Post-mounting for enclosure with W 600 mm (23.6 in.)	595 (23.4)	NSYSFPSC60
Post-mounting for enclosure with W 800 mm (31.5 in.)	795 (31.3)	NSYSFPSC80

Floor stand kit for wall-mounted enclosure

- Set of 2 legs, for elevation of wall-mounted enclosures.
- Mounting holes that match the holes of the existing structure.
- Made of galvanized steel: thickness 2.5 mm (0.09 in.) for sides and 3 mm (0.11 in.) for the base.
- Coating: RAL 7035 gray polyester powder finish.
- Maximum load: 1300 kg (2866.0 lbs).

Supply:
2 platform legs (right and left)
and mounting hardware.



NSYWWMK33

Characteristics	Enclosure depth mm (in.)	Legs height mm (in.)	References
Floor stand for Spacial S3D	300 (11.8)	300 (11.8)	NSYWWMK33
Floor stand for Spacial S3D	400 (15.7)	300 (11.8)	NSYWWMK43
Floor stand for Spacial S3D	300 (11.8)	450 (17.7)	NSYWWMK34
Floor stand for Spacial S3D	400 (15.7)	450 (17.7)	NSYWWMK44

Eyebolts



NSYAELYTCRG8

- Set of two M8 eyebolts.
- Material: zinc-coated molded steel.
- The eyebolts are mounted directly to the body of the enclosure.
- Maximum load: 210 kg (463.0 lbs) per enclosure with the sling at 60°.
- Cannot be installed with the canopy in place.

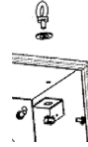

Supply:
The reinforcing brackets are attached to the rings.
The reinforcing brackets also act as a drilling template.

Characteristics	References
Set of 2 M8 eyebolts	NSYAELYTCRG8

Protection canopy



NSYTJ2015

- Direct mounting to the body of the enclosure by 4 M6 screws.
- Material: painted galvanized steel, structured finish, epoxy-polyester powder, RAL 7035 gray color.

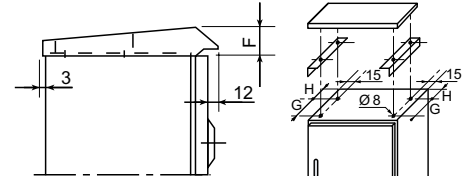

Supply:
Delivered with installation hardware.
To be used for all outdoor installations.

Characteristics	Width mm (in.)	Depth mm (in.)	F mm (in.)	G mm (in.)	H mm (in.)	References
Protection canopy	200 (7.9)	150 (5.9)	36 (1.4)	75 (3.0)	23 (0.9)	NSYTJ2015
Protection canopy	250 (9.8)	150 (5.9)	36 (1.4)	75 (3.0)	23 (0.9)	NSYTJ2515
Protection canopy	300 (11.8)	150 (5.9)	36 (1.4)	75 (3.0)	23 (0.9)	NSYTJ3015
Protection canopy	400 (15.7)	150 (5.9)	36 (1.4)	75 (3.0)	23 (0.9)	NSYTJ4015
Protection canopy	500 (19.7)	150 (5.9)	36 (1.4)	75 (3.0)	23 (0.9)	NSYTJ5015
Protection canopy	500 (19.7)	200 (7.9)	36 (1.4)	130 (5.1)	23 (0.9)	NSYTJ5020
Protection canopy	600 (23.6)	200 (7.9)	36 (1.4)	130 (5.1)	23 (0.9)	NSYTJ6020
Protection canopy	250 (9.8)	200 (7.9)	36 (1.4)	130 (5.1)	23 (0.9)	NSYTJ2520
Protection canopy	300 (11.8)	200 (7.9)	36 (1.4)	130 (5.1)	23 (0.9)	NSYTJ3020
Protection canopy	400 (15.7)	200 (7.9)	36 (1.4)	130 (5.1)	23 (0.9)	NSYTJ4020
Protection canopy	800 (31.5)	200 (7.9)	36 (1.4)	130 (5.1)	23 (0.9)	NSYTJ8020
Protection canopy	400 (15.7)	250 (9.8)	42 (1.7)	150 (5.9)	48 (1.9)	NSYTJ4025
Protection canopy	500 (19.7)	250 (9.8)	42 (1.7)	150 (5.9)	48 (1.9)	NSYTJ5025
Protection canopy	600 (23.6)	250 (9.8)	42 (1.7)	150 (5.9)	48 (1.9)	NSYTJ6025
Protection canopy	800 (31.5)	250 (9.8)	42 (1.7)	150 (5.9)	48 (1.9)	NSYTJ8025
Protection canopy	600 (23.6)	300 (11.8)	42 (1.7)	200 (7.9)	48 (1.9)	NSYTJ6030
Protection canopy	800 (31.5)	300 (11.8)	42 (1.7)	200 (7.9)	48 (1.9)	NSYTJ8030
Protection canopy	1000 (39.4)	300 (11.8)	42 (1.7)	200 (7.9)	48 (1.9)	NSYTJ10030
Protection canopy	1200 (47.2)	300 (11.8)	42 (1.7)	200 (7.9)	48 (1.9)	NSYTJ12030
Protection canopy	600 (23.6)	400 (15.7)	42 (1.7)	300 (11.8)	48 (1.9)	NSYTJ6040
Protection canopy	800 (31.5)	400 (15.7)	42 (1.7)	300 (11.8)	48 (1.9)	NSYTJ8040
Protection canopy	1000 (39.4)	400 (15.7)	42 (1.7)	300 (11.8)	48 (1.9)	NSYTJ10040
Protection canopy	1200 (47.2)	400 (15.7)	42 (1.7)	300 (11.8)	48 (1.9)	NSYTJ12040

Standard locks



NSYAEDLS6S3D

- Spacial S3DC wall-mounted enclosures are supplied with a screwdriver insert (coin protected) lock as standard.
- Large range of standardized inserts covering the most common needs.
- Installation and removal with a single screw.

Supply:
Delivered with 1 plastic key

Characteristics	References
6-mm (0.2 in.) square	NSYAEDLS6S3D
7-mm (0.3 in.) square	NSYAEDLS7S3D
8-mm (0.3 in.) square	NSYAEDLS8S3D
3-mm (0.1 in.) double-bar	NSYAEDLB3S3D
5-mm (0.2 in.) double-bar	NSYAEDLB5S3D
CNOMO 6.5-mm (0.3 in.) triangular	NSYAEDLT6S3D
8-mm (0.3 in.) triangular	NSYAEDLT8S3D

Standard handles with keys



NSYAEDL1242S3D

- Attractive and ergonomic bi-material handle.
- Large range of barrels covering the most common needs.
- Standard cam (see diagram above).
- The installation of the standard handle does not require the escutcheon to be removed.

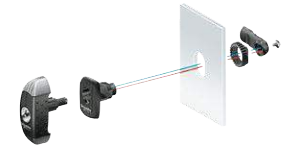

Supply:
Delivered with 1 plastic key

Characteristics	References
1242	NSYAEDL1242S3D
405	NSYAEDL405S3D
421	NSYAEDL421S3D
455	NSYAEDL455S3D
2331A	NSYAEDL2331S3D
2433A	NSYAEDL2433S3D
3113A	NSYAEDL3113S3D

Lock with screwdriver insert and metal latch



NSYAEDLSDS3D

- Material: Zamak
- Ingress protection rating: IP55 (IEC 60529)

Supply:
Delivered with housing, insert, fixing nut and metal cam 3 points

Characteristics	References
Lock with screwdriver insert and metal latch	NSYAEDLSDS3D

Double lock

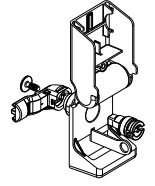

NSYAEDLPADS3D

- Easy mounting in place of the standard lock.
- Material: zamack.

Supply:
Delivered with 3-mm (0.1 in.) double-bar metal key.

Characteristics	References
DIN half-cylinder, delivered without barrel. Please contact us.	NSYAEDLDINS3D
Padlockable 405, diameter 8 mm (0.3 in.).	NSYAEDLPADS3D

Locks with keys



NSYAEDLEDF13S3D

- Material: Zamak
- Ingress protection rating: IP66 (IEC 60529)

Supply:
Easy mounting in place of the standard lock.
Metal cam supplied.

Characteristics	References
EDF 900	NSYAEDLEDF9S3D
EDF 1300	NSYAEDLEDF13S3D
EDF 1400	NSYAEDLEDF14S3D

Door hinges



NSYAEDH180S3D NSYAEDH120S3D

- Two models:
- For opening the door to an angle of 180°.
- Spare standard hinges (120°).
- Captive pin, indexed by a spring.
- Material: zamack body for catalog number **NSYAEDH180S3D**, treated sheet-steel body for catalog number **NSYAEDH120S3D**, aluminum pin.
- For the 180° hinge, the maximum allowable load on the door is 20 (44.09) kg (lbs.) / m².
- For the 120° hinge, the maximum allowable load on the door is 50 (110.23) kg (lbs.) / m².

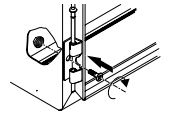

Supply:
Set of 1 hinge, delivered with hardware.

Characteristics	References
180° hinge for S3DC enclosure	NSYAEDH180S3D
Standard 120° hinge for S3DC	NSYAEDH120S3D

Inner door

- Sheet-steel door, RAL 7035 gray color.
- Locking with 3-mm (0.1 in.) double-bar lock.
- Maximum load, 30 (66.14) kg (lbs.) /m².
- The inner door can be installed directly on the front face of the enclosure or on the step slides (not supplied as standard).
- It is possible to mount an internal door and a mounting plate together on the step slides with the standard supply.
- Incompatible with the installation of the door stop and door switch. For further details, please contact us.
- All doors with a height > 700 mm (27.6 in.) are equipped with welded vertical profiles in order to facilitate cable management. Those profiles allows the mounting of our standard door cross-rail.

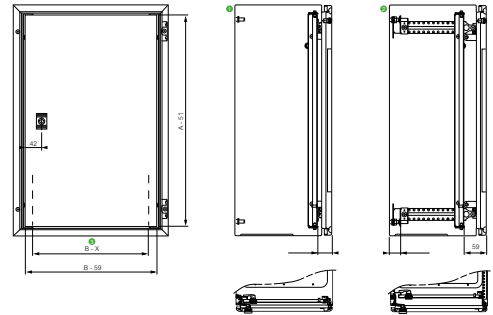

- 1 Installation on the front of the enclosure or
- 2 installation on step slides
- 3 Dimension resulting from installation on step slides:
B-83 mm (B-3.3 in.).
Dimension resulting from direct installation (without step slides): B-91 mm (B-3.6 in.).



NSYPIN43

Characteristics	High mm (in.)	Width mm (in.)	References
Inner door	400 (15.75)	300 (11.81)	NSYPIN43
Inner door	500 (19.68)	400 (15.75)	NSYPIN54
Inner door	600 (23.62)	400 (15.75)	NSYPIN64
Inner door	700 (27.56)	500 (19.68)	NSYPIN75
Inner door	800 (31.50)	600 (23.62)	NSYPIN86
Inner door	1000 (39.37)	600 (23.62)	NSYPIN106
Inner door	1000 (39.37)	800 (31.50)	NSYPIN108
Inner door	1200 (47.24)	800 (31.50)	NSYPIN128

Steel door retainer

- For blocking the door at the end of its travel.
- It is installed on enclosures with heights from 400 mm (15.7 in.) and widths from 300 mm (11.8 in.).
 - Connection for grounding the enclosure on the reinforcement rail.
 - Grounding accessories supplied with the enclosure (ground-connection cable to be ordered separately), see [Page 303](#).

Please note:
cannot be installed on 19" mounting plates or on enclosures equipped with an internal door.



NSYAEDRSCST

Characteristics	References
Steel door retainer for Spacial wall-mounted steel enclosure	NSYAEDRSCST

Door-holding system

- To hold the door open while working on the enclosure.
- It is installed on the perforated rails of the enclosure doors at the required height.
 - Material: polyamide 6 (PA6).

Comment:
It can be mounted on enclosures with a height > 400 mm (15.7 in.) [no door cross-rail on heights < 400 mm (15.7 in.)]. It cannot be installed in the Spacial CRN enclosures.



NSYAEDRS3DPA6

Characteristics	References
Door-holding system for Spacial S3DC wall-mounted steel enclosure	NSYAEDRS3DPA6

Standard cable-gland plate

Made from self-extinguishing ABS with 30% fiberglass material. Color RAL 7035.

- Pre-marked holes with diameter Pg for coupling cable glands, membrane glands, tubes, etc.
- With a polyurethane sealing gasket.
- Excellent thermal resistance.
- Pre-marked holes for cable glands.



Characteristics	Fig.	Width mm (in.)	Depth mm (in.)	To be coupled with entry	References
Standard cable-gland plate	1	250 (9.84)	150 (5.91)/200 (7.87)	A	NSYTSACRNA
Standard cable-gland plate	2	300 (11.81)	150 (5.91)/200 (7.87)	B	NSYTSACRNB
Standard cable-gland plate	3	400 (15.75)/500 (19.68)	150 (5.91)	B	NSYTSACRNB
Standard cable-gland plate	3	400 (15.75)	200 (7.87)/250 (9.84)	C	NSYTSACRNC
Standard cable-gland plate	4	500 (19.68)/600 (23.62)	200 (7.87)/250 (9.84)/300 (11.81)	D	NSYTSACRND
Standard cable-gland plate	3	800 (31.50)	200 (7.87)/250 (9.84)/300 (11.81)	E	NSYTSACRNC

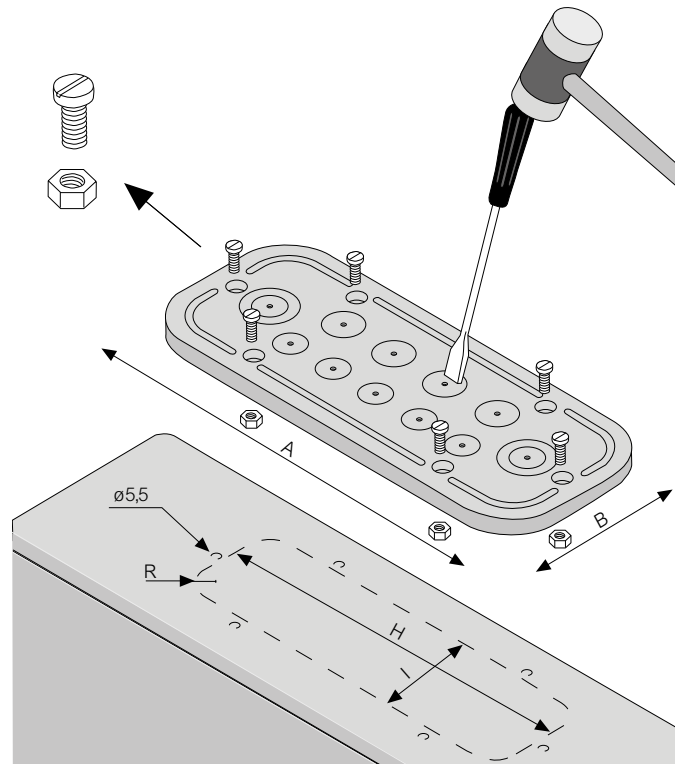
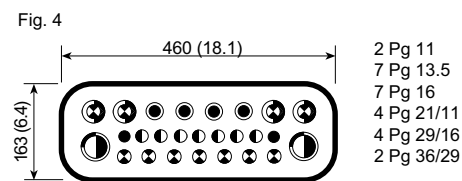
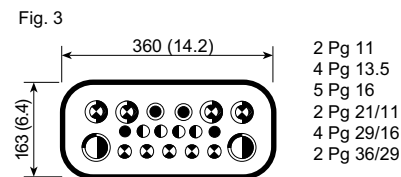
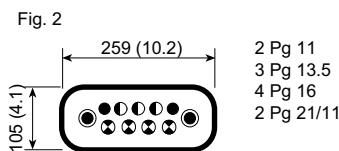
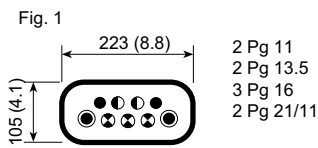

- PG 11 (18.6 mm) (0.7 in.) ● PG 21 / 11 (28.3 / 18.6 mm) (1.1 / 0.7 in.)
- PG 13.5 (20.4 mm) (0.8 in.) ● PG 29 / 16 (37 / 22.5 mm) (1.5 / 0.9 in.)
- PG 16 / 22.5 mm) (0.9 in.) ● PG 36 / 29 (47 / 37 mm) (1.9 / 1.5 in.)

Dimensions of cable-gland plate: mm (in.)		
Width	Depth	References
223 (8.8)	105 (4.1)	NSYTSACRNA
259 (10.2)	105 (4.1)	NSYTSACRNB
360 (14.2)	163 (6.4)	NSYTSACRNC
460 (18.1)	163 (6.4)	NSYTSACRND

Max.: mm (in.)				
A	B	H	I	R
223 (8.8)	105 (4.1)	180 (7.1)	62 (2.4)	18 (0.7)
259 (10.2)	105 (4.1)	216 (8.5)	62 (2.4)	18 (0.7)
360 (14.2)	163 (6.4)	317 (12.5)	120 (4.7)	32 (1.3)
460 (18.1)	163 (6.4)	417 (16.4)	120 (4.7)	32 (1.3)

Technical changes reserved. Information provided without guarantee. Images are for illustrative purposes only.

Possibility of mounting cable-gland plates on Spacial S3DC enclosures

Enclosure catalog number	Height mm (in.)	Width mm (in.)	Depth mm (in.)	NSYTSACRNA	NSYTSACRNB	NSYTSACRNC	NSYTSACRND
NSYS3DC3215	300 (11.8)	200 (7.9)	150 (5.9)	–	–	–	–
NSYS3DC3315	300 (11.8)	300 (11.8)	150 (5.9)	●	●	–	–
NSYS3DC3320	300 (11.8)	300 (11.8)	200 (7.9)	●	●	–	–
NSYS3DC4315	400 (15.7)	300 (11.8)	150 (5.9)	●	●	–	–
NSYS3DC4320	400 (15.7)	300 (11.8)	200 (7.9)	●	●	–	–
NSYS3DC4420	400 (15.7)	400 (15.7)	200 (7.9)	●	●	●	–
NSYS3DC5420	500 (19.7)	400 (15.7)	200 (7.9)	●	●	●	–
NSYS3DC5425	500 (19.7)	400 (15.7)	250 (9.8)	●	●	●	–
NSYS3DC5520	500 (19.7)	500 (19.7)	200 (7.9)	●	●	●	●
NSYS3DC5525	500 (19.7)	500 (19.7)	250 (9.8)	●	●	●	●
NSYS3DC6420	600 (23.6)	400 (15.7)	200 (7.9)	●	●	●	–
NSYS3DC6425	600 (23.6)	400 (15.7)	250 (9.8)	●	●	●	–
NSYS3DC6620	600 (23.6)	600 (23.6)	200 (7.9)	●	●	●	●
NSYS3DC6625	600 (23.6)	600 (23.6)	250 (9.8)	●	●	●	●
NSYS3DC6630	600 (23.6)	600 (23.6)	300 (11.8)	●	●	●	●
NSYS3DC7525	700 (27.6)	500 (19.7)	250 (9.8)	●	●	●	●
NSYS3DC8620	800 (31.5)	600 (23.6)	200 (7.9)	●	●	●	●
NSYS3DC8625	800 (31.5)	600 (23.6)	250 (9.8)	●	●	●	●
NSYS3DC8630	800 (31.5)	600 (23.6)	300 (11.8)	●	●	●	●
NSYS3DC8640	800 (31.5)	600 (23.6)	400 (15.7)	●	●	●	●
NSYS3DC8825	800 (31.5)	800 (31.5)	250 (9.8)	●	●	●	●
NSYS3DC8830	800 (31.5)	800 (31.5)	300 (11.8)	●	●	●	●
NSYS3DC10625	1000 (39.4)	600 (23.6)	250 (9.8)	●	●	●	●
NSYS3DC10825	1000 (39.4)	800 (31.5)	250 (9.8)	●	●	●	●
NSYS3DC10830	1000 (39.4)	800 (31.5)	300 (11.8)	●	●	●	●
NSYS3DC10840	1000 (39.4)	800 (31.5)	400 (15.7)	●	●	●	●
NSYS3DC101030	1000 (39.4)	1000 (39.4)	300 (11.8)	●	●	●	●
NSYS3DC12830	1200 (47.2)	800 (31.5)	300 (11.8)	●	●	●	●
NSYS3DC12840	1200 (47.2)	800 (31.5)	400 (15.7)	●	●	●	●
NSYS3DC121030	1200 (47.2)	1000 (39.4)	300 (11.8)	●	●	●	●

Single-door enclosure

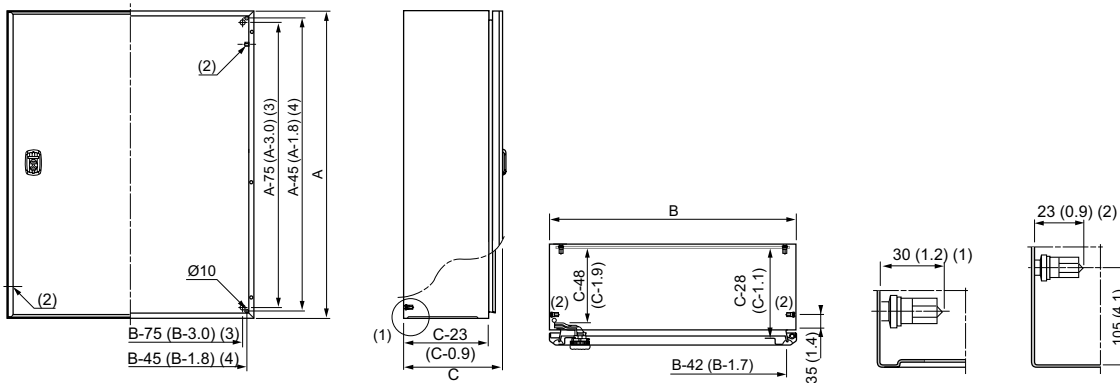

A: Enclosure height
 B: Enclosure width
 C: Enclosure depth

- 1 4 or 6 M8 x 25 mm (1.0 in.) backstuds with widths 1000 to 1200 mm (39.4 to 47.2 in.).
- 2 2 M6 x 17.5 mm (0.7 in.) grounding studs.
- 3 Stud center-to-center distance.
- 4 Center-to-center distance of the holes for direct mounting.

Comment:

The DXF diagrams can be downloaded from our websites.

Enclosure (*): mm (in.)		Perforated rails on the door: mm (in.)				Perforated rails on the internal door: mm (in.)			
Height	Width	Vertical		Horizontal		Vertical		Horizontal	
		F	D	E	C	F	D	E	C
400 (15.7)	300 (11.8)	320 (12.6)	237 (9.3)	-	-	-	-	-	-
400 (15.7)	400 (15.7)	320 (12.6)	337 (13.3)	-	-	-	-	-	-
500 (19.7)	400 (15.7)	370 (14.6)	337 (13.3)	-	-	-	-	-	-
500 (19.7)	500 (19.7)	370 (14.6)	437 (17.2)	-	-	-	-	-	-
600 (23.6)	400 (15.7)	370 (14.6)	337 (13.3)	-	-	-	-	-	-
600 (23.6)	600 (23.6)	370 (14.6)	537 (21.1)	-	-	-	-	-	-
700 (27.6)	500 (19.7)	470 (18.5)	437 (17.2)	-	-	-	-	-	-
800 (31.5)	600 (23.6)	570 (22.4)	537 (21.1)	-	-	-	-	-	-
800 (31.5)	800 (31.5)	570 (22.4)	737 (29.0)	620 (24.4)	749 (29.5)	-	-	-	-
1000 (39.4)	600 (23.6)	770 (30.3)	537 (21.1)	420 (16.5)	949 (37.4)	-	-	-	-
1000 (39.4)	800 (31.5)	770 (30.3)	737 (29.0)	620 (24.4)	949 (37.4)	-	-	-	-
1000 (39.4)	1000 (39.4)	770 (30.3)	937 (36.9)	820 (32.3)	949 (37.4)	820 (32.3)	437 (17.2)	320 (12.6)	949 (37.4)
1200 (47.2)	800 (31.5)	970 (38.2)	737 (29.0)	620 (24.4)	1149 (45.2)	-	-	-	-
1200 (47.2)	1000 (39.4)	970 (38.2)	937 (36.9)	820 (32.3)	1149 (45.2)	1020 (40.2)	437 (17.2)	320 (12.6)	1149 (45.2)

* The doors of enclosures smaller than 800 x 600 mm (31.5 X 23.6 in.) do not have horizontal cable guides.

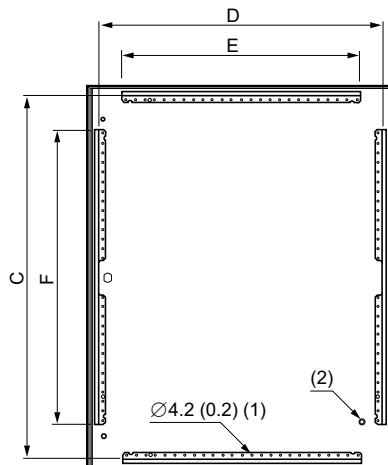

Note:

Areas without cut-outs, see Page 63.

- 1 Perforations in steps of 25 mm (1.0 in.).
- 2 1 M6 x 17.5 mm (0.7 in.) grounding stud.

You need an enclosure for indoor non-clean industrial environment.

CRN



CRNG



Time Lasting

- Industrial welding process.
 - Epoxy-polyester painting.
 - Foamed-in polyurethane gasket.
- All of the above guarantees quality, water and dust tightness for years. Front folded gutter prevents the entry of water, oil or liquids, ensuring IP66 protection



Sealed

- Glazed tempered glass door and fully water and dust tight, maintaining IP66 and IK08 protection



Safety

- For people:**
- Two welded M6 x 15 earth studs welded to the back and one M6 x 15 stud on the door
- For your installation:**
- Water and dust tightness IP66
 - Ruggedness IK10 to protect your component from external impact
 - Hidden hinges to prevent the removal of the door



Practical

- 4 welded M8 x 15 back studs shouldered 10 (0.39) mm (in.) for direct installation of mounting plate



Smart

- Welded door reinforcement profile allowing the fixing of equipment in models from 500 (19.68) mm (in.) high



Convenient

- Large embedded cable-entry plate with a neoprene seal, flush with the back of the enclosure
- Direct fixing or using the brackets fixed from outside



Characteristics	Spacial CRN	Spacial CRNG
	39 dimensions for this metal monobloc. Back piece joined to the sides using a special profile forming a protected sealed area.	<ul style="list-style-type: none"> • 17 dimensions with three-point locking system for this metal construction suite of enclosures • All Spacial CRNG models include a three-point locking system
Material	Steel	
Finish	Both externally and internally painted with texturised epoxy-polyester resin	
Color	RAL 7035 grey	
Ingress protection rating	<ul style="list-style-type: none"> • IP66 for one-door enclosures • IP55 for two-door enclosures according to IEC 60529 	
Mechanical protection rating	IK10 for plain door and IK08 for glazed door according to IEC 62262	
Standards	IEC 62208	
Certifications	<ul style="list-style-type: none"> • UL, CUL • NEMA 4 for single-door enclosure according to NEMA 250 • NEMA 12, 12K and 13 for double-door enclosure according to NEMA 250 • RoHS compliance 	
Installation	<ul style="list-style-type: none"> • Given their strength, metal enclosures are particularly well suited to indoor areas where they may experience impacts • Outdoor installation: compliant with IEC 62208 regarding type tests specified in §9.12 (resistance to ultra-violet (UV) radiation) and §9.13 (resistance to corrosion). It is always advisable to install a canopy to avoid water stagnation on the upper part of the enclosure 	
Supply	<p>Body</p> <ul style="list-style-type: none"> • 4 holes for direct mounting • Wall-mounted drill holes sealed with plastic plugs to ensure the degree of protection (supplied as standard) • Wall-mounted bracket fixed from outside (brackets to be ordered separately) • Direct cable entry • Built-in cable-entry plate, flush with the back of the enclosure (without foamed-in gasket to facilitate machining) • Insulated cable entries with knock-outs, available as an accessory • Easy to equip with 4 welded back studs shouldered 10 (0.39) mm (in.) <p>Door</p> <ul style="list-style-type: none"> • 3 (0.12) mm (in.) standard double-bar lock as standard. (Wide choice of inserts as accessories) • Foamed-in polyurethane gasket on the doors to guarantee water and dust tightness • Easily reversible door, fixed with two or three invisible hinges allowing the door to open to 120° • Reinforcement on plain doors with welded perforated door profiles for equipment mounting from models NSYCRN54150 • Metal hinges - Easily reversible door • Welded earth studs on door and body • Delivered with a reusable packaging and technical instructions 	<p>Body</p> <ul style="list-style-type: none"> • 4 holes for direct mounting • Wall-mounted drill holes sealed with plastic plugs to ensure water and dust tightness (supplied as standard) • Wall-mounted bracket fixed from outside, specific for large dimensions (to be ordered separately). • Built-in cable-entry plate, flush with the back of the enclosure (without foamed-in gasket to facilitate machining) • Easy to equip with 4 welded back studs shouldered 10 (0.39) mm (in.) (6 for widths of 1000 (39.37) and 1200 (47.24) mm (in.)) • Welded earth studs on door and body <p>Door</p> <ul style="list-style-type: none"> • Three-point locking system for one and two doors. Standard 5 (0.20) mm (in.) double-bar lock • Metal hinges - Easily reversible door • Door-centering piece on two-door enclosures to ensure proper door alignment • Foamed-in polyurethane gasket on the doors to guarantee water and dust tightness for many years • Reinforcement on plain doors with welded perforated door profiles for equipment mounting • Delivered with a reusable packaging and technical instructions

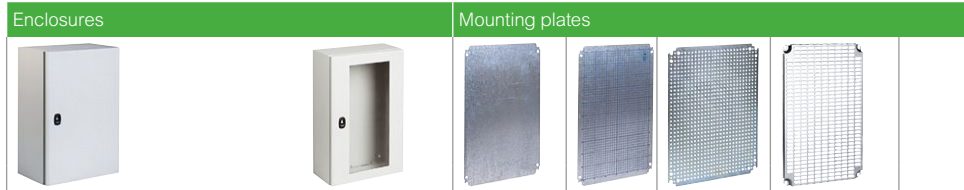









Dimensions			Doors	IP	Weight kg (lbs.) ⁽¹⁾	Enclosures			Mounting plates				
Height (A) mm (in.)	Width (B) mm (in.)	Depth (C) mm (in.)				with plain door, with mounting plate	with plain door, without mounting plate	with glazed door, with mounting plate	Plain	Silkscreened	Micro-perforated	Telequick	
CRN steel wall-mounted enclosures													
200 (7.87)	200 (7.87)	150 (5.91)	1	66	2.5 (5.51)	-	NSYCRN22150 ⁽²⁾	-	NSYMM22	-	-	-	-
200 (7.87)	300 (11.81)	150 (5.91)	1	66	3.9 (8.60)	-	NSYCRN23150 ⁽²⁾	-	NSYMM32	-	NSYMF32	-	-
250 (9.84)	200 (7.87)	150 (5.91)	1	66	3.2 (7.05)	-	NSYCRN252150P	NSYCRN252150	NSYMM2520	-	-	-	-
300 (11.81)	250 (9.84)	150 (5.91)	1	66	4.2 (9.26)	-	NSYCRN325150P	NSYCRN325150	NSYMM3025	-	-	NSYMR3025	-
300 (11.81)	250 (9.84)	200 (7.87)	1	66	4.9 (10.80)	-	NSYCRN325200P	NSYCRN325200	NSYCRN325150T	NSYMM3025	-	-	NSYMR3025
300 (11.81)	300 (11.81)	150 (5.91)	1	66	5.0 (11.02)	-	NSYCRN33150P	NSYCRN33150	NSYCRN325200T	NSYMM3025	-	-	NSYMR3025
300 (11.81)	300 (11.81)	200 (7.87)	1	66	6.0 (13.23)	-	NSYCRN33200P	NSYCRN33200	NSYCRN33150T	NSYMM33	-	NSYMF33	NSYMR33
300 (11.81)	300 (11.81)	200 (7.87)	1	66	6.0 (13.23)	-	NSYCRN33200P	NSYCRN33200	NSYCRN33200T	NSYMM33	-	NSYMF33	NSYMR33
300 (11.81)	400 (15.75)	200 (7.87)	1	66	6.4 (14.11)	-	NSYCRN34200P	NSYCRN34200	NSYCRN34200T	NSYMM43	NSYMS43	NSYMF43	NSYMR34
300 (11.81)	450 (17.72)	150 (5.91)	1	66	6.7 (14.77)	-	NSYCRN345150 ⁽²⁾	-	NSYMM3045	-	-	-	-
400 (15.75)	300 (11.81)	150 (5.91)	1	66	6.0 (13.23)	-	NSYCRN43150P	NSYCRN43150	NSYCRN43150T	NSYMM43	NSYMS43	NSYMF43	NSYMR43
400 (15.75)	300 (11.81)	200 (7.87)	1	66	6.8 (14.99)	-	NSYCRN43200P	NSYCRN43200	NSYCRN43200T	NSYMM43	NSYMS43	NSYMF43	NSYMR43
400 (15.75)	400 (15.75)	200 (7.87)	1	66	8.0 (17.64)	-	NSYCRN44200P	NSYCRN44200	NSYCRN44200T	NSYMM44	NSYMS44	NSYMF44	NSYMR44
400 (15.75)	600 (23.62)	250 (9.84)	1	66	10.0 (22.05)	-	NSYCRN46250P	NSYCRN46250	NSYCRN46250T	NSYMM64	NSYMS64	NSYMF64	NSYMR46
400 (15.75)	600 (23.62)	300 (11.81)	1	66	11.2 (24.69)	-	NSYCRN46300P	NSYCRN46300	NSYCRN46300T	NSYMM64	NSYMS64	NSYMF64	NSYMR46
500 (19.68)	400 (15.75)	150 (5.91)	1	66	8.7 (19.18)	-	NSYCRN54150P	NSYCRN54150	NSYCRN54150T	NSYMM54	NSYMS54	NSYMF54	NSYMR54
500 (19.68)	400 (15.75)	200 (7.87)	1	66	9.8 (21.61)	-	NSYCRN54200P	NSYCRN54200	NSYCRN54200T	NSYMM54	NSYMS54	NSYMF54	NSYMR54
500 (19.68)	400 (15.75)	250 (9.84)	1	66	11.0 (24.25)	-	NSYCRN54250P	NSYCRN54250	NSYCRN54250T	NSYMM54	NSYMS54	NSYMF54	NSYMR54
500 (19.68)	500 (19.68)	250 (9.84)	1	66	12.8 (28.22)	-	NSYCRN55250P	NSYCRN55250	NSYCRN55250T	NSYMM55	NSYMS55	NSYMF55	NSYMR55
600 (23.62)	400 (15.75)	150 (5.91)	1	66	9.3 (20.50)	-	NSYCRN64150P	NSYCRN64150	NSYCRN64150T	NSYMM64	NSYMS64	NSYMF64	NSYMR64
600 (23.62)	400 (15.75)	200 (7.87)	1	66	10.8 (23.81)	-	NSYCRN64200P	NSYCRN64200	NSYCRN64200T	NSYMM64	NSYMS64	NSYMF64	NSYMR64
600 (23.62)	400 (15.75)	250 (9.84)	1	66	12.3 (27.12)	-	NSYCRN64250P	NSYCRN64250	NSYCRN64250T	NSYMM64	NSYMS64	NSYMF64	NSYMR64
600 (23.62)	500 (19.68)	150 (5.91)	1	66	11.3 (24.91)	-	NSYCRN65150P	NSYCRN65150	NSYCRN65150T	NSYMM65	-	NSYMF65	NSYMR65
600 (23.62)	500 (19.68)	200 (7.87)	1	66	14.3 (31.53)	-	NSYCRN65200P	NSYCRN65200	NSYCRN65200T	NSYMM65	-	NSYMF65	NSYMR65
600 (23.62)	500 (19.68)	250 (9.84)	1	66	16.2 (35.71)	-	NSYCRN65250P	NSYCRN65250	NSYCRN65250T	NSYMM65	-	NSYMF65	NSYMR65
600 (23.62)	600 (23.62)	200 (7.87)	1	66	16.3 (35.94)	-	NSYCRN66200P	NSYCRN66200	NSYCRN66200T	NSYMM66	NSYMS66	NSYMF66	NSYMR66
600 (23.62)	600 (23.62)	250 (9.84)	1	66	18.2 (40.12)	-	NSYCRN66250P	NSYCRN66250	NSYCRN66250T	NSYMM66	NSYMS66	NSYMF66	NSYMR66
600 (23.62)	600 (23.62)	300 (11.81)	1	66	19.8 (43.65)	-	NSYCRN66300P	NSYCRN66300	NSYCRN66300T	NSYMM66	NSYMS66	NSYMF66	NSYMR66
600 (23.62)	800 (31.50)	300 (11.81)	1	66	26.0 (57.32)	-	NSYCRN68300P	NSYCRN68300	NSYCRN68300T	NSYMM86	NSYMS86	NSYMF86	NSYMR68
700 (27.56)	500 (19.68)	200 (7.87)	1	66	17.3 (38.14)	-	NSYCRN75200P	NSYCRN75200	NSYCRN75200T	NSYMM75	NSYMS75	NSYMF75	NSYMR75
700 (27.56)	500 (19.68)	250 (9.84)	1	66	19.3 (42.55)	-	NSYCRN75250P	NSYCRN75250	NSYCRN75250T	NSYMM75	NSYMS75	NSYMF75	NSYMR75
800 (31.50)	600 (23.62)	200 (7.87)	1	66	21.8 (48.06)	-	NSYCRN86200P	NSYCRN86200	NSYCRN86200T	NSYMM86	NSYMS86	NSYMF86	NSYMR86
800 (31.50)	600 (23.62)	250 (9.84)	1	66	24.8 (54.67)	-	NSYCRN86250P	NSYCRN86250	NSYCRN86250T	NSYMM86	NSYMS86	NSYMF86	NSYMR86
800 (31.50)	600 (23.62)	300 (11.81)	1	66	26.3 (57.98)	-	NSYCRN86300P	NSYCRN86300	NSYCRN86300T	NSYMM86	NSYMS86	NSYMF86	NSYMR86
800 (31.50)	800 (31.50)	200 (7.87)	1	66	29.5 (65.04)	-	NSYCRN88200P	NSYCRN88200	NSYCRN88200T	NSYMM88	-	NSYMF88	NSYMR88
800 (31.50)	800 (31.50)	300 (11.81)	1	66	32.5 (71.65)	-	NSYCRN88300P	NSYCRN88300	NSYCRN88300T	NSYMM88	-	NSYMF88	NSYMR88
1000 (39.37)	600 (23.62)	250 (9.84)	1	66	28.4 (62.61)	-	NSYCRN106250P	NSYCRN106250	NSYCRN106250T	NSYMM106	-	NSYMF106	NSYMR106
1000 (39.37)	600 (23.62)	300 (11.81)	1	66	30.6 (67.46)	-	NSYCRN106300P	NSYCRN106300	NSYCRN106300T	NSYMM106	-	NSYMF106	NSYMR106
1000 (39.37)	800 (31.50)	250 (9.84)	1	66	34.5 (76.06)	-	NSYCRN108250P	NSYCRN108250	NSYCRN108250T	NSYMM108	-	NSYMF108	NSYMR108
1000 (39.37)	800 (31.50)	300 (11.81)	1	66	37.4 (82.45)	-	NSYCRN108300P	NSYCRN108300	NSYCRN108300T	NSYMM108	-	NSYMF108	NSYMR108
CRNG Wall-mounted steel enclosures with three-point locking system													
800 (31.50)	600 (23.62)	400 (15.75)	1	66	30.0	-	NSYCRNG86400	NSYCRNG86400T	NSYMM86	NSYMS86	NSYMF86	NSYMR86	-
800 (31.50)	1000 (39.37)	300 (11.81)	2	55	40.0	-	NSYCRNG810300D	-	NSYMM108	-	NSYMF108	NSYMR810	-
800 (31.50)	1200 (47.24)	300 (11.81)	2	55	46.0	-	NSYCRNG812300D	-	NSYMM128	-	NSYMF128	2 x NSYMR86*	-
1000 (39.37)	600 (23.62)	400 (15.75)	1	66	36.0	-	NSYCRNG106400T	NSYCRNG106400T	NSYMM106	-	NSYMF106	NSYMR106	-
1000 (39.37)	800 (31.50)	400 (15.75)	1	66	43.0	-	NSYCRNG108400	NSYCRNG108400T	NSYMM108	-	NSYMF108	NSYMR108	-
1000 (39.37)	1000 (39.37)	300 (11.81)	2 ⁽³⁾	55	47.0	-	NSYCRNG1010300D	NSYCRNG1010300T	NSYMM1010	-	NSYMF1010	NSYMR1010 ⁽⁶⁾	-
1000 (39.37)	1200 (47.24)	300 (11.81)	2	55	55.0	-	NSYCRNG1012300D	-	NSYMM1210	-	NSYMF1210	NSYMR1012 ⁽⁶⁾	-
1000 (39.37)	1200 (47.24)	400 (15.75)	2	55	60.0	-	NSYCRNG1012400D	-	NSYMM1210	-	NSYMF1210	NSYMR1012 ⁽⁶⁾	-
1200 (47.24)	600 (23.62)	300 (11.81)	1	66	37.0	-	NSYCRNG126300	NSYCRNG126300T	NSYMM126	-	NSYMF126	NSYMR126	-
1200 (47.24)	600 (23.62)	400 (15.75)	1	66	42.0	-	NSYCRNG126400	NSYCRNG126400T	NSYMM126	-	NSYMF126	NSYMR126	-
1200 (47.24)	800 (31.50)	300 (11.81)	1	66	45.0	-	NSYCRNG128300	NSYCRNG128300T	NSYMM128	-	NSYMF128	NSYMR128	-
1200 (47.24)	800 (31.50)	400 (15.75)	1	66	50.0	-	NSYCRNG128400	NSYCRNG128400T	NSYMM128	-	NSYMF128	NSYMR128	-
1200 (47.24)	1000 (39.37)	300 (11.81)	2	55	56.0	-	NSYCRNG1210300D	-	NSYMM1210	-	NSYMF1210	NSYMR1210 ⁽⁶⁾	-
1200 (47.24)	1000 (39.37)	400 (15.75)	2	55	61.0	-	NSYCRNG1210400D	-	NSYMM1210	-	NSYMF1210	NSYMR1210 ⁽⁶⁾	-
1200 (47.24)	1200 (47.24)	300 (11.81)	2	55	64.0	-	NSYCRNG1212300D	-	NSYMM1212	-	2 x NSYMF126*	2 x NSYMR126*	-
1200 (47.24)	1200 (47.24)	400 (15.75)	2	55	90.0	-	NSYCRNG1212400D	-	NSYMM1212	-	2 x NSYMF126*	2 x NSYMR126*	-
1400 (55.12)	1000 (39.37)	300 (11.81)	2	55	80.0	-	NSYCRNG1410300D	-	NSYMM1410	-	-	NSYMR1410 ⁽⁶⁾	-

⁽¹⁾ Enclosure without mounting plate.

⁽²⁾ Two cable gland plates, one on the top, one on the bottom.

⁽³⁾ Except glazed door in single-door.

⁽⁴⁾ With two holes.

				Cable entries					
									
Bakelite	DIN rail chassis	Aluminum vertical rails ⁽⁶⁾	Step slides	Fig.	Type of cable entry	Cable gland plate standard	Cable gland plate insulated	Cable-gland plate with FL cut-out	FlexiCable
-	-	-	-	1	0	NSYTLCRNO	-	-	-
NSYMB32	-	-	-	1	B	NSYTLCRNB	-	-	-
-	-	-	-	1	0	NSYTLCRNO	-	-	-
NSYMB3025	-	NSYMDVR3	-	1	A	NSYTLCRNA	NSYTSACRNA	-	-
NSYMB3025	-	NSYMDVR3	NSYSDCR200	1	A	NSYTLCRNA	NSYTSACRNA	-	-
NSYMB33	NSYMD33	NSYMDVR3	-	1	B	NSYTLCRNB	NSYTSACRNB	-	-
NSYMB33	NSYMD33	NSYMDVR3	NSYSDCR200	1	B	NSYTLCRNB	NSYTSACRNB	-	-
NSYMB43	-	NSYMDVR3	NSYSDCR200	1	C	NSYTLCRNC	NSYTSACRNC	-	-
NSYMB43	-	NSYMDVR3	-	1	B	NSYTLCRNB	NSYTSACRNB	-	-
NSYMB43	NSYMD43	NSYMDVR4	-	1	B	NSYTLCRNB	NSYTSACRNB	-	-
NSYMB43	NSYMD43	NSYMDVR4	NSYSDCR200	1	B	NSYTLCRNB	NSYTSACRNB	-	-
-	-	NSYMDVR4	NSYSDCR200	1	C	NSYTLCRNC	NSYTSACRNC	-	-
NSYMB64	-	NSYMDVR4	NSYSDCR250	1	D	NSYTLCRND	NSYTSACRND	-	-
NSYMB64	-	NSYMDVR4	NSYSDCR300	1	D	NSYTLCRND	NSYTSACRND	-	-
NSYMB54	NSYMD54	NSYMDVR5	-	2	B	NSYTLCRNB	NSYTSACRNB	-	-
NSYMB54	NSYMD54	NSYMDVR5	NSYSDCR200	2	C	NSYTLCRNC	NSYTSACRNC	-	-
NSYMB54	NSYMD54	NSYMDVR5	NSYSDCR250	2	C	NSYTLCRNC	NSYTSACRNC	-	-
-	-	NSYMDVR5	NSYSDCR250	2	D	NSYTLCRND	NSYTSACRND	-	-
NSYMB64	NSYMD64	NSYMDVR6	-	2	B	NSYTLCRNB	NSYTSACRNB	-	-
NSYMB64	NSYMD64	NSYMDVR6	NSYSDCR200	2	C	NSYTLCRNC	NSYTSACRNC	-	-
NSYMB64	NSYMD64	NSYMDVR6	NSYSDCR250	2	C	NSYTLCRNC	NSYTSACRNC	-	-
NSYMB65	-	NSYMDVR6	-	2	B	NSYTLCRNB	NSYTSACRNB	-	-
NSYMB65	-	NSYMDVR6	NSYSDCR200	2	D	NSYTLCRND	NSYTSACRND	-	-
NSYMB65	-	NSYMDVR6	NSYSDCR250	2	D	NSYTLCRND	NSYTSACRND	-	-
-	NSYMD66	NSYMDVR6	NSYSDCR200	2	D	NSYTLCRND	NSYTSACRND	-	-
-	NSYMD66	NSYMDVR6	NSYSDCR250	2	D	NSYTLCRND	NSYTSACRND	-	-
-	NSYMD66	NSYMDVR6	NSYSDCR300	2	D	NSYTLCRND	NSYTSACRND	-	-
-	-	NSYMDVR6	NSYSDCR300	2	E	NSYTLCRNC ⁽⁴⁾	NSYTSACRNC	-	-
NSYMB75	NSYMD75	NSYMDVR7	NSYSDCR200	2	D	NSYTLCRND	NSYTSACRND	-	-
NSYMB75	NSYMD75	NSYMDVR7	NSYSDCR250	2	D	NSYTLCRND	NSYTSACRND	-	-
NSYMB86	NSYMD86	NSYMDVR8	NSYSDCR200	2	D	NSYTLCRND	NSYTSACRND	-	-
NSYMB86	NSYMD86	NSYMDVR8	NSYSDCR250	2	D	NSYTLCRND	NSYTSACRND	-	-
NSYMB86	NSYMD86	NSYMDVR8	NSYSDCR300	2	D	NSYTLCRND	NSYTSACRND	-	-
-	-	NSYMDVR8	NSYSDCR200	2	E	NSYTLCRNC ⁽⁴⁾	NSYTSACRNC ⁽⁵⁾	-	-
-	-	NSYMDVR8	NSYSDCR300	2	E	NSYTLCRNC ⁽⁴⁾	NSYTSACRNC ⁽⁵⁾	-	-
NSYMB106	-	NSYMDVR10	NSYSDCR250	2	D	NSYTLCRND	NSYTSACRND	-	-
NSYMB106	-	NSYMDVR10	NSYSDCR300	2	D	NSYTLCRND	NSYTSACRND	-	-
NSYMB108	NSYMD108	NSYMDVR10	NSYSDCR250	2	E	NSYTLCRNC ⁽⁴⁾	NSYTSACRNC ⁽⁵⁾	-	-
NSYMB108	NSYMD108	NSYMDVR10	NSYSDCR300	2	E	NSYTLCRNC ⁽⁴⁾	NSYTSACRNC ⁽⁵⁾	-	-
NSYMB86	NSYMD86	NSYMDVR8	NSYSDCR400	3	G	NSYTLG	-	NSYTLG2FL	NSYTLGME
-	-	NSYMDVR8	NSYSDCR300	4	H	NSYTL	-	NSYTL2FL	2 x NSYTLME
-	-	NSYMDVR8	NSYSDCR300	4	H	NSYTL	-	NSYTL2FL	2 x NSYTLME
NSYMB106	-	NSYMDVR10	NSYSDCR400	3	G	NSYTLG	-	NSYTLG2FL	NSYTLGME
NSYMB108	NSYMD108	NSYMDVR10	NSYSDCR400	4	H	NSYTL	-	NSYTL2FL	2 x NSYTLME
NSYMB1210	-	NSYMDVR10	NSYSDCR300	4	H	NSYTL	-	NSYTL2FL	2 x NSYTLME
NSYMB1210	-	NSYMDVR10	NSYSDCR300	4	H	NSYTL	-	NSYTL2FL	2 x NSYTLME
-	-	NSYMDVR10	NSYSDCR400	4	H	NSYTL	-	NSYTL2FL	2 x NSYTLME
-	-	NSYMDVR12	NSYSDCR300	3	G	NSYTLG	-	NSYTLG2FL	NSYTLGME
-	-	NSYMDVR12	NSYSDCR400	3	G	NSYTLG	-	NSYTLG2FL	NSYTLGME
-	NSYMD128	NSYMDVR12	NSYSDCR300	4	H	NSYTL	-	NSYTL2FL	2 x NSYTLME
-	NSYMD128	NSYMDVR12	NSYSDCR400	4	H	NSYTL	-	NSYTL2FL	2 x NSYTLME
NSYMB1210	-	NSYMDVR12	NSYSDCR300	4	H	NSYTL	-	NSYTL2FL	2 x NSYTLME
NSYMB1210	-	NSYMDVR12	NSYSDCR400	4	H	NSYTL	-	NSYTL2FL	2 x NSYTLME
-	-	NSYMDVR12	NSYSDCR300	4	H	NSYTL	-	NSYTL2FL	2 x NSYTLME
-	-	NSYMDVR12	NSYSDCR400	4	H	NSYTL	-	NSYTL2FL	2 x NSYTLME
-	-	-	NSYSDCR300	4	H	NSYTL	-	NSYTL2FL	2 x NSYTLME

⁽⁶⁾ For flange openings type E, two NSYTSACRNC are required.

⁽⁶⁾ Ref. NSYEMR mandatory.

⁽⁷⁾ Order NSYAMCSF, NSYMDVR12 in steel.

Not compatible with double mounting plate.

• For other dimensions see our application offer.

Dimensions			Electronic and network			Plinths 100 (3.94) mm (in.)		Plinths 200 (7.87) mm (in.)	
			Doors	Fixed 19" rack	Swing 19" rack	Single plinths side plate **	Single plinths front plate **	Single plinths side plate **	Single plinths front plate **
Height mm (in.)	Width mm (in.)	Depth mm (in.)							
CRN steel wall-mounted enclosures									
200 (440.92)	200 (440.92)	150 (330.69)	1	-	-	-	-	-	-
200 (440.92)	300 (661.39)	150 (330.69)	1	-	-	-	-	-	-
250 (551.16)	200 (440.92)	150 (330.69)	1	-	-	-	-	-	-
300 (661.39)	250 (551.16)	150 (330.69)	1	-	-	-	-	-	-
300 (661.39)	250 (551.16)	200 (440.92)	1	-	-	-	-	-	-
300 (661.39)	300 (661.39)	150 (330.69)	1	-	-	-	-	-	-
300 (661.39)	300 (661.39)	200 (440.92)	1	-	-	-	-	-	-
300 (661.39)	400 (881.85)	200 (440.92)	1	-	-	-	-	-	-
300 (661.39)	450 (992.08)	150 (330.69)	1	-	-	-	-	-	-
400 (881.85)	300 (661.39)	150 (330.69)	1	-	-	-	-	-	-
400 (881.85)	300 (661.39)	200 (440.92)	1	-	-	-	-	-	-
400 (881.85)	400 (881.85)	200 (440.92)	1	-	-	-	-	-	-
400 (881.85)	600 (1322.77)	250 (551.16)	1	NSYVDM8UF	NSYVDM7UP	-	-	-	-
400 (881.85)	600 (1322.77)	300 (661.39)	1	NSYVDM8UF	NSYVDM7UP	NSYSPS3100SD	NSYSPF6100	NSYSPS3200SD	NSYSPF6200
500 (1102.31)	400 (881.85)	150 (330.69)	1	-	-	-	-	-	-
500 (1102.31)	400 (881.85)	200 (440.92)	1	-	-	-	-	-	-
500 (1102.31)	400 (881.85)	250 (551.16)	1	-	-	-	-	-	-
500 (1102.31)	500 (1102.31)	250 (551.16)	1	-	-	-	-	-	-
600 (1322.77)	400 (881.85)	150 (330.69)	1	-	-	-	-	-	-
600 (1322.77)	400 (881.85)	200 (440.92)	1	-	-	-	-	-	-
600 (1322.77)	400 (881.85)	250 (551.16)	1	-	-	-	-	-	-
600 (1322.77)	500 (1102.31)	150 (330.69)	1	-	-	-	-	-	-
600 (1322.77)	500 (1102.31)	200 (440.92)	1	-	-	-	-	-	-
600 (1322.77)	500 (1102.31)	250 (551.16)	1	-	-	-	-	-	-
600 (1322.77)	600 (1322.77)	200 (440.92)	1	NSYVDM12UF	NSYVDM11UP	-	-	-	-
600 (1322.77)	600 (1322.77)	250 (551.16)	1	NSYVDM12UF	NSYVDM11UP	-	-	-	-
600 (1322.77)	600 (1322.77)	300 (661.39)	1	NSYVDM12UF	NSYVDM11UP	NSYSPS3100SD	NSYSPF6100	NSYSPS3200SD	NSYSPF6200
600 (1322.77)	800 (1763.70)	300 (661.39)	1	-	-	NSYSPS3100SD	NSYSPF8100	NSYSPS3200SD	NSYSPF8200
700 (1543.23)	500 (1102.31)	200 (440.92)	1	-	-	-	-	-	-
700 (1543.23)	500 (1102.31)	250 (551.16)	1	-	-	-	-	-	-
800 (1763.70)	600 (1322.77)	200 (440.92)	1	NSYVDM17UF	-	-	-	-	-
800 (1763.70)	600 (1322.77)	250 (551.16)	1	NSYVDM17UF	NSYVDM16UP	-	-	-	-
800 (1763.70)	600 (1322.77)	300 (661.39)	1	NSYVDM17UF	NSYVDM16UP	NSYSPS3100SD	NSYSPF6100	NSYSPS3200SD	NSYSPF6200
800 (1763.70)	800 (1763.70)	200 (440.92)	1	-	-	-	-	-	-
800 (1763.70)	800 (1763.70)	300 (661.39)	1	-	-	NSYSPS3100SD	NSYSPF8100	NSYSPS3200SD	NSYSPF8200
1000 (2204.62)	600 (1322.77)	250 (551.16)	1	NSYVDM21UF	NSYVDM20UP	-	-	-	-
1000 (2204.62)	600 (1322.77)	300 (661.39)	1	NSYVDM21UF	NSYVDM20UP	NSYSPS3100SD	NSYSPF6100	NSYSPS3200SD	NSYSPF6200
1000 (2204.62)	800 (1763.70)	250 (551.16)	1	-	NSYVDM20U8P	-	-	-	-
1000 (2204.62)	800 (1763.70)	300 (661.39)	1	-	NSYVDM20U8P	NSYSPS3100SD	NSYSPF8100	NSYSPS3200SD	NSYSPF8200
CRNG Wall-mounted steel enclosures with three-point locking system									
800 (1763.70)	600 (1322.77)	400 (881.85)	1	NSYVDM17UF	NSYVDM16UP	NSYSPS4100SD	NSYSPF6100	NSYSPS4200SD	NSYSPF6200
800 (1763.70)	1000 (2204.62)	300 (661.39)	2	-	-	NSYSPS3100SD	NSYSPF10100	NSYSPS3200SD	NSYSPF10200
800 (1763.70)	1200 (2645.54)	300 (661.39)	2	-	-	NSYSPS3100SD	NSYSPF12100	NSYSPS3200SD	NSYSPF12200
1000 (2204.62)	600 (1322.77)	400 (881.85)	1	NSYVDM21UF	NSYVDM20UP	NSYSPS4100SD	NSYSPF6100	NSYSPS4200SD	NSYSPF6200
1000 (2204.62)	800 (1763.70)	400 (881.85)	1	-	NSYVDM20U8P	NSYSPS4100SD	NSYSPF8100	NSYSPS4200SD	NSYSPF8200
1000 (2204.62)	1000 (2204.62)	300 (661.39)	2	-	-	NSYSPS3100SD	NSYSPF10100	NSYSPS3200SD	NSYSPF10200
1000 (2204.62)	1200 (2645.54)	300 (661.39)	2	-	-	NSYSPS3100SD	NSYSPF12100	NSYSPS3200SD	NSYSPF12200
1000 (2204.62)	1200 (2645.54)	400 (881.85)	2	-	-	NSYSPS4100SD	NSYSPF12100	NSYSPS4200SD	NSYSPF12200
1200 (2645.54)	600 (1322.77)	300 (661.39)	1	-	-	NSYSPS3100SD	NSYSPF6100	NSYSPS3200SD	NSYSPF6200
1200 (2645.54)	600 (1322.77)	400 (881.85)	1	-	-	NSYSPS4100SD	NSYSPF6100	NSYSPS4200SD	NSYSPF6200
1200 (2645.54)	800 (1763.70)	300 (661.39)	1	-	NSYVDM25U8P	NSYSPS3100SD	NSYSPF8100	NSYSPS3200SD	NSYSPF8200
1200 (2645.54)	800 (1763.70)	400 (881.85)	1	-	NSYVDM25U8P	NSYSPS4100SD	NSYSPF8100	NSYSPS4200SD	NSYSPF8200
1200 (2645.54)	1000 (2204.62)	300 (661.39)	2	-	-	NSYSPS3100SD	NSYSPF10100	NSYSPS3200SD	NSYSPF10200
1200 (2645.54)	1000 (2204.62)	400 (881.85)	2	-	-	NSYSPS4100SD	NSYSPF10100	NSYSPS4200SD	NSYSPF10200
1200 (2645.54)	1200 (2645.54)	300 (661.39)	2	-	-	NSYSPS3100SD	NSYSPF12100	NSYSPS3200SD	NSYSPF12200
1200 (2645.54)	1200 (2645.54)	400 (881.85)	2	-	-	NSYSPS4100SD	NSYSPF12100	NSYSPS4200SD	NSYSPF12200
1400 (3086.47)	1000 (2204.62)	300 (661.39)	2	-	-	NSYSPS3100SD	NSYSPF10100	NSYSPS3200SD	NSYSPF10200

(1) To be coupled in 200 (7.87) mm (in.) depth enclosure, the lifting bracket ref. NSYEX608 must be ordered separately.
 (2) 2 coupling plates and supporting poles are required.
 (3) 2 coupling plates and supporting poles are required.

Technical changes reserved. Information provided without guarantee. Images are for illustrative purposes only.

Installation system			Post-fixing	Supporting pole		Canopies	300 (11.81) mm (in.)	400 (15.75) mm (in.)	Support bracket
									
Inner door	Wall-fixing lugs	Kit for heavy loads*	Post-fixing device	Supporting pole	Coupling plates	Canopies	Floor stand kit for WM		Support bracket for enclosure with anti-tilt kit and reinforcement 1400 (55.12) mm (in.) ***

-	NSYPFCR	-	-	-	-	-	-	-	NSYCOCNS1400
-	NSYPFCR	-	-	-	-	-	-	-	NSYCOCNS1400
-	NSYPFCR	-	-	-	-	NSYTJ2015	-	-	NSYCOCNS1400
-	NSYPFCR	-	-	NSYCOCN80	NSYCHCOA	NSYTJ2515	-	-	NSYCOCNS1400
-	NSYPFCR	-	-	NSYCOCN80	NSYCHCOA	NSYTJ2520	-	-	NSYCOCNS1400
-	NSYPFCR	-	NSYSFPSC30	NSYCOCN80	NSYCHCOB	NSYTJ3015	-	-	NSYCOCNS1400
-	NSYPFCR	-	NSYSFPSC30	NSYCOCN80	NSYCHCOB	NSYTJ3020	-	-	NSYCOCNS1400
-	NSYPFCR	-	NSYSFPSC40	NSYCOCN80	NSYCHCOB	NSYTJ4020	-	-	NSYCOCNS1400
-	NSYPFCR	-	-	-	-	-	-	-	NSYCOCNS1400
NSYPIN43	NSYPFCR	-	NSYSFPSC30	NSYCOCN80	NSYCHCOB	NSYTJ3015	-	-	NSYCOCNS1400
NSYPIN43	NSYPFCR	-	NSYSFPSC30	NSYCOCN80	NSYCHCOB	NSYTJ3020	-	-	NSYCOCNS1400
-	NSYPFCR	-	NSYSFPSC40	NSYCOCN80	NSYCHCOB	NSYTJ4020	-	-	NSYCOCNS1400
-	NSYPFCR	-	NSYSFPSC60	NSYCOCN80	NSYCHCOB	NSYTJ6025	-	-	NSYCOCNS1400
-	NSYPFCR	-	NSYSFPSC60	NSYCOCN80	NSYCHCOB	NSYTJ6030	-	-	NSYCOCNS1400
NSYPIN54	NSYPFCR	-	NSYSFPSC40	NSYCOCN80	NSYCHCOB	NSYTJ4015	-	-	NSYCOCNS1400
NSYPIN54	NSYPFCR	-	NSYSFPSC40	NSYCOCN80	NSYCHCOB	NSYTJ4020	-	-	NSYCOCNS1400
NSYPIN54	NSYPFCR	-	NSYSFPSC40	NSYCOCN80	NSYCHCOB	NSYTJ4025	-	-	NSYCOCNS1400
-	NSYPFCR	-	NSYSFPSC50	NSYCOCN80	NSYCHCOB	NSYTJ5025	-	-	NSYCOCNS1400
NSYPIN64	NSYPFCR	-	NSYSFPSC40	NSYCOCN80	NSYCHCOB	NSYTJ4015	-	-	NSYCOCNS1400
NSYPIN64	NSYPFCR	-	NSYSFPSC40	NSYCOCN80	NSYCHCOB	NSYTJ4020	-	-	NSYCOCNS1400
NSYPIN64	NSYPFCR	-	NSYSFPSC40	NSYCOCN80	NSYCHCOB	NSYTJ4025	-	-	NSYCOCNS1400
-	NSYPFCR	-	NSYSFPSC50	NSYCOCN80	NSYCHCOB	NSYTJ5015	-	-	NSYCOCNS1400
-	NSYPFCR	-	NSYSFPSC50	NSYCOCN80	NSYCHCOB	NSYTJ5020	-	-	NSYCOCNS1400
-	NSYPFCR	-	NSYSFPSC50	NSYCOCN80	NSYCHCOB	NSYTJ5025	-	-	NSYCOCNS1400
-	NSYPFCR	-	NSYSFPSC60	NSYCOCN80	NSYCHCOB	NSYTJ6020	-	-	NSYCOCNS1400
-	NSYPFCR	-	NSYSFPSC60	NSYCOCN80	NSYCHCOB	NSYTJ6025	-	-	NSYCOCNS1400
-	NSYPFCR	-	NSYSFPSC60	NSYCOCN80	NSYCHCOB	NSYTJ6030	-	-	NSYCOCNS1400
-	NSYPFCR	-	NSYSFPSC80	-	NSYCHCOB (1)	NSYTJ8030	-	-	NSYCOCNS1400
NSYPIN75	NSYPFCR	-	NSYSFPSC50	NSYCOCN80	NSYCHCOB	NSYTJ5020	-	-	NSYCOCNS1400
NSYPIN75	NSYPFCR	-	NSYSFPSC50	NSYCOCN80	NSYCHCOB	NSYTJ5025	-	-	NSYCOCNS1400
NSYPIN86	NSYPFCR	-	NSYSFPSC60	NSYCOCN80	NSYCHCOB	NSYTJ6020	-	-	NSYCOCNS1400
NSYPIN86	NSYPFCR	-	NSYSFPSC60	NSYCOCN80	NSYCHCOB	NSYTJ6025	-	-	NSYCOCNS1400
NSYPIN86	NSYPFCR	-	NSYSFPSC60	NSYCOCN80	NSYCHCOB	NSYTJ6030	-	-	NSYCOCNS1400
-	NSYPFCR	-	NSYSFPSC80	-	NSYCHCOB (3)	NSYTJ8020	-	-	NSYCOCNS1400
-	NSYPFCR	-	NSYSFPSC80	-	NSYCHCOB (3)	NSYTJ8030	-	-	NSYCOCNS1400
NSYPIN106	NSYPFCR	-	-	NSYCOCN80	NSYCHCOB	NSYTJ6025	-	-	NSYCOCNS1400
NSYPIN106	NSYPFCR	-	-	NSYCOCN80	NSYCHCOB	NSYTJ6030	-	-	NSYCOCNS1400
NSYPIN108	NSYPFCR	-	-	-	NSYCHCOB (3)	NSYTJ8025	-	-	NSYCOCNS1400
NSYPIN108	NSYPFCR	-	-	-	NSYCHCOB (3)	NSYTJ8030	-	-	NSYCOCNS1400

NSYPIN86	NSYAEFPFSC	NSYAEFAHLBSC	NSYSFPSC60	-	-	NSYTJ6040	-	-	-
-	NSYAEFPFSC	NSYAEFAHLBSC	-	-	-	NSYTJ10030	NSYWWMK33	NSYWWMK34	-
-	NSYAEFPFSC	NSYAEFAHLBSC	-	-	-	NSYTJ12030	NSYWWMK33	NSYWWMK34	-
NSYPIN106	NSYAEFPFSC	NSYAEFAHLBSC	-	-	-	NSYTJ6040	-	-	-
NSYPIN108	NSYAEFPFSC	NSYAEFAHLBSC	-	-	-	NSYTJ8040	NSYWWMK43	NSYWWMK44	-
-	NSYAEFPFSC	NSYAEFAHLBSC	-	-	-	NSYTJ10030	NSYWWMK33	NSYWWMK34	-
-	NSYAEFPFSC	NSYAEFAHLBSC	-	-	-	NSYTJ12030	NSYWWMK33	NSYWWMK34	-
-	NSYAEFPFSC	NSYAEFAHLBSC	-	-	-	NSYTJ12040	NSYWWMK43	NSYWWMK44	-
NSYPIN126	NSYAEFPFSC	NSYAEFAHLBSC	-	-	-	NSYTJ6030	-	-	-
NSYPIN126	NSYAEFPFSC	NSYAEFAHLBSC	-	-	-	NSYTJ6040	-	-	-
NSYPIN128	NSYAEFPFSC	NSYAEFAHLBSC	-	-	-	NSYTJ8030	NSYWWMK33	NSYWWMK34	-
NSYPIN128	NSYAEFPFSC	NSYAEFAHLBSC	-	-	-	NSYTJ8040	NSYWWMK43	NSYWWMK44	-
-	NSYAEFPFSC	NSYAEFAHLBSC	-	-	-	NSYTJ10030	NSYWWMK33	NSYWWMK34	-
-	NSYAEFPFSC	NSYAEFAHLBSC	-	-	-	NSYTJ10040	NSYWWMK43	NSYWWMK44	-
-	NSYAEFPFSC	NSYAEFAHLBSC	-	-	-	NSYTJ12030	NSYWWMK33	NSYWWMK34	-
-	NSYAEFPFSC	NSYAEFAHLBSC	-	-	-	NSYTJ12040	NSYWWMK43	NSYWWMK44	-
-	NSYAEFPFSC	NSYAEFAHLBSC	-	-	-	NSYTJ10030	NSYWWMK33	NSYWWMK34	-

* Order the NSYAEFPFSC wall-mounted brackets separately.
 ** To install the plinth to a wall-mounted enclosure, order ref. NSYAPFWM.
 *** Available in version 1800 (70.87) mm (in.); ref. NSYCOCNS1800.

Wall-mounted kit for Spacial CRN enclosures

- Set of 4 wall fixing lugs
- They are fixed from the outside and can be positioned vertically or horizontally indistinctly.
- Maximum load: 150 (330.69) kg (lbs.)
- Not included in the standard supply
- For weights of the Spacial CRN - CRNG enclosures without mounting plate refer to the selection guide

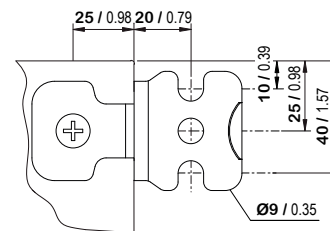

CRN Wall-fixing lugs for Spacial CRN enclosures



NSYPFCR

- Material: Passivated zinc-coated steel

Characteristics

Set of 4 wall fixing lugs for Spacial CRN enclosure

References

NSYPFCR

Supply:

Supplied with fixing screws and pre-mounted sealing gaskets

CRN Wall-fixing lugs for Spacial CRN enclosures



NSYPFC2X

- Material: Stainless-steel AISI 316L

Characteristics

Set of 4 wall fixing brackets in stainless-steel AISI 316L

References

NSYPFC2X

Supply:

Supplied with fixing screws and pre-mounted sealing gaskets

Wall-fixing lugs for Spacial CRN and CRNG enclosures

- Set of 4 wall-fixing lugs.
- Mounted directly on the rear of the enclosure, either in horizontal or vertical position.
- Wall-to-enclosure spacing 10 (0.39) mm (in.).
- Maximum load: 150 (330.69) kg (lbs.)
- Not suitable for dynamic loads.
- For weights of the Spacial CRN - CRNG enclosures without mounting plate refer to the selection guide

CRNG Wall-fixing lugs for Spacial CRNG enclosures



NSYAEFFPFC

- Material: Passivated zinc-coated steel

Characteristics

Set of 4 wall fixing lugs, made of steel

References

NSYAEFFPFC

Supply:

Supplied with fixing screws and pre-mounted sealing gaskets

CRNG Wall-fixing lugs for Spacial CRNG enclosures



NSYAEFFFXSC

- Material: Stainless-steel AISI 304L

Characteristics

Set of 4 wall fixing lugs, made of stainless-steel AISI 304L

References

NSYAEFFFXSC

Supply:

Supplied with fixing screws and pre-mounted sealing gaskets

CRNG Kit for heavy loads



NSYAEFAH RSC

- Kit made up of 2 reinforcement pieces.
- To be mounted before installing the mounting plate in top position with the standard lugs (to be ordered separately).
- Material: Passivated zinc-coated steel
- Maximum load: 400 (881.85) kg (lbs.)

Characteristics

Kit for heavy load

References

NSYAEFAHLBSC

Supply:

Kit composed with 2 brackets

Post-mounting device for Spacial steel enclosure

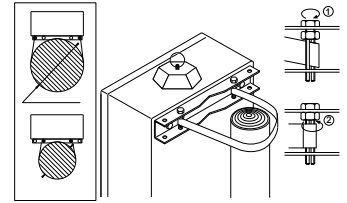
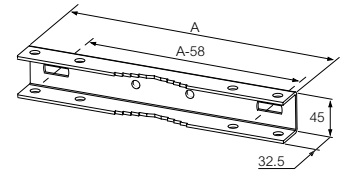

- For indoor installations on posts with a maximum circumference of 675 (26.58) mm (in.) (minimum diameter 150 (5.91) mm (in.) and maximum diameter 215 (8.46) mm (in.)).
- Rail fixed to the inserts in the rear of the enclosure with 8 (0.32) mm (in.) screws.
- They allow the mounting of protection canopies.
- Material: Galvanized steel
- Maximum load: 100 (220.46) kg (lbs.)



NSYSFPSC30

Characteristics	Width mm (in.)	A mm (in.)	References
Post-mounting device for Spacial steel enclosure	300 (11.81)	295 (11.61)	NSYSFPSC30
Post-mounting device for Spacial steel enclosure	400 (15.75)	395 (15.55)	NSYSFPSC40
Post-mounting device for Spacial steel enclosure	500 (19.68)	495 (19.49)	NSYSFPSC50
Post-mounting device for Spacial steel enclosure	600 (23.62)	595 (23.42)	NSYSFPSC60
Post-mounting device for Spacial steel enclosure	800 (31.50)	795 (31.30)	NSYSFPSC80

Support pillar

- The support pillar is fixed directly to the bottom face of the Spacial steel enclosure by means of an adapter plate. The latter, to be ordered in addition to the pillar, replaces the cable gland plate.
- Overall height of the support foot: 800 (31.50) mm (in.).
- Mounting possible on all enclosures with dimensions up to 600 (23.62) mm (in.) (except 200 (7.87) x 200 (7.87) x 150 (5.91) mm (in.) and 250 (9.84) x 200 (7.87) x 150 (5.91) mm (in.) enclosures).
- Material: Extruded aluminum
- Finish: Polyester powder
- Color: RAL 7035 grey

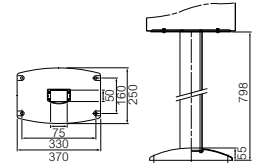

NSYCOCN80

Characteristics	Height mm (in.)	References
Support pillar	800 (31.50)	NSYCOCN80

Support pillar adaptation plate

- Description: Plate for mounting the support pillar on the enclosure.
- This plate replaces the cable gland plate delivered with the enclosure.
- Material: Steel
- Finish: Polyester powder
- Color: RAL 7035 grey

For more details see [Page 91](#)



NSYCHCOA

Characteristics	For enclosure width mm (in.)	For enclosure depth mm (in.)	To be coupled with cable entry	References
Support pillar adaptation plate	250 (9.84)	150 (5.91)-200 (7.87)	A	NSYCHCOA
Support pillar adaptation plate	300 (11.81)-400 (15.75)-450 (17.72)-500 (19.68)	150 (5.91)-200 (7.87)	B	NSYCHCOB
Support pillar adaptation plate	400 (15.75)	200 (7.87)-250 (9.84)	C	NSYCHCOC
Support pillar adaptation plate	500 (19.68)-600 (23.62)	200 (7.87)-250 (9.84)-300 (11.81)	D	NSYCHCOD

Support bracket for enclosure with anti-tilt kit and reinforcement

- The support bracket is used when the enclosure cannot be mounted to a wall or post.
- Maximum enclosure dimensions: 1000 (39.37) x 800 (31.50) x 300 (11.81) mm (in.).
- Floor attachment by standard M12 fastenings.
- Material: Steel
- Finish: Epoxy polyester paint
- Color: RAL 7035 grey
- Maximum load: 120 (264.55) kg (lbs.)



NSYCOCN1400

Characteristics	Height mm (in.)	References
Support bracket for enclosure with anti-tilt kit and reinforcement	1400 (55.12)	NSYCOCN1400
Support bracket for enclosure with anti-tilt kit and reinforcement	1800 (70.87)	NSYCOCN1800

Floor Stand Kit for wall-mounted enclosure

- Set of 2 feet, elevating wall-mounted enclosures.
- Cut-outs needed on enclosure – drilling template provided with the kit.
- Material: Steel
- Finish: Polyester powder
- Color: RAL 7035 grey
- Thickness: Sides: 2.5 (0.10) mm (in.), Base: 3 (0.12) mm (in.)
- Maximum load: 250 (551.16) kg (lbs.)
- Compatible with Spacial S3D, S3DC and CRNG enclosures.
- Enclosure depth 300 (11.81) mm (in.) : When enclosures are equipped with a cable gland plate, it only fits with enclosures of width 800 (31.50), 1000 (39.37) and 1200 (47.24) mm (in.), except model H 600 (23.62) x W 800 (31.50) x D 300 (11.81) mm (in.).
- Enclosure depth 400 (15.75) mm (in.): When enclosures are equipped with a cable gland plate, it does not fit with enclosures of width 600 (23.62) mm (in.).

Supply:
2 platform feet
(right and left) and fixing elements



NSYWMK33

Characteristics	Enclosure depth mm (in.)	Foot height mm (in.)	References
Floor stand for Spacial S3D	300 (11.81)	300 (11.81)	NSYWMK33
Floor stand for Spacial S3D	400 (15.75)	300 (11.81)	NSYWMK43
Floor stand for Spacial S3D	300 (11.81)	450 (17.72)	NSYWMK34
Floor stand for Spacial S3D	400 (15.75)	450 (17.72)	NSYWMK44

Front and rear plinths

- The front and rear of the plinth consists of 4 corners with 2 or 4 panels.
- Material: Folded sheet steel, corner with a thickness of 2.5 (0.10) mm (in.)
- Finish: Painted with epoxy-polyester resin
- Color: RAL 7022 grey
- Ingress protection rating: IP30
- Mechanical protection rating: IK10

Installation:

It is necessary to order separately the plinth fixing kit (ref. **NSYAPFWM**) composed by fixing hardware and drilling jig

Supply:

Height 100 (3.94) mm (in.): 4 corners, 2 panels (front and rear), 4 corner covers and mounting elements.
Height 200 (7.87) mm (in.): 4 corners, 4 panels (2 front and 2 rear), 4 corner covers and mounting elements



Characteristics	Width mm (in.)	Height mm (in.)	References
Front and rear plinths for Spacial	600 (23.62)	100 (3.94)	NSYSPPF6100
Front and rear plinths for Spacial	800 (31.50)	100 (3.94)	NSYSPPF8100
Front and rear plinths for Spacial	1000 (39.37)	100 (3.94)	NSYSPPF10100
Front and rear plinths for Spacial	1200 (47.24)	100 (3.94)	NSYSPPF12100
Front and rear plinths for Spacial	600 (23.62)	200 (7.87)	NSYSPPF6200
Front and rear plinths for Spacial	800 (31.50)	200 (7.87)	NSYSPPF8200
Front and rear plinths for Spacial	1000 (39.37)	200 (7.87)	NSYSPPF10200
Front and rear plinths for Spacial	1200 (47.24)	200 (7.87)	NSYSPPF12200

Plinth side panels

- They are fixed to the corner of the plinth by 2 fixing screws.
- Folded sheet steel
- Finish: Painted with epoxy-polyester resin
- Color: RAL 7022 grey
- Ingress protection rating: IP30
- Mechanical protection rating: IK10

Supply:

Height 100 (3.94) mm (in.): 2 side panels, 4 corner covers and mounting elements. Height 200 (7.87) mm (in.): 4 side panels (height of 100 (3.94) mm (in.)), 2 for each side, 4 corner covers and mounting elements



Characteristics	Depth mm (in.)	Height mm (in.)	References
Side plinths for Spacial	300 (11.81)	100 (3.94)	NSYSPPS3100SD
Side plinths for Spacial	400 (15.75)	100 (3.94)	NSYSPPS4100SD
Side plinths for Spacial	300 (11.81)	200 (7.87)	NSYSPPS3200SD
Side plinths for Spacial	400 (15.75)	200 (7.87)	NSYSPPS4200SD

Plinth

- Material: Stainless-steel, AISI 304L or AISI 316L
- Finish: Scotch-Brite® brushing, to guarantee the durability in application where the contact with the floor increases the risk of corrosion

Installation:

It is necessary to order separately the plinth fixing kit (ref. **NSYAPFXWM**) composed by mounting hardware and drilling jig



Characteristics	Width mm (in.)	Height mm (in.)	References
Plinth height 100 (3.94) mm (in.), Kit (4 corners + front and back), AISI 304L	800 (31.50)	100 (3.94)	NSYSPFX8100
Plinth height 100 (3.94) mm (in.), Kit (4 corners + front and back), AISI 304L	1000 (39.37)	100 (3.94)	NSYSPFX10100
Plinth height 100 (3.94) mm (in.), Kit (4 corners + front and back), AISI 316L	800 (31.50)	100 (3.94)	NSYSPFX8100H
Plinth height 100 (3.94) mm (in.), Kit (4 corners + front and back), AISI 316L	1000 (39.37)	100 (3.94)	NSYSPFX10100H



Characteristics	Depth mm (in.)	Height mm (in.)	References
Plinth height 100 (3.94) mm (in.), Set of 2 side panels, AISI 304L	300 (11.81)	100 (3.94)	NSYSPSX3100
Plinth height 100 (3.94) mm (in.), Set of 2 side panels, AISI 316L	300 (11.81)	100 (3.94)	NSYSPSX3100H



Characteristics	Width mm (in.)	Height mm (in.)	References
Plinth height 200 (7.87) mm (in.), Kit (4 corners + front and back), AISI 304L	800 (31.50)	200 (7.87)	NSYSPFX8200
Plinth height 200 (7.87) mm (in.), Kit (4 corners + front and back), AISI 304L	1000 (39.37)	200 (7.87)	NSYSPFX10200
Plinth height 200 (7.87) mm (in.), Kit (4 corners + front and back), AISI 316L	800 (31.50)	200 (7.87)	NSYSPFX8200H
Plinth height 200 (7.87) mm (in.), Kit (4 corners + front and back), AISI 316L	1000 (39.37)	200 (7.87)	NSYSPFX10200H

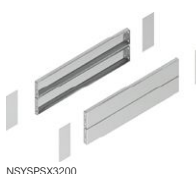

Characteristics	Depth mm (in.)	Height mm (in.)	References
Plinth height 200 (7.87) mm (in.), Set of 2 side panels (x2), AISI 304L	300 (11.81)	200 (7.87)	NSYSPSX3200
Plinth height 200 (7.87) mm (in.), Set of 2 side panels (x2), AISI 316L	300 (11.81)	200 (7.87)	NSYSPSX3200H

Coupling of Spacial steel enclosures

- Available in 2 versions:
- Coupling version without cable entry.
- Version with coupling frame allowing the entry of cables.
- Spacing of 17 (0.67) mm (in.) between 2 coupled enclosures, allowing full opening of the doors.
- Allows lateral coupling of 2 enclosures.
- These frames allow the door to open to 120°.
- Material: Fiberglass-reinforced polyester, self-extinguishing
- Ingress protection rating: IP66

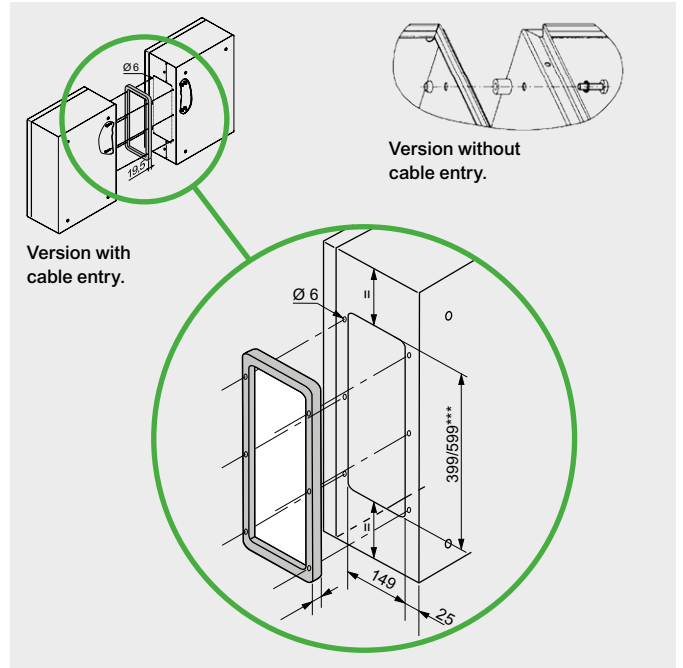

Supply:
Kit made up of 4 spacers and their mountings. Mounting by screws, included

Coupling spacers



NSYAEUBUSC

Characteristics	References
Set of 4 coupling spacers	NSYAEUBUSC

Coupling frame



NSYAEUBU41SC

Characteristics	References
Coupling frame, 435 (17.13) x 185 (7.28) mm (in.)	NSYAEUBU41SC
Coupling frame, 635 (25.00) x 185 (7.28) mm (in.)	NSYAEUBU61SC

Eyebolts



NSYAELYTCRG8

- Set of two M8 eyebolts. They are fixed directly to the body of the floor-standing enclosure. Cannot be installed with the canopy in place.
- Options: Have your cut-outs made by our configured service.
Paint touch-up pen
- Material: Zinc-coated molded steel
- Maximum load: 200 (440.92) kg (lbs.) per enclosure when slinging at 60°

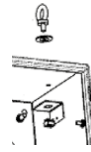

Supply:
Reinforcing brackets attached to the rings (these brackets also act as a drilling template)

Characteristics	References
Set of 2 M8 eyebolts	NSYAELYTCRG8

Protection canopy



NSYTJ2015

- Direct mounting to the body of the enclosure by 4 M6 screws.
- Material: Sheet steel
- Finish: Painted galvanized steel, structured finish
- Color: RAL 7035 grey

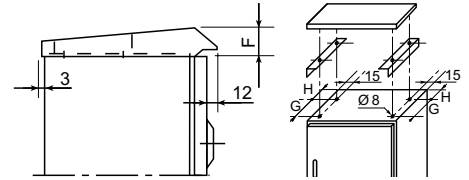

Supply:
Delivered with the mountings required for installation

Characteristics	Width mm (in.)	Depth mm (in.)	F mm (in.)	G mm (in.)	H mm (in.)	References
Protection canopy	200 (7.87)	150 (5.91)	36 (1.42)	75 (2.95)	23 (0.91)	NSYTJ2015
Protection canopy	250 (9.84)	150 (5.91)	36 (1.42)	75 (2.95)	23 (0.91)	NSYTJ2515
Protection canopy	300 (11.81)	150 (5.91)	36 (1.42)	75 (2.95)	23 (0.91)	NSYTJ3015
Protection canopy	400 (15.75)	150 (5.91)	36 (1.42)	75 (2.95)	23 (0.91)	NSYTJ4015
Protection canopy	500 (19.68)	150 (5.91)	36 (1.42)	75 (2.95)	23 (0.91)	NSYTJ5015
Protection canopy	500 (19.68)	200 (7.87)	36 (1.42)	130 (5.12)	23 (0.91)	NSYTJ5020
Protection canopy	600 (23.62)	200 (7.87)	36 (1.42)	130 (5.12)	23 (0.91)	NSYTJ6020
Protection canopy	250 (9.84)	200 (7.87)	36 (1.42)	130 (5.12)	23 (0.91)	NSYTJ2520
Protection canopy	300 (11.81)	200 (7.87)	36 (1.42)	130 (5.12)	23 (0.91)	NSYTJ3020
Protection canopy	400 (15.75)	200 (7.87)	36 (1.42)	130 (5.12)	23 (0.91)	NSYTJ4020
Protection canopy	800 (31.50)	200 (7.87)	36 (1.42)	130 (5.12)	23 (0.91)	NSYTJ8020
Protection canopy	400 (15.75)	250 (9.84)	42 (1.65)	150 (5.91)	48 (1.89)	NSYTJ4025
Protection canopy	500 (19.68)	250 (9.84)	42 (1.65)	150 (5.91)	48 (1.89)	NSYTJ5025
Protection canopy	600 (23.62)	250 (9.84)	42 (1.65)	150 (5.91)	48 (1.89)	NSYTJ6025
Protection canopy	800 (31.50)	250 (9.84)	42 (1.65)	150 (5.91)	48 (1.89)	NSYTJ8025
Protection canopy	600 (23.62)	300 (11.81)	42 (1.65)	200 (7.87)	48 (1.89)	NSYTJ6030
Protection canopy	800 (31.50)	300 (11.81)	42 (1.65)	200 (7.87)	48 (1.89)	NSYTJ8030
Protection canopy	1000 (39.37)	300 (11.81)	42 (1.65)	200 (7.87)	48 (1.89)	NSYTJ10030
Protection canopy	1200 (47.24)	300 (11.81)	42 (1.65)	200 (7.87)	48 (1.89)	NSYTJ12030
Protection canopy	600 (23.62)	400 (15.75)	42 (1.65)	300 (11.81)	48 (1.89)	NSYTJ6040
Protection canopy	800 (31.50)	400 (15.75)	42 (1.65)	300 (11.81)	48 (1.89)	NSYTJ8040
Protection canopy	1000 (39.37)	400 (15.75)	42 (1.65)	300 (11.81)	48 (1.89)	NSYTJ10040
Protection canopy	1200 (47.24)	400 (15.75)	42 (1.65)	300 (11.81)	48 (1.89)	NSYTJ12040

Lock for Spacial CRN enclosure

- **NSYCDB3** 3 (0.12) mm (in.) Ø standard double-bar lock.
- By mounting the wing nut to the lock, the double-bar lock becomes a handle lock.
- Operation using:
wing key ref.: **NSYDBP**
key NSYLDB5 (according to DIN 43668) 
- **NSYTDBC** delivered with 1 metal key

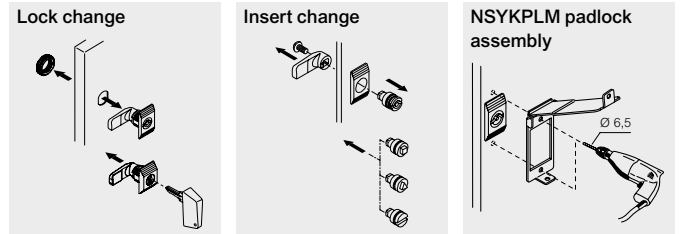

Inserts



Characteristics	Key references	References
3 (0.12) mm (in.) double-bar	NSYLDB5	NSYTDBC
6 (0.24) mm (in.) square	NSYLC7	NSYTC6
7 (0.28) mm (in.) square	NSYLC7	NSYTC7
8 (0.32) mm (in.) square	NSYLC8	NSYTC8
6.5 (0.26) mm (in.) triangular	NSYLT8	NSYTT6
7 (0.28) mm (in.) triangular	NSYLT8	NSYTT7
8 (0.32) mm (in.) triangular	NSYLT8	NSYTT8
Screw driver lock		NSYAEDLS

Keys



- Insert without keys (unless indicated)

Characteristics	References
Metal key for 5 (0.20) mm (in.) double-bar insert	NSYLDB5
Metal key for 7 (0.28) mm (in.) square insert	NSYLC7
Metal key for 8 (0.32) mm (in.) square insert	NSYLC8
Metal key for 8 (0.32) mm (in.) triangular insert	NSYLT8

Complete locks

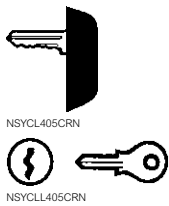

Characteristics	References
Complete manual handle lock, operated with key 405	NSYCL405CRN
Complete manual handle lock, operated with key 220	NSYCL220CRN
Complete metal lock, operated with key 405E	NSYCLL405CRN

Padlocks



Characteristics	References
Padlock device for WM enclosures, Ø 8 (0.32) mm (in.)	NSYKPLM
Padlock for Spacial CRN enclosure, Ø 7.5 (0.30) mm (in.) / Ø 10 (0.39) mm (in.)	NSYCBCCRN

Lock for Spacial CRNG enclosure (three-point lock)

- Standard 5 (0.20) mm (in.) double-bar lock for CRNG models.
- Operation using: Key **NSYLD5** (according to DIN 43668)

Transformation of the standard lock to standardised variations in enclosures with three-point locks

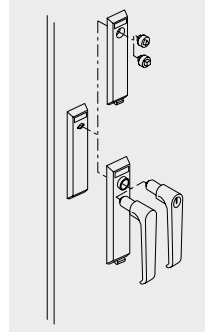

Transformation of the standard lock to a retractable three-point lock with various types of inserts

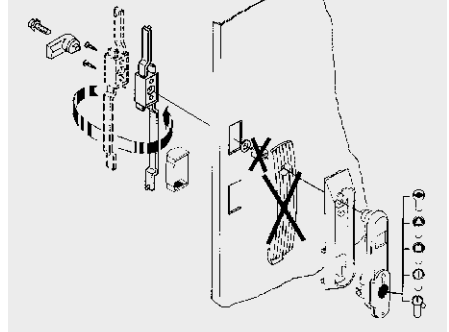

Transformation of the standard lock to standardised variations in enclosures with three-point locks



NSYTC6ML

Type of insert	Key references	References
6 (0.24) mm (in.) square	NSYLC7	NSYTC6ML
7 (0.28) mm (in.) square	NSYLC7	NSYTC7ML
8 (0.32) mm (in.) square	NSYLC8	NSYTC8ML
7 (0.28) mm (in.) side triangular	NSYLT8	NSYTT7ML
8 (0.32) mm (in.) side triangular	NSYLT8	NSYTT8ML

Handle locks for transformation of the standard lock to standardised variations in enclosures with three-point locks



NSYTL405SML

Characteristics	References
Handle lock	NSYTSML
Handle lock operated using key 405 (included)	NSYTL405SML

Transformation of the standard lock to a retractable three-point lock with various types of inserts



NSYTEL405ML

Characteristics	Key references	References
Key operated bar lock	NSYLD5	NSYTEDB5ML
8 (0.32) mm (in.) square lock	NSYLC8	NSYTEC8ML
7 (0.28) mm (in.) side triangular lock	NSYLT8	NSYET7ML
8 (0.32) mm (in.) side triangular lock	NSYLT8	NSYET8ML
Lock operated with key type 405		NSYTEL405ML
Lock operated with reinforced key		NSYTERML

Keys



NSYLD5
NSYLC8
NSYLT8

- Insert without keys (unless indicated)

Characteristics	References
Metal key for 5 (0.20) mm (in.) double-bar insert	NSYLD5
Metal key for 7 (0.28) mm (in.) square insert	NSYLC7
Metal key for 8 (0.32) mm (in.) square insert	NSYLC8
Metal key for 8 (0.32) mm (in.) triangular insert	NSYLT8

Padlocking accessories

- Padlocking system, positioned around the long rectangular escutcheon of the enclosures, to block access to the lock, for a Ø 9 (0.35) mm (in.) padlock.



NSYBCPL

Characteristics	References
Padlock device for large rectangular escutcheon of PLM 108 and PL	NSYBCPL

- Padlocking system, to block access to the retractable handle, for a Ø 9 (0.35) mm (in.) padlock.



NSYBCME

Characteristics	References
Spacial SFX - SMX enclosures - padlocking device for retractable handle	NSYBCME

Standard cable gland plates

- The cable gland plate for Spacial CRN guarantees water and dust tightness.
- Material: Steel
- Color: RAL 7035 grey
- Installation: Fixing with screws, it is flattened with the body
- Type E: Enclosure with 2 entries

Supply:
Included as a standard with the Spacial CRN enclosure. It is delivered with a separate seal: It allows easy cut-outs with no risk of damaging the seal and can be easily repainted.



NSYTLCRNO

Characteristics	Width mm (in.)	Depth mm (in.)	To be coupled with entry	References
Standard cable gland plate	200 (7.87)	150 (5.91)	0	NSYTLCRNO
Standard cable gland plate	250 (9.84)	150 (5.91)/200 (7.87)	A	NSYTLCRNA
Standard cable gland plate	300 (11.81)	150 (5.91)/200 (7.87)	B	NSYTLCRNB
Standard cable gland plate	400 (15.75)/500 (19.68)	150 (5.91)	B	NSYTLCRNB
Standard cable gland plate	400 (15.75)	200 (7.87)/250 (9.84)	C	NSYTLCRNC
Standard cable gland plate	500 (19.68)/600 (23.62)	200 (7.87)/250 (9.84)/300 (11.81)	D	NSYTLCRND
Standard cable gland plate	800 (31.50)	200 (7.87)/250 (9.84)/300 (11.81)	E	NSYTLCRNC

Insulated cable gland plates

- With a polyurethane sealing gasket.
- Excellent thermal resistance.
- Pre-marked holes for cable entry plates.
- Material: Self-extinguishing ABS with 30% fiberglass
- Color: RAL 7035 grey
- Installation: Pre-marked holes with diameter Pg for coupling of cable glands, membrane glands, tubes, etc
- For type E cable entry, use two **NSYTSACRNC**.

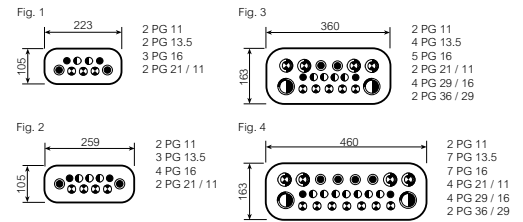

For more details see [page 70](#)



Characteristics	Fig.	Width mm (in.)	Depth mm (in.)	To be coupled with entry	References
Insulated cable gland plate	1	250 (9.84)	150 (5.91)/200 (7.87)	A	NSYTSACRNA
Insulated cable gland plate	2	300 (11.81)	150 (5.91)/200 (7.87)	B	NSYTSACRNB
Insulated cable gland plate	3	400 (15.75)/500 (19.68)	150 (5.91)	B	NSYTSACRNB
Insulated cable gland plate	3	400 (15.75)	200 (7.87)/250 (9.84)	C	NSYTSACRNC
Insulated cable gland plate	4	500 (19.68)/600 (23.62)	200 (7.87)/250 (9.84)/300 (11.81)	D	NSYTSACRND
Insulated cable gland plate	3	800 (31.50)	200 (7.87)/250 (9.84)/300 (11.81)	E	NSYTSACRNC

Standard cable gland plates

- Cable entries
- Material: Steel painted with textured epoxy-polyester resin
- Color: RAL 7035 grey
- Ingress protection rating: IP66
- Installation: Surface with a grid pattern in 25 (0.98) mm (in.) intervals to facilitate perforation. Mounting with screws

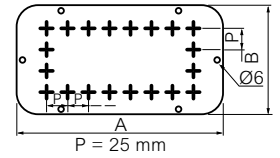

Supply:
Standard supply with the Spacial CRNG enclosures



Characteristics	Width mm (in.)	Depth mm (in.)	To be coupled with entry	Dimensions A x B mm (in.)	References
Standard cable gland plate	600 (23.62)	400 (15.75)	G	495 (19.49) x 220 (8.66)	NSYTLG
Standard cable gland plate	800 (31.50)	300 (11.81)- 400 (15.75)	H (2 entries)	345 (13.58) x 130 (5.12)	NSYTLG
Standard cable gland plate	1000 (39.37)- 1200 (47.24)	300 (11.81)- 400 (15.75)	H (2 entries)	445 (17.52) x 130 (5.12)	NSYTLG

Cable gland plates for membrane glands

- Cable entries
- FL21 cut-outs
- Material: Steel painted with textured epoxy-polyester resin
- Color: RAL 7035 grey
- Ingress protection rating: The membranes are built to accommodate water and dust tight cable entries in insulated material (flame classification V0), guaranteeing IP65 (to be ordered separately)
- Installation: Mounting with screws

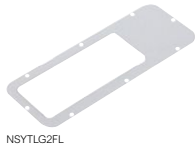
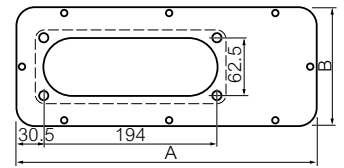

Characteristics	Width mm (in.)	Depth mm (in.)	To be coupled with entry	Dimensions A x B mm (in.)	References
For membrane glands	600 (23.62)	400 (15.75)	G	495 (19.49) x 220 (8.66)	NSYTLG2FL
For membrane glands	800 (31.50)	300 (11.81)- 400 (15.75)	H	345 (13.58) x 130 (5.12)	NSYTLG2FL
For membrane glands	1000 (39.37)- 1200 (47.24)	300 (11.81)- 400 (15.75)	H	445 (17.52) x 130 (5.12)	NSYTLG2FL

Internal door

- Locking with 3 (0.12) mm (in.) double-bar lock.
- The internal door can be installed directly on the front face of the enclosure or on the step slides (not supplied as standard).
- To mount an inner door and a mounting plate at the same time on the step slides is possible as standard.
- Material: Sheet-steel
- Color: RAL 7035 grey
- Maximum load: 30 (66.14) kg (lbs.)/m²

Note:
Not compatible with mounting with door stop and door contact. Consult us.
⁽¹⁾ Equipped with welded vertical profiles in order to facilitate cable management.



NSYPIN43

Characteristics	High mm (in.)	Width mm (in.)	References
Internal door	400 (15.75)	300 (11.81)	NSYPIN43
Internal door	500 (19.68)	400 (15.75)	NSYPIN54
Internal door	600 (23.62)	400 (15.75)	NSYPIN64
Internal door	700 (27.56)	500 (19.68)	NSYPIN75
Internal door	800 (31.50)	600 (23.62)	NSYPIN86 ⁽¹⁾
Internal door	1000 (39.37)	600 (23.62)	NSYPIN106 ⁽¹⁾
Internal door	1000 (39.37)	800 (31.50)	NSYPIN108 ⁽¹⁾
Internal door	1200 (47.24)	600 (23.62)	NSYPIN126
Internal door	1200 (47.24)	800 (31.50)	NSYPIN128 ⁽¹⁾

Dimensions

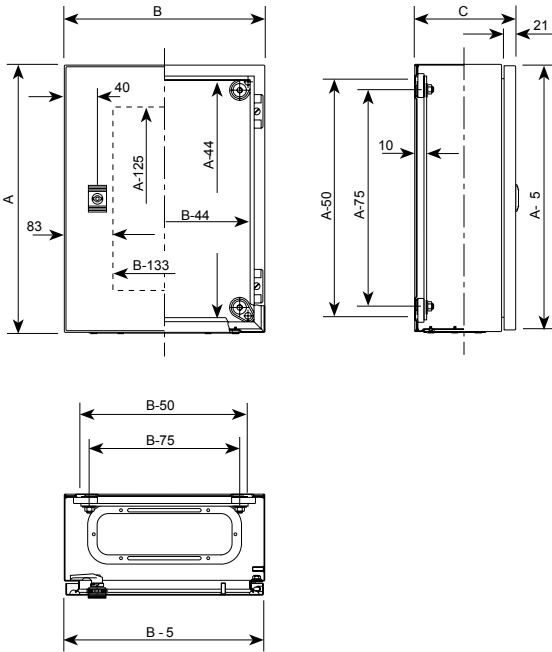

Fig. 1

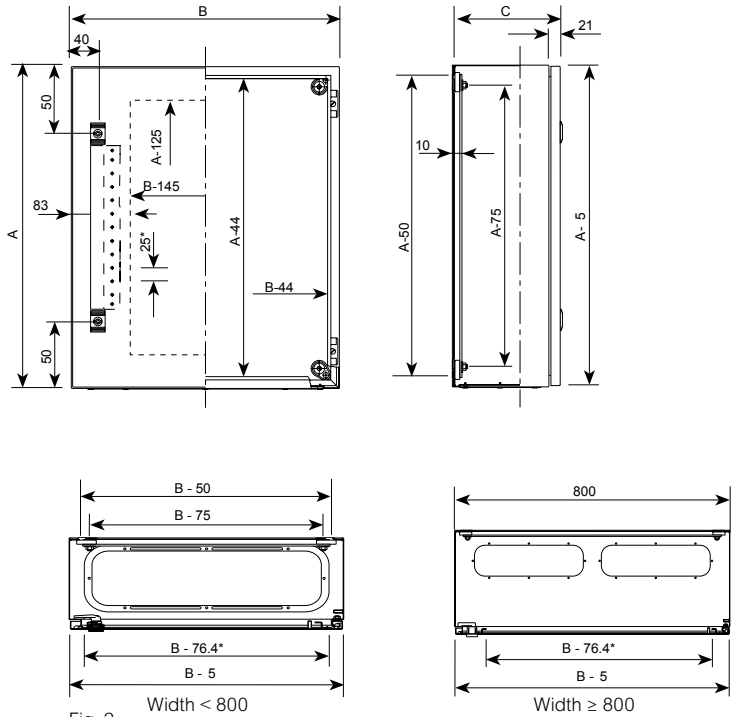
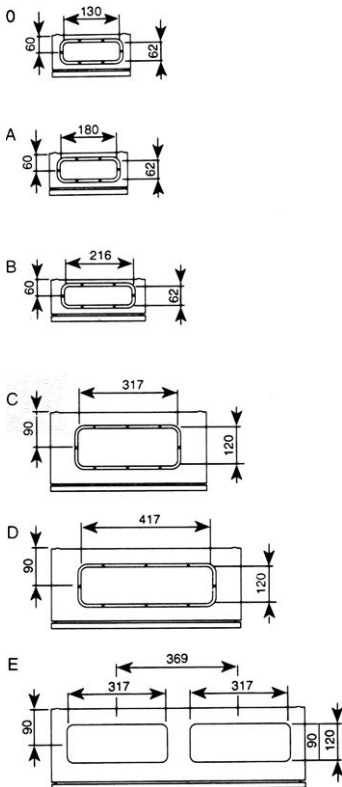

Fig. 2

A: Enclosure height
 B: Enclosure width
 C: Enclosure depth

Spacial CRN cable entry dimensions and type



None of the T glazed-door enclosures have door reinforcement profiles.

Our DXF diagrams and technical instruction sheets can be downloaded from our websites.

Technical changes reserved. Information provided without guarantee. Images are for illustrative purposes only.

Dimensions

A: Enclosure height, B: Enclosure width, C: Enclosure depth

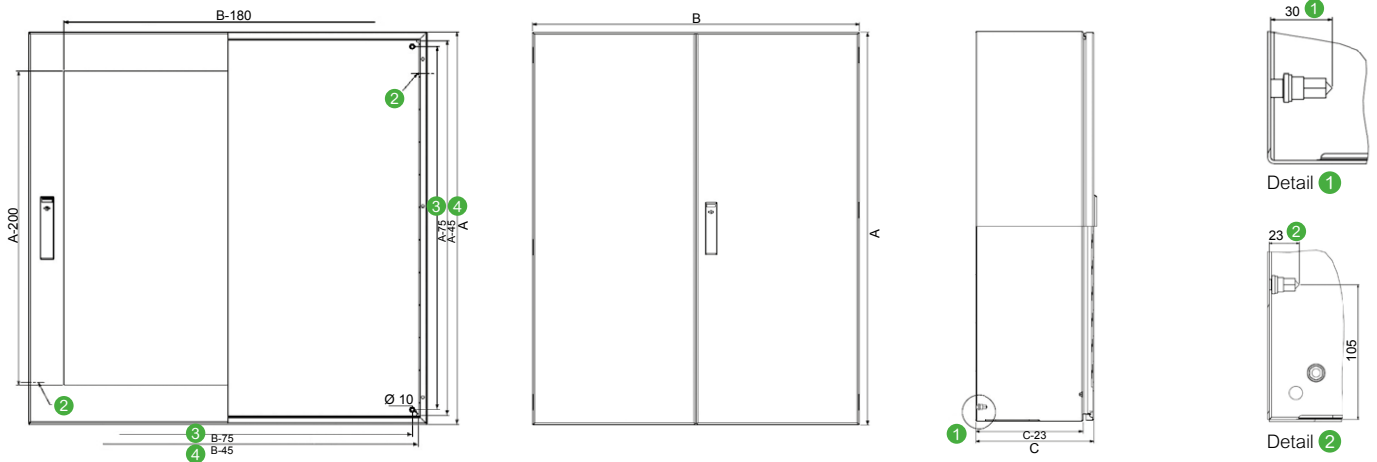

Dimensions of enclosure mm (in.)					
Width (B)	Depth (C)	J	K	L	M
600 (23.62)	300 (11.81)-400 (15.75)	126 (4.96)	470 (18.50)	195 (7.68)	-
800 (31.50)	300 (11.81)-400 (15.75)	95 (3.74)	320 (12.60)	105 (4.13)	400 (15.75)
1000 (39.37) (5)	300 (11.81)	125 (4.92)	420 (16.54)	105 (4.13)	500 (19.68)
1000 (39.37)	300 (11.81)-400 (15.75)	95 (3.74)	420 (16.54)	105 (4.13)	500 (19.68)
1200 (47.24)	300 (11.81)	95 (3.74)	420 (16.54)	105 (4.13)	500 (19.68)
	400 (15.75)	125 (4.92)	420 (16.54)	105 (4.13)	600 (23.62)

- 1 Four M8 x 25 back studs
- 2 Two M6 x 17.5 earth studs
- 3 Spacing between the studs
- 4 Spacing between the perforations for direct fixing
- 5 Only models 1400 (55.12) x 1000 (39.37) x 300 (11.81)

A: Enclosure height
B: Enclosure width
C: Enclosure depth

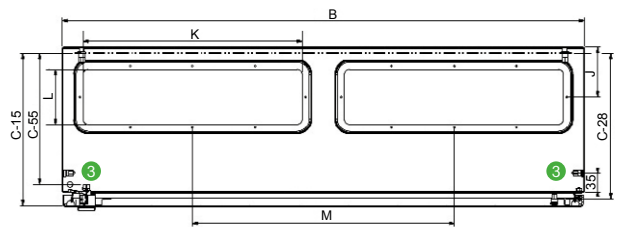

Cable entry type H: Enclosure width \geq 800 (31.50) mm (in.).

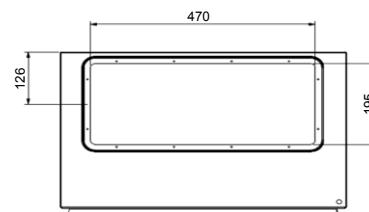

Cable entry type G: Enclosure width 600 (23.62) mm (in.).

Dimensions of the door-reinforcement profiles, the T doors only include vertical profiles

Single-door enclosure mm (in.)		Reinforcement profile	
Height (A)	Width (B)	F	D
800 (31.50)	600 (23.62)	620 (24.41)	487 (19.17)
1000 (39.37)	600 (23.62)	820 (32.28)	487 (19.17)
	800 (31.50)	820 (32.28)	687 (27.05)
1200 (47.24)	600 (23.62)	1020 (40.16)	480 (18.90)
	800 (31.50)	1020 (40.16)	687 (27.05)

Double-door enclosure mm (in.)		Reinforcement profile			
Height (A)	Width (B)	Rt. Door		Lft. Door	
		F	D	F	D
800 (31.50)	1000 (39.37)	620 (24.41)	387 (15.24)	620 (24.41)	437 (17.20)
	1200 (47.24)	620 (24.41)	487 (19.17)	620 (24.41)	537 (21.14)
1000 (39.37)	1000 (39.37)	820 (32.28)	387 (15.24)	820 (32.28)	437 (17.20)
	1200 (47.24)	820 (32.28)	487 (19.17)	820 (32.28)	537 (21.14)
1200 (47.24)	1000 (39.37)	1020 (40.16)	387 (15.24)	1020 (40.16)	437 (17.20)
	1200 (47.24)	1020 (40.16)	487 (19.17)	1020 (40.16)	537 (21.14)
1400 (55.12)	1000 (39.37)	1020 (40.16)	387 (15.24)	1020 (40.16)	437 (17.20)

- 6 25 (0.98) mm (in.) passage
- 7 1 M6 x 17.5 earth stud

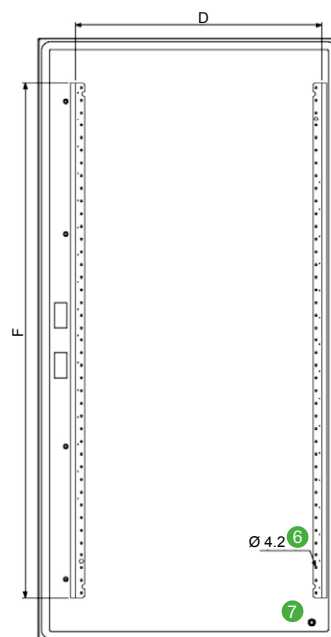

Download our DXF diagrams from our website.

Technical changes reserved. Information provided without guarantee. Images are for illustrative purposes only.

Internal door

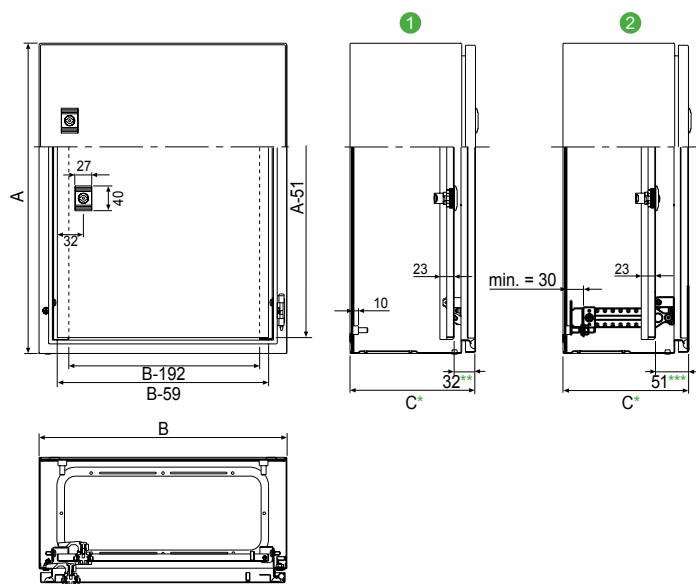

- ① NSYPIN●●● internal door fixed directly to the enclosure.
- ② NSYPIN●●● internal door fixed to the adjustable NSYSDCR support. In this case, both the internal door and the mounting plate may be depth adjustable.

* Dimension C according to general table on [Page 76](#).

** Except H 1200 x W 600: 38.3.

*** Except H 1200 x W 600: 59 and H 1200 x W 800: 52

Steel Floor-Standing Enclosures

3

Compact enclosures Spacial SM



Suitable enclosures Spacial SF - Assembled supply



Spacial SM-SF	
Introduction	96
Characteristics	98
Selection guide	100
Accessories	106
Dimensions	132

Multi-purpose IP55 compact steel enclosure for fast and simple solutions.

3



SM



Robust

- Body made as a single piece with welded rear panel.
- Front part forming a rigid frame with welded corners.



Protection

- IP guaranteed by the rigidity of the enclosure, the expanded-polyurethane sealing gasket of the enclosure and the subsequent welding.
- Double-door enclosures with inner lock on the left door.



Practical

- Height-adjustable door rails suitable for cable fixing.
- Can be installed adaptation profile in the front and rear of the enclosure and the universal 40 (15.75 mm (in.) cross-rail (1 row) in the rear provide the same fixing points as the modular enclosure.



Comfort

- Handle with sturdy design for easily activating the locking system, allowing the installation of any shape insert and any cylindrical combination key.
- Easily interchangeable insert with one click.

For details consult our web site
www.se.com

Adapts to all your needs. Delivered assembled for a ready-to-use solution.

SF



• 15 (0.59)/10° mm (in.)

Adapts to customer needs. Delivered as kit, with up to 600 possible configurations.

SF kit

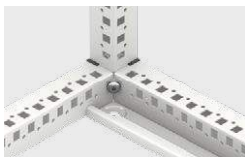
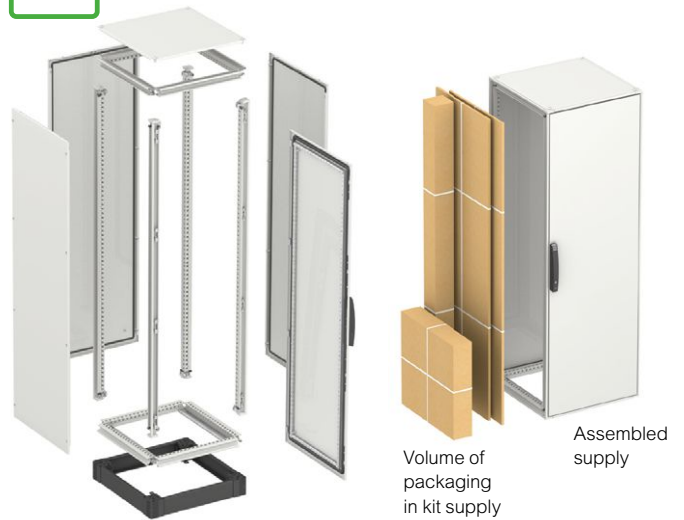

Robust

- Structure formed from a single 15 (0.59)/10° mm (in.) galvanized steel section with high rigidity.
- Vertical uprights screwed together with connections of full steel. Placement and screwing of the 4 vertical uprights at the corners of the top and bottom frames. Fixing by 8 screws, one at each corner of the enclosure.
- Capable of withstanding 1000 (2204.62) kg (lbs.) distributed in its volume.



Fast

- The double system of cut-outs on the structure allows most accessories to be installed using self-tapping TORX T30 M6 screws or nuts.
- Clip-on quick-fixing cross-rails, fixed with self-tapping screws.
- Door is installed by inserting the captive pins of the hinge into their housing in the door.

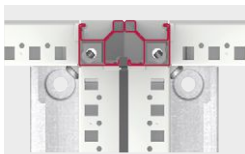

Reliable

- The design of the profile creates a double protective barrier against the entry of water and dust when coupling two enclosures.
- The first barrier is the metal connection of the sections, and the second barrier is the EPDM gasket that helps guarantee the sealing.



Practical

- Suspension of the rear panel using a self-centering piece to facilitate screwing.

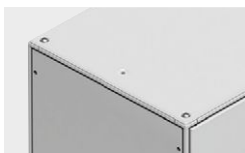

Aesthetics

- The built-in panels and handle with new design give the enclosure a new appearance.



Simple

The new design allows enclosures to be coupled in any direction, adapting to all installation surfaces.

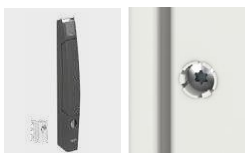

Comfort

- Handle with robust design for easily activating the locking system, allowing the installation of inserts of any shape and any cylindrical combination key.
- Panels with captive screws for easier assembly and dismantling.



Accessible

The symmetric design of the profile allows doors to be installed on any side of the enclosure, opening right or left, providing full accessibility to the enclosure.

Technical changes reserved. Information provided without guarantee. Images are for illustrative purposes only.



SM

Characteristics	<p>Compact enclosures Spacial SM</p> <ul style="list-style-type: none"> • Compact body with a front rigid frame with welded corners and rear panel supports installed in depth to adjust and fix the equipment with a pitch of 25 (0.98) mm (in.)
Basic composition	<ul style="list-style-type: none"> • The double-doors are overlapping, with system for fixing the left door • Door reversible, 120° opening • Welded rear panel • System with 4 locking points with handle and 5 (0.20) mm (in.) double-bar insert • Cable gland plate 1 entry • Mounting plate support brackets
Versions / Configurations	<ul style="list-style-type: none"> • Compact enclosure with plain door and mounting plate • Compact enclosure with plain door and without mounting plate • Compact enclosure with transparent Securit® glass door and without mounting plate
Protection of personnel	Earthing accessories needed to ensure the grounding continuity, page 303
Material	Steel
Finish	Structured finish, epoxy polyester powder
Color	RAL 7035 grey
Ingress protection rating	IP55 according to IEC 60529
Mechanical protection rating	IK10 for plain door and IK08 for transparent door according to IEC 62262
Standards	Compliance with enclosure standard IEC 62208 and the RoHS and REACH directive
Certifications	BV, DNV, UL * and cUL, *1 door: 1, 2, 3R, 4, 5 and 13, * 2 doors: 1, 12
Installation	<ul style="list-style-type: none"> • Compliant with IEC 62208 regarding type tests specified in §9.12 (resistance to UV radiation) and §9.13 (resistance to corrosion) • Canopy needed to avoid water stagnation on the upper part of the enclosure, page 121
Maximum load	500 (1102.31) kg (lbs.)
Options	<ul style="list-style-type: none"> • Plinths, heights 100 (3.94) mm (in.) and 200 (7.87) mm (in.), page 112 • Lifting eyebolts, page 120 • Internal door, page 125 • Door accessories, page 127 • Other locking options, page 130 • Mounting plates and Telequick system, page 245



SF

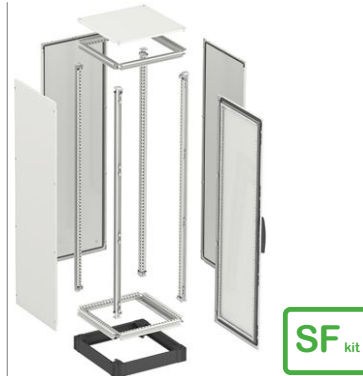

SF_{kit}

Suitable enclosures Spacial SF - supplied assembled

- Structure made up of vertical uprights joined with top and bottom frames
- Panels and doors built into the structure
- Formed from a single section and perforated structure with a pitch of 25 (0.98) mm (in.)
- Front door with a reinforcement frame (horizontal rails height-adjustable)
- The double-doors are overlapping, with system for fixing the left door
- Door reversible, 120° opening
- Rear panel screwed on with captive screws
- Removable roof
- 4 locking points system with handle 5 (0.20) mm (in.) double-bar insert
- Mounting plate support brackets (for widths from 600 (23.62) mm (in.))
- Mounting plate sliding rails (for widths from 600 (23.62) mm (in.))
- 2 quick-fixing cross-rails (for heights from 1800 (70.87) mm (in.), widths from 600 (23.62) mm (in.) and depths from 500 (19.68) mm (in.))

- Modular enclosure with plain door and mounting plate
- Modular enclosure with plain door and without mounting plate
- Modular enclosure with transparent Securit® glass door and without mounting plate

Earthing accessories needed to ensure the grounding continuity

Steel

Structured finish, epoxy polyester powder

RAL 7035 grey

IP55 according to IEC 60529 (with side panels and cable entry plates).

IK10 for plain door and IK08 for transparent door according to IEC 62262

Compliance with enclosure standard IEC 62208 and the RoHS and REACH directive

BV, DNV-GL, UL and cUL*, *1 door: 1, 3R, 12, 12K, *2 doors: 1, 3R, 12

1000 (2204.62) kg (lbs.)





- Side panels options, [page 108](#)
- Enclosure suites options, [page 109](#)
- Plinths, heights 100 (3.94) mm (in.) and 200 (7.87) mm (in.), [page 110](#)
- Cable gland plates, [page 116](#)
- Lifting systems, [page 120](#)
- Roof options, [page 122](#)
- Door accessories, [page 127](#)
- Other locking options, [page 130](#)
- Mounting plates and Telequick system, [page 245](#)

Suitable enclosures Spacial SF - supplied as kit

- Front door with a reinforcement frame (horizontal rails height-adjustable)
- The double-doors are overlapping, with system for fixing the left door
- Door reversible, 120° opening
- Rear panel to be screwed on with captive screws
- Removable roof delivered with top frame
- 4 locking points system with handle 5 (0.20) mm (in.) double-bar insert
- Mounting plate support brackets delivered with top and bottom frames kit (for widths from 600 (23.62) mm (in.))
- Mounting plate sliding rails delivered with top and bottom frames kit (for widths from 600 (23.62) mm (in.))
- 2 quick-fixing cross-rails delivered with top and bottom frames kit (for frames with widths from 600 (23.62) mm (in.) and depths from 500 (19.68) mm (in.))

- Uprights kit
- Top and bottom frames kit
- Rear panel kit
- Door kit (plain or transparent)

- Side panels options, [page 108](#)
- Enclosure suites options, [page 109](#)
- Plinths, heights 100 (3.94) mm (in.) and 200 (7.87) mm (in.), [page 110](#)
- Cable gland plates, [page 116](#)
- Lifting systems, [page 120](#)
- Roof options, [page 122](#)
- Other locking options, [page 130](#)
- Mounting plates and Telequick system, [page 245](#)

Dimensions				Enclosures			Plinth (H 100 (3.94) mm (in.))	
Height mm (in.)	Width mm (in.)	Depth mm (in.)	Doors					
				Plain door, without mounting plate	Plain door, with mounting plate	Transparent door, without mounting plate	Front kit (corners + front panels)	Side panels, 2 u.
1200 (47.24)	800 (31.50)	300 (11.81)	1	NSYSM12830	NSYSM12830P	-	NSYSPPF8100	NSYSPS3100
1200 (47.24)	1000 (39.37)	300 (11.81)	2	NSYSM1210302D	NSYSM1210302DP	-	NSYSPPF10100	NSYSPS3100
1200 (47.24)	1200 (47.24)	400 (15.75)	2	NSYSM1212402D	NSYSM1212402DP	-	NSYSPPF12100	NSYSPS4100
1400 (55.12)	600 (23.62)	300 (11.81)	1	NSYSM14630	NSYSM14630P	-	NSYSPPF6100	NSYSPS3100
1400 (55.12)	600 (23.62)	400 (15.75)	1	NSYSM14640	NSYSM14640P	-	NSYSPPF6100	NSYSPS4100
1400 (55.12)	800 (31.50)	300 (11.81)	1	NSYSM14830	NSYSM14830P	-	NSYSPPF8100	NSYSPS3100
1400 (55.12)	800 (31.50)	400 (15.75)	1	NSYSM14840	NSYSM14840P	NSYSM14840T	NSYSPPF8100	NSYSPS4100
1400 (55.12)	1000 (39.37)	400 (15.75)	2	NSYSM1410402D	NSYSM1410402DP	-	NSYSPPF10100	NSYSPS4100
1400 (55.12)	1200 (47.24)	400 (15.75)	2	NSYSM1412402D	NSYSM1412402DP	-	NSYSPPF12100	NSYSPS4100
1600 (62.99)	600 (23.62)	300 (11.81)	1	NSYSM16630	NSYSM16630P	-	NSYSPPF6100	NSYSPS3100
1600 (62.99)	600 (23.62)	400 (15.75)	1	NSYSM16640	NSYSM16640P	NSYSM16640T	NSYSPPF6100	NSYSPS4100
1600 (62.99)	800 (31.50)	300 (11.81)	1	NSYSM16830	NSYSM16830P	NSYSM16830T	NSYSPPF8100	NSYSPS3100
1600 (62.99)	800 (31.50)	400 (15.75)	1	NSYSM16840	NSYSM16840P	NSYSM16840T	NSYSPPF8100	NSYSPS4100
1600 (62.99)	1000 (39.37)	300 (11.81)	2	NSYSM1610302D	NSYSM1610302DP	-	NSYSPPF10100	NSYSPS3100
1600 (62.99)	1000 (39.37)	400 (15.75)	2	NSYSM1610402D	NSYSM1610402DP	-	NSYSPPF10100	NSYSPS4100
1600 (62.99)	1200 (47.24)	300 (11.81)	2	NSYSM1612302D	NSYSM1612302DP	-	NSYSPPF12100	NSYSPS3100
1600 (62.99)	1200 (47.24)	400 (15.75)	2	NSYSM1612402D	NSYSM1612402DP	-	NSYSPPF12100	NSYSPS4100
1800 (70.87)	600 (23.62)	300 (11.81)	1	NSYSM18630	NSYSM18630P	-	NSYSPPF6100	NSYSPS3100
1800 (70.87)	600 (23.62)	400 (15.75)	1	NSYSM18640	NSYSM18640P	NSYSM18640T	NSYSPPF6100	NSYSPS4100
1800 (70.87)	600 (23.62)	500 (19.68)	1	NSYSM18650	NSYSM18650P	-	NSYSPPF6100	NSYSPS5100
1800 (70.87)	800 (31.50)	300 (11.81)	1	NSYSM18830	NSYSM18830P	NSYSM18830T	NSYSPPF8100	NSYSPS3100
1800 (70.87)	800 (31.50)	400 (15.75)	1	NSYSM18840	NSYSM18840P	NSYSM18840T	NSYSPPF8100	NSYSPS4100
1800 (70.87)	800 (31.50)	500 (19.68)	1	NSYSM18850	NSYSM18850P	NSYSM18850T	NSYSPPF8100	NSYSPS5100
1800 (70.87)	800 (31.50)	600 (23.62)	1	NSYSM18860	NSYSM18860P	-	NSYSPPF8100	NSYSPS6100
1800 (70.87)	1000 (39.37)	400 (15.75)	1	NSYSM181040	NSYSM181040P	-	NSYSPPF10100	NSYSPS4100
1800 (70.87)	1000 (39.37)	400 (15.75)	2	NSYSM1810402D	NSYSM1810402DP	-	NSYSPPF10100	NSYSPS4100
1800 (70.87)	1000 (39.37)	500 (19.68)	2	NSYSM1810502D	NSYSM1810502DP	-	NSYSPPF10100	NSYSPS5100
1800 (70.87)	1200 (47.24)	400 (15.75)	2	NSYSM1812402D	NSYSM1812402DP	-	NSYSPPF12100	NSYSPS4100
1800 (70.87)	1200 (47.24)	500 (19.68)	2	NSYSM1812502D	NSYSM1812502DP	-	NSYSPPF12100	NSYSPS5100
1800 (70.87)	1600 (62.99)	400 (15.75)	2	NSYSM1816402D	NSYSM1816402DP	-	NSYSPPF16100	NSYSPS4100
1800 (70.87)	1600 (62.99)	500 (19.68)	2	NSYSM1816502D	NSYSM1816502DP	-	NSYSPPF16100	NSYSPS5100
2000 (78.74)	600 (23.62)	300 (11.81)	1	NSYSM20630	NSYSM20630P	-	NSYSPPF6100	NSYSPS3100
2000 (78.74)	600 (23.62)	400 (15.75)	1	NSYSM20640	NSYSM20640P	NSYSM20640T	NSYSPPF6100	NSYSPS4100
2000 (78.74)	600 (23.62)	500 (19.68)	1	NSYSM20650	NSYSM20650P	-	NSYSPPF6100	NSYSPS5100
2000 (78.74)	800 (31.50)	300 (11.81)	1	NSYSM20830	NSYSM20830P	NSYSM20830T	NSYSPPF8100	NSYSPS3100
2000 (78.74)	800 (31.50)	400 (15.75)	1	NSYSM20840	NSYSM20840P	NSYSM20840T	NSYSPPF8100	NSYSPS4100
2000 (78.74)	800 (31.50)	500 (19.68)	1	NSYSM20850	NSYSM20850P	NSYSM20850T	NSYSPPF8100	NSYSPS5100
2000 (78.74)	800 (31.50)	600 (23.62)	1	NSYSM20860	NSYSM20860P	NSYSM20860T	NSYSPPF8100	NSYSPS6100
2000 (78.74)	1000 (39.37)	400 (15.75)	2	NSYSM2010402D	NSYSM2010402DP	-	NSYSPPF10100	NSYSPS4100
2000 (78.74)	1000 (39.37)	500 (19.68)	2	NSYSM2010502D	NSYSM2010502DP	-	NSYSPPF10100	NSYSPS5100
2000 (78.74)	1200 (47.24)	400 (15.75)	2	NSYSM2012402D	NSYSM2012402DP	-	NSYSPPF12100	NSYSPS4100
2000 (78.74)	1200 (47.24)	500 (19.68)	2	NSYSM2012502D	NSYSM2012502DP	-	NSYSPPF12100	NSYSPS5100
2000 (78.74)	1200 (47.24)	600 (23.62)	2	NSYSM2012602D	NSYSM2012602DP	-	NSYSPPF12100	NSYSPS6100
2000 (78.74)	1600 (62.99)	400 (15.75)	2	NSYSM2016402D	NSYSM2016402DP	-	NSYSPPF16100	NSYSPS4100
2000 (78.74)	1600 (62.99)	500 (19.68)	2	NSYSM2016502D	NSYSM2016502DP	-	NSYSPPF16100	NSYSPS5100
2000 (78.74)	1600 (62.99)	600 (23.62)	2	NSYSM2016602D	NSYSM2016602DP	-	NSYSPPF16100	NSYSPS6100

Technical changes reserved. Information provided without guarantee. Images are for illustrative purposes only.

Plinth (H 200 (7.87) mm (in.))		Inner door	Mounting plate	Vertical uprights		19" swing rack	
Front kit (corners + front panels)	Side panels, 4 u.	Plain door	Galvanized	Standard	Technical	Off-center	Centered
NSYSPF8200	NSYSPS3200	-	NSYMP128	-	NSYTVR12	-	-
NSYSPF10200	NSYSPS3200	-	NSYMP1210	-	NSYTVR12	-	-
NSYSPF12200	NSYSPS4200	-	NSYMP1212	-	NSYTVR12	-	-
NSYSPF6200	NSYSPS3200	-	NSYMP146	-	NSYTVR14	-	-
NSYSPF6200	NSYSPS4200	-	NSYMP146	-	NSYTVR14	-	-
NSYSPF8200	NSYSPS3200	-	NSYMP148	-	NSYTVR14	NSYRSW27	NSYRSWC27
NSYSPF8200	NSYSPS4200	-	NSYMP148	-	NSYTVR14	NSYRSW27	NSYRSWC27
NSYSPF10200	NSYSPS4200	-	NSYMP1410	-	NSYTVR14	-	-
NSYSPF12200	NSYSPS4200	-	NSYMP1412	-	NSYTVR14	-	-
NSYSPF6200	NSYSPS3200	NSYID166	NSYMP166	-	NSYTVR16	-	-
NSYSPF6200	NSYSPS4200	NSYID166	NSYMP166	-	NSYTVR16	-	-
NSYSPF8200	NSYSPS3200	NSYID168	NSYMP168	-	NSYTVR16	NSYRSW31	NSYRSWC31
NSYSPF8200	NSYSPS4200	NSYID168	NSYMP168	-	NSYTVR16	NSYRSW31	NSYRSWC31
NSYSPF10200	NSYSPS3200	-	NSYMP1610	-	NSYTVR16	-	-
NSYSPF10200	NSYSPS4200	-	NSYMP1610	-	NSYTVR16	-	-
NSYSPF12200	NSYSPS3200	-	NSYMP1612	-	NSYTVR16	-	-
NSYSPF12200	NSYSPS4200	-	NSYMP1612	-	NSYTVR16	-	-
NSYSPF6200	NSYSPS3200	NSYID186	NSYMP186	NSYVR18	NSYTVR18	-	-
NSYSPF6200	NSYSPS4200	NSYID186	NSYMP186	NSYVR18	NSYTVR18	-	-
NSYSPF6200	NSYSPS5200	NSYID186	NSYMP186	NSYVR18	NSYTVR18	-	-
NSYSPF8200	NSYSPS3200	NSYID188	NSYMP188	NSYVR18	NSYTVR18	NSYRSW36	NSYRSWC36
NSYSPF8200	NSYSPS4200	NSYID188	NSYMP188	NSYVR18	NSYTVR18	NSYRSW36	NSYRSWC36
NSYSPF8200	NSYSPS5200	NSYID188	NSYMP188	NSYVR18	NSYTVR18	NSYRSW36	NSYRSWC36
NSYSPF8200	NSYSPS6200	NSYID188	NSYMP188	NSYVR18	NSYTVR18	NSYRSW36	NSYRSWC36
NSYSPF10200	NSYSPS4200	NSYID1810	NSYMP1810	NSYVR18	NSYTVR18	-	-
NSYSPF10200	NSYSPS4200	NSYID1810	NSYMP1810	NSYVR18	NSYTVR18	-	-
NSYSPF10200	NSYSPS5200	NSYID1810	NSYMP1810	NSYVR18	NSYTVR18	-	-
NSYSPF12200	NSYSPS4200	-	NSYMP1812	NSYVR18	NSYTVR18	-	-
NSYSPF12200	NSYSPS5200	-	NSYMP1812	NSYVR18	NSYTVR18	-	-
NSYSPF16200	NSYSPS4200	-	NSYMP1816	NSYVR18	NSYTVR18	-	-
NSYSPF16200	NSYSPS5200	-	NSYMP1816	NSYVR18	NSYTVR18	-	-
NSYSPF6200	NSYSPS3200	NSYID206	NSYMP206	NSYVR20	NSYTVR20	-	-
NSYSPF6200	NSYSPS4200	NSYID206	NSYMP206	NSYVR20	NSYTVR20	-	-
NSYSPF6200	NSYSPS5200	NSYID206	NSYMP206	NSYVR20	NSYTVR20	-	-
NSYSPF8200	NSYSPS3200	NSYID208	NSYMP208	NSYVR20	NSYTVR20	NSYRSW40	NSYRSWC40
NSYSPF8200	NSYSPS4200	NSYID208	NSYMP208	NSYVR20	NSYTVR20	NSYRSW40	NSYRSWC40
NSYSPF8200	NSYSPS5200	NSYID208	NSYMP208	NSYVR20	NSYTVR20	NSYRSW40	NSYRSWC40
NSYSPF8200	NSYSPS6200	NSYID208	NSYMP208	NSYVR20	NSYTVR20	NSYRSW40	NSYRSWC40
NSYSPF10200	NSYSPS4200	NSYID2010	NSYMP2010	NSYVR20	NSYTVR20	-	-
NSYSPF10200	NSYSPS5200	NSYID2010	NSYMP2010	NSYVR20	NSYTVR20	-	-
NSYSPF12200	NSYSPS4200	-	NSYMP2012	NSYVR20	NSYTVR20	-	-
NSYSPF12200	NSYSPS5200	-	NSYMP2012	NSYVR20	NSYTVR20	-	-
NSYSPF12200	NSYSPS6200	-	NSYMP2012	NSYVR20	NSYTVR20	-	-
NSYSPF16200	NSYSPS4200	-	NSYMP2016	NSYVR20	NSYTVR20	-	-
NSYSPF16200	NSYSPS5200	-	NSYMP2016	NSYVR20	NSYTVR20	-	-
NSYSPF16200	NSYSPS6200	-	NSYMP2016	NSYVR20	NSYTVR20	-	-

Technical changes reserved. Information provided without guarantee. Images are for illustrative purposes only.

Dimensions			Enclosures				Side panels	Cable entry plates		
(A)	(B)	(C)	Doors	Plain door, without mounting plate	Plain door, with mounting plate	Transparent door, without mounting plate	Standard	Plain	1 entry	2 entries
Height mm (in.)	Width mm (in.)	Depth mm (in.)								
1200 (47.24)	600 (23.62)	400 (15.75)	1	NSYSF12640	NSYSF12640P	-	NSY2SP124	NSYEC64	NSYEC641	-
1200 (47.24)	600 (23.62)	600 (23.62)	1	NSYSF12660	NSYSF12660P	-	NSY2SP126	NSYEC66	NSYEC661	NSYEC662
1200 (47.24)	800 (31.50)	400 (15.75)	1	NSYSF12840	NSYSF12840P	-	NSY2SP124	NSYEC84	NSYEC841	-
1200 (47.24)	800 (31.50)	600 (23.62)	1	NSYSF12860	NSYSF12860P	-	NSY2SP126	NSYEC86	NSYEC861	NSYEC862
1400 (55.12)	600 (23.62)	400 (15.75)	1	NSYSF14640	NSYSF14640P	-	NSY2SP144	NSYEC64	NSYEC641	-
1400 (55.12)	800 (31.50)	400 (15.75)	1	NSYSF14840	NSYSF14840P	-	NSY2SP144	NSYEC84	NSYEC841	-
1600 (62.99)	600 (23.62)	600 (23.62)	1	NSYSF16660	NSYSF16660P	-	NSY2SP166	NSYEC66	NSYEC661	NSYEC662
1600 (62.99)	600 (23.62)	800 (31.50)	1	NSYSF16680	NSYSF16680P	-	NSY2SP168	NSYEC68	NSYEC681	NSYEC682
1600 (62.99)	800 (31.50)	600 (23.62)	1	NSYSF16860	NSYSF16860P	-	NSY2SP166	NSYEC86	NSYEC861	NSYEC862
1600 (62.99)	800 (31.50)	800 (31.50)	1	NSYSF16880	NSYSF16880P	-	NSY2SP168	NSYEC88	NSYEC881	NSYEC882
1800 (70.87)	400 (15.75)	400 (15.75)	1	NSYSF18440	-	-	NSY2SP184	NSYEC44	NSYEC441	-
1800 (70.87)	400 (15.75)	500 (19.68)	1	NSYSF18450	-	-	NSY2SP185	NSYEC45	NSYEC451	-
1800 (70.87)	400 (15.75)	600 (23.62)	1	NSYSF18460	-	-	NSY2SP186	-	NSYEC461	NSYEC462
1800 (70.87)	600 (23.62)	400 (15.75)	1	NSYSF18640	NSYSF18640P	NSYSF18640T	NSY2SP184	NSYEC64	NSYEC641	-
1800 (70.87)	600 (23.62)	500 (19.68)	1	NSYSF18650	NSYSF18650P	NSYSF18650T	NSY2SP185	NSYEC65	NSYEC651	-
1800 (70.87)	600 (23.62)	600 (23.62)	1	NSYSF18660	NSYSF18660P	-	NSY2SP186	NSYEC66	NSYEC661	NSYEC662
1800 (70.87)	600 (23.62)	800 (31.50)	1	-	-	NSYSF18680T	NSY2SP188	NSYEC68	NSYEC681	NSYEC682
1800 (70.87)	800 (31.50)	400 (15.75)	1	NSYSF18840	NSYSF18840P	NSYSF18840T	NSY2SP184	NSYEC84	NSYEC841	-
1800 (70.87)	800 (31.50)	500 (19.68)	1	NSYSF18850	NSYSF18850P	NSYSF18850T	NSY2SP185	NSYEC85	NSYEC851	-
1800 (70.87)	800 (31.50)	600 (23.62)	1	NSYSF18860	NSYSF18860P	NSYSF18860T	NSY2SP186	NSYEC86	NSYEC861	NSYEC862
1800 (70.87)	800 (31.50)	600 (23.62)	2	NSYSF188602D	NSYSF188602DP	-	NSY2SP186	NSYEC86	NSYEC861	NSYEC862
1800 (70.87)	1000 (39.37)	400 (15.75)	1	NSYSF181040	NSYSF181040P	-	NSY2SP184	NSYEC104	NSYEC1041	-
1800 (70.87)	1000 (39.37)	400 (15.75)	2	NSYSF1810402D	NSYSF1810402DP	-	NSY2SP184	NSYEC104	NSYEC1041	-
1800 (70.87)	1000 (39.37)	500 (19.68)	1	NSYSF181050	NSYSF181050P	-	NSY2SP185	NSYEC105	NSYEC1051	-
1800 (70.87)	1000 (39.37)	600 (23.62)	1	NSYSF181060	NSYSF181060P	-	NSY2SP186	NSYEC106	NSYEC1061	NSYEC1062
1800 (70.87)	1000 (39.37)	600 (23.62)	2	NSYSF1810602D	NSYSF1810602DP	-	NSY2SP186	NSYEC106	NSYEC1061	NSYEC1062
1800 (70.87)	1200 (47.24)	400 (15.75)	2	NSYSF1812402D	NSYSF1812402DP	-	NSY2SP184	NSYEC124	NSYEC1241	-
1800 (70.87)	1200 (47.24)	500 (19.68)	2	NSYSF1812502D	NSYSF1812502DP	-	NSY2SP185	NSYEC125	NSYEC1251	-
1800 (70.87)	1200 (47.24)	600 (23.62)	2	NSYSF1812602D	NSYSF1812602DP	-	NSY2SP186	NSYEC126	NSYEC1261	NSYEC1262
2000 (78.74)	300 (11.81)	500 (19.68)	1	NSYSF20350	-	-	NSY2SP205	NSYEC35	NSYEC351	-
2000 (78.74)	300 (11.81)	600 (23.62)	1	NSYSF20360	-	-	NSY2SP206	NSYEC36	NSYEC361	-
2000 (78.74)	300 (11.81)	800 (31.50)	1	NSYSF20380	-	-	NSY2SP208	-	NSYEC381	-
2000 (78.74)	400 (15.75)	400 (15.75)	1	NSYSF20440	-	-	NSY2SP204	NSYEC44	NSYEC441	-
2000 (78.74)	400 (15.75)	500 (19.68)	1	NSYSF20450	-	-	NSY2SP205	NSYEC45	NSYEC451	-
2000 (78.74)	400 (15.75)	600 (23.62)	1	NSYSF20460	-	-	NSY2SP206	NSYEC64	NSYEC461	NSYEC462
2000 (78.74)	400 (15.75)	800 (31.50)	1	NSYSF20480	-	-	NSY2SP208	NSYEC84	NSYEC481	NSYEC482
2000 (78.74)	600 (23.62)	400 (15.75)	1	NSYSF20640	NSYSF20640P	NSYSF20640T	NSY2SP204	NSYEC64	NSYEC641	-
2000 (78.74)	600 (23.62)	500 (19.68)	1	NSYSF20650	NSYSF20650P	NSYSF20650T	NSY2SP205	NSYEC65	NSYEC651	-
2000 (78.74)	600 (23.62)	600 (23.62)	1	NSYSF20660	NSYSF20660P	-	NSY2SP206	NSYEC66	NSYEC661	NSYEC662
2000 (78.74)	600 (23.62)	800 (31.50)	1	NSYSF20680	NSYSF20680P	-	NSY2SP208	NSYEC68	NSYEC681	NSYEC682
2000 (78.74)	800 (31.50)	400 (15.75)	1	NSYSF20840	NSYSF20840P	NSYSF20840T	NSY2SP204	NSYEC84	NSYEC841	-
2000 (78.74)	800 (31.50)	500 (19.68)	1	NSYSF20850	NSYSF20850P	NSYSF20850T	NSY2SP205	NSYEC85	NSYEC851	-
2000 (78.74)	800 (31.50)	600 (23.62)	1	NSYSF20860	NSYSF20860P	NSYSF20860T	NSY2SP206	NSYEC86	NSYEC861	NSYEC862
2000 (78.74)	800 (31.50)	600 (23.62)	2	NSYSF208602D	NSYSF208602DP	-	NSY2SP206	NSYEC86	NSYEC861	NSYEC862
2000 (78.74)	800 (31.50)	800 (31.50)	1	NSYSF20880	NSYSF20880P	NSYSF20880T	NSY2SP208	NSYEC88	NSYEC881	NSYEC882
2000 (78.74)	1000 (39.37)	400 (15.75)	1	NSYSF201040	NSYSF201040P	NSYSF201040T	NSY2SP204	NSYEC104	NSYEC1041	-
2000 (78.74)	1000 (39.37)	400 (15.75)	2	NSYSF2010402D	NSYSF2010402DP	-	NSY2SP204	NSYEC104	NSYEC1041	-
2000 (78.74)	1000 (39.37)	500 (19.68)	1	NSYSF201050	NSYSF201050P	NSYSF201050T	NSY2SP205	NSYEC105	NSYEC1051	-
2000 (78.74)	1000 (39.37)	500 (19.68)	2	NSYSF2010502D	NSYSF2010502DP	-	NSY2SP205	NSYEC105	NSYEC1051	-
2000 (78.74)	1000 (39.37)	600 (23.62)	1	NSYSF201060	NSYSF201060P	NSYSF201060T	NSY2SP206	NSYEC106	NSYEC1061	NSYEC1062
2000 (78.74)	1000 (39.37)	600 (23.62)	2	NSYSF2010602D	NSYSF2010602DP	-	NSY2SP206	NSYEC106	NSYEC1061	NSYEC1062
2000 (78.74)	1000 (39.37)	800 (31.496)	1	NSYSF201080	NSYSF201080P	-	NSY2SP208	NSYEC108	NSYEC1081	NSYEC1082
2000 (78.74)	1200 (47.24)	400 (15.748)	2	NSYSF2012402D	NSYSF2012402DP	-	NSY2SP204	NSYEC124	NSYEC1241	-
2000 (78.74)	1200 (47.24)	500 (196.85)	2	NSYSF2012502D	NSYSF2012502DP	-	NSY2SP205	NSYEC125	NSYEC1251	-
2000 (78.74)	1200 (47.24)	600 (236.22)	2	NSYSF2012602D	NSYSF2012602DP	-	NSY2SP206	NSYEC126	NSYEC1261	NSYEC1262
2000 (78.74)	1200 (47.24)	800 (314.96)	2	NSYSF2012802D	NSYSF2012802DP	-	NSY2SP208	NSYEC128	NSYEC1281	NSYEC1282
2000 (78.74)	1600 (629.92)	400 (157.48)	2	NSYSF2016402D	NSYSF2016402DP	-	NSY2SP204	NSYEC164	NSYEC1641	-
2000 (78.74)	1600 (629.92)	500 (196.85)	2	NSYSF2016502D	NSYSF2016502DP	-	NSY2SP205	NSYEC165	NSYEC1651	-
2000 (78.74)	1600 (629.92)	600 (236.22)	2	NSYSF2016602D	NSYSF2016602DP	-	NSY2SP206	NSYEC166	NSYEC1661	NSYEC1662
2200 (866.14)	400 (157.48)	600 (236.22)	1	NSYSF22460	-	-	NSY2SP226	-	NSYEC461	-
2200 (866.14)	600 (236.22)	600 (236.22)	1	NSYSF22660	NSYSF22660P	-	NSY2SP226	NSYEC66	NSYEC661	NSYEC662
2200 (866.14)	600 (236.22)	800 (314.96)	1	NSYSF22680	NSYSF22680P	-	NSY2SP228	NSYEC68	NSYEC681	NSYEC682
2200 (866.14)	800 (314.96)	600 (236.22)	1	NSYSF22860	NSYSF22860P	-	NSY2SP226	NSYEC86	NSYEC861	NSYEC862
2200 (866.14)	800 (314.96)	800 (314.96)	1	NSYSF22880	NSYSF22880P	NSYSF22880T	NSY2SP228	NSYEC88	NSYEC881	NSYEC882
2200 (866.14)	1000 (393.70)	600 (236.22)	1	NSYSF221060	NSYSF221060P	-	NSY2SP226	NSYEC106	NSYEC1061	NSYEC1062
2200 (866.14)	1200 (472.44)	600 (236.22)	2	NSYSF2212602D	NSYSF2212602DP	-	NSY2SP226	NSYEC126	NSYEC1261	NSYEC1262
2200 (866.14)	1200 (472.44)	800 (314.96)	2	NSYSF2212802D	NSYSF2212802DP	-	NSY2SP228	NSYEC128	NSYEC1281	NSYEC1282

Technical changes reserved. Information provided without guarantee. Images are for illustrative purposes only.

Plinth (H 100 (39.37) mm (in.))		Plinth (H 200 (78.74) mm (in.))		Mounting plates		Vertical uprights	
Front kit (corners + front panels)	Side panels, 2 u.	Front kit (corners + front panels)	Side panels, 4 u.	Mounting plate	Intermediate mounting plate	Standard	Technical
NSYSPF6100	NSYSPS4100	NSYSPF6200	NSYSPS4200	NSYMP126	NSYSIMP12	-	NSYTVR12
NSYSPF6100	NSYSPS6100	NSYSPF6200	NSYSPS6200	NSYMP126	NSYSIMP12	-	NSYTVR12
NSYSPF8100	NSYSPS4100	NSYSPF8200	NSYSPS4200	NSYMP128	NSYSIMP12	-	NSYTVR12
NSYSPF8100	NSYSPS6100	NSYSPF8200	NSYSPS6200	NSYMP128	NSYSIMP12	-	NSYTVR12
NSYSPF6100	NSYSPS4100	NSYSPF6200	NSYSPS4200	NSYMP146	NSYSIMP14	-	NSYTVR14
NSYSPF8100	NSYSPS4100	NSYSPF8200	NSYSPS4200	NSYMP148	NSYSIMP14	-	NSYTVR14
NSYSPF6100	NSYSPS6100	NSYSPF6200	NSYSPS6200	NSYMP166	NSYSIMP16	-	NSYTVR16
NSYSPF6100	NSYSPS8100	NSYSPF6200	NSYSPS8200	NSYMP166	NSYSIMP16	-	NSYTVR16
NSYSPF8100	NSYSPS6100	NSYSPF8200	NSYSPS6200	NSYMP168	NSYSIMP16	-	NSYTVR16
NSYSPF8100	NSYSPS8100	NSYSPF8200	NSYSPS8200	NSYMP168	NSYSIMP16	-	NSYTVR16
NSYSPF4100	NSYSPS4100	NSYSPF4200	NSYSPS4200	NSYMP184	NSYSIMP18	NSYVR18	NSYTVR18
NSYSPF4100	NSYSPS5100	NSYSPF4200	NSYSPS5200	NSYMP184	NSYSIMP18	NSYVR18	NSYTVR18
NSYSPF4100	NSYSPS6100	NSYSPF4200	NSYSPS6200	NSYMP184	NSYSIMP18	NSYVR18	NSYTVR18
NSYSPF6100	NSYSPS4100	NSYSPF6200	NSYSPS4200	NSYMP186	NSYSIMP18	NSYVR18	NSYTVR18
NSYSPF6100	NSYSPS5100	NSYSPF6200	NSYSPS5200	NSYMP186	NSYSIMP18	NSYVR18	NSYTVR18
NSYSPF6100	NSYSPS6100	NSYSPF6200	NSYSPS6200	NSYMP186	NSYSIMP18	NSYVR18	NSYTVR18
NSYSPF6100	NSYSPS8100	NSYSPF6200	NSYSPS8200	NSYMP186	NSYSIMP18	NSYVR18	NSYTVR18
NSYSPF8100	NSYSPS4100	NSYSPF8200	NSYSPS4200	NSYMP188	NSYSIMP18	NSYVR18	NSYTVR18
NSYSPF8100	NSYSPS5100	NSYSPF8200	NSYSPS5200	NSYMP188	NSYSIMP18	NSYVR18	NSYTVR18
NSYSPF8100	NSYSPS6100	NSYSPF8200	NSYSPS6200	NSYMP188	NSYSIMP18	NSYVR18	NSYTVR18
NSYSPF8100	NSYSPS8100	NSYSPF8200	NSYSPS8200	NSYMP188	NSYSIMP18	NSYVR18	NSYTVR18
NSYSPF10100	NSYSPS4100	NSYSPF10200	NSYSPS4200	NSYMP1810	NSYSIMP18	NSYVR18	NSYTVR18
NSYSPF10100	NSYSPS4100	NSYSPF10200	NSYSPS4200	NSYMP1810	NSYSIMP18	NSYVR18	NSYTVR18
NSYSPF10100	NSYSPS5100	NSYSPF10200	NSYSPS5200	NSYMP1810	NSYSIMP18	NSYVR18	NSYTVR18
NSYSPF10100	NSYSPS6100	NSYSPF10200	NSYSPS6200	NSYMP1810	NSYSIMP18	NSYVR18	NSYTVR18
NSYSPF10100	NSYSPS6100	NSYSPF10200	NSYSPS6200	NSYMP1810	NSYSIMP18	NSYVR18	NSYTVR18
NSYSPF12100	NSYSPS4100	NSYSPF12200	NSYSPS4200	NSYMP1812	NSYSIMP18	NSYVR18	NSYTVR18
NSYSPF12100	NSYSPS5100	NSYSPF12200	NSYSPS5200	NSYMP1812	NSYSIMP18	NSYVR18	NSYTVR18
NSYSPF12100	NSYSPS6100	NSYSPF12200	NSYSPS6200	NSYMP1812	NSYSIMP18	NSYVR18	NSYTVR18
NSYSPF3100	NSYSPS5100	NSYSPF3200	NSYSPS5200	-	-	NSYVR20	NSYTVR20
NSYSPF3100	NSYSPS6100	NSYSPF3200	NSYSPS6200	-	-	NSYVR20	NSYTVR20
NSYSPF3100	NSYSPS8100	NSYSPF3200	NSYSPS8200	-	-	NSYVR20	NSYTVR20
NSYSPF4100	NSYSPS4100	NSYSPF4200	NSYSPS4200	NSYMP204	NSYSIMP20	NSYVR20	NSYTVR20
NSYSPF4100	NSYSPS5100	NSYSPF4200	NSYSPS5200	NSYMP204	NSYSIMP20	NSYVR20	NSYTVR20
NSYSPF4100	NSYSPS6100	NSYSPF4200	NSYSPS6200	NSYMP204	NSYSIMP20	NSYVR20	NSYTVR20
NSYSPF4100	NSYSPS8100	NSYSPF4200	NSYSPS8200	NSYMP204	NSYSIMP20	NSYVR20	NSYTVR20
NSYSPF6100	NSYSPS4100	NSYSPF6200	NSYSPS4200	NSYMP206	NSYSIMP20	NSYVR20	NSYTVR20
NSYSPF6100	NSYSPS5100	NSYSPF6200	NSYSPS5200	NSYMP206	NSYSIMP20	NSYVR20	NSYTVR20
NSYSPF6100	NSYSPS6100	NSYSPF6200	NSYSPS6200	NSYMP206	NSYSIMP20	NSYVR20	NSYTVR20
NSYSPF6100	NSYSPS8100	NSYSPF6200	NSYSPS8200	NSYMP206	NSYSIMP20	NSYVR20	NSYTVR20
NSYSPF8100	NSYSPS4100	NSYSPF8200	NSYSPS4200	NSYMP208	NSYSIMP20	NSYVR20	NSYTVR20
NSYSPF8100	NSYSPS5100	NSYSPF8200	NSYSPS5200	NSYMP208	NSYSIMP20	NSYVR20	NSYTVR20
NSYSPF8100	NSYSPS6100	NSYSPF8200	NSYSPS6200	NSYMP208	NSYSIMP20	NSYVR20	NSYTVR20
NSYSPF8100	NSYSPS8100	NSYSPF8200	NSYSPS8200	NSYMP208	NSYSIMP20	NSYVR20	NSYTVR20
NSYSPF10100	NSYSPS4100	NSYSPF10200	NSYSPS4200	NSYMP2010	NSYSIMP20	NSYVR20	NSYTVR20
NSYSPF10100	NSYSPS4100	NSYSPF10200	NSYSPS4200	NSYMP2010	NSYSIMP20	NSYVR20	NSYTVR20
NSYSPF10100	NSYSPS5100	NSYSPF10200	NSYSPS5200	NSYMP2010	NSYSIMP20	NSYVR20	NSYTVR20
NSYSPF10100	NSYSPS5100	NSYSPF10200	NSYSPS5200	NSYMP2010	NSYSIMP20	NSYVR20	NSYTVR20
NSYSPF10100	NSYSPS6100	NSYSPF10200	NSYSPS6200	NSYMP2010	NSYSIMP20	NSYVR20	NSYTVR20
NSYSPF10100	NSYSPS6100	NSYSPF10200	NSYSPS6200	NSYMP2010	NSYSIMP20	NSYVR20	NSYTVR20
NSYSPF10100	NSYSPS8100	NSYSPF10200	NSYSPS8200	NSYMP2010	NSYSIMP20	NSYVR20	NSYTVR20
NSYSPF12100	NSYSPS4100	NSYSPF12200	NSYSPS4200	NSYMP2012	NSYSIMP20	NSYVR20	NSYTVR20
NSYSPF12100	NSYSPS5100	NSYSPF12200	NSYSPS5200	NSYMP2012	NSYSIMP20	NSYVR20	NSYTVR20
NSYSPF12100	NSYSPS6100	NSYSPF12200	NSYSPS6200	NSYMP2012	NSYSIMP20	NSYVR20	NSYTVR20
NSYSPF12100	NSYSPS8100	NSYSPF12200	NSYSPS8200	NSYMP2012	NSYSIMP20	NSYVR20	NSYTVR20
NSYSPF16100	NSYSPS4100	NSYSPF16200	NSYSPS4200	NSYMP2016	NSYSIMP20	NSYVR20	NSYTVR20
NSYSPF16100	NSYSPS5100	NSYSPF16200	NSYSPS5200	NSYMP2016	NSYSIMP20	NSYVR20	NSYTVR20
NSYSPF16100	NSYSPS6100	NSYSPF16200	NSYSPS6200	NSYMP2016	NSYSIMP20	NSYVR20	NSYTVR20
NSYSPF4100	NSYSPS6100	NSYSPF4200	NSYSPS6200	NSYMP224	NSYSIMP22	NSYVR22	NSYTVR22
NSYSPF6100	NSYSPS6100	NSYSPF6200	NSYSPS6200	NSYMP226	NSYSIMP22	NSYVR22	NSYTVR22
NSYSPF6100	NSYSPS8100	NSYSPF6200	NSYSPS8200	NSYMP226	NSYSIMP22	NSYVR22	NSYTVR22
NSYSPF8100	NSYSPS6100	NSYSPF8200	NSYSPS6200	NSYMP228	NSYSIMP22	NSYVR22	NSYTVR22
NSYSPF8100	NSYSPS8100	NSYSPF8200	NSYSPS8200	NSYMP228	NSYSIMP22	NSYVR22	NSYTVR22
NSYSPF10100	NSYSPS6100	NSYSPF10200	NSYSPS6200	NSYMP2210	NSYSIMP22	NSYVR22	NSYTVR22
NSYSPF12100	NSYSPS6100	NSYSPF12200	NSYSPS6200	NSYMP2212	NSYSIMP22	NSYVR22	NSYTVR22
NSYSPF12100	NSYSPS8100	NSYSPF12200	NSYSPS8200	NSYMP2212	NSYSIMP22	NSYVR22	NSYTVR22

Technical changes reserved. Information provided without guarantee. Images are for illustrative purposes only.

Dimensions			Doors	Vertical uprights	Bottom frame and top frame with roof	Panels		Doors		Mounting plate
(A) Height mm (in.)	(B) Width mm (in.)	(C) Depth mm (in.)		Standard	Frames	Rear panel	Side panel	Plain	Transparent	Standard
1200 (47.24)	600 (23.62)	400 (15.75)	1	NSYSFV12	NSYSFC64	NSYBP126	NSY2SP124	NSYSFD126	NSYSFD126T	NSYMP126
1200 (47.24)	600 (23.62)	500 (19.68)	1	NSYSFV12	NSYSFC65	NSYBP126	NSY2SP125	NSYSFD126	NSYSFD126T	NSYMP126
1200 (47.24)	600 (23.62)	600 (23.62)	1	NSYSFV12	NSYSFC66	NSYBP126	NSY2SP126	NSYSFD126	NSYSFD126T	NSYMP126
1200 (47.24)	600 (23.62)	800 (31.50)	1	NSYSFV12	NSYSFC68	NSYBP126	NSY2SP128	NSYSFD126	NSYSFD126T	NSYMP126
1200 (47.24)	800 (31.50)	400 (15.75)	1	NSYSFV12	NSYSFC84	NSYBP128	NSY2SP124	NSYSFD128	NSYSFD128T	NSYMP128
1200 (47.24)	800 (31.50)	500 (19.68)	1	NSYSFV12	NSYSFC85	NSYBP128	NSY2SP125	NSYSFD128	NSYSFD128T	NSYMP128
1200 (47.24)	800 (31.50)	600 (23.62)	1	NSYSFV12	NSYSFC86	NSYBP128	NSY2SP126	NSYSFD128	NSYSFD128T	NSYMP128
1200 (47.24)	800 (31.50)	800 (31.50)	1	NSYSFV12	NSYSFC88	NSYBP128	NSY2SP128	NSYSFD128	NSYSFD128T	NSYMP128
1400 (55.12)	600 (23.62)	400 (15.75)	1	NSYSFV14	NSYSFC64	NSYBP146	NSY2SP144	NSYSFD146	NSYSFD146T	NSYMP146
1400 (55.12)	600 (23.62)	500 (19.68)	1	NSYSFV14	NSYSFC65	NSYBP146	NSY2SP145	NSYSFD146	NSYSFD146T	NSYMP146
1400 (55.12)	600 (23.62)	600 (23.62)	1	NSYSFV14	NSYSFC66	NSYBP146	NSY2SP146	NSYSFD146	NSYSFD146T	NSYMP146
1400 (55.12)	600 (23.62)	800 (31.50)	1	NSYSFV14	NSYSFC68	NSYBP146	NSY2SP148	NSYSFD146	NSYSFD146T	NSYMP146
1400 (55.12)	800 (31.50)	400 (15.75)	1	NSYSFV14	NSYSFC84	NSYBP148	NSY2SP144	NSYSFD148	NSYSFD148T	NSYMP148
1400 (55.12)	800 (31.50)	500 (19.68)	1	NSYSFV14	NSYSFC85	NSYBP148	NSY2SP145	NSYSFD148	NSYSFD148T	NSYMP148
1400 (55.12)	800 (31.50)	600 (23.62)	1	NSYSFV14	NSYSFC86	NSYBP148	NSY2SP146	NSYSFD148	NSYSFD148T	NSYMP148
1400 (55.12)	800 (31.50)	800 (31.50)	1	NSYSFV14	NSYSFC88	NSYBP148	NSY2SP148	NSYSFD148	NSYSFD148T	NSYMP148
1600 (62.99)	600 (23.62)	400 (15.75)	1	NSYSFV16	NSYSFC64	NSYBP166	NSY2SP164	NSYSFD166	NSYSFD166T	NSYMP166
1600 (62.99)	600 (23.62)	500 (19.68)	1	NSYSFV16	NSYSFC65	NSYBP166	NSY2SP165	NSYSFD166	NSYSFD166T	NSYMP166
1600 (62.99)	600 (23.62)	600 (23.62)	1	NSYSFV16	NSYSFC66	NSYBP166	NSY2SP166	NSYSFD166	NSYSFD166T	NSYMP166
1600 (62.99)	600 (23.62)	800 (31.50)	1	NSYSFV16	NSYSFC68	NSYBP166	NSY2SP168	NSYSFD166	NSYSFD166T	NSYMP166
1600 (62.99)	800 (31.50)	400 (15.75)	1	NSYSFV16	NSYSFC84	NSYBP168	NSY2SP164	NSYSFD168	NSYSFD168T	NSYMP168
1600 (62.99)	800 (31.50)	500 (19.68)	1	NSYSFV16	NSYSFC85	NSYBP168	NSY2SP165	NSYSFD168	NSYSFD168T	NSYMP168
1600 (62.99)	800 (31.50)	600 (23.62)	1	NSYSFV16	NSYSFC86	NSYBP168	NSY2SP166	NSYSFD168	NSYSFD168T	NSYMP168
1600 (62.99)	800 (31.50)	800 (31.50)	1	NSYSFV16	NSYSFC88	NSYBP168	NSY2SP168	NSYSFD168	NSYSFD168T	NSYMP168
1800 (70.87)	400 (15.75)	400 (15.75)	1	NSYSFV18	NSYSFC44	NSYBP184	NSY2SP184	NSYSFD184	-	NSYMP184 New
1800 (70.87)	400 (15.75)	500 (19.68)	1	NSYSFV18	NSYSFC45	NSYBP184	NSY2SP185	NSYSFD184	-	NSYMP184 New
1800 (70.87)	400 (15.75)	600 (23.62)	1	NSYSFV18	NSYSFC46	NSYBP184	NSY2SP186	NSYSFD184	-	NSYMP184 New
1800 (70.87)	400 (15.75)	800 (31.50)	1	NSYSFV18	NSYSFC48	NSYBP184	NSY2SP188	NSYSFD184	-	NSYMP184 New
1800 (70.87)	600 (23.62)	400 (15.75)	1	NSYSFV18	NSYSFC64	NSYBP186	NSY2SP184	NSYSFD186	NSYSFD186T	NSYMP186
1800 (70.87)	600 (23.62)	500 (19.68)	1	NSYSFV18	NSYSFC65	NSYBP186	NSY2SP185	NSYSFD186	NSYSFD186T	NSYMP186
1800 (70.87)	600 (23.62)	600 (23.62)	1	NSYSFV18	NSYSFC66	NSYBP186	NSY2SP186	NSYSFD186	NSYSFD186T	NSYMP186
1800 (70.87)	600 (23.62)	800 (31.50)	1	NSYSFV18	NSYSFC68	NSYBP186	NSY2SP188	NSYSFD186	NSYSFD186T	NSYMP186
1800 (70.87)	800 (31.50)	400 (15.75)	1	NSYSFV18	NSYSFC84	NSYBP188	NSY2SP184	NSYSFD188	NSYSFD188T	NSYMP188
1800 (70.87)	800 (31.50)	500 (19.68)	1	NSYSFV18	NSYSFC85	NSYBP188	NSY2SP185	NSYSFD188	NSYSFD188T	NSYMP188
1800 (70.87)	800 (31.50)	600 (23.62)	1	NSYSFV18	NSYSFC86	NSYBP188	NSY2SP186	NSYSFD188	NSYSFD188T	NSYMP188
1800 (70.87)	800 (31.50)	800 (31.50)	2	NSYSFV18	NSYSFC86	NSYBP188	NSY2SP186	NSYSFD1882D	-	NSYMP188
1800 (70.87)	800 (31.50)	800 (31.50)	1	NSYSFV18	NSYSFC88	NSYBP188	NSY2SP188	NSYSFD188	NSYSFD188T	NSYMP188
1800 (70.87)	800 (31.50)	800 (31.50)	2	NSYSFV18	NSYSFC88	NSYBP188	NSY2SP188	NSYSFD1882D	-	NSYMP188
1800 (70.87)	1000 (39.37)	400 (15.75)	1	NSYSFV18	NSYSFC104	NSYBP1810	NSY2SP184	NSYSFD1810	NSYSFD1810T	NSYMP1810
1800 (70.87)	1000 (39.37)	400 (15.75)	2	NSYSFV18	NSYSFC104	NSYBP1810	NSY2SP184	NSYSFD18102D	-	NSYMP1810
1800 (70.87)	1000 (39.37)	500 (19.68)	1	NSYSFV18	NSYSFC105	NSYBP1810	NSY2SP185	NSYSFD1810	NSYSFD1810T	NSYMP1810
1800 (70.87)	1000 (39.37)	600 (23.62)	1	NSYSFV18	NSYSFC106	NSYBP1810	NSY2SP186	NSYSFD1810	NSYSFD1810T	NSYMP1810
1800 (70.87)	1000 (39.37)	600 (23.62)	2	NSYSFV18	NSYSFC106	NSYBP1810	NSY2SP186	NSYSFD18102D	-	NSYMP1810
1800 (70.87)	1000 (39.37)	800 (31.50)	1	NSYSFV18	NSYSFC108	NSYBP1810	NSY2SP188	NSYSFD1810	NSYSFD1810T	NSYMP1810
1800 (70.87)	1000 (39.37)	800 (31.50)	2	NSYSFV18	NSYSFC108	NSYBP1810	NSY2SP188	NSYSFD18102D	-	NSYMP1810
1800 (70.87)	1200 (47.24)	400 (15.75)	2	NSYSFV18	NSYSFC124	NSYBP1812	NSY2SP184	NSYSFD18122D	NSYSFD18122DT	NSYMP1812
1800 (70.87)	1200 (47.24)	500 (19.68)	2	NSYSFV18	NSYSFC125	NSYBP1812	NSY2SP185	NSYSFD18122D	NSYSFD18122DT	NSYMP1812
1800 (70.87)	1200 (47.24)	600 (23.62)	2	NSYSFV18	NSYSFC126	NSYBP1812	NSY2SP186	NSYSFD18122D	NSYSFD18122DT	NSYMP1812
1800 (70.87)	1200 (47.24)	800 (31.50)	2	NSYSFV18	NSYSFC128	NSYBP1812	NSY2SP188	NSYSFD18122D	NSYSFD18122DT	NSYMP1812



Dimensions			Vertical uprights	Bottom frame and top frame with roof	Panels		Doors		Mounting plate	
(A) Height mm (in.)	(B) Width mm (in.)	(C) Depth mm (in.)	Doors	Standard	Frames	Rear panel	Side panel	Plain	Transparent	Standard
2000 (78.74)	300 (11.81)	500 (19.68)	1	NSYSFV20	NSYSFC35	NSYBP203	NSY2SP205	NSYSFD203	-	-
2000 (78.74)	300 (11.81)	600 (23.62)	1	NSYSFV20	NSYSFC36	NSYBP203	NSY2SP206	NSYSFD203	-	-
2000 (78.74)	300 (11.81)	800 (31.50)	1	NSYSFV20	NSYSFC38	NSYBP203	NSY2SP208	NSYSFD203	-	-
2000 (78.74)	400 (15.75)	400 (15.75)	1	NSYSFV20	NSYSFC44	NSYBP204	NSY2SP204	NSYSFD204	-	NSYMP204
2000 (78.74)	400 (15.75)	500 (19.68)	1	NSYSFV20	NSYSFC45	NSYBP204	NSY2SP205	NSYSFD204	-	NSYMP204
2000 (78.74)	400 (15.75)	600 (23.62)	1	NSYSFV20	NSYSFC46	NSYBP204	NSY2SP206	NSYSFD204	-	NSYMP204
2000 (78.74)	400 (15.75)	800 (31.50)	1	NSYSFV20	NSYSFC48	NSYBP204	NSY2SP208	NSYSFD204	-	NSYMP204
2000 (78.74)	600 (23.62)	400 (15.75)	1	NSYSFV20	NSYSFC64	NSYBP206	NSY2SP204	NSYSFD206	NSYSFD206T	NSYMP206
2000 (78.74)	600 (23.62)	500 (19.68)	1	NSYSFV20	NSYSFC65	NSYBP206	NSY2SP205	NSYSFD206	NSYSFD206T	NSYMP206
2000 (78.74)	600 (23.62)	600 (23.62)	1	NSYSFV20	NSYSFC66	NSYBP206	NSY2SP206	NSYSFD206	NSYSFD206T	NSYMP206
2000 (78.74)	600 (23.62)	800 (31.50)	1	NSYSFV20	NSYSFC68	NSYBP206	NSY2SP208	NSYSFD206	NSYSFD206T	NSYMP206
2000 (78.74)	800 (31.50)	400 (15.75)	1	NSYSFV20	NSYSFC84	NSYBP208	NSY2SP204	NSYSFD208	NSYSFD208T	NSYMP208
2000 (78.74)	800 (31.50)	500 (19.68)	1	NSYSFV20	NSYSFC85	NSYBP208	NSY2SP205	NSYSFD208	NSYSFD208T	NSYMP208
2000 (78.74)	800 (31.50)	600 (23.62)	1	NSYSFV20	NSYSFC86	NSYBP208	NSY2SP206	NSYSFD208	NSYSFD208T	NSYMP208
2000 (78.74)	800 (31.50)	600 (23.62)	2	NSYSFV20	NSYSFC86	NSYBP208	NSY2SP206	NSYSFD2082D	-	NSYMP208
2000 (78.74)	800 (31.50)	800 (31.50)	1	NSYSFV20	NSYSFC88	NSYBP208	NSY2SP208	NSYSFD208	NSYSFD208T	NSYMP208
2000 (78.74)	800 (31.50)	800 (31.50)	2	NSYSFV20	NSYSFC88	NSYBP208	NSY2SP208	NSYSFD2082D	-	NSYMP208
2000 (78.74)	1000 (39.37)	400 (15.75)	1	NSYSFV20	NSYSFC104	NSYBP2010	NSY2SP204	NSYSFD2010	NSYSFD2010T	NSYMP2010
2000 (78.74)	1000 (39.37)	400 (15.75)	2	NSYSFV20	NSYSFC104	NSYBP2010	NSY2SP204	NSYSFD20102D	-	NSYMP2010
2000 (78.74)	1000 (39.37)	500 (19.68)	1	NSYSFV20	NSYSFC105	NSYBP2010	NSY2SP205	NSYSFD2010	NSYSFD2010T	NSYMP2010
2000 (78.74)	1000 (39.37)	500 (19.68)	2	NSYSFV20	NSYSFC105	NSYBP2010	NSY2SP205	NSYSFD20102D	-	NSYMP2010
2000 (78.74)	1000 (39.37)	600 (23.62)	1	NSYSFV20	NSYSFC106	NSYBP2010	NSY2SP206	NSYSFD2010	NSYSFD2010T	NSYMP2010
2000 (78.74)	1000 (39.37)	600 (23.62)	2	NSYSFV20	NSYSFC106	NSYBP2010	NSY2SP206	NSYSFD20102D	-	NSYMP2010
2000 (78.74)	1000 (39.37)	800 (31.50)	1	NSYSFV20	NSYSFC108	NSYBP2010	NSY2SP208	NSYSFD2010	NSYSFD2010T	NSYMP2010
2000 (78.74)	1000 (39.37)	800 (31.50)	2	NSYSFV20	NSYSFC108	NSYBP2010	NSY2SP208	NSYSFD20102D	-	NSYMP2010
2000 (78.74)	1200 (47.24)	400 (15.75)	2	NSYSFV20	NSYSFC124	NSYBP2012	NSY2SP204	NSYSFD20122D	NSYSFD20122DT	NSYMP2012
2000 (78.74)	1200 (47.24)	500 (19.68)	2	NSYSFV20	NSYSFC125	NSYBP2012	NSY2SP205	NSYSFD20122D	NSYSFD20122DT	NSYMP2012
2000 (78.74)	1200 (47.24)	600 (23.62)	2	NSYSFV20	NSYSFC126	NSYBP2012	NSY2SP206	NSYSFD20122D	NSYSFD20122DT	NSYMP2012
2000 (78.74)	1200 (47.24)	800 (31.50)	2	NSYSFV20	NSYSFC128	NSYBP2012	NSY2SP208	NSYSFD20122D	NSYSFD20122DT	NSYMP2012
2000 (78.74)	1600 (62.99)	400 (15.75)	2	NSYSFV20	NSYSFC164	NSYBP2016	NSY2SP204	NSYSFD20162D	-	NSYMP2016
2000 (78.74)	1600 (62.99)	500 (19.68)	2	NSYSFV20	NSYSFC165	NSYBP2016	NSY2SP205	NSYSFD20162D	-	NSYMP2016
2000 (78.74)	1600 (62.99)	600 (23.62)	2	NSYSFV20	NSYSFC166	NSYBP2016	NSY2SP206	NSYSFD20162D	-	NSYMP2016
2200 (86.61)	400 (15.75)	400 (15.75)	1	NSYSFV22	NSYSFC44	NSYBP224	NSY2SP224	NSYSFD224	-	NSYMP224
2200 (86.61)	400 (15.75)	500 (19.68)	1	NSYSFV22	NSYSFC45	NSYBP224	NSY2SP225	NSYSFD224	-	NSYMP224
2200 (86.61)	400 (15.75)	600 (23.62)	1	NSYSFV22	NSYSFC46	NSYBP224	NSY2SP226	NSYSFD224	-	NSYMP224
2200 (86.61)	400 (15.75)	800 (31.50)	1	NSYSFV22	NSYSFC48	NSYBP224	NSY2SP228	NSYSFD224	-	NSYMP224
2200 (86.61)	600 (23.62)	400 (15.75)	1	NSYSFV22	NSYSFC64	NSYBP226	NSY2SP224	NSYSFD226	NSYSFD226T	NSYMP226
2200 (86.61)	600 (23.62)	500 (19.68)	1	NSYSFV22	NSYSFC65	NSYBP226	NSY2SP225	NSYSFD226	NSYSFD226T	NSYMP226
2200 (86.61)	600 (23.62)	600 (23.62)	1	NSYSFV22	NSYSFC66	NSYBP226	NSY2SP226	NSYSFD226	NSYSFD226T	NSYMP226
2200 (86.61)	600 (23.62)	800 (31.50)	1	NSYSFV22	NSYSFC68	NSYBP226	NSY2SP228	NSYSFD226	NSYSFD226T	NSYMP226
2200 (86.61)	800 (31.50)	400 (15.75)	1	NSYSFV22	NSYSFC84	NSYBP228	NSY2SP224	NSYSFD228	NSYSFD228T	NSYMP228
2200 (86.61)	800 (31.50)	500 (19.68)	1	NSYSFV22	NSYSFC85	NSYBP228	NSY2SP225	NSYSFD228	NSYSFD228T	NSYMP228
2200 (86.61)	800 (31.50)	600 (23.62)	1	NSYSFV22	NSYSFC86	NSYBP228	NSY2SP226	NSYSFD228	NSYSFD228T	NSYMP228
2200 (86.61)	800 (31.50)	800 (31.50)	1	NSYSFV22	NSYSFC88	NSYBP228	NSY2SP228	NSYSFD228	NSYSFD228T	NSYMP228
2200 (86.61)	1000 (39.37)	400 (15.75)	1	NSYSFV22	NSYSFC104	NSYBP2210	NSY2SP224	NSYSFD2210	NSYSFD2210T	NSYMP2210
2200 (86.61)	1000 (39.37)	500 (19.68)	1	NSYSFV22	NSYSFC105	NSYBP2210	NSY2SP225	NSYSFD2210	NSYSFD2210T	NSYMP2210
2200 (86.61)	1000 (39.37)	600 (23.62)	1	NSYSFV22	NSYSFC106	NSYBP2210	NSY2SP226	NSYSFD2210	NSYSFD2210T	NSYMP2210
2200 (86.61)	1000 (39.37)	800 (31.50)	1	NSYSFV22	NSYSFC108	NSYBP2210	NSY2SP228	NSYSFD2210	NSYSFD2210T	NSYMP2210
2200 (86.61)	1200 (47.24)	400 (15.75)	2	NSYSFV22	NSYSFC124	NSYBP2212	NSY2SP224	NSYSFD22122D	NSYSFD22122DT	NSYMP2212
2200 (86.61)	1200 (47.24)	500 (19.68)	2	NSYSFV22	NSYSFC125	NSYBP2212	NSY2SP225	NSYSFD22122D	NSYSFD22122DT	NSYMP2212
2200 (86.61)	1200 (47.24)	600 (23.62)	2	NSYSFV22	NSYSFC126	NSYBP2212	NSY2SP226	NSYSFD22122D	NSYSFD22122DT	NSYMP2212
2200 (86.61)	1200 (47.24)	800 (31.50)	2	NSYSFV22	NSYSFC128	NSYBP2212	NSY2SP228	NSYSFD22122D	NSYSFD22122DT	NSYMP2212

Technical changes reserved. Information provided without guarantee. Images are for illustrative purposes only.

Side door

3



Supply:
One side door, four hinges,
four catches and handle lock

- Door for the side of the enclosure, replaces the side panel.
- Installation directly on the structure of the enclosure, opening 120°.
- Lock with handle and 5 (0.20) mm (in.) double-bar insert. 4 locking points.
- Reinforcement frame, cut-out with a pitch of 25 (0.98) mm (in.).
- Opening to right or left.
- Material: Steel
- Finish: Structured finish, epoxy polyester powder
- Color: RAL 7035 grey
- Ingress protection rating: IP55 according to IEC 60529



NSYSFD126

Characteristics	Height mm (in.)	Depth mm (in.)	References
Spacial SF Side door	1200 (47.24)	600 (23.62)	NSYSFD126
Spacial SF Side door	1200 (47.24)	800 (31.50)	NSYSFD128
Spacial SF Side door	1400 (55.12)	600 (23.62)	NSYSFD146
Spacial SF Side door	1400 (55.12)	800 (31.50)	NSYSFD148
Spacial SF Side door	1600 (62.99)	600 (23.62)	NSYSFD166
Spacial SF Side door	1600 (62.99)	800 (31.50)	NSYSFD168
Spacial SF Side door	1800 (70.87)	400 (15.75)	NSYSFD184
Spacial SF Side door	1800 (70.87)	500 (19.68)	NSYSFD185
Spacial SF Side door	1800 (70.87)	600 (23.62)	NSYSFD186
Spacial SF Side door	1800 (70.87)	800 (31.50)	NSYSFD188
Spacial SF Side door	2000 (78.74)	400 (15.75)	NSYSFD204
Spacial SF Side door	2000 (78.74)	500 (19.68)	NSYSFD205
Spacial SF Side door	2000 (78.74)	600 (23.62)	NSYSFD206
Spacial SF Side door	2000 (78.74)	800 (31.50)	NSYSFD208
Spacial SF Side door	2200 (86.61)	400 (15.75)	NSYSFD224
Spacial SF Side door	2200 (86.61)	500 (19.68)	NSYSFD225
Spacial SF Side door	2200 (86.61)	600 (23.62)	NSYSFD226
Spacial SF Side door	2200 (86.61)	800 (31.50)	NSYSFD228

External fixing

- Set of 2 side panels fixed from the outside of the enclosure.
- Material: Steel
- Finish: Structured finish, epoxy polyester powder
- Color: RAL 7035 grey
- Ingress protection rating: IP55 according to IEC 60529

Supply:
2 side panels, with sealing gasket and bag of accessories



NSY2SP124

Characteristics	Height mm (in.)	Depth mm (in.)	References
Set of 2 side panels fixed from the outside of the enclosure	1200 (47.24)	400 (15.75)	NSY2SP124
Set of 2 side panels fixed from the outside of the enclosure	1200 (47.24)	500 (19.68)	NSY2SP125
Set of 2 side panels fixed from the outside of the enclosure	1200 (47.24)	600 (23.62)	NSY2SP126
Set of 2 side panels fixed from the outside of the enclosure	1200 (47.24)	800 (31.50)	NSY2SP128
Set of 2 side panels fixed from the outside of the enclosure	1400 (55.12)	400 (15.75)	NSY2SP144
Set of 2 side panels fixed from the outside of the enclosure	1400 (55.12)	500 (19.68)	NSY2SP145
Set of 2 side panels fixed from the outside of the enclosure	1400 (55.12)	600 (23.62)	NSY2SP146
Set of 2 side panels fixed from the outside of the enclosure	1400 (55.12)	800 (31.50)	NSY2SP148
Set of 2 side panels fixed from the outside of the enclosure	1600 (62.99)	400 (15.75)	NSY2SP164
Set of 2 side panels fixed from the outside of the enclosure	1600 (62.99)	500 (19.68)	NSY2SP165
Set of 2 side panels fixed from the outside of the enclosure	1600 (62.99)	600 (23.62)	NSY2SP166
Set of 2 side panels fixed from the outside of the enclosure	1600 (62.99)	800 (31.50)	NSY2SP168
Set of 2 side panels fixed from the outside of the enclosure	1800 (70.87)	400 (15.75)	NSY2SP184
Set of 2 side panels fixed from the outside of the enclosure	1800 (70.87)	500 (19.68)	NSY2SP185
Set of 2 side panels fixed from the outside of the enclosure	1800 (70.87)	600 (23.62)	NSY2SP186
Set of 2 side panels fixed from the outside of the enclosure	1800 (70.87)	800 (31.50)	NSY2SP188
Set of 2 side panels fixed from the outside of the enclosure	2000 (78.74)	400 (15.75)	NSY2SP204
Set of 2 side panels fixed from the outside of the enclosure	2000 (78.74)	500 (19.68)	NSY2SP205
Set of 2 side panels fixed from the outside of the enclosure	2000 (78.74)	600 (23.62)	NSY2SP206
Set of 2 side panels fixed from the outside of the enclosure	2000 (78.74)	800 (31.50)	NSY2SP208
Set of 2 side panels fixed from the outside of the enclosure	2200 (86.61)	400 (15.75)	NSY2SP224
Set of 2 side panels fixed from the outside of the enclosure	2200 (86.61)	500 (19.68)	NSY2SP225
Set of 2 side panels fixed from the outside of the enclosure	2200 (86.61)	600 (23.62)	NSY2SP226
Set of 2 side panels fixed from the outside of the enclosure	2200 (86.61)	800 (31.50)	NSY2SP228

Internal fixing

- Set of 2 side panels fixed from the enclosure, helping prevent access by unauthorized persons.
- Very useful in public spaces.
- Material: Steel
- Finish: Painted with epoxy polyester resin
- Color: RAL 7035 grey
- Ingress protection rating: IP55 according to IEC 60529

Supply:
2 side panels, with sealing gasket and bag of accessories



NSY2SPI26

Characteristics	Height mm (in.)	Depth mm (in.)	References
Set of 2 side panels fixed from the enclosure	1200 (47.24)	600 (23.62)	NSY2SPI26
Set of 2 side panels fixed from the enclosure	1800 (70.87)	500 (19.68)	NSY2SPI185
Set of 2 side panels fixed from the enclosure	1800 (70.87)	600 (23.62)	NSY2SPI186
Set of 2 side panels fixed from the enclosure	1800 (70.87)	800 (31.50)	NSY2SPI188
Set of 2 side panels fixed from the enclosure	2000 (78.74)	400 (15.75)	NSY2SPI204
Set of 2 side panels fixed from the enclosure	2000 (78.74)	500 (19.68)	NSY2SPI205
Set of 2 side panels fixed from the enclosure	2000 (78.74)	600 (23.62)	NSY2SPI206
Set of 2 side panels fixed from the enclosure	2000 (78.74)	800 (31.50)	NSY2SPI208
Set of 2 side panels fixed from the enclosure	2200 (86.61)	600 (23.62)	NSY2SPI226
Set of 2 side panels fixed from the enclosure	2200 (86.61)	800 (31.50)	NSY2SPI228

Technical changes reserved. Information provided without guarantee. Images are for illustrative purposes only.



Internal fixing rear panel

- Rear panel fixed from the inside of the enclosure, helping prevent unauthorized personnel from accessing and removing it. Normally used in public spaces.
- Material: Steel
- Finish: Painted with epoxy polyester resin
- Color: RAL 7035 grey
- Ingress protection rating: IP55 according to IEC 60529

Supply:
1 rear panel and fixing elements

Characteristics	Height mm (in.)	Depth mm (in.)	References
Rear panel fixed from the inside of the enclosure	1800 (70.87)	1000 (39.37)	NSYBPI1810
Rear panel fixed from the inside of the enclosure	2000 (78.74)	600 (23.62)	NSYBPI206
Rear panel fixed from the inside of the enclosure	2000 (78.74)	800 (31.50)	NSYBPI208
Rear panel fixed from the inside of the enclosure	2000 (78.74)	1000 (39.37)	NSYBPI2010
Rear panel fixed from the inside of the enclosure	2200 (86.61)	800 (31.50)	NSYBPI228
Rear panel fixed from the inside of the enclosure	2200 (86.61)	1000 (39.37)	NSYBPI2210



NSYBPI1810

Partition panel

- Partition panel for direct fixing to the structure, helps guarantee a water/dustproof protection of IP10 between enclosure suites.
- Material: Galvanized steel
- Color: RAL 7035 grey
- Ingress protection rating: IP55 according to IEC 60529

Supply:
1 partition panel, sealing gasket and fixing elements

Characteristics	Height mm (in.)	Depth mm (in.)	References
Spacial SF partition panel	1600 (62.99)	600 (23.62)	NSYPPS166
Spacial SF partition panel	1600 (62.99)	800 (31.50)	NSYPPS168
Spacial SF partition panel	1800 (70.87)	400 (15.75)	NSYPPS184
Spacial SF partition panel	1800 (70.87)	500 (19.68)	NSYPPS185
Spacial SF partition panel	1800 (70.87)	600 (23.62)	NSYPPS186
Spacial SF partition panel	2000 (78.74)	400 (15.75)	NSYPPS204
Spacial SF partition panel	2000 (78.74)	500 (19.68)	NSYPPS205
Spacial SF partition panel	2000 (78.74)	600 (23.62)	NSYPPS206
Spacial SF partition panel	2000 (78.74)	800 (31.50)	NSYPPS208
Spacial SF partition panel	2200 (86.61)	600 (23.62)	NSYPPS226
Spacial SF partition panel	2200 (86.61)	800 (31.50)	NSYPPS228



NSYPPS166

Accessories

- Trim cap for external fixing panels, both sides and rear
- Material: Polyamide 6
- Color: RAL 7035 grey

Supply:
50 units

Characteristics	References
Trim cap for external fixing panels	NSYCSP



NSYCSP

Plinth as a kit

The complete plinth consists of two elements, one is the front and rear kit, determined by the length of the enclosure, and the other consists of the side panels which determine the depth of the enclosure. The number of side panels required depends on the plinth combination.

3

- + Robust design.
- + The modular plinth system makes it possible to reduce the number of references in stock.

Characteristics	Front and rear kit	Side panels	Complete plinth
Plinth height 100 (3.94) mm (in.)			
Plinth height 200 (7.87) mm (in.)			

Floor

Examples of solutions

Plinth cross-rail fixed in position B, requires 2 cross-rails fixed in position A.

- They are fixed to the plinth cross-rails, both the universal and the quick-fixing types.
- Their depth is adjustable in increments of 25 (0.98) mm (in.).

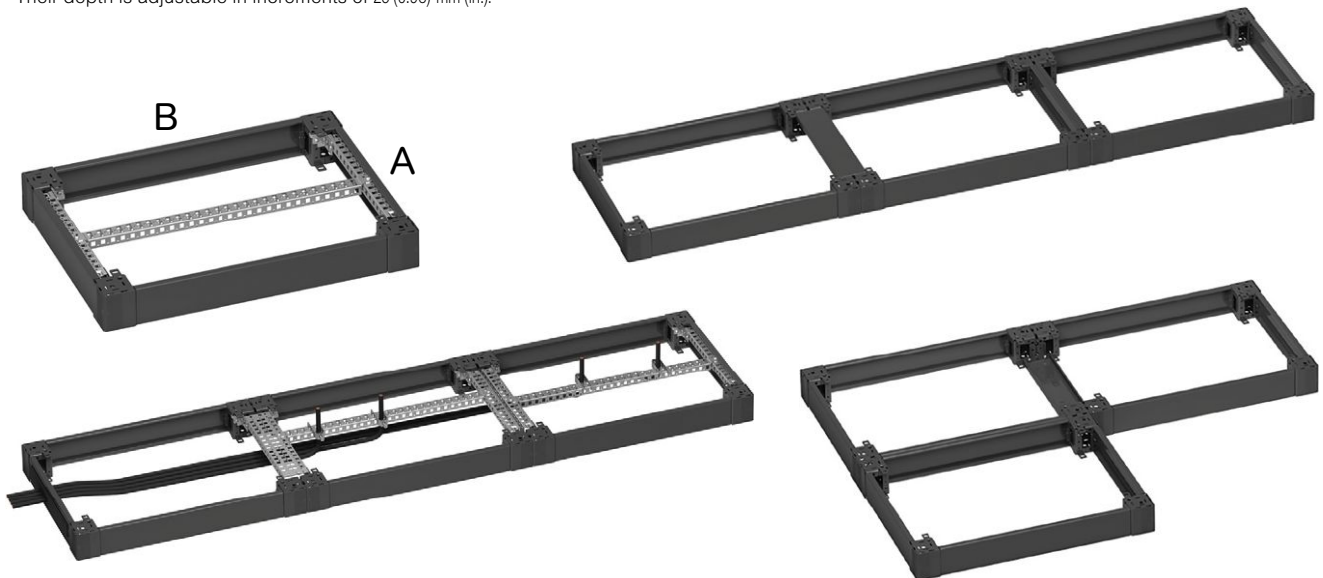

Comment: Universal and quick-fixing cross-rail references, [page 254](#)

Possibility of joining plinths

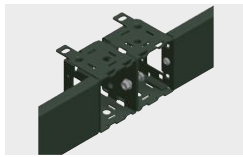

The surfaces between corners are always in contact.

They are joined by a M8 screw and nut, not included in the standard supply.

- + Longitudinally free space for passing cables
- + Greater rigidity of the resulting assembly unit

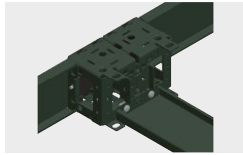
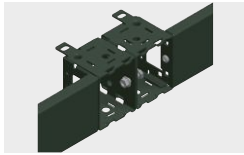

Side panels

are secured by M6 screws and caged nuts, not included in the standard supply, reference **NSYSMP6** and reference **NSYCN9M625**, which can be mounted above and/or below.

- + Improves rigidity in the depthwise direction during transport

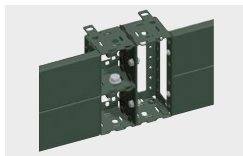

Vertical plinth assembly

are secured by means of M12 screws and nuts, not included in the standard supply.

- + The two heights of corners can be combined

Possibility of fixing the enclosure to the plinth

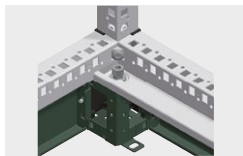

Fixing from the inside of the enclosure

by means of an M12 screw, screwing directly into the corner of the plinth.

- + Fixing convenience and speed



Fixing from the outside of the enclosure

with a M12 screw, screwing directly onto the vertical upright.

- + Maximum rigidity of the enclosure-plinth assembly

Possibility of fixing the plinth to the floor



Fixing from the inside of the enclosure.

The machining angle varies according to the plinth model:

- Plinth height 100 (3.94) mm (in.) $\varphi = 18^\circ$.
- Plinth height 200 (7.87) mm (in.) $\varphi = 9^\circ$.



Fixing from the outside of the enclosure, optimal point for the rigidity of the assembly.

The machining angle varies according to the plinth model:

- Plinth height 100 (3.94) mm (in.) $\varphi = 22^\circ$.
- Plinth height 200 (7.87) mm (in.) $\varphi = 11^\circ$.



Floor-fixing supports can be used as well.

- Reference **NSYSGF**, to fix the corner or the panel and the corner to the floor.

The corners can be rotated if the side panels of the plinth need to be removed and/or to obtain access to the external fixing when the set is set up against the wall.

Fixing the enclosure to the floor



Fixing from the outside of the enclosure

Optimal point for the rigidity of the assembly.

The machining angle varies according to the plinth model:

- Plinth height 100 (3.94) mm (in.) $\varphi = 22^\circ$.
- Plinth height 200 (7.87) mm (in.) $\varphi = 11^\circ$.

Fixing the enclosure to the floor



Enclosure against a wall

Thanks to the design of the corners, when the enclosure is installed against the wall, the following is possible:

- To remove the side panels (turning back corners),
 - To access the external fixing to the floor.
- It is also possible to use floor-fixing supports, reference **NSYSGF**, to fix the corner or the panel and the corner to the floor.

Fixing the enclosure to the plinth

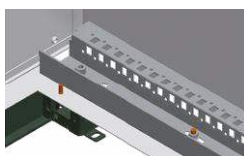

Fixing from the inside of the enclosure

by means of a M12 screw, screwing directly into the corner of the plinth

- + Fixing convenience and speed.

Assembly of the plinth panels

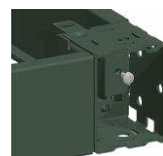

The panels are fixed with an M6 screw to the corner

included in the standard supply of the side panels.

- The front and rear panels are delivered with the corners mounted

Front and rear plinths

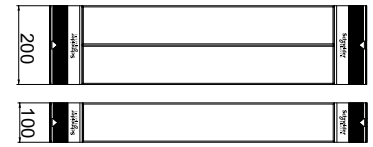
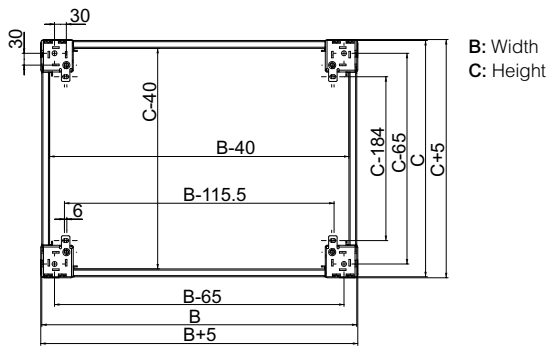

- The front and rear of the plinth consists of 4 corners with 2 or 4 panels.
- Material: Folded sheet steel, corner with a thickness of 25 (0.98) mm (in.)
- Finish: Structured finish, epoxy polyester powder
- Color: RAL 7022 grey
- Ingress protection rating: IP30 according to IEC 60529
- Mechanical protection rating: IK10 according to IEC 62262

Supply:

Height 100 (3.94) mm (in.): 4 corners, 2 panels (front and rear), 4 corner covers and fixing elements
 Height 200 (7.87) mm (in.): 4 corners, 4 panels (2 front and 2 rear), 4 corner covers and fixing elements



Characteristics	Height mm (in.)	Width mm (in.)	References
Front plinths for Spacial	100 (3.94)	300 (11.81)	NSYSPPF3100
Front plinths for Spacial	100 (3.94)	400 (15.75)	NSYSPPF4100
Front plinths for Spacial	100 (3.94)	600 (23.62)	NSYSPPF6100
Front plinths for Spacial	100 (3.94)	800 (31.50)	NSYSPPF8100
Front plinths for Spacial	100 (3.94)	1000 (39.37)	NSYSPPF10100
Front plinths for Spacial	100 (3.94)	1200 (47.24)	NSYSPPF12100
Front plinths for Spacial	100 (3.94)	1600 (62.99)	NSYSPPF16100
Front plinths for Spacial	200 (7.87)	300 (11.81)	NSYSPPF3200
Front plinths for Spacial	200 (7.87)	400 (15.75)	NSYSPPF4200
Front plinths for Spacial	200 (7.87)	600 (23.62)	NSYSPPF6200
Front plinths for Spacial	200 (7.87)	800 (31.50)	NSYSPPF8200
Front plinths for Spacial	200 (7.87)	1000 (39.37)	NSYSPPF10200
Front plinths for Spacial	200 (7.87)	1200 (47.24)	NSYSPPF12200
Front plinths for Spacial	200 (7.87)	1600 (62.99)	NSYSPPF16200

Plinth side panels



- They are fixed to the corner of the plinth by 2 fixing screws.
- Material: Folded sheet steel
- Finish: Structured finish, epoxy polyester powder
- Color: RAL 7022 grey
- Ingress protection rating: IP30 according to IEC 60529
- Mechanical protection rating: IK10 according to IEC 62262

Supply:

Height 100 (3.94) mm (in.): 2 side panels, 4 corner covers and fixing elements
 Height 200 (7.87) mm (in.): 4 side panels (height of 100 (3.94) mm (in.), 2 for each side), 4 corner covers and fixing elements

Characteristics	Height mm (in.)	Depth mm (in.)	References
Side plinths for Spacial	100 (3.94)	300 (11.81)	NSYSPPS3100
Side plinths for Spacial	100 (3.94)	400 (15.75)	NSYSPPS4100
Side plinths for Spacial	100 (3.94)	500 (19.68)	NSYSPPS5100
Side plinths for Spacial	100 (3.94)	600 (23.62)	NSYSPPS6100
Side plinths for Spacial	100 (3.94)	800 (31.50)	NSYSPPS8100
Side plinths for Spacial	200 (7.87)	300 (11.81)	NSYSPPS3200
Side plinths for Spacial	200 (7.87)	400 (15.75)	NSYSPPS4200
Side plinths for Spacial	200 (7.87)	500 (19.68)	NSYSPPS5200
Side plinths for Spacial	200 (7.87)	600 (23.62)	NSYSPPS6200
Side plinths for Spacial	200 (7.87)	800 (31.50)	NSYSPPS8200

Ventilated front plinth



NSYSPFV6100

- The front and rear of the ventilated plinth is made up of 4 corners with 2 front panels.
- Material: Folded sheet steel, corner with a thickness of 25 (0.98) mm (in.)
- Finish: Structured finish, epoxy polyester powder
- Color: RAL 7022 grey
- Ingress protection rating: IP20 according to IEC 60529
- Mechanical protection rating: IK10 according to IEC 62262

Supply:
Height 100 (39.37) mm (in.): 4 corners, 2 ventilated panels (front and rear), 4 corner covers and fixing elements

Characteristics	Height mm (in.)	Width mm (in.)	References
Ventilated front plinth for Spacial SF-SM	100 (3.94)	600 (23.62)	NSYSPFV6100
Ventilated front plinth for Spacial SF-SM	100 (3.94)	800 (31.50)	NSYSPFV8100

Ventilated side panels



NSYSPV6100

- They are fixed to the corner of the plinth by fixing screws.
- Material: Folded sheet steel
- Finish: Structured finish, epoxy polyester powder
- Color: RAL 7022 grey
- Ingress protection rating: IP20 according to IEC 60529
- Mechanical protection rating: IK10 according to IEC 62262

Supply:
Height 100 (39.37) mm (in.): 2 ventilated side panels, 4 corner covers and fixing elements

Characteristics	Height mm (in.)	Depth mm (in.)	References
Ventilated side panels for Spacial SF-SM	100 (3.94)	600 (23.62)	NSYSPV6100
Ventilated side panels for Spacial SF-SM	100 (3.94)	800 (31.50)	NSYSPV8100

Panels with brush



NSYSPB6100

- They allow the entry and fixing of cables inside the enclosure, through the plinth.
- Material: Folded sheet steel
- Finish: Structured finish, epoxy polyester powder
- Color: RAL 7022 grey
- Ingress protection rating: IP20 according to IEC 60529
- Mechanical protection rating: IK10 according to IEC 62262

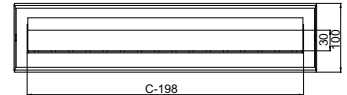

Supply:
Height 100 (39.37) mm (in.): 2 panels with brushes, 4 corner covers and fixing elements

Characteristics	Height mm (in.)	Depth mm (in.)	References
Panels with brush for Spacial SF-SM	100 (3.94)	600 (23.62)	NSYSPB6100
Panels with brush for Spacial SF-SM	100 (3.94)	800 (31.50)	NSYSPB8100



Stainless-steel plinths (standard plinths [page 162](#), ventilated plinths [page 331](#)) are compatible with steel floor-standing enclosure SM and SF using an earthing cable reference **NSYEL226D13** (description [page 303](#)) to be ordered separately.

Fixing to the floor

3



NSYSGF

- Part for fixing the plinth to the floor if the drillholes made in the plinth cannot be used.
- Material: Steel
- Finish: Zinc-coated

Characteristics

Spacial SF-Fixing to the floor

References

NSYSGF



Supply:

4 pieces, fixing element not supplied

Fixing to the floor by fixing points of previous version (OLN/CMO or Spacial 6000 and 18500)



NSYOL6GF

- Parts that reproduce the floor-fixing points of the previous plinth.
- Material: Steel
- Finish: Zinc-coated

Characteristics

Fixing to the floor by fixing points of previous version

References

NSYOL6GF

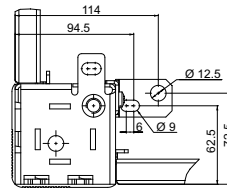

Supply:

4 pieces, fixing elements not supplied

Plinth cross-rail support



NSYSPCR

- Support for fixing a cross-rail inside the plinth.
- Material: Steel
- Finish: Zinc-coated

Characteristics

Spacial SF-Plinth cross-rail support, 100 (3.94) mm (in.)

References

NSYSPCR

Comment:

Reference by unit Order by multiples of 12 (12, 24, 36...)

Supply:

12 pieces and fixing elements



Plinth cross-rails

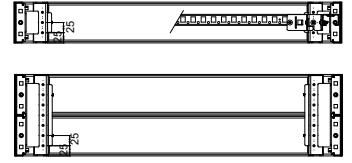

- They are fixed across the width and/or depth between the corners of the plinth.
- The plinth cross-rail supports are required for its assembly.
- Material: Steel
- Finish: Zinc-coated

Supply:
2 cross-rails and fixing elements



NSYSUCR4030

Characteristics	Cross-rails	Width mm (in.)	Depth mm (in.)	References
Plinth cross-rails for Spacial SF-SM	1 row (40)	400 (15.75)	-	NSYSUCR4030
Plinth cross-rails for Spacial SF-SM	1 row (40)	600 (23.62)	-	NSYSUCR4050
Plinth cross-rails for Spacial SF-SM	1 row (40)	800 (31.50)	-	NSYSUCR4070
Plinth cross-rails for Spacial SF-SM	1 row (40)	1000 (39.37)	-	NSYSUCR4090
Plinth cross-rails for Spacial SF-SM	1 row (40)	1200 (47.24)	-	NSYSUCR40110
Plinth cross-rails for Spacial SF-SM	3 row (90)	400 (15.75)	-	NSYSUCR9030
Plinth cross-rails for Spacial SF-SM	3 row (90)	600 (23.62)	-	NSYSUCR9050
Plinth cross-rails for Spacial SF-SM	3 row (90)	800 (31.50)	-	NSYSUCR9070
Plinth cross-rails for Spacial SF-SM	3 row (90)	1000 (39.37)	-	NSYSUCR9090
Plinth cross-rails for Spacial SF-SM	3 row (90)	1200 (47.24)	-	NSYSUCR90110
Plinth cross-rails for Spacial SF-SM	1 row (40)	-	500 (19.68)	NSYSUCR4040
Plinth cross-rails for Spacial SF-SM	3 row (90)	-	500 (19.68)	NSYSUCR9040

Fixing options, Screw M6



NSYSPM6

- M6 x 10 (0,39) mm (in.)

Supply:
50 screws

Characteristics	References
Screw M6	NSYSPM6

Fixing options, Caged nuts



NSYCN9M625

- M6 caged nuts.

Supply:
100 caged nuts.

Characteristics	References
Caged nuts	NSYCN9M625

Fixing options, Levelling the plinth

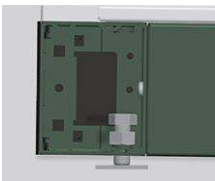

NSYSPLK

- The plinth allows levelling by means of a M12 screw.

Characteristics	References
Levelling the plinth	NSYSPLK

Cable entries

Possibilities of cable gland plate adjustment

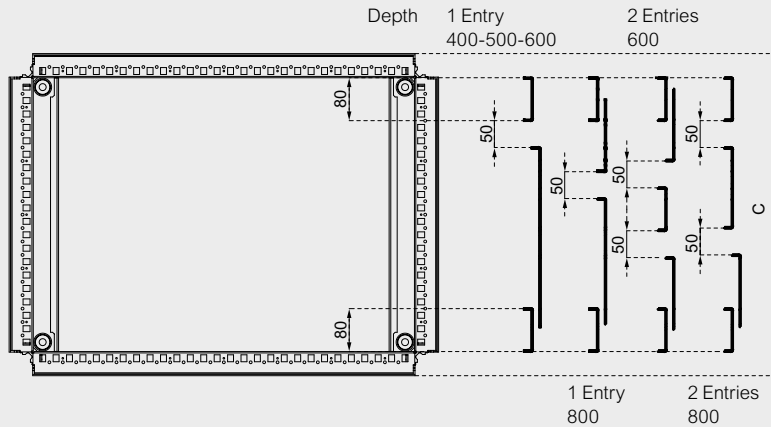

Plain cable gland plate

- The design of the compact cable gland plate, coupled with the use of the sealing gasket **NSYCEK** enable maximum dust/water tightness.
- Material: Steel painted with epoxy polyester resin
- Color: RAL 7035 grey
- Thicknesses: 10 (0.39) mm (in.)

Supply:
Plain plate and fixing elements

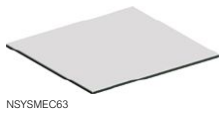

NSYSMEC63

Characteristics	Width mm (in.)	Depth mm (in.)	References
Spacial SM Plain cable gland plate	600 (23.62)	300 (11.81)	NSYSMEC63
Spacial SM Plain cable gland plate	600 (23.62)	400 (15.75)	NSYSMEC64
Spacial SM Plain cable gland plate	600 (23.62)	500 (19.68)	NSYSMEC65
Spacial SM Plain cable gland plate	600 (23.62)	600 (23.62)	NSYSMEC66
Spacial SM Plain cable gland plate	800 (31.50)	300 (11.81)	NSYSMEC83
Spacial SM Plain cable gland plate	800 (31.50)	400 (15.75)	NSYSMEC84
Spacial SM Plain cable gland plate	800 (31.50)	500 (19.68)	NSYSMEC85
Spacial SM Plain cable gland plate	800 (31.50)	600 (23.62)	NSYSMEC86
Spacial SM Plain cable gland plate	1000 (39.37)	300 (11.81)	NSYSMEC103
Spacial SM Plain cable gland plate	1000 (39.37)	400 (15.75)	NSYSMEC104
Spacial SM Plain cable gland plate	1000 (39.37)	500 (19.68)	NSYSMEC105
Spacial SM Plain cable gland plate	1200 (47.24)	300 (11.81)	2x NSYSMEC63
Spacial SM Plain cable gland plate	1200 (47.24)	400 (15.75)	2x NSYSMEC64
Spacial SM Plain cable gland plate	1200 (47.24)	500 (19.68)	2x NSYSMEC65
Spacial SM Plain cable gland plate	1200 (47.24)	600 (23.62)	2x NSYSMEC66
Spacial SM Plain cable gland plate	1600 (62.99)	400 (15.75)	2x NSYSMEC84
Spacial SM Plain cable gland plate	1600 (62.99)	500 (19.68)	2x NSYSMEC85
Spacial SM Plain cable gland plate	1600 (62.99)	600 (23.62)	2x NSYSMEC86

Plain cable gland plate

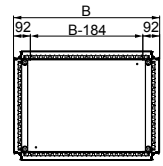

- The design of the compact cable gland plate, coupled with the use of the sealing gasket **NSYCEK** enable maximum dust/water tightness.
- Material: Galvanized steel
- Thicknesses: 15 (0.59) mm (in.)

Supply:
Plain plate and fixing elements

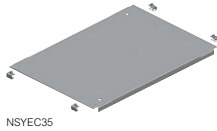

Characteristics	(B) Width mm (in.)	(C) Depth mm (in.)	References
Spacial SF Plain cable gland plate	300 (11.81)	500 (19.68)	NSYEC35
Spacial SF Plain cable gland plate	300 (11.81)	600 (23.62)	NSYEC36
Spacial SF Plain cable gland plate	400 (15.75)	400 (15.75)	NSYEC44
Spacial SF Plain cable gland plate	400 (15.75)	500 (19.68)	NSYEC45
Spacial SF Plain cable gland plate	400 (15.75)	600 (23.62)	NSYEC64
Spacial SF Plain cable gland plate	400 (15.75)	800 (31.50)	NSYEC84
Spacial SF Plain cable gland plate	600 (23.62)	400 (15.75)	NSYEC64
Spacial SF Plain cable gland plate	600 (23.62)	500 (19.68)	NSYEC65
Spacial SF Plain cable gland plate	600 (23.62)	600 (23.62)	NSYEC66
Spacial SF Plain cable gland plate	600 (23.62)	800 (31.50)	NSYEC68
Spacial SF Plain cable gland plate	800 (31.50)	400 (15.75)	NSYEC84
Spacial SF Plain cable gland plate	800 (31.50)	500 (19.68)	NSYEC85
Spacial SF Plain cable gland plate	800 (31.50)	600 (23.62)	NSYEC86
Spacial SF Plain cable gland plate	800 (31.50)	800 (31.50)	NSYEC88
Spacial SF Plain cable gland plate	1000 (39.37)	400 (15.75)	NSYEC104
Spacial SF Plain cable gland plate	1000 (39.37)	500 (19.68)	NSYEC105
Spacial SF Plain cable gland plate	1000 (39.37)	600 (23.62)	NSYEC106
Spacial SF Plain cable gland plate	1000 (39.37)	800 (31.50)	NSYEC108
Spacial SF Plain cable gland plate	1200 (47.24)	400 (15.75)	NSYEC124
Spacial SF Plain cable gland plate	1200 (47.24)	500 (19.68)	NSYEC125
Spacial SF Plain cable gland plate	1200 (47.24)	600 (23.62)	NSYEC126
Spacial SF Plain cable gland plate	1200 (47.24)	800 (31.50)	NSYEC128
Spacial SF Plain cable gland plate	1600 (62.99)	400 (15.75)	NSYEC164
Spacial SF Plain cable gland plate	1600 (62.99)	500 (19.68)	NSYEC165
Spacial SF Plain cable gland plate	1600 (62.99)	600 (23.62)	NSYEC166



Plate with 1 entry

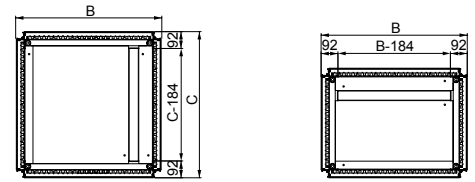

Enclosures of 300 and 400 mm width. Enclosures of 600, 800, 1000 and 1200 mm width.

Supply:
Plate with 1 entry; Self-extinguishing polyurethane adhesive gasket with cross-section of 15 (0.59) x 25 (0.98) mm (in.) (helps guarantee good sealing) and fixing elements

- Facilitates the entry of cables thanks to a longitudinal opening.
- Material: Galvanized steel
- Thicknesses: 15 (0.59) mm (in.)

Characteristics	(B) Width mm (in.)	(C) Depth mm (in.)	References
Spacial SF Plate with 1 entry	300 (11.81)	500 (19.68)	NSYEC351
Spacial SF Plate with 1 entry	300 (11.81)	600 (23.62)	NSYEC361
Spacial SF Plate with 1 entry	400 (15.75)	400 (15.75)	NSYEC441
Spacial SF Plate with 1 entry	400 (15.75)	500 (19.68)	NSYEC451
Spacial SF Plate with 1 entry	400 (15.75)	600 (23.62)	NSYEC461
Spacial SF Plate with 1 entry	400 (15.75)	800 (31.50)	NSYEC481
Spacial SF Plate with 1 entry	600 (23.62)	400 (15.75)	NSYEC641
Spacial SF Plate with 1 entry	600 (23.62)	500 (19.68)	NSYEC651
Spacial SF Plate with 1 entry	600 (23.62)	600 (23.62)	NSYEC661
Spacial SF Plate with 1 entry	600 (23.62)	800 (31.50)	NSYEC681
Spacial SF Plate with 1 entry	800 (31.50)	400 (15.75)	NSYEC841
Spacial SF Plate with 1 entry	800 (31.50)	500 (19.68)	NSYEC851
Spacial SF Plate with 1 entry	800 (31.50)	600 (23.62)	NSYEC861
Spacial SF Plate with 1 entry	800 (31.50)	800 (31.50)	NSYEC881
Spacial SF Plate with 1 entry	1000 (39.37)	400 (15.75)	NSYEC1041
Spacial SF Plate with 1 entry	1000 (39.37)	500 (19.68)	NSYEC1051
Spacial SF Plate with 1 entry	1000 (39.37)	600 (23.62)	NSYEC1061
Spacial SF Plate with 1 entry	1000 (39.37)	800 (31.50)	NSYEC1081
Spacial SF Plate with 1 entry	1200 (47.24)	400 (15.75)	NSYEC1241
Spacial SF Plate with 1 entry	1200 (47.24)	500 (19.68)	NSYEC1251
Spacial SF Plate with 1 entry	1200 (47.24)	600 (23.62)	NSYEC1261
Spacial SF Plate with 1 entry	1200 (47.24)	800 (31.50)	NSYEC1281
Spacial SF Plate with 1 entry	1600 (62.99)	400 (15.75)	NSYEC1641
Spacial SF Plate with 1 entry	1600 (62.99)	500 (19.68)	NSYEC1651
Spacial SF Plate with 1 entry	1600 (62.99)	600 (23.62)	NSYEC1661



NSYEC351

Plate with 2 entries

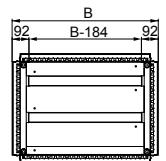

- Cable entry for very deep enclosures (600 (23.62) mm (in.) and 800 (31.50) mm (in.)).
- Two longitudinal openings allowing a large number of cables through.
- Material: Galvanized steel
- Thicknesses: 15 (0.59) mm (in.)

Supply:
1 plate with 2 entries; Polyurethane adhesive gasket with cross-section of 15 (0.59) x 25 (9.84) mm (in.) (helps guarantee good sealing) and fixing elements

Characteristics	(B) Width mm (in.)	(C) Depth mm (in.)	References
Spacial SF Plate with 2 entries	400 (15.75)	600 (23.62)	NSYEC462
Spacial SF Plate with 2 entries	400 (15.75)	800 (31.50)	NSYEC482
Spacial SF Plate with 2 entries	600 (23.62)	600 (23.62)	NSYEC662
Spacial SF Plate with 2 entries	600 (23.62)	800 (31.50)	NSYEC682
Spacial SF Plate with 2 entries	800 (31.50)	600 (23.62)	NSYEC862
Spacial SF Plate with 2 entries	800 (31.50)	800 (31.50)	NSYEC882
Spacial SF Plate with 2 entries	1000 (39.37)	600 (23.62)	NSYEC1062
Spacial SF Plate with 2 entries	1000 (39.37)	800 (31.50)	NSYEC1082
Spacial SF Plate with 2 entries	1200 (47.24)	600 (23.62)	NSYEC1262
Spacial SF Plate with 2 entries	1200 (47.24)	800 (31.50)	NSYEC1282
Spacial SF Plate with 2 entries	1600 (62.99)	600 (23.62)	NSYEC1662



NSYEC662

SF Cable gland plate for connectors

- Adapter plate to install cable entry plates for connectors, see [page 285](#).
- To be used together with cable gland plates, 1 or 2 entries, adding or replacing one of the parts.
- Material: Galvanized steel
- Thicknesses: 15 (0.59) mm (in.)

Supply:
Plate and fixing elements



Characteristics	No. of cuts	Width mm (in.)	References
Spacial SF Cable gland plate for connectors	2	600 (23.62)	NSYDCE6
Spacial SF Cable gland plate for connectors	3	800 (31.50)	NSYDCE8
Spacial SF Cable gland plate for connectors	4	1000 (39.37)	NSYDCE10
Spacial SF Cable gland plate for connectors	4	1200 (47.24)	NSYDCE12

SF Brush-type cable entry gasket

- For plates with 1 or 2 cable entries.
- The cables can have different diameters.
- No IP degree of protection



Characteristics	Width mm (in.)	References
Spacial SF Brush-type cable entry gasket	400 (15.75)	NSYBCE4
Spacial SF Brush-type cable entry gasket	600 (23.62)	NSYBCE6
Spacial SF Brush-type cable entry gasket	800 (31.50)	NSYBCE8
Spacial SF Brush-type cable entry gasket	1000 (39.37)	NSYBCE10
Spacial SF Brush-type cable entry gasket	1200 (47.24)	NSYBCE12
Spacial SF Brush-type cable entry gasket	1600 (62.99)	NSYBCE16

SM Brush-type cable entry gasket

- Brush-type gasket for installation on the cable gland plates.
- The cables can have different diameters.
- No IP degree of protection



Characteristics	Width mm (in.)	References
Spacial SM-Brush-type cable entry gasket	600 (23.62)	NSYSMBCE6
Spacial SM-Brush-type cable entry gasket	800 (31.50)	NSYSMBCE8
Spacial SM-Brush-type cable entry gasket	1000 (39.37)	NSYSMBCE10
Spacial SM-Brush-type cable entry gasket	1200 (47.24)	2x NSYSMBCE6
Spacial SM-Brush-type cable entry gasket	1600 (62.99)	2x NSYSMBCE8

SF Foam cable entry gasket

- Spare gasket, made from self-extinguishing expanded polyurethane with a cross-section of 15 x 25 (0.98) mm (in.), for fixing on cable gland plates.



Characteristics	References
Spacial SF Foam cable entry gasket	NSYCEJ

SF Sealing gasket

- Sealing gasket, made from ethylene-propylene with a cross-section of 3 x 10 (0.39) mm (in.), for mounting on the perimeter of the cable gland plates. Adhesive to help guarantee good sealing.



Characteristics	References
Spacial SF Sealing gasket	NSYCEK

Lifting systems

SF Eyebolts

3



- Set of M12 lifting eyebolts, which screw directly into the structure of the enclosure, in the axis of the uprights.
- Material: Galvanized cast steel
- Maximum load: 340 (749.57) kg (lbs.)
- Maximum amount of assembled enclosures to be lifted: 1

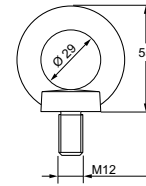

Supply:
4 eyebolts

Characteristics	Enclosures to be lifted	Max. load kg (lbs.)	References
Spacial SF Eyebolts	1	340 (749.57)	NSYSFEB

SM Eyebolts



- Set of M12 lifting eyebolts, fixed to the enclosure by fixing nuts.
- Material: Galvanized cast steel
- Maximum load: 340 (749.57) kg (lbs.)
- Maximum amount of assembled enclosures to be lifted: 1

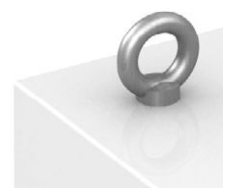
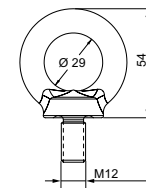

Supply:
4 eyebolts and
4 fixing nuts

Characteristics	Enclosures to be lifted	Max. load kg (lbs.)	References
Spacial SM Eyebolts	1	340 (749.57)	NSYSMEB

SF Lifting brackets



- Set of lifting and transport brackets, fixed to the structure between two coupled enclosures, in the axis of the uprights.
- Material: Zinc-coated steel
- Maximum load: 500 (1102.31) kg (lbs.)
- Maximum amount of assembled enclosures to be lifted: 2

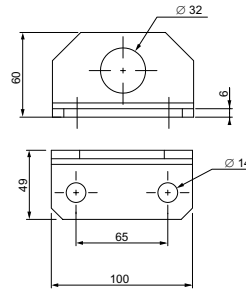

Supply:
4 brackets and fixing
elements (M12 screws)

Characteristics	Enclosures to be lifted	Max. load kg (lbs.)	References
Spacial SF Lifting brackets	2	500 (1102.31)	NSYSFELB

SF Lifting bar



- Set of bars for lifting and transporting enclosures suites.
- They are fixed to the structure of the enclosure, in the axis of the uprights.
- Material: Steel

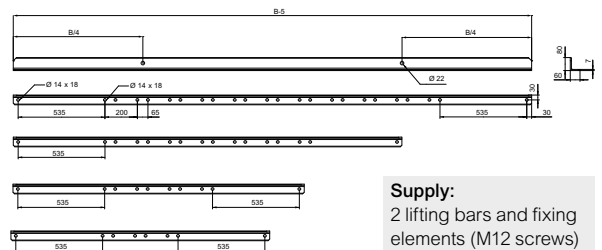

Supply:
2 lifting bars and fixing
elements (M12 screws)

Characteristics	Length mm (in.)	Enclosures to be lifted	Max. load kg (lbs.)	References
Spacial SF Lifting bar	1600 (62.99)	2	2000 (4409.24)	NSYSFTB16
Spacial SF Lifting bar	1800 (70.87)	3	3000 (6613.86)	NSYSFTB18
Spacial SF Lifting bar	2400 (94.49)	4	3000 (6613.86)	NSYSFTB24
Spacial SF Lifting bar	3200 (125.98)	5	4000 (8818.48)	NSYSFTB32

Roof Canopy

- Provides excellent protection against splashes from rainwater.
- Canopy cannot be used together with lifting fixtures.
- Spacial SF: It is possible to use a single canopy with combinations of modular enclosures (example of a 1600 (62.99) mm (in.) canopy with two coupled 800 (31.50) mm (in.) enclosures).
- Material: Galvanized steel
- Finish: Structured finish, epoxy polyester powder
- Color: RAL 7035 grey

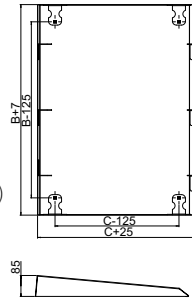

Fixing:
 Spacial SF: Fixing by drill holes to be made in the roof of the enclosure
 Spacial SM: Fixing by drill holes already made in the roof

Supply:
 One canopy, drilling template and fixing elements



NSYSC630

Characteristics	(B) Width mm (in.)	(C) Depth mm (in.)	References
Spacial SF/SM Canopy	600 (23.62)	300 (11.81)	NSYSC630
Spacial SF/SM Canopy	600 (23.62)	400 (15.75)	NSYSC640
Spacial SF/SM Canopy	600 (23.62)	500 (19.68)	NSYSC650
Spacial SF/SM Canopy	600 (23.62)	600 (23.62)	NSYSC660
Spacial SF/SM Canopy	800 (31.50)	300 (11.81)	NSYSC830
Spacial SF/SM Canopy	800 (31.50)	400 (15.75)	NSYSC840
Spacial SF/SM Canopy	800 (31.50)	500 (19.68)	NSYSC850
Spacial SF/SM Canopy	800 (31.50)	600 (23.62)	NSYSC860
Spacial SF/SM Canopy	1000 (39.37)	300 (11.81)	NSYSC1030
Spacial SF/SM Canopy	1000 (39.37)	400 (15.75)	NSYSC1040
Spacial SF/SM Canopy	1000 (39.37)	500 (19.68)	NSYSC1050
Spacial SF/SM Canopy	1000 (39.37)	600 (23.62)	NSYSC1060
Spacial SF/SM Canopy	1200 (47.24)	300 (11.81)	NSYSC1230
Spacial SF/SM Canopy	1200 (47.24)	400 (15.75)	NSYSC1240
Spacial SF/SM Canopy	1200 (47.24)	500 (19.68)	NSYSC1250
Spacial SF/SM Canopy	1200 (47.24)	600 (23.62)	NSYSC1260
Spacial SF/SM Canopy	1600 (62.99)	400 (15.75)	NSYSC1640
Spacial SF/SM Canopy	1600 (62.99)	500 (19.68)	NSYSC1650
Spacial SF/SM Canopy	1600 (62.99)	600 (23.62)	NSYSC1660
Spacial SF/SM Canopy	1800 (70.87)	500 (19.68)	NSYSC1850
Spacial SF/SM Canopy	1800 (70.87)	600 (23.62)	NSYSC1860
Spacial SF/SM Canopy	2000 (78.74)	500 (19.68)	NSYSC2050
Spacial SF/SM Canopy	2000 (78.74)	600 (23.62)	NSYSC2060
Spacial SF/SM Canopy	2400 (94.49)	500 (19.68)	NSYSC2450
Spacial SF/SM Canopy	2400 (94.49)	600 (23.62)	NSYSC2460



Ventilated roof

3

- Roof providing natural airing for the enclosure, with IP30 protection.
- Height: An extra 63 (2.48) mm (in.) in relation to the structure.
- Material: Steel
- Finish: Structured finish, epoxy polyester powder
- Color: RAL 7035 grey
- Fixing: They are screwed onto the structure at the roof fixing point

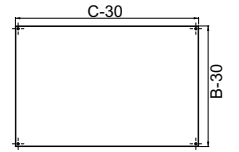
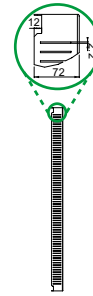

Supply:
One ventilated roof and four elevators



NSYSVR606

Characteristics	(B) Width mm (in.)	(C) Depth mm (in.)	References
Spacial SF Ventilated roof	600 (23.62)	600 (23.62)	NSYSVR606
Spacial SF Ventilated roof	600 (23.62)	800 (31.50)	NSYSVR608
Spacial SF Ventilated roof	800 (31.50)	600 (23.62)	NSYSVR806
Spacial SF Ventilated roof	800 (31.50)	800 (31.50)	NSYSVR808

Airing elevators for roof

- Allows the roof to be raised, providing natural airing.
- They are screwed onto the structure at the roof fixing point.
- Material: Zinc-coated steel



NSYRE26

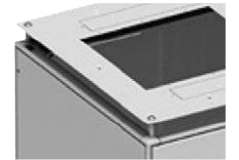
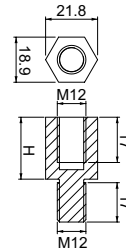

Supply:
4 elevators

Characteristics	(H) Height mm (in.)	IP	References
Spacial SF Airing elevators for roof	23 (0.91)	10	NSYRE26
Spacial SF Airing elevators for roof	60 (2.36)	00	NSYRE60

FL21 cable entry membranes

- Membrane plate for watertight cable entries made from insulated material (fireresistance level UL 94 V-0).
- Direct installation in the FL21 cable entry plate adapter.
- 4 models: Plain plate and membrane plates from 7 to 37 cable entries.
- Material: Grey plastic
- Ingress protection rating: IP66 according to IEC 60529

Comment:
For more information see [page 285](#)

Supply:
Membrane plate and fixing elements.

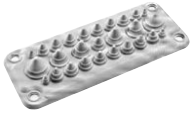

NSYAECPFLT25

Characteristics	No. of entries	References
FL21 plain metal plate	0	NSYAECPFLBP
FL21 cable entry membranes	7	NSYAECPFLT7
FL21 cable entry membranes	27	NSYAECPFLT25
FL21 cable entry membranes	37	NSYAECPFLT35

Standard cable entry plate

- Thickness: 15 (0.59) mm (in.)

Comment:
For more information see [page 285](#)



NSYTLC

Characteristics	References
Standard cable entry plate	NSYTLC

Aluminum cable entry plate

- Thickness: 30 (1.18) mm (in.)

Characteristics	References
Aluminum cable entry plate	NSYTLCU



NSYTLCU

Adapter for FL21 cable entry plate

- Thickness: 15 (0.59) mm (in.)

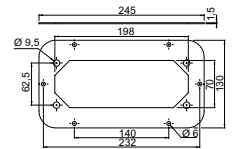

Characteristics	References
Adapter for FL21 cable entry plate	NSYTL CFL

Wall fixing

SF Wall fixing support

3

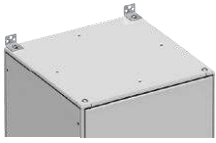

NSYSFWFIX

- Supports for fixing the enclosure on the wall and helping prevent it from turning over.
- They cannot be used for hanging the enclosure.
- They are installed using the roof mounting screws.
- Material: Zinc-coated steel sheet

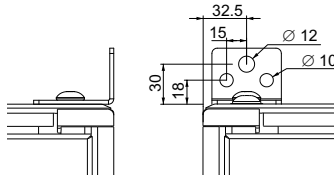

Supply:
2 supports

Characteristics

Spacial SF Wall fixing support

References

NSYSFWFIX

SM Wall fixing support



NSYSMWFIX

- Supports for fixing the enclosure on the wall and helping prevent it from turning over.
- They are installed using the drill holes in the back of the enclosure.
- Enclosure fixed from the outside.
- Material: Zinc-coated steel sheet

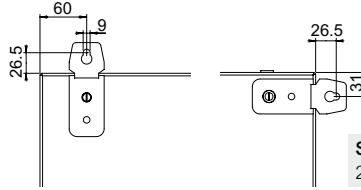

Supply:
2 supports

Characteristics

Spacial SM Wall fixing support

References

NSYSMWFIX

Doors **SF** **SM**

Inner door



NSYID166

- Door for additional protection. Helps prevent the switchgear from being manipulated by unauthorised personnel.
- Allows the installation of switchgear mounted directly on the door.
- Mounting on the top and bottom frame of the enclosure.
- Depth adjustable with a pitch of 25 (0.98) mm (in.), from the first fixing point.
- Opening to right or left, with two locks, 3 (0.12) mm (in.) double-bar, with central handle.
- Reinforcement frames on the rear, cut-outs with a 25 (0.98) mm (in.) pitch, for equipping the door.
- Maximum acceptable load: 15 (33.07) kg (lbs.).
- Inner doors can be mounted in our stainless steel floor-standing enclosures (SFX and SMX).
- Material: Steel
- Finish: Structured finish, epoxy polyester powder
- Color: RAL 7035 grey

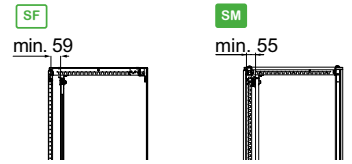

Comment:
For dimensions see [page 132](#)

Supply:
One inner door and fixing elements



NSYID166

Characteristics	Height mm (in.)	Width mm (in.)	References
Spacial SF/SM Inner door	1600 (62.99)	600 (23.62)	NSYID166
Spacial SF/SM Inner door	1600 (62.99)	800 (31.50)	NSYID168
Spacial SF/SM Inner door	1800 (70.87)	600 (23.62)	NSYID186
Spacial SF/SM Inner door	1800 (70.87)	800 (31.50)	NSYID188
Spacial SF/SM Inner door	1800 (70.87)	1000 (39.37)	NSYID1810
Spacial SF/SM Inner door	2000 (78.74)	600 (23.62)	NSYID206
Spacial SF/SM Inner door	2000 (78.74)	800 (31.50)	NSYID208
Spacial SF/SM Inner door	2000 (78.74)	1000 (39.37)	NSYID2010
Spacial SF/SM Inner door	2200 (86.61)	600 (23.62)	NSYID226
Spacial SF/SM Inner door	2200 (86.61)	800 (31.50)	NSYID228

SF Side Door



NSYSFD126

- Door for all sides of the enclosure, replaces the side panel.
- Installation directly on the structure of the enclosure, opening 120°.
- Lock with handle and 5 (0.20) mm (in.) double-bar insert.
- 4 locking points.
- Reinforcement frame, cut-out with a pitch of 25 (0.98) mm (in.)
- Opening to right or left.
- Material: Steel
- Finish: Structured finish, epoxy polyester powder
- Color: RAL 7035 grey

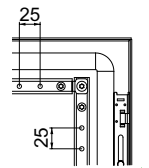

Comment:
For dimensions see [page 133](#)

Supply:
One side door, four hinges, four catches and handle lock

Characteristics	Height mm (in.)	Width mm (in.)	References
Spacial SF Side door	1200 (47.24)	600 (23.62)	NSYSFD126
Spacial SF Side door	1200 (47.24)	800 (31.50)	NSYSFD128
Spacial SF Side door	1400 (55.12)	600 (23.62)	NSYSFD146
Spacial SF Side door	1400 (55.12)	800 (31.50)	NSYSFD148
Spacial SF Side door	1600 (62.99)	600 (23.62)	NSYSFD166
Spacial SF Side door	1600 (62.99)	800 (31.50)	NSYSFD168
Spacial SF Side door	1800 (70.87)	400 (15.75)	NSYSFD184
Spacial SF Side door	1800 (70.87)	500 (19.68)	NSYSFD185
Spacial SF Side door	1800 (70.87)	600 (23.62)	NSYSFD186
Spacial SF Side door	1800 (70.87)	800 (31.50)	NSYSFD188
Spacial SF Side door	2000 (78.74)	300 (11.81)	NSYSFD203
Spacial SF Side door	2000 (78.74)	400 (15.75)	NSYSFD204
Spacial SF Side door	2000 (78.74)	500 (19.68)	NSYSFD205
Spacial SF Side door	2000 (78.74)	600 (23.62)	NSYSFD206
Spacial SF Side door	2000 (78.74)	700 (27.56)	NSYSFD207
Spacial SF Side door	2000 (78.74)	800 (31.50)	NSYSFD208
Spacial SF Side door	2200 (86.61)	400 (15.75)	NSYSFD224
Spacial SF Side door	2200 (86.61)	500 (19.68)	NSYSFD225
Spacial SF Side door	2200 (86.61)	600 (23.62)	NSYSFD226
Spacial SF Side door	2200 (86.61)	800 (31.50)	NSYSFD228

Partial doors

Front fix panel for modularity

- Top and bottom fix panel to obtain modularity required to install partial doors.
- It is needed to purchase **NSYMIC6** and **NSYMIC8**.
- Height 100 (3.94) mm (in.) fixed panels are delivered as standard for the compartmentalized enclosure, Spacial SFM.
- Possibility to order it separately for Spacial SF framework in kit supply.
- Available in 2 heights.
- Ingress protection rating: IP54 according to IEC 60529



Characteristics	Height mm (in.)	Width mm (in.)	References
Spacial SFM - Front Fix panel for modularity	100 (3.94)	600 (23.62)	NSYMF2M6
Spacial SFM - Front Fix panel for modularity	250 (9.84)	600 (23.62)	NSYMF5M6
Spacial SFM - Front Fix panel for modularity	100 (3.94)	800 (31.50)	NSYMF2M8
Spacial SFM - Front Fix panel for modularity	250 (9.84)	800 (31.50)	NSYMF5M8

Frontal partial doors

- Plain partial door with lock 5 (0.20) mm (in.) double-bar insert.
- They are fixed to the uprights of the framework by means of hinges.
- Drilling template for uprights ref. **NSYMDT** (only one drilling template required per order).
- Opening to right or left.
- 1, 2 or 4 locking points depending on height
- Possibility to replace locking insert.
- Available in following heights.
- Ingress protection rating: IP54 according to IEC 60529



Characteristics	Height mm (in.)	Width mm (in.)	References
Spacial SFM Frontal partial door	150 (5.91)	600 (23.62)	NSYMPD3M6
Spacial SFM Frontal partial door	200 (7.87)	600 (23.62)	NSYMPD4M6
Spacial SFM Frontal partial door	250 (9.84)	600 (23.62)	NSYMPD5M6
Spacial SFM Frontal partial door	300 (11.81)	600 (23.62)	NSYMPD6M6
Spacial SFM Frontal partial door	400 (15.75)	600 (23.62)	NSYMPD8M6
Spacial SFM Frontal partial door	450 (17.72)	600 (23.62)	NSYMPD9M6
Spacial SFM Frontal partial door	600 (23.62)	600 (23.62)	NSYMPD12M6
Spacial SFM Frontal partial door	800 (31.50)	600 (23.62)	NSYMPD16M6
Spacial SFM Frontal partial door	900 (35.43)	600 (23.62)	NSYMPD18M6
Spacial SFM Frontal partial door	1000 (39.37)	600 (23.62)	NSYMPD20M6
Spacial SFM Frontal partial door	1200 (47.24)	600 (23.62)	NSYMPD24M6
Spacial SFM Frontal partial door	150 (5.91)	800 (31.50)	NSYMPD3M8
Spacial SFM Frontal partial door	200 (7.87)	800 (31.50)	NSYMPD4M8
Spacial SFM Frontal partial door	250 (9.84)	800 (31.50)	NSYMPD5M8
Spacial SFM Frontal partial door	300 (11.81)	800 (31.50)	NSYMPD6M8
Spacial SFM Frontal partial door	400 (15.75)	800 (31.50)	NSYMPD8M8
Spacial SFM Frontal partial door	450 (17.72)	800 (31.50)	NSYMPD9M8
Spacial SFM Frontal partial door	600 (23.62)	800 (31.50)	NSYMPD12M8
Spacial SFM Frontal partial door	800 (31.50)	800 (31.50)	NSYMPD16M8
Spacial SFM Frontal partial door	900 (35.43)	800 (31.50)	NSYMPD18M8
Spacial SFM Frontal partial door	1000 (39.37)	800 (31.50)	NSYMPD20M8
Spacial SFM Frontal partial door	1200 (47.24)	800 (31.50)	NSYMPD24M8

Frontal transparent partial doors

- Glazed (Securit glass) partial door with lock 5 (0.20) mm (in.) double-bar insert.
- They are fixed to the uprights of the framework by means of hinges.
- Opening to right or left.
- 1 or 2 locking points according different heights.
- Available in following heights.
- Ingress protection rating: IP54 according to IEC 60529



Characteristics	Height mm (in.)	Width mm (in.)	References
Spacial SFM Frontal Transparent partial doors	200 (7.87)	600 (23.62)	NSYMPD26T
Spacial SFM Frontal Transparent partial doors	400 (15.75)	600 (23.62)	NSYMPD46T
Spacial SFM Frontal Transparent partial doors	600 (23.62)	600 (23.62)	NSYMPD66T
Spacial SFM Frontal Transparent partial doors	800 (31.50)	600 (23.62)	NSYMPD86T
Spacial SFM Frontal Transparent partial doors	1000 (39.37)	600 (23.62)	NSYMPD106T
Spacial SFM Frontal Transparent partial doors	200 (7.87)	800 (31.50)	NSYMPD28T
Spacial SFM Frontal Transparent partial doors	400 (15.75)	800 (31.50)	NSYMPD48T
Spacial SFM Frontal Transparent partial doors	600 (23.62)	800 (31.50)	NSYMPD68T
Spacial SFM Frontal Transparent partial doors	800 (31.50)	800 (31.50)	NSYMPD88T
Spacial SFM Frontal Transparent partial doors	1000 (39.37)	800 (31.50)	NSYMPD108T

Technical changes reserved. Information provided without guarantee. Images are for illustrative purposes only.

Intermediate crossbar



- Mounted between partial doors or between doors and control desk, guaranteeing IP54 according to IEC 60529.
- Crossbar with direct fixing to the structure.
- Available in 2 widths.



Supply:
2 crossbars with fixing elements.

Characteristics	Width mm (in.)	References
Spacial SF-Intermediate Crossbar	600 (23.62)	NSYMIC6
Spacial SF-Intermediate Crossbar	800 (31.50)	NSYMIC8

Folding panel



- Height 300 (118.11) mm (in.) horizontal panel, hinged at the top.
- Helps guarantee protection of the sets of bars.
- Opening angle: 110°.
- It is installed together with partial doors to create the modularity of the enclosure.
- 2 locking points, 5 (0.20) mm (in.) double-bar insert.
- Available in 2 widths.

Characteristics	Width mm (in.)	References
Spacial SF Folding panel	600 (23.62)	NSYCDP36
Spacial SF Folding panel	800 (31.50)	NSYCDP38

Control desk



- Support for human-machine interface.
- Height 400 (157.48) mm (in.) Control desk is installed together with partial doors to create the modularity of the enclosure.
- 2 locking points, 5 (1.97) mm (in.) double-bar insert.
- Available in 2 widths.

Characteristics	Width mm (in.)	References
Spacial SF Control desk	600 (23.62)	NSYCOD264
Spacial SF Control desk	800 (31.50)	NSYCOD284

Metal document pocket



- Direct mounting on the reinforcement frame of the door.
- Adjustable depth with a pitch of 25 (0.98) mm (in.)
- Material: Steel
- Finish: Structured finish, epoxy polyester powder
- Color: RAL 7035 grey

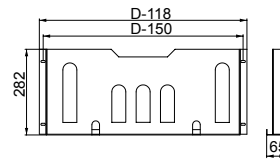

Supply:
1 metal document pocket and fixing elements

Characteristics	(D) Width mm (in.)	References
Spacial SF/SM Metal document pocket	600 (23.62)	NSYSDP6M
Spacial SF/SM Metal document pocket	800 (31.50)	NSYSDP8M

Plastic document pocket



- Attachment by adhesive tape.
- Material: Polystyrene (PS)
- Color: RAL 7035 grey (**NSYDPA4**: RAL 9001)

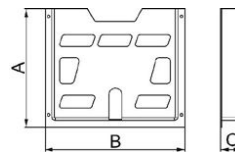

Comment:
NSYDPA44 not compatible with 19" chassis or modular distribution.

Supply:
1 plastic document pocket

Characteristics	Doc. format	A mm (in.)	B mm (in.)	C mm (in.)	References
Spacial SF/SM Plastic document pocket	A5	174 (6.85)	188 (7.40)	22 (0.87)	NSYDPA5
Spacial SF/SM Plastic document pocket	A4	230 (9.06)	247 (9.72)	23 (0.91)	NSYDPA4
Spacial SF/SM Plastic document pocket	A4	234 (9.21)	278 (10.94)	40 (1.58)	NSYDPA44
Spacial SF/SM Plastic document pocket	A3	285 (11.22)	476 (18.74)	35 (1.38)	NSYDPA3

Folding support tray



NSYSDT5

- Adjustable horizontal support for laptop computers, documents or any other element.
- Installation on the reinforcement frame of the door.
- Can also be installed on the door cross-rails, see [page 299](#).
- 4 positions: 45°, 60°, 75° and 90°.
- Maximum load: 30 (1.18) mm
- Material: Steel
- Finish: Structured finish, epoxy polyester powder
- Color: RAL 7035 grey

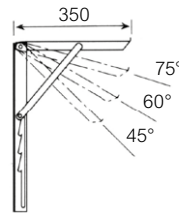

Supply:
1 folding support tray and fixing elements

Characteristics	Width of enclosure mm (in.)	Width of tray mm (in.)	References
Spacial SF/SM-Folding support tray	500 (19.68)	325 (12.80)	NSYSDT5
Spacial SF/SM-Folding support tray	600 (23.62)	425 (16.73)	NSYSDT6
Spacial SF/SM-Folding support tray	800 (31.50)	625 (24.61)	NSYSDT8



NSYSDT8

180° hinge

- Hinge with opening of 180°.
- Intended to replace the 120° hinges installed as standard.
- They are compatible with the transparent door and can be installed even with enclosure suites.
- Maximum load: 60 (132.28) kg (lbs.) on the door
- Material: Aluminum and zamak
- Finish: Painted RAL 9005 black
- NEMA Types:
 - SF: NEMA Type 1, 3R and 12
 - SM single-door: NEMA Type 1, 2, 3, 3R, 5, 12 and 13



Supply:
4 hinges

Characteristics	References
Spacial SF/SM 180° hinge	NSYSH180NC



NSYSH180NC

Door-centering caster



NSYSDRC

- Allows the door to be raised when closing.
- Direct mounting on the reinforcement frame.
- Maximum load: 90 (198.42) kg (lbs.)

Supply:
One centering roller and fixing elements

Characteristics	References
Spacial SF/SM Door-centering caster	NSYSDRC

Door switch



NSYDCM20

- The switch is fixed to the structure of the enclosure.
- Drilled M20 cable entry for cable gland.
- NC + NO contact, 240 V AC / 3 A (IEC 60947-5-1)
250 V DC / 0,1 A (IEC 60947-5-1)



Supply:
1 door switch and fixing elements

Characteristics	References
Spacial SF/SFX Door switch	NSYDCM20
Spacial SM Door switch	NSYMDCM20

Locking system Padlock locking



NSYBLKH123

- Padlock locking system, for installation in all the handles of the Spacial SF and Spacial SM enclosures.
- Screw with 7,5 (0.30) mm (in.) drill hole.



Supply:
One cut-out handle, screw for padlock and screw fixing screw

Characteristics	References
Spacial SF/SM Padlock locking	NSYBLKH123

CNOMO kit



NSYCNOH123

- Locking system to be installed on the central locking bar of the door.
- It works as a locking bar immobiliser, helping prevent the handle from closing while the door is still open.
- It is compatible with all handle lock versions, except the flat lock and the small flat lock.



Supply:
One mechanism and fixing elements

Characteristics	References
Spacial SF/SM CNOMO kit	NSYCNOH123

Push-button handle with 3524E key



NSYSFHPB

- Push-button handle with 3524E key for Spacial SF and Spacial SM enclosures.
- Locking and unlocking by key and opening by pushing the insert.
- Handle material: Polyamide 6 with 30% fiberglass
- Color: RAL 9005
- Fire resistant: 650°C (1202°F)

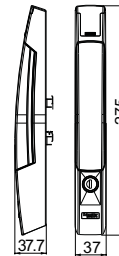

Supply:
Push-button handle, two 3524E keys and fixing elements (insert included)

Characteristics	References
Spacial SF/SM Push-button handle with 3524E key	NSYSFHPB

Handle for shaped inserts and cylindrical barrels



NSYSFHS1

- Easy to change the opening direction of the door, right/left.
- Space reserved for enclosure identification, 21 (0.83) x 27 (1.06) mm (in.), protected by a label frame.
- Handle material: Polyamide 6 with 30% fiberglass
- Color: RAL 9005
- Mechanical protection rating: IK10 according to IEC 62262
- Fire resistant: 650°C (1202°F)

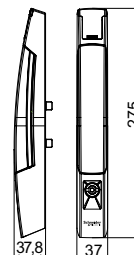

Supply:
Standard handle and fixing elements (insert not included)

Characteristics	References
Spacial SF/SM Handle for shape inserts and cylindrical barrels	NSYSFHS1

Push-button



NSYINPULS1

Characteristics	References
Push-button	NSYINPULS1

Shape inserts

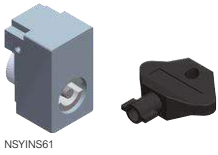

NSYINS61

Characteristics	References
6 (0.24) mm (in.) square insert	NSYINS61
7 (0.28) mm (in.) square insert	NSYINS71
8 (0.32) mm (in.) square insert	NSYINS81
Female 8 (0.32) mm (in.) square insert	NSYINS8G1
6,5 (0.26) mm (in.) triangular insert	NSYINT61
7 (0.28) mm (in.) triangular insert	NSYINT71
8 (0.32) mm (in.) triangular insert	NSYINT81
9 (0.35) mm (in.) triangular insert	NSYINT91
10 (0.39) mm (in.) triangular insert	NSYINT101
3 (0.12) mm (in.) double-bar insert	NSYINDB31
5 (0.20) mm (in.) double-bar insert	NSYINDB51

Cylindrical barrels

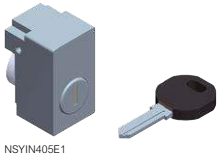

NSYIN405E1

Characteristics	References
405E key lock	NSYIN405E1
421E key lock	NSYIN421E1
455 key lock	NSYIN4551
1242E key lock	NSYIN1242E1
1332E key lock	NSYIN1332E1
2124E key lock	NSYIN2124E1
2131A key lock	NSYIN2131A1
2132A key lock	NSYIN2132A1
2331A key lock	NSYIN2331A1
2433A key lock	NSYIN2433A1
2452E key lock	NSYIN2452E1
3113A key lock	NSYIN3113A1
3122E key lock	NSYIN3122E1
3123A key lock	NSYIN3123A1
3131A1 key lock	NSYIN3131A1
3133A key lock	NSYIN3133A1
3422E key lock	NSYIN3422E1
3432E key lock	NSYIN3432E1
6101 key lock	NSYIN6101
EDF1300 key lock	NSYINF1301
EDF1400 key lock	NSYINF1401
Michelin 8133 keyless lock	NSYINICHEL8131
Michelin 8376 keyless lock	NSYINICHEL8371
E1 keyless lock	NSYINE11

Flat escutcheon lock



NSYSFLOCK24



NSYSFLOCKT8



NSYSFLOCKT7



NSYSFLOCKT6



NSYSFLOCKSG8



NSYSFLOCKS8



NSYSFLOCKS7



NSYSFLOCKS6



NSYSFLOCKDB5

- Optional flat escutcheon lock. Replaces the handle lock.
- Easy to change the opening direction of the door, right/ left.
- Option of changing the turning direction of the insert.
- Handle material: Polyamide 6 with 30% fiberglass
- Color: RAL 9005
- Mechanical protection rating: IK10 according to IEC 62262
- Fire resistance: 650 °C

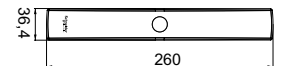

Supply:
Flat lock, shape insert, key and fixing elements

Characteristics	References
Flat lock + screwdriver slot, 2 mm groove	NSYSFLOCK24
Flat lock + 8 mm triangular insert	NSYSFLOCKT8
Flat lock + 7 mm triangular insert	NSYSFLOCKT7
Flat lock + 6.5 mm triangular insert	NSYSFLOCKT6
Flat lock + 8 mm female square insert	NSYSFLOCKSG8
Flat lock + 8 mm square insert	NSYSFLOCKS8
Flat lock + 7 mm square insert	NSYSFLOCKS7
Flat lock + 6 mm square insert	NSYSFLOCKS6
Flat lock + 5-mm double-bar insert	NSYSFLOCKDB5

Technical changes reserved. Information provided without guarantee. Images are for illustrative purposes only.

Handles for insert types DIN, KABA, ASSA, Insert handle



NSYSFHD2

- The inserts are easily and quickly mounted without any screws and allow the installation of profiled DIN, KABA and ASSA locks.
- To install shape inserts or cylindrical barrels, it is necessary to add adapter ref. **NSYLADP**.
- Easy to change the opening direction of the door, right/left.
- Space reserved for enclosure identification, 21 (0.83) x 27 (1.06) mm (in.), protected by a label frame.
- Handle material: Polyamide 6 with 30% fiberglass
- Color: RAL 9005
- Mechanical protection rating: IK10 according to IEC 62262
- Fire resistant: 650°C (1202°F)

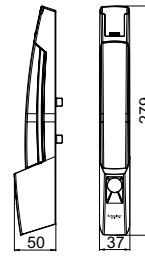

Supply:
One handle for DIN, KABA and ASSA inserts and fixing elements (insert not included)

Characteristics	References
Spacial SF/SM Insert handle	NSYSFHD2

Handles for insert types DIN, KABA, ASSA, double-insert handle



NSYSFHD3

- The double-insert handle can perform the "AND" and "OR" functions (are supplied with the handle).
- "AND" function: One insert blocks the activation of the other insert.
- "OR" function: Either insert can release the handle.
- Easy to change the opening direction of the door, right/left.
- Space reserved for enclosure identification, 21 (0.83) x 27 (1.06) mm (in.), protected by a label frame.
- To install shape inserts or cylindrical barrels, it is necessary to add adapter ref. **NSYLADP**.
- Handle material: Polyamide 6 with 30% fiberglass
- Color: RAL 9005
- Mechanical protection rating: IK10 according to IEC 62262
- Fire resistant: 650°C (1202°F)

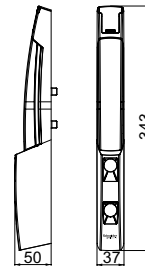

Supply:
One handle for DIN, KABA and ASSA inserts and fixing elements (insert not included)

Characteristics	References
Spacial SF/SM Double-insert handle	NSYSFHD3

Lock system: DIN, KABA and ASSA



NSYINDIN2



NSYIN1242E2

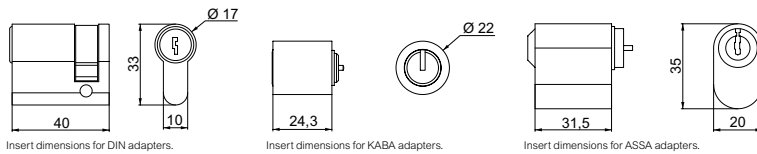

Comment:
NSYINKBA2: Adapter for receiving the KABA8, KABA20 and KABA start cylinders.

Characteristics	References
Spacial SF/SM Adapter for DIN cylinder	NSYINDIN2
Spacial SF/SM Adapter for KABA cylinder	NSYINKBA2
Spacial SF/SM Adapter for ASSA cylinder	NSYINASSA2
Spacial SF/SM 1242E key lock	NSYIN1242E2
Spacial SF/SM Reinforced key lock	NSYINKR2
Spacial SF/SM JIS key lock	NSYINKJIS2
Spacial SF/SM FAC key lock	NSYINKFAC2

Adapter for shape inserts and cylindrical barrels



NSYLADP

- Plastic adapter for installing shape inserts and cylindrical barrels in handle lock types DIN, KABA, ASSA.
- See shape inserts and cylindrical barrels.
- See insert types DIN, KABA, ASSA.

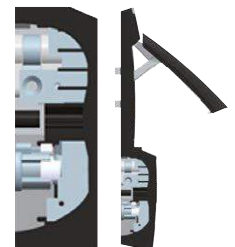

Supply:
1 unit

Characteristics	References
Spacial SF/SM Adapter for shape inserts and cylindrical barrels	NSYLADP

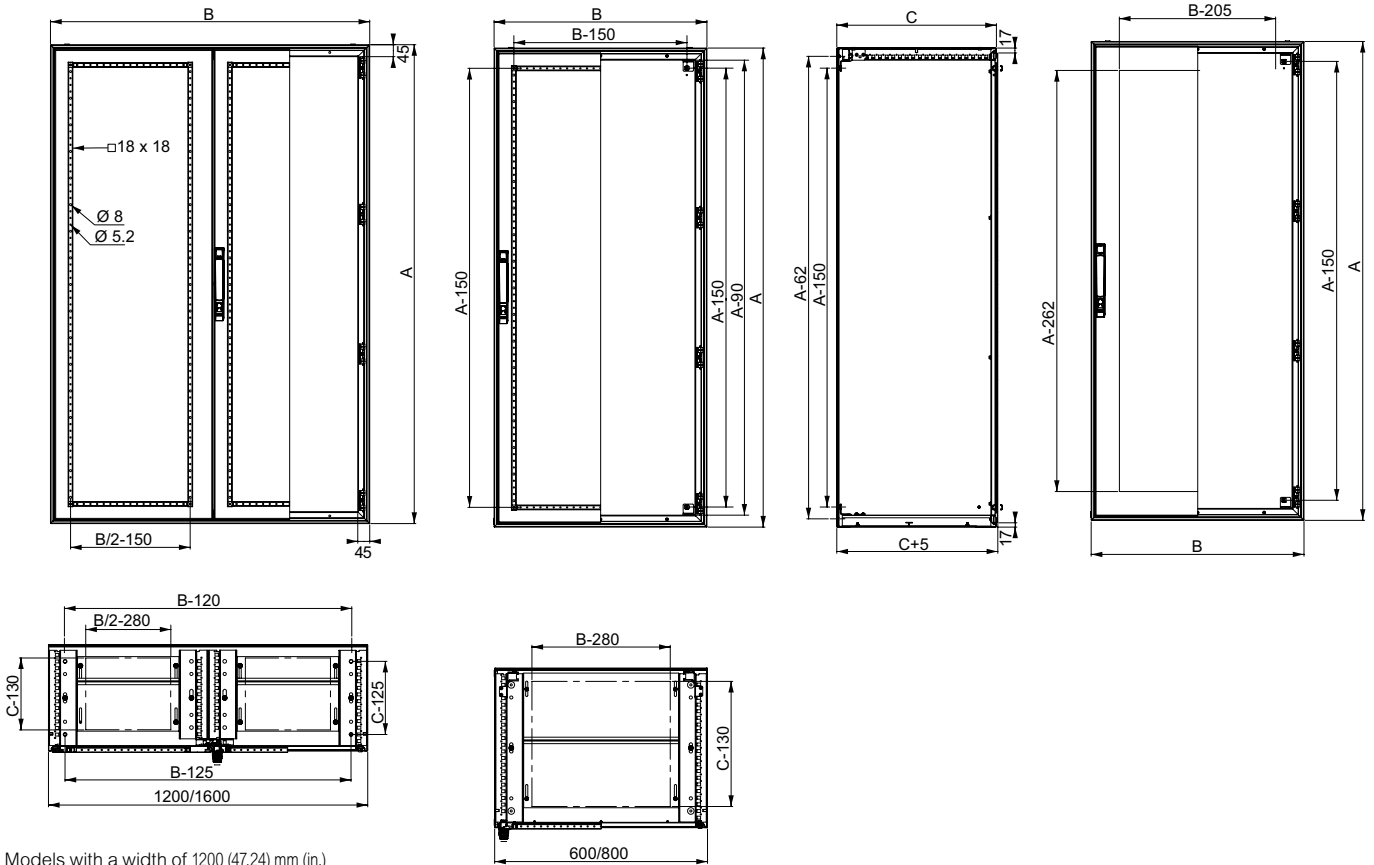

Models with a width of 1200 (47.24) mm (in.) without top/bottom adjustment rails

Inner door

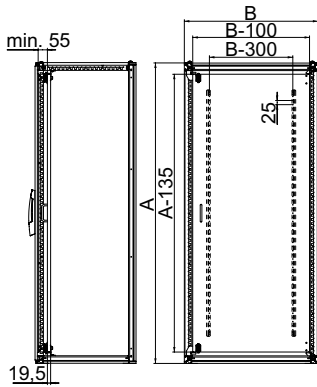

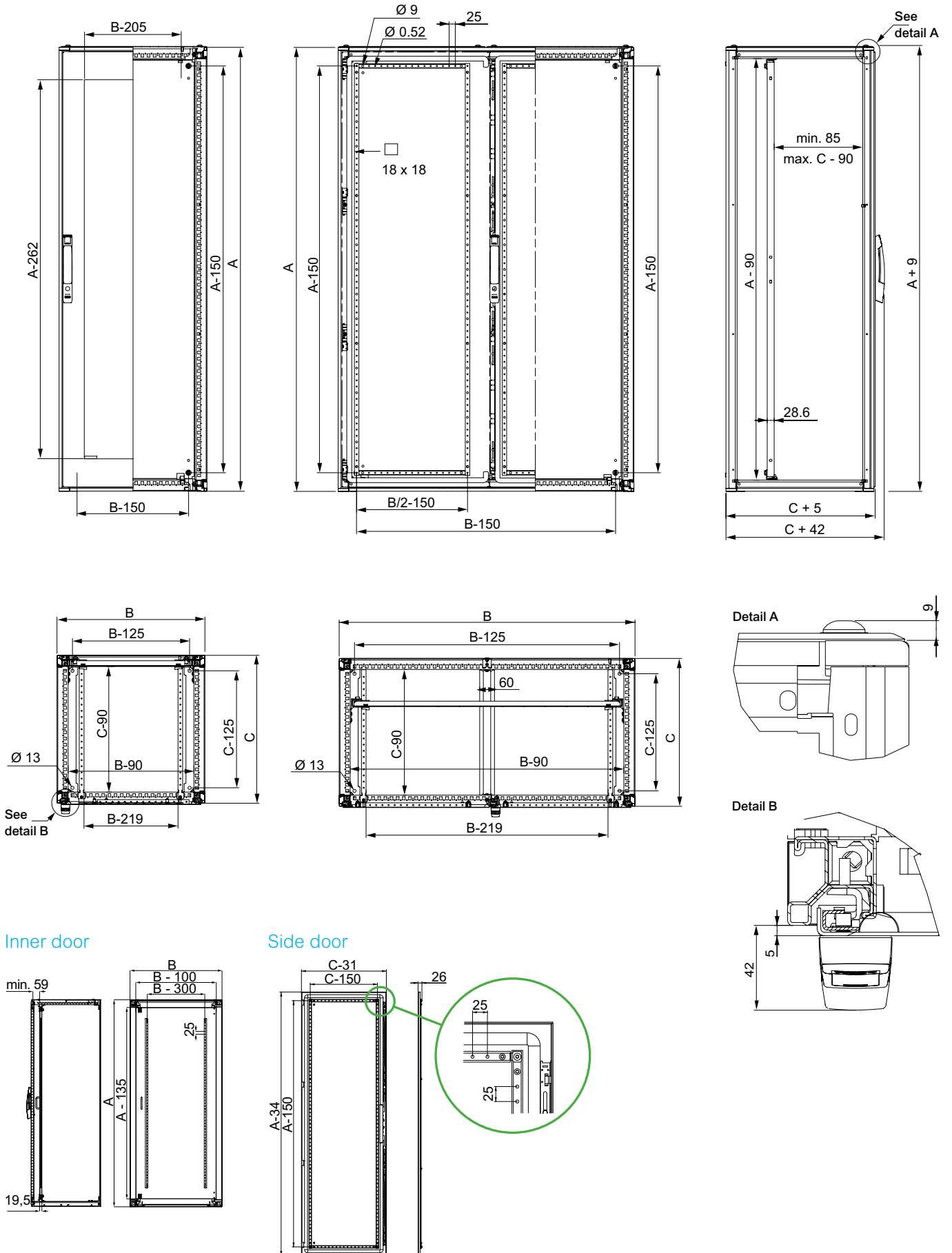

Technical changes reserved. Information provided without guarantee. Images are for illustrative purposes only.

Stainless-Steel Industrial Boxes

Spacial SBX

4



Spacial SBX

Introduction	136
Characteristics	139
Accessories	140
Dimensions	144

What is stainless-steel?

How is the grade of stainless-steel determined?

These enclosures have been specially designed for the chemical, oil and food and beverage industries, among others, which are particularly demanding in terms of hygiene and resistance to corrosion.

Elaborate material composition

The following table shows the percentages of the main alloy elements that make up stainless-steels. The resistance of the material to aggressive agents in the environment depends mainly on these alloys.



4

Choosing a grade

Stainless-steel type		Chemical composition (%)			
AISI grade	N. Europe	Carbon	Chromium	Nickel	Molybdenum
304L	1.4307	< 0.03	17 - 19	8 - 10	0
316L	1.4404	< 0.03	17 - 19	10 - 13	2 - 2.25



AISI 304L stainless-steel

The most commonly used type in the food and beverage industry because of its resistance to corrosion and ease of cleaning.

- Prevention against corrosion, especially in the presence of organic acids.
- Resistance to the effects of nitrous gas in the presence of condensed water and in most aggressive environments.



AISI 316L stainless-steel

Recommended in salty or chlorinated environments because of its very high resistance to corrosion created by molybdenum.

- Improved resistance to corrosion.
- Particularly well adapted to environments with acidity, bromine and saline halides or very corrosive additives and solvents.

The finish

The finish: Three solutions for protection against aggressive substances

Surface condition plays an important role in the fight against bacteria. The lower the roughness, the fewer bacteria become incrustated. Reduced roughness means fewer bacteria, less adhesion, and a finish that's impeccable. The choice of finish determines the appearance of the enclosures that matches the environment of other machines and equipment.



Solution 1: Scotch-Brite® brushing

The method uses brushing as defined by the ASTM (American Society for Testing and Material).

- Finish very commonly used for the chemical and food and beverage industries.
- Surface roughness is improved thanks to an additional polishing process which offers more efficient characteristics against polluting elements.
- Surface roughness: $Ra \leq 0.8 \mu m$.



Solution 2: Micro-beading (on request)

Exclusiveness, an impeccable finish with silky-smooth appearance.

The method:

- Bombardment with miniscule ceramic balls of the entire surface to be treated at very high speed.
- Closes micro-cracks caused during lamination by flattening the surface.

The result:

- Increased hardness.
- Reduced surface roughness: $Ra \approx 0.8 \mu m$.
- A perfectly even surface, with a silky appearance (no scratches and no burrs).
- Reduces the adhesion of materials.
- Allows disinfection.
- Typical application: Pharmaceutical and food and beverage industries.

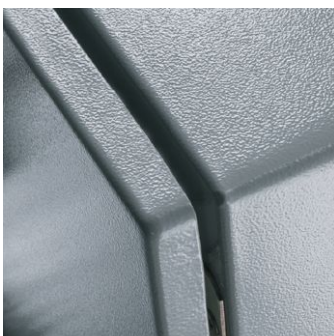

Solution 3: Protective coating (on request)

The highest protection against aggressive substances, external pollution and projections of metal particles.

- Provides ultimate protection against corrosion.
- Typical applications: Marine, seaside, off-shore.

Simplicity, ergonomics and quality.

4



Selection

- 6 sizes
- 80 (31.50) mm (in.) and 120 (47.24) mm (in.) in depth.



Sturdy with high ingress protection

- Thickness of 1.2 (0.47) mm (in.)
- Mechanical protection rating up to IK10.
- Ingress protection rating up to IP66.



Added-value for your work to your Work

- Quality and esthetics.
- Same dimensions as steel boxes (SBM range).
- Mounting with versatile external brackets.
- Certification (on request): UL, Veritas and BVM.



Ergonomics

- Cover opening and accessory mounting with just a screwdriver.



For details consult our web site
www.se.com



Characteristics	Spacial SBX Flat box
	<p>Box with plain faces Single-piece body (rectangular structure). Front design incorporating folded gutters. Flat rear. 2 drilled profiles for installing mounting plates and DIN rails, with mounting centers of 12.5 (4.92) mm (in.). Equipped with 4 half-turn thread screws to help ensure maximum watertightness. Polyurethane sealing gasket.</p> <p>Protection of personnel Earthing connection mandatory for all boxes: Spacial SBX Stainless-Steel boxes are equipped with an M6 x 10 (0.39) mm (in.) earthing stud welded on the cover, to be linked with the body for equipotential connection. Earthing braid to be ordered separately (Ø 6,4 (0.25) mm (in.) terminal).</p>
Material	AISI 304L stainless-steel, thickness of 1,2 (0.05) mm (in.)
Finish	Scotch-Brite® brushed.
Ingress protection rating	IP66
Mechanical protection rating	IK10
Compliance with standards	IEC 62208 and the RoHS directive.
Certifications	<ul style="list-style-type: none"> • UL, BV, BVM • NEMA Type 4, 4X, 13 according to UL 508A standard • Fire class: M0
Installation	<p>Indoor installation Direct wall-mounted (4 x Ø 10 (0.39) mm (in.) holes with sealing plugs to maintain the IP rating) or with the help of fixing lugs installed from the outside (to be ordered separately, see the specific accessory pages). Distance between mounting holes enables the installation of the box in the same locations as many existing enclosures.</p> <p>Outdoor installation Compliant with IEC 62208 regarding type tests specified in §9.12 resistance to ultra-violet (UV) radiation and §9.13 resistance to corrosion. It is always advisable to place the box under shelter to avoid water stagnation on the upper part of the enclosure.</p>
Maximum load capacity	On the body: 50 (110.23) kg (lbs.)/m²
Other characteristics	<p>Vibration constraints Specific construction of the Spacial SBX - single-piece body (rectangular structure). The rear is flat without added parts - this helps ensure compliance with certain vibration constraints. The tests were conducted according to the marine application by Bureau Veritas Marine.</p>



Dimensions			Box	Mounting plate	DIN rail	Fixing lugs	Sealing kit
Height mm (in.)	Width mm (in.)	Depth mm (in.)	Supply: 1 piece	Supply: 1 piece	Supply: 10 pieces	Supply: 4 pieces	Supply: 1 piece
References			References	References	References	References	References
150 (5.91)	150 (5.91)	80 (3.15)	NSYSBX15158	NSYMM11SB	NSYAMRD15357SB	NSYAEFPFSBX	NSYPPSB
150 (5.91)	300 (11.81)	80 (3.15)	NSYSBX15308	NSYMM13SB	NSYAMRD30357SB		
200 (7.87)	200 (7.87)	80 (3.15)	NSYSBX20208	NSYMM22SB	NSYAMRD20357SB		
200 (7.87)	300 (11.81)	80 (3.15)	NSYSBX20308	NSYMM23SB	NSYAMRD30357SB		
200 (7.87)	400 (15.75)	120 (4.72)	NSYSBX204012	NSYMM24SB	NSYAMRD40357SB		
300 (11.81)	300 (11.81)	120 (4.72)	NSYSBX303012	NSYMM33SB	NSYAMRD30357SB		

4

Mounting plate

- Material: Galvanized steel
- Installation: Mounting by means of 2* or 4 x Ø 5 (0.20) mm (in.) self-tapping screws, Pozidriv head, ref. **NSYAMFSB**. Mounting plate installation points compatible with many other brands of accessories.

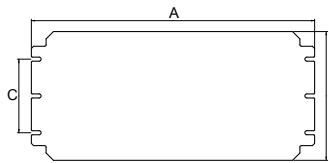

Comment:
* Only 2 screws for mounting plates with height of 150 (5.91) mm (in.)

Supply:
1 unit, supplied without screws

Characteristics	Dimensions		Mounting plate, Dimensions			Thickness mm (in.)	References
	Height mm (in.)	Width mm (in.)	A mm (in.)	B mm (in.)	C mm (in.)		
Mounting plate	150 (5.91)	150 (5.91)	135 (5.32)	135 (5.32)	-	1.5 (0.06)	NSYMM11SB
Mounting plate	150 (5.91)	300 (11.81)	135 (5.32)	285 (11.22)	-	1.5 (0.06)	NSYMM13SB
Mounting plate	200 (7.87)	200 (7.87)	185 (7.28)	185 (7.28)	100 (3.94)	1.5 (0.06)	NSYMM22SB
Mounting plate	200 (7.87)	300 (11.81)	185 (7.28)	285 (11.22)	100 (3.94)	1.5 (0.06)	NSYMM23SB
Mounting plate	200 (7.87)	400 (15.75)	185 (7.28)	385 (15.16)	100 (3.94)	2.0 (0.08)	NSYMM24SB
Mounting plate	300 (11.81)	300 (11.81)	185 (7.28)	185 (7.28)	200 (7.87)	1.5 (0.06)	NSYMM33SB

Symmetrical DIN rails 35 (1.38) x 7.5 (0.30) mm (in.)

- Material: Galvanized steel
- Installation: Mounting by means of 2 x Ø 5 (0.20) mm (in.) self-tapping screws, Pozidriv head, ref. **NSYAMFSB** (All boxes are delivered with 5 x Ø 5 (0.20) mm (in.) self-tapping screws).

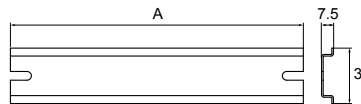

Supply:
10 rails, supplied without screws

Characteristics	Box Width mm (in.)	DIN rail Length A mm (in.)	References
Symmetrical DIN rail	150 (5.91)	135 (5.32)	NSYAMRD15357SB
Symmetrical DIN rail	200 (7.87)	185 (7.28)	NSYAMRD20357SB
Symmetrical DIN rail	300 (11.81)	285 (11.22)	NSYAMRD30357SB
Symmetrical DIN rail	400 (15.75)	385 (15.16)	NSYAMRD40357SB

Self-tapping screws



NSYAMFSB

- Same reference for all dimensions
- Self-tapping, Pozidriv head, screws, for Ø 5 (1.97) mm (in.) holes.

Supply:
100 units

Characteristics	References
Self-tapping screws	NSYAMFSB

Sealing kit



NSYPPSB

- The sealing kit helps to set up a lead-sealed cable of cover opening.
- Color: Green
- Ingress protection rating: IP66 according to IEC 60529
- Installation: Replaces the standard sealing washer on the box
- Same reference for all dimensions

Supply:
1 unit

Characteristics	References
Sealing kit SBM	NSYPPSB

Mounting lugs



NSYAEFFSBX

- Wall-mounted lugs to be mounted directly on the rear of the box, either in horizontal or vertical position. Their versatile design complies with the mounting dimensions of many other enclosures.
- Installation: Horizontal or vertical position, distance between wall and enclosure: 12 (0.47) mm (in.)
- Maximum load: 70 (154.32) kg (lbs.)

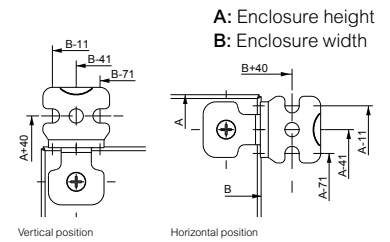

Supply:
4 wall-mounted lugs, screws and pre-mounted sealing gaskets

Characteristics	References
Wall-mounted lugs	NSYAEFFSBX



Synthetic snap-in cable gland

- Without thread.
- Easy assembly and disassembly.
- Suitable for walls from 0,5 (0.02) to 4 (0.16) mm (in.) thick.
- Material: PA6 Polyamide, neoprene gasket
- Color: RAL 7035 grey, RAL 7001, RAL 9005.
Other colors on demand
- Cable entry material: Non armoured
- Installation options:
On cable gland plate or directly on enclosure
- Flexibility of the installation: Low
- Reversibility: Medium
- Ingress protection rating: IP66
- Cable retention: High
- Cable diameter mm (in.): From 16 (0.63) to 40 (1.58)
- Cable Installation time: Slow
- Quantity of cables to be fitted for a given surface: +
- Cable entries for cables with connectors: No
- Thread type: Metric EN 60423
Other types are available on demand
- Cut-out dimensions mm (in.):
Various circular hole diameters according to cable diameter
- External dimensions mm (in.): From Ø 22 (0.87) to 46 (1.81)
- Certificates: UL 94 V-2 (except for the size M40)
- Standard: DIN EN 62444, UL 514B, UL 514B§8.26.7
- Temperature range: -20°C (-4°F) to + 100°C (212°F)

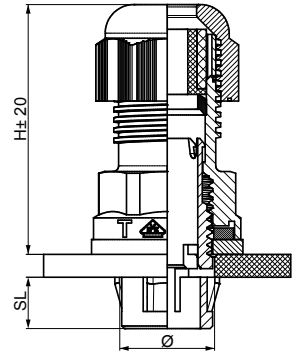

Supply:

The cable glands are supplied with nuts
Pack of 20 (M16 and M20), of 10 (M25 and M32), of 5 (M40)



NSYCGSP16

Characteristics	Dimensions							References
	Ø	Ø min / max	Drill Ø	SL	SD	H		
Synthetic snap-in cable gland	M16	5/10	16.2 to 16.4	9	15.9	42.5	22	NSYCGSP16
Synthetic snap-in cable gland	M20	6/12	20.2 to 20.4	9	19.9	41.5	24	NSYCGSP20
Synthetic snap-in cable gland	M25	11/17	25.2 to 25.4	9	24.9	43.5	29	NSYCGSP25
Synthetic snap-in cable gland	M32	15/21	32.2 to 32.4	9	31.9	49.5	36	NSYCGSP32
Synthetic snap-in cable gland	M40	19/28	40.2 to 40.4	11.5	39.9	56	46	NSYCGSP40

Stainless-steel cable gland with lamellar insert

- Lamellar technology provides excellent resistance to traction as well as excellent torsional protection. For aggressive environments.
- Material: Stainless-steel AISI 304L or AISI 316L, neoprene gasket
- Cable entry material: Non armoured
- Installation options:
 - On cable gland plate or directly on enclosure
- Flexibility of the installation: Low
- Reversibility: Medium
- Ingress protection rating: IP68
- Cable retention: High
- Cable diameter mm (in.): From 12 (0.47) to 40 (1.58)
- Cable Installation time: Slow
- Quantity of cables to be fitted for a given surface: +
- Cable entries for cables with connectors: No
- Thread type: Metric EN 60423

- Cut-out dimensions mm (in.): Various circular hole diameters according to cable diameter
- External dimensions mm (in.): From Ø 14 (0.55) to 43 (1.69)
- Certificates: UL 94 V-2
- Standard: DIN EN 62444, UL 514
- Temperature range: -20°C (-4°F) to + 100°C (212°F)



Supply:
The cable glands are supplied with nuts
Pack of 5 (M12 and M16), of 4 (M20 and M25), of 2 (M32 and M40)



NSYCGX12

Characteristics	Dimensions							References
	Ø	Ø min-max mm (in.)	Thread Length TL mm (in.)	SW Cap mm (in.)	SW Body mm (in.)	Outer Ø D mm (in.)	max. Height H mm (in.)	
AISI 304L	M12x1.5	3.0 (0.12) - 6.5 (0.26)	6 (0.24)	14 (0.55)	14 (0.55)	15.5 (0.61)	24 (0.94)	NSYCGX12
AISI 304L	M16x1.5	4.0 (0.16) - 8.0 (0.32)	7 (0.28)	17 (0.67)	19 (0.75)	21 (0.83)	25.5 (10.04)	NSYCGX16
AISI 304L	M20x1.5	10.0 (0.39) - 14.0 (0.55)	8 (0.32)	24 (0.94)	24 (0.94)	26.5 (10.43)	30 (1.18)	NSYCGX20
AISI 304L	M25x1.5	10.0 (0.39) - 14.0 (0.55)	8 (0.32)	24 (0.94)	27 (1.06)	30 (1.18)	30 (1.18)	NSYCGX25
AISI 304L	M32x1.5	13.0 (0.51) - 18.0 (0.71)	9 (0.35)	30 (1.18)	36 (1.42)	39.8 (15.67)	35 (1.38)	NSYCGX32
AISI 304L	M40x1.5	18.0 (0.71) - 25.0 (0.98)	9 (0.35)	41 (1.61)	46 (1.81)	51.4 (20.24)	40.5 (15.95)	NSYCGX40
AISI 316L	M12x1.5	3.0 (0.12) - 6.5 (0.26)	6 (0.24)	14 (0.55)	14 (0.55)	15.5 (0.61)	24 (0.94)	NSYCGX12H
AISI 316L	M16x1.5	4.0 (0.16) - 8.0 (0.32)	7 (0.28)	17 (0.67)	19 (0.75)	21 (0.83)	25.5 (10.04)	NSYCGX16H
AISI 316L	M20x1.5	10.0 (0.39) - 14.0 (0.55)	8 (0.32)	24 (0.94)	24 (0.94)	26.5 (10.43)	30 (1.18)	NSYCGX20H
AISI 316L	M25x1.5	10.0 (0.39) - 14.0 (0.55)	8 (0.32)	24 (0.94)	27 (1.06)	30 (1.18)	30 (1.18)	NSYCGX25H
AISI 316L	M32x1.5	13.0 (0.51) - 18.0 (0.71)	9 (0.35)	30 (1.18)	36 (1.42)	39.8 (15.67)	35 (1.38)	NSYCGX32H
AISI 316L	M40x1.5	18.0 (0.71) - 25.0 (0.98)	9 (0.35)	41 (1.61)	46 (1.81)	51.4 (20.24)	40.5 (15.95)	NSYCGX40H

Earth braids

- They help guarantee the earth connection for high frequencies, avoiding the disturbing electric currents that are produced.
- Material: Tinned copper.

Supply:
10 earth braids
(nuts and washers not included)
Reference by unit. Order by multiples of 10 (10, 20, 30...)



NSYEB156D6

Characteristics	Section (mm ²)	Terminal Ø mm (in.)	Length mm (in.)	Width mm (in.)	References
Earth braids	6 (0.24)	6.5 (0.26)	150 (5.91)	12 (0.47)	NSYEB156D6
Earth braids	10 (0.39)	6.5 (0.26)	150 (5.91)	17 (0.67)	NSYEB1510D6

Earth cables

- Make it easier to install a safe earth connection, with a perfect contact, with optimized length.
- Material: Brass and copper alloy terminal, green and yellow PVC insulated sheath

Supply:
10 earth cables (nuts and washers not included).
Reference by unit. Order by multiples of 10 (10, 20, 30...)



NSYEL136D6

Characteristics	Section (mm ²)	Terminal Ø mm (in.)	Length mm (in.)	References
Earth cables	6 (0.24)	6.4 (0.25)	130 (5.12)	NSYEL136D6
Earth cables	6 (0.24)	6.4 (0.25)	160 (6.30)	NSYEL166D6
Earth cables	6 (0.24)	8.3 (0.33)	160 (6.30)	NSYEL166D8
Earth cables	10 (0.39)	8.3 (0.33)	170 (6.69)	NSYEL1710D6
Earth cables	6 (0.24)	6.4 (0.25)	220 (8.66)	NSYEL226D6
Earth cables	6 (0.24)	13 (0.51)	220 (8.66)	NSYEL226D13
Earth cables	25 (0.98)	8.3 (0.33)	220 (8.66)	NSYEL2225D8
Earth cables	10 (0.39)	6.4 (0.25)	250 (9.84)	NSYEL2510D6
Earth cables	25 (0.98)	8.3 (0.33)	350 (13.78)	NSYEL3525D8

Earthing strip

- Perforated brass bar, 15 x 3 (0.12) mm (in.)
- 1 (0.04) mm (in.) long.
- 87 connection points, M5 drill holes

Supply:
• 1 earthing strip and fixing elements



NSYECB1M153

Characteristics	References
Earthing strip	NSYECB1M153

Technical changes reserved. Information provided without guarantee. Images are for illustrative purposes only.

Section A-A

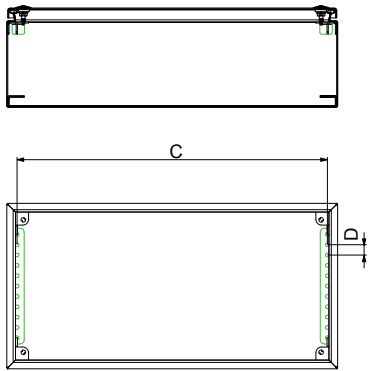

Section B-B

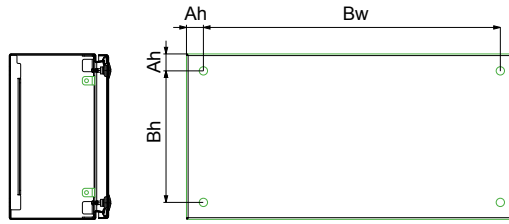

4

Dimensions	Height mm (in.)	Width mm (in.)	Depth mm (in.)	Sheet thickness mm (in.)	Box installation Ah mm (in.)	Bh mm (in.)	Bw mm (in.)	Mounting C mm (in.)	D mm (in.)
150 (5.91)	150 (5.91)	150 (5.91)	80 (3.15)	1.2 (0.05)	20.5 (0.81)	109 (4.29)	109 (4.29)	125 (4.92)	12.5 (0.49)
150 (5.91)	150 (5.91)	300 (11.81)	80 (3.15)	1.2 (0.05)	20.5 (0.81)	109 (4.29)	259 (10.20)	275 (10.83)	12.5 (0.49)
200 (7.87)	200 (7.87)	200 (7.87)	80 (3.15)	1.2 (0.05)	20.5 (0.81)	159 (6.26)	159 (6.26)	175 (6.89)	12.5 (0.49)
200 (7.87)	200 (7.87)	300 (11.81)	80 (3.15)	1.2 (0.05)	20.5 (0.81)	159 (6.26)	259 (10.20)	275 (10.83)	12.5 (0.49)
200 (7.87)	200 (7.87)	400 (15.75)	120 (4.72)	1.2 (0.05)	20.5 (0.81)	159 (6.26)	359 (14.13)	375 (14.76)	12.5 (0.49)
300 (11.81)	300 (11.81)	300 (11.81)	120 (4.72)	1.2 (0.05)	20.5 (0.81)	259 (10.20)	259 (10.20)	275 (10.83)	12.5 (0.49)

Cut-out zone limits

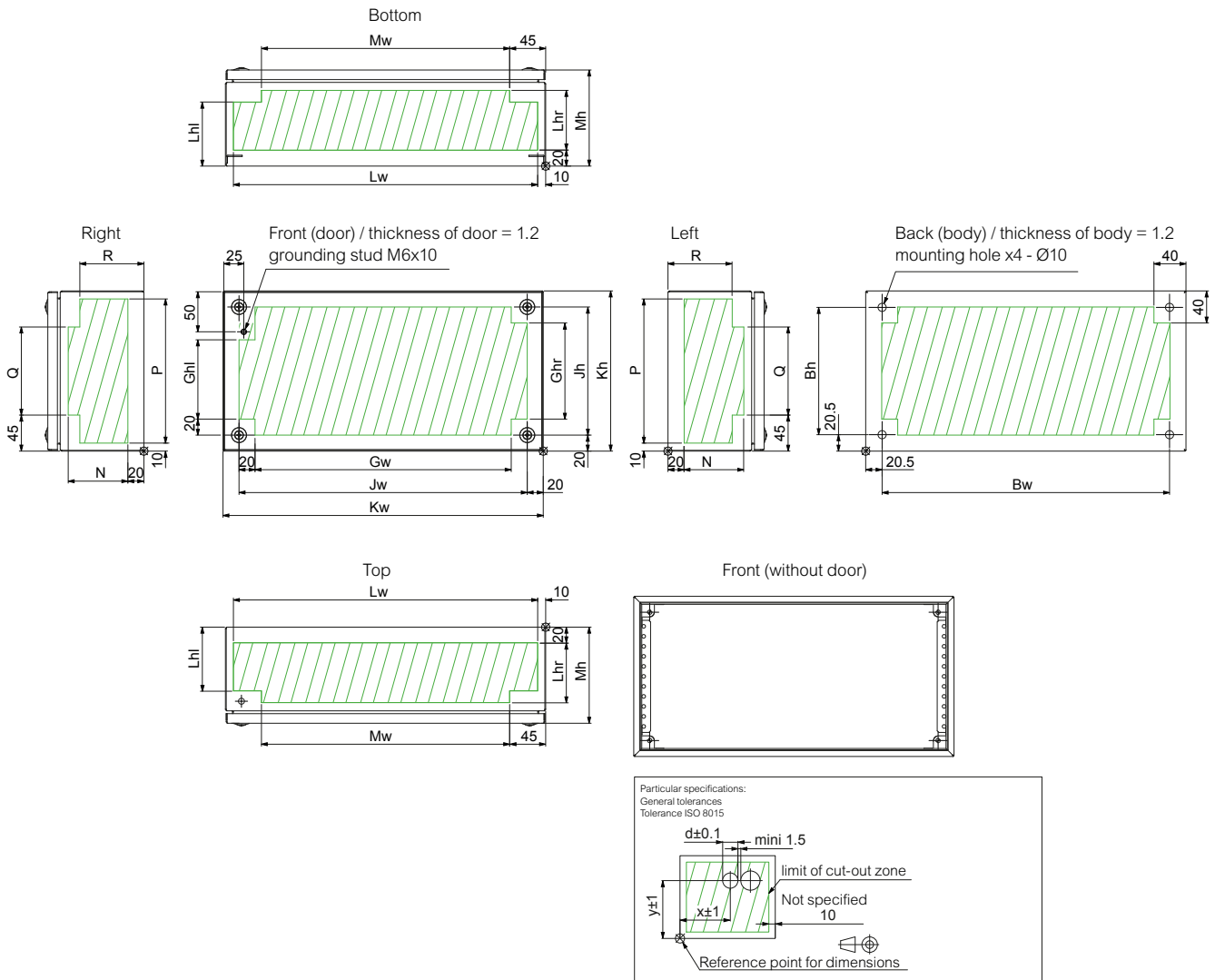

Dimensions			References	Dimensions of permissible cut-out zone																	
Height mm (in.)	Width mm (in.)	Depth mm (in.)		Bh mm (in.)	Bw mm (in.)	Ghr mm (in.)	Ghl mm (in.)	Gw mm (in.)	Jh mm (in.)	Jw mm (in.)	Kh mm (in.)	Kw mm (in.)	Lhl mm (in.)	Lhr mm (in.)	Lw mm (in.)	Mh mm (in.)	Mw mm (in.)	N mm (in.)	P mm (in.)	Q mm (in.)	R mm (in.)
150 (5.91)	150 (5.91)	80 (3.15)	NSYSBX15158	109 (4.29)	109 (4.29)	70 (2.76)	49 (1.93)	70 (2.76)	110 (4.33)	110 (4.33)	150 (5.91)	150 (5.91)	40 (1.58)	34.5 (1.36)	130 (5.12)	80 (3.15)	60 (2.36)	34.5 (1.36)	130 (5.12)	60 (2.36)	40 (1.58)
150 (5.91)	300 (11.81)	80 (3.15)	NSYSBX15308	109 (4.29)	259 (10.20)	70 (2.76)	49 (1.93)	220 (8.66)	110 (4.33)	260 (10.24)	150 (5.91)	300 (11.81)	40 (1.58)	34.5 (1.36)	280 (11.02)	80 (3.15)	210 (8.27)	34.5 (1.36)	130 (5.12)	60 (2.36)	40 (1.58)
200 (7.87)	200 (7.87)	80 (3.15)	NSYSBX20208	159 (6.26)	159 (6.26)	120 (4.72)	99 (3.90)	120 (4.72)	160 (6.30)	160 (6.30)	200 (7.87)	200 (7.87)	40 (1.58)	34.5 (1.36)	180 (7.09)	80 (3.15)	110 (4.33)	34.5 (1.36)	180 (7.09)	110 (4.33)	40 (1.58)
200 (7.87)	300 (11.81)	80 (3.15)	NSYSBX20308	159 (6.26)	259 (10.20)	120 (4.72)	99 (3.90)	220 (8.66)	160 (6.30)	260 (10.24)	200 (7.87)	300 (11.81)	40 (1.58)	34.5 (1.36)	280 (11.02)	80 (3.15)	210 (8.27)	34.5 (1.36)	130 (5.12)	60 (2.36)	40 (1.58)
200 (7.87)	400 (15.75)	120 (4.72)	NSYSBX204012	159 (6.26)	359 (14.13)	120 (4.72)	99 (3.90)	320 (12.60)	160 (6.30)	360 (14.17)	200 (7.87)	400 (15.75)	80 (3.15)	74.5 (2.93)	380 (14.96)	120 (4.72)	310 (12.20)	74.5 (2.93)	180 (7.09)	110 (4.33)	80 (3.15)
300 (11.81)	300 (11.81)	120 (4.72)	NSYSBX303012	259 (10.20)	259 (10.20)	220 (8.66)	199 (7.84)	220 (8.66)	260 (10.24)	260 (10.24)	300 (11.81)	300 (11.81)	80 (3.15)	74.5 (2.93)	280 (11.02)	120 (4.72)	210 (8.27)	74.5 (2.93)	280 (11.02)	210 (8.27)	80 (3.15)

Stainless-Steel Wall-Mounted Enclosures

Stainless-steel wall-mounted enclosures



5

Spacial S3X, Stainless-steel wall-mounted enclosures

Introduction	148
Characteristics	150
Selection guide	152
Accessories	153
Dimensions	157

What is stainless-steel?

How is the grade of stainless-steel determined?

These enclosures have been specially designed for the chemical, oil and food and beverage industries, among others, which are particularly demanding in terms of hygiene and resistance to corrosion.

Elaborate material composition

The following table shows the percentages of the main alloy elements that make up stainless-steels. The resistance of the material to aggressive agents in the environment depends mainly on these alloys.



5

Choosing a grade

Stainless-steel type		Chemical composition (%)			
AISI grade	N. Europe	Carbon	Chromium	Nickel	Molybdenum
304L	1.4307	< 0.03	17 - 19	8 - 10	0
316L	1.4404	< 0.03	17 - 19	10 - 13	2 - 2.25

AISI 304L stainless-steel

The most commonly used type in the food and beverage industry because of its resistance to corrosion and ease of cleaning.

- Prevention against corrosion, especially in the presence of organic acids.
- Resistance to the effects of nitrous gas in the presence of condensed water and in most aggressive environments.



AISI 316L stainless-steel

Recommended in salty or chlorinated environments because of its very high resistance to corrosion created by molybdenum.

- Improved resistance to corrosion.
- Particularly well adapted to environments with acidity, bromine and saline halides or very corrosive additives and solvents.



The finish

The finish: Three solutions for protection against aggressive substances

Surface condition plays an important role in the fight against bacteria. The lower the roughness, the fewer bacteria become incrustated. Reduced roughness means fewer bacteria, less adhesion, and a finish that's impeccable. The choice of finish determines the appearance of the enclosures that matches the environment of other machines and equipment.



Solution 1: Scotch-Brite® brushing

The method uses brushing as defined by the ASTM (American Society for Testing and Material).

- Finish very commonly used for the chemical and food and beverage industries.
- Surface roughness is improved thanks to an additional polishing process which offers more efficient characteristics against polluting elements.
- Surface roughness: $Ra \leq 0.8 \mu m$.



Solution 2: Micro-beading (on request)

Exclusiveness, an impeccable finish with silky-smooth appearance.

The method:

- Bombardment with miniscule ceramic balls of the entire surface to be treated at very high speed.
- Closes micro-cracks caused during lamination by flattening the surface.

The result:

- Increased hardness.
- Reduced surface roughness: $Ra \approx 0.8 \mu m$.
- A perfectly even surface, with a silky appearance (no scratches and no burrs).
- Reduces the adhesion of materials.
- Allows disinfection.
- Typical application: Pharmaceutical and food and beverage industries.

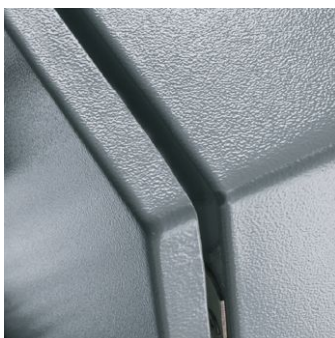

Solution 3: Protective coating (on request)

The highest protection against aggressive substances, external pollution and projections of metal particles.

- Provides ultimate protection against corrosion.
- Typical applications: Marine, seaside, off-shore.

These enclosures have been specially designed for the chemical, oil and food and beverage industries, among others, which are particularly demanding in terms of hygiene and resistance to corrosion.

5



Finishes

- Two types of steel offered as standard: 304L and 316L, with Scotch-Brite® brushed finish.
- Painted or micro-beaded finish (on request).



Robustness and durability

Resistance to external mechanical impacts:

- IK10: Plain door, IK08: Glazed door.
- Door reinforcement frame or profile.
- Stainless-steel hinges.



Large range of accessories

- Stainless-steel accessories: canopy, wall fixing lugs.
- Standard accessories: mounting plate, inner door, modular chassis and step slides.
- Large selection of locks made of 100% stainless-steel.



Time savings and convenience

- 304L or 316L stainless-steel wall fixing lugs.
- Vertical reinforcement perforated profiles, which make it easier to equip the door.
- Reversible door opening to 120°.
- Easy installation directly on the machine thanks to the 4 rear drilled holes.



Sealing



- Protection rating of IP66 (1 door) or IP55 (2 doors) according to IEC 60529: Complete protection against dust and water sprays.
- Polyurethane gasket.
- Gutter-shaped front profile.
- Three locking points for the double-door.

For details consult our web site
www.se.com

Comment:
For more information see page 157







Characteristics	NSYS3X●●●●	NSYS3X●●●●T	NSYS3X●●●●H
	304L stainless-steel Enclosure with plain door.	304L stainless-steel Enclosure with glazed door, Securit® glass, 4 (0.16) mm (in.) thick.	316L stainless-steel Enclosure with plain door.
Material	AISI 304L		AISI 316L
Finish	Scotch-Brite® brushed		
Thickness	10 (0.40)/10° - 15 (0.59)/10° mm (in.)		
Ingress protection rating	IP66 (1 door) or IP55 (2 doors) according to IEC 60529		
Mechanical protection rating	IK10 according to IEC 62262	IK08 according to IEC 62262	IK10 according to IEC 62262
Standards and certifications	See technical guide on page 506		
Installation	Outdoor installation: Compliant with IEC 62208 regarding type tests specified in §9.12 (resistance to ultra-violet (UV) radiation) and §9.13 (resistance to corrosion). It is always advisable to install a canopy to avoid water stagnation on the upper part of the enclosure		
Other characteristics	<ul style="list-style-type: none"> • Single-piece body (cross-shaped structure). Gutter-shaped front profile • 4 rear studs for fixing the material • 2 cut-out vertical profiles on the door (from a height of 600 (23.62) mm (in.)), with drill holes with a diameter of 4.25 (0.17) mm (in.) and a pitch of 25 (0.98) mm (in.) for installing accessories • Door reinforcement frame (from a height of 1000 (39.37) mm (in.)), cross-section of 20 (0.79) mm (in.) x 15 (0.59) mm (in.) with drilled holes with a diameter of 5 (0.20) mm (in.) and a pitch of 25 (0.98) mm (in.) • Standard lock with 3 (0.12) mm (in.) double-bar lock (chrome-plated zamak) • 2 locking points for heights of more than 500 (19.68) mm (in.) or three points for two-door enclosures • Stainless-steel hinges screwed to the body of the enclosure. They make it easier to remove and invert the door. Opening angle: 120° • Maximum load on the door: 50 (110.23) kg (lbs.)/m² • Polyurethane gasket • M6 x 16 (0.63) mm (in.) screws on the door and on the body, allowing equipotential connection between the earth connections (on request) • 4 holes for fixing to the wall directly or with the help of mounting lugs (on request), sealed by sealing plugs 		

					304L stainless-steel	316L stainless-steel	
External dimensions							
Height mm (in.)	Width mm (in.)	Depth mm (in.)	No. of locks	No. of doors	Plain door	Glazed door. The glazed door has no reinforcement.	Plain door
300 (11.81)	200 (7.87)	150 (5.91)	1	1	NSYS3X3215	-	NSYS3X3215H
300 (11.81)	250 (9.84)	150 (5.91)	1	1	NSYS3X302515	-	NSYS3X302515H
300 (11.81)	300 (11.81)	150 (5.91)	1	1	NSYS3X3315	-	NSYS3X3315H
400 (15.75)	300 (11.81)	150 (5.91)	1	1	NSYS3X4315	-	NSYS3X4315H
400 (15.75)	300 (11.81)	200 (7.87)	1	1	NSYS3X4320	NSYS3X4320T	NSYS3X4320H
400 (15.75)	400 (15.75)	200 (7.87)	1	1	NSYS3X4420	-	NSYS3X4420H
400 (15.75)	600 (23.62)	200 (7.87)	1	1	NSYS3X4620	-	NSYS3X4620H
500 (19.68)	400 (15.75)	200 (7.87)	2	1	NSYS3X5420	NSYS3X5420T	NSYS3X5420H
600 (23.62)	400 (15.75)	200 (7.87)	2	1	NSYS3X6420	NSYS3X6420T	NSYS3X6420H
600 (23.62)	600 (23.62)	250 (9.84)	2	1	NSYS3X6625	-	NSYS3X6625H
600 (23.62)	1000 (39.37)	300 (11.81)	-	2	NSYS3X601030	-	-
600 (23.62)	1200 (47.24)	300 (11.81)	-	2	NSYS3X601230	-	-
700 (27.56)	500 (19.68)	250 (9.84)	2	1	NSYS3X7525	NSYS3X7525T	NSYS3X7525H
800 (31.50)	600 (23.62)	250 (9.84)	2	1	NSYS3X8625	NSYS3X8625T	NSYS3X8625H
800 (31.50)	800 (31.50)	300 (11.81)	2	1	NSYS3X8830	-	NSYS3X8830H
800 (31.50)	1000 (39.37)	300 (11.81)	-	2	NSYS3X801030	-	-
800 (31.50)	1200 (47.24)	300 (11.81)	-	2	NSYS3X801230	-	-
1000 (39.37)	800 (31.50)	300 (11.81)	2	1	NSYS3X10830	NSYS3X10830T	NSYS3X10830H
1000 (39.37)	1000 (39.37)	300 (11.81)	-	2	NSYS3X101030	-	NSYS3X101030H
1200 (47.24)	800 (31.50)	300 (11.81)	2	1	NSYS3X12830	-	NSYS3X12830H
1200 (47.24)	1000 (39.37)	300 (11.81)	-	2	NSYS3X121030	-	NSYS3X121030H

⁽¹⁾ Three-point locking system.

Accessories

									
External dimensions					Mounting plate Plain	Mounting plate Silkscreened	Mounting plate Microperforated	Mounting plate Telequick	Step slides
Height mm (in.)	Width mm (in.)	Depth mm (in.)	No. of modules						
300 (11.81)	200 (7.87)	150 (5.91)	-	NSYMM32	-	NSYMF32	NSYMR32	-	
300 (11.81)	250 (9.84)	150 (5.91)	-	NSYMM3025	-	-	NSYMR3025	-	
300 (11.81)	300 (11.81)	150 (5.91)	-	NSYMM33	-	NSYMF33	NSYMR33	-	
400 (15.75)	300 (11.81)	150 (5.91)	24	NSYMM43	NSYMS43	NSYMF43	NSYMR43	-	
400 (15.75)	300 (11.81)	200 (7.87)	24	NSYMM43	NSYMS43	NSYMF43	NSYMR43	NSYSDCR200	
400 (15.75)	400 (15.75)	200 (7.87)	-	NSYMM44	NSYMS44	NSYMF44	NSYMR44	NSYSDCR200	
400 (15.75)	600 (23.62)	200 (7.87)	-	NSYMM64	NSYMS64	NSYMF64	NSYMR46	NSYSDCR200	
500 (19.68)	400 (15.75)	200 (7.87)	48	NSYMM54	NSYMS54	NSYMF54	NSYMR54	NSYSDCR200	
600 (23.62)	400 (15.75)	200 (7.87)	48	NSYMM64	NSYMS64	NSYMF64	NSYMR64	NSYSDCR200	
600 (23.62)	600 (23.62)	250 (9.84)	84	NSYMM66	NSYMS66	NSYMF66	NSYMR66	NSYSDCR250	
600 (23.62)	1000 (39.37)	300 (11.81)	-	NSYMM106	-	NSYMF106	NSYMR106	NSYSDCR300	
600 (23.62)	1200 (47.24)	300 (11.81)	-	NSYMM126	-	NSYMF126	-	NSYSDCR300	
700 (27.56)	500 (19.68)	250 (9.84)	66	NSYMM75	NSYMS75	NSYMF75	NSYMR75	NSYSDCR250	
700 (27.56)	500 (19.68)	250 (9.84)	88	-	-	-	-	-	
800 (31.50)	600 (23.62)	250 (9.84)	84	NSYMM86	NSYMS86	NSYMF86	NSYMR86	NSYSDCR250	
800 (31.50)	600 (23.62)	250 (9.84)	112	-	-	-	-	-	
800 (31.50)	800 (31.50)	300 (11.81)	-	NSYMM88	-	NSYMF88	NSYMR88	NSYSDCR300	
800 (31.50)	1000 (39.37)	300 (11.81)	-	NSYMM108	-	NSYMF108	NSYMR108	NSYSDCR300	
800 (31.50)	1200 (47.24)	300 (11.81)	-	NSYMM128	-	NSYMF128	NSYMR128	NSYSDCR300	
1000 (39.37)	800 (31.50)	300 (11.81)	234	NSYMM108	-	NSYMF108	NSYMR108	NSYSDCR300	
1000 (39.37)	1000 (39.37)	300 (11.81)	-	NSYMM1010	-	NSYMF1010	NSYMR1010	NSYSDCR300	
1200 (47.24)	800 (31.50)	300 (11.81)	-	NSYMM128	-	NSYMF128	NSYMR128	NSYSDCR300	
1200 (47.24)	1000 (39.37)	300 (11.81)	-	NSYMM1210	-	NSYMF1210	NSYMR1210	NSYSDCR300	

⁽¹⁾ Three-point locking system.

Plinth

- Material: Stainless-steel, AISI 304L or AISI 316L
- Finish: Scotch-Brite® brushing, to help guarantee the durability in applications where contact to the floor increases the risk of corrosion
- Installation: Plinth fixing kit must be ordered separately (ref. **NSYAPFXWM**) composed by fixing elements and drilling jig



NSYSFPFX8100

Characteristics	Width mm (in.)	References
Plinth height 100 (3.94) mm (in.) Kit (4 corners + front and back), AISI 304L	800 (31.50)	NSYSFPFX8100
Plinth height 100 (3.94) mm (in.) Kit (4 corners + front and back), AISI 304L	1000 (39.37)	NSYSFPFX10100
Plinth height 100 (3.94) mm (in.) Kit (4 corners + front and back), AISI 316L	800 (31.50)	NSYSFPFX8100H
Plinth height 100 (3.94) mm (in.) Kit (4 corners + front and back), AISI 316L	1000 (39.37)	NSYSFPFX10100H



NSYSFPSX3100

Characteristics	Depth mm (in.)	References
Plinth height 100 (3.94) mm (in.) Set of 2 side panels, AISI 304L	300 (11.81)	NSYSFPSX3100
Plinth height 100 (3.94) mm (in.) Set of 2 side panels, AISI 316L	300 (11.81)	NSYSFPSX3100H



NSYSFPFX8200

Characteristics	Width mm (in.)	References
Plinth height 200 (7.87) mm (in.) Kit (4 corners + front and back), AISI 304L	800 (31.50)	NSYSFPFX8200
Plinth height 200 (7.87) mm (in.) Kit (4 corners + front and back), AISI 304L	1000 (39.37)	NSYSFPFX10200
Plinth height 200 (7.87) mm (in.) Kit (4 corners + front and back), AISI 316L	800 (31.50)	NSYSFPFX8200H
Plinth height 200 (7.87) mm (in.) Kit (4 corners + front and back), AISI 316L	1000 (39.37)	NSYSFPFX10200H



NSYSFPSX3200

Characteristics	Depth mm (in.)	References
Plinth height 200 (7.87) mm (in.), Set of 2 side panels (x2), AISI 304L	300 (11.81)	NSYSFPSX3200
Plinth height 200 (7.87) mm (in.), Set of 2 side panels (x2), AISI 316L	300 (11.81)	NSYSFPSX3200H

Plain mounting plate screw



NSYS13M5HS



Characteristics	Supply mm (in.)	References
Plain mounting plate screw, Self-tapping screw M5 x 13 (0.51) mm (in.)	100 (3.94)	NSYS13M5HS
Plain mounting plate screw, Self-tapping screw M5 x 16 (0.63) mm (in.)	100 (3.94)	NSYS16M5HS
Plain mounting plate screw, Self-tapping screw M6 x 16 (0.63) mm (in.)	100 (3.94)	NSYS16M6HS

Accessories

Clip-on nuts: [page 270](#)
 Reference: **AF1EA6**
 Cable entries: [page 272](#)
 Reference: **NSYSAM504SE**

Stainless-steel cable gland with lamellar insert: [page 274](#)
 Reference: **NSYCGX12**
 Lighting: [page 294](#)
 Reference: **NSYLMLDS**

Adhesive plastic document pocket: [page 298](#)
 Reference: **NSYDPA44**
 Door switch: [page 298](#)
 Reference: **NSYINLCRN**

Canopy

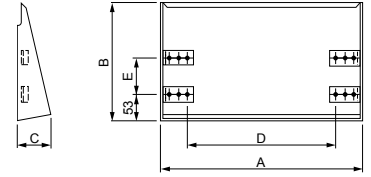

- Material: 304L stainless-steel sheet
- Finish: Scotch-Brite® brushed
- Thickness: 15 (5.91)/10* mm (in.)
- Installation: Direct fixing to the body of the enclosure

Supply:
Delivered with the fixings required for installation



Characteristics	Width mm (in.)	Depth mm (in.)	Dimensions					References
			A mm (in.)	B mm (in.)	C mm (in.)	D mm (in.)	E mm (in.)	
Canopy	200 (7.87)	150 (5.91)	205 (8.07)	183 (7.20)	51 (2.01)	120 (4.72)	-	NSYTX2015
Canopy	250 (9.84)	150 (5.91)	205 (8.07)	183 (7.20)	51 (2.01)	120 (4.72)	-	NSYTX2515
Canopy	300 (11.81)	150 (5.91)	305 (12.01)	183 (7.20)	51 (2.01)	220 (8.66)	-	NSYTX3015
Canopy	300 (11.81)	200 (7.87)	305 (12.01)	233 (9.17)	51 (2.01)	220 (8.66)	70 (2.76)	NSYTX3020
Canopy	400 (15.75)	200 (7.87)	405 (15.94)	233 (9.17)	70 (2.76)	320 (12.60)	70 (2.76)	NSYTX4020
Canopy	600 (23.62)	200 (7.87)	605 (23.82)	233 (9.17)	70 (2.76)	520 (20.47)	70 (2.76)	NSYTX6020
Canopy	600 (23.62)	250 (9.84)	605 (23.82)	283 (11.14)	70 (2.76)	520 (20.47)	120 (4.72)	NSYTX6025
Canopy	1000 (39.37)	300 (11.81)	1005 (39.57)	333 (13.11)	70 (2.76)	920 (36.22)	170 (6.69)	NSYTX10030
Canopy	1200 (47.24)	300 (11.81)	1205 (47.44)	333 (13.11)	70 (2.76)	1120 (44.09)	120 (4.72)	NSYTX12030
Canopy	500 (19.68)	250 (9.84)	505 (19.88)	283 (11.14)	70 (2.76)	420 (16.54)	120 (4.72)	NSYTX5025
Canopy	800 (31.50)	300 (11.81)	805 (31.69)	333 (13.11)	70 (2.76)	720 (28.35)	170 (6.69)	NSYTX8030

5

Wall fixing lugs

- A: Enclosure height
- B: Enclosure width

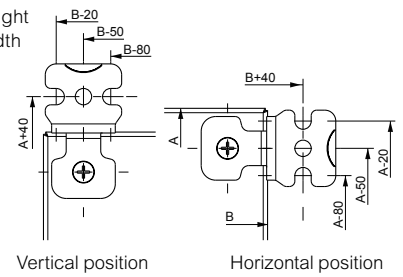

Installation:

Mounting of the wall fixing lugs in horizontal or vertical position. Fixing from the outside.

- Wall-enclosure separation of 12 (0.47) mm (in.)
- Maximum load: 250 (551.16) kg (lbs.)

Supply:
Set of four wall fixing lugs



Characteristics	References
Wall fixing-lug, 304L stainless-steel	NSYPFCX
Wall fixing-lug, 316L stainless-steel	NSYPFC2X

Support bracket for enclosure with anti-tilt kit and reinforcement

- The support bracket is used when the enclosure cannot be hung from a wall or a post.
- Maximum enclosure dimensions: 1000 (39.37) x 800 (31.50) x 300 (11.81) mm (in.).
- Floor attachment by standard M12 fastenings.
- Material: Steel
- Finish: Epoxy polyester paint
- Color: RAL 7035 grey
- Maximum load: 120 (264.55) kg (lbs.)



Characteristics	Height mm (in.)	References
Support bracket for enclosure with anti-tilt kit and reinforcement	1400 (55.12)	NSYCOENS1400
Support bracket for enclosure with anti-tilt kit and reinforcement	1800 (70.87)	NSYCOENS1800

1-point-lock options

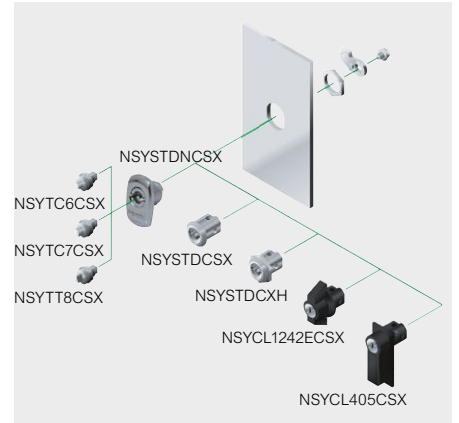

- Protection rating: IP66
- For locks for double-door enclosures please contact us.

Characteristics	Type	Material	References
Double-bar lock	Escutcheon with insert, 3 (0.12) mm (in.)	Chrome-plated zamak	NSYSTDNC SX
Insert	triangular, 8 (0.32) mm (in.)	304L stainless-steel	NSYTT8CSX
Insert	square, 7 (0.28) mm (in.)	304L stainless-steel	NSYTC7CSX
Insert	square, 6 (0.24) mm (in.)	304L stainless-steel	NSYTC6CSX
Round lock	round, 3 (0.12) mm (in.) (spare)	Chromeplated zamak	NSYSTDCSX
Round lock	round, 3 (0.12) mm (in.)	304L stainless-steel	NSYSTDCXH
Round lock	round	316 stainless-steel, please contact us for availability	NSYSTDCX2H
Handle lock	Padlock	316 stainless-steel, please contact us for availability	NSYCBXHCRN
Handle lock	1242E	Chrome-plated zamak	NSYCL1242ECSX
Handle lock	405	Polyamide	NSYCL405CSX
Handle lock	610	Polyamide	NSYCL610CSX

5

3-point-lock options

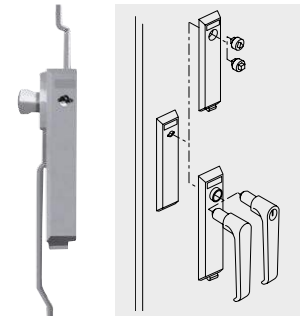

- Protection rating: IP66

Type	Material	References
Handle lock	100% stainless-steel	NSYTSML

Wall-mounted door retainer, steel

To block the door in the open position.

- It is installed on enclosures with heights from 400 (15.75) mm (in.) and widths from 300 (11.81) mm (in.).
- Door opening angle: 120°.
- Earthing connection of the enclosure by means of the reinforcement rail.
- Earthing accessories supplied with the enclosure (earth-connection cable to be ordered separately), see [page 303](#).
- Material: Steel

Comment:
It is not compatible with installing the 19" swing rack and the internal door.



Characteristics	References
Wall-mounted door retainer, steel	NSYAEDRSCST

Eyebolts, Consult us for availability

- Material: Stainless-steel 304L
- Maximum load: 210 (462.97) kg (lbs.) per enclosure when slinging at 60°
- Supply reinforcing brackets attached to therings (these brackets also act as a drilling template)



NSYAELYTCRXG8

Characteristics	References
Set of 2 M8 eyebolts	NSYAELYTCRXG8

Inner door

- 3 (0.12) mm (in.) double-bar lock.
- Not compatible with door retainer and door switch. Consult us.
- Maximum load: 30 (66.14) kg (lbs.)/m²

Installation: As standard it can be mounted an inner door and a mounting plate, on the step slides, at the same time

- Can be mounted either on the front side of the enclosure or on step slides (not supplied with standard)

Supply:
1 inner door



NSYPIN43

Characteristics	Height mm (in.)	Width mm (in.)	D mm (in.)	E mm (in.)	G mm (in.)	H mm (in.)	I min. mm (in.)	References
Inner door for wall-mounted enclosures	400 (15.75)	300 (11.81)	349 (13.74)	241 (9.49)	208 (8.19)	32 (1.26)	51 (2.01)	NSYPIN43
Inner door for wall-mounted enclosures	500 (19.68)	400 (15.75)	449 (17.68)	341 (13.42)	308 (12.13)	32 (1.26)	51 (2.01)	NSYPIN54
Inner door for wall-mounted enclosures	600 (23.62)	400 (15.75)	549 (21.61)	341 (13.42)	308 (12.13)	32 (1.26)	51 (2.01)	NSYPIN64
Inner door for wall-mounted enclosures	700 (27.56)	500 (19.68)	649 (25.55)	441 (17.36)	408 (16.06)	32 (1.26)	51 (2.01)	NSYPIN75
Inner door for wall-mounted enclosures	800 (31.50)	600 (23.62)	749 (29.49)	541 (21.30)	508 (20.00)	32 (1.26)	51 (2.01)	NSYPIN86
Inner door for wall-mounted enclosures	1000 (39.37)	800 (31.50)	949 (37.36)	741 (29.17)	708 (27.87)	32 (1.26)	51 (2.01)	NSYPIN108
Inner door for wall-mounted enclosures	1200 (47.24)	800 (31.50)	1149 (45.24)	741 (29.17)	708 (27.87)	32 (1.26)	52 (2.05)	NSYPIN128

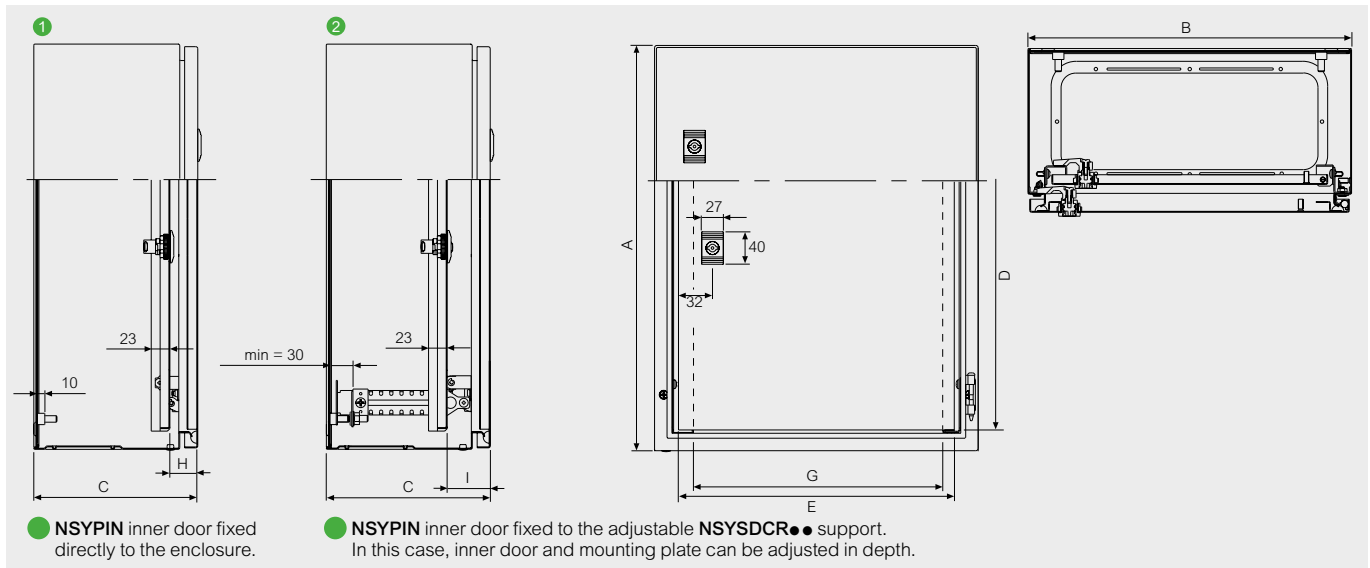

Height mm (in.)	Width mm (in.)	D mm (in.)	E mm (in.)	G mm (in.)	H mm (in.)	I min. mm (in.)	References
400 (15.75)	300 (11.81)	349 (13.74)	241 (9.49)	208 (8.19)	32 (1.26)	51 (2.01)	NSYPIN43
500 (19.68)	400 (15.75)	449 (17.68)	341 (13.42)	308 (12.13)	32 (1.26)	51 (2.01)	NSYPIN54
600 (23.62)	400 (15.75)	549 (21.61)	341 (13.42)	308 (12.13)	32 (1.26)	51 (2.01)	NSYPIN64
700 (27.56)	500 (19.68)	649 (25.55)	441 (17.36)	408 (16.06)	32 (1.26)	51 (2.01)	NSYPIN75
800 (31.50)	600 (23.62)	749 (29.49)	541 (21.30)	508 (20.00)	32 (1.26)	51 (2.01)	NSYPIN86
1000 (39.37)	800 (31.50)	949 (37.36)	741 (29.17)	708 (27.87)	32 (1.26)	51 (2.01)	NSYPIN108
1200 (47.24)	800 (31.50)	1149 (45.24)	741 (29.17)	708 (27.87)	32 (1.26)	52 (2.05)	NSYPIN128

Fig. 1

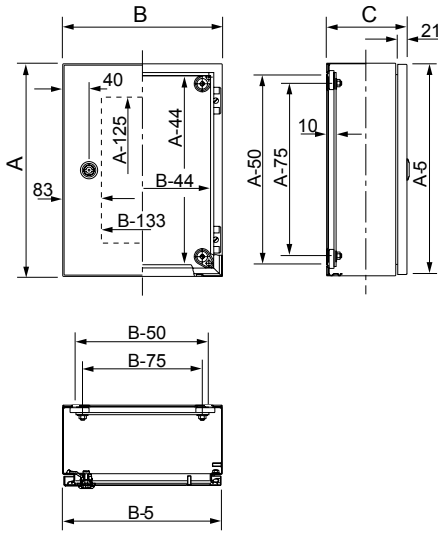
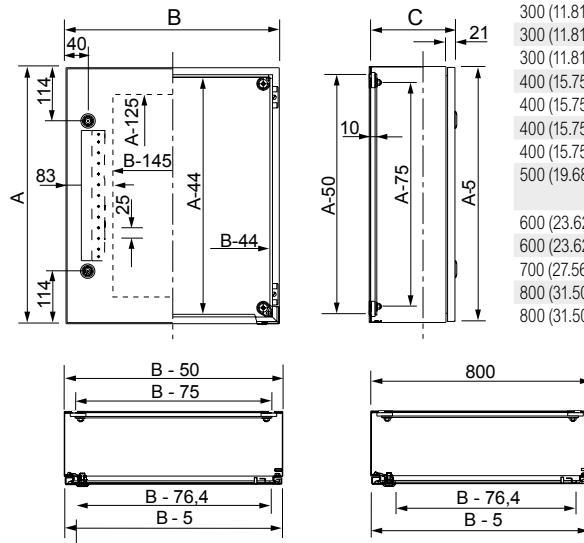

Fig. 2



External dimensions mm (in.)			Fig.
A	B	C	
300 (11.81)	200 (7.87)	150 (5.91)	1
300 (11.81)	250 (9.84)	150 (5.91)	1
300 (11.81)	300 (11.81)	150 (5.91)	1
400 (15.75)	300 (11.81)	150 (5.91)	1
400 (15.75)	300 (11.81)	200 (7.87)	1
400 (15.75)	400 (15.75)	200 (7.87)	1
400 (15.75)	600 (23.62)	200 (7.87)	1
500 (19.68)	400 (15.75)	200 (7.87)	2 Without door reinforcement
600 (23.62)	400 (15.75)	200 (7.87)	2
600 (23.62)	600 (23.62)	250 (9.84)	2
700 (27.56)	500 (19.68)	250 (9.84)	2
800 (31.50)	600 (23.62)	250 (9.84)	2
800 (31.50)	800 (31.50)	300 (11.81)	2

Fig. 3

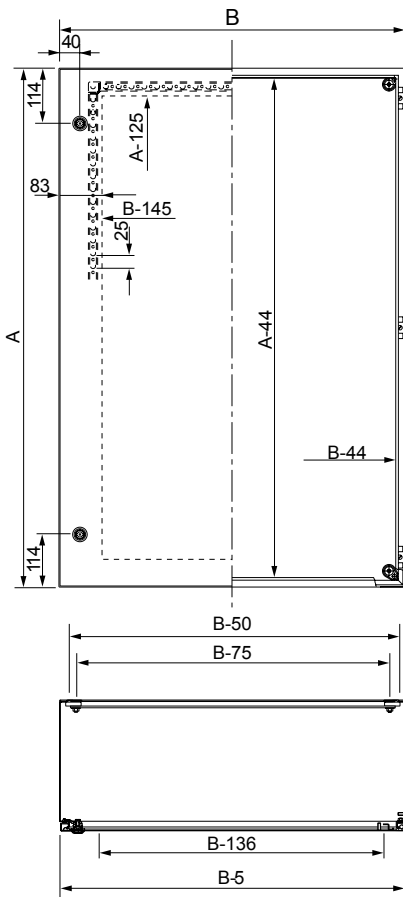
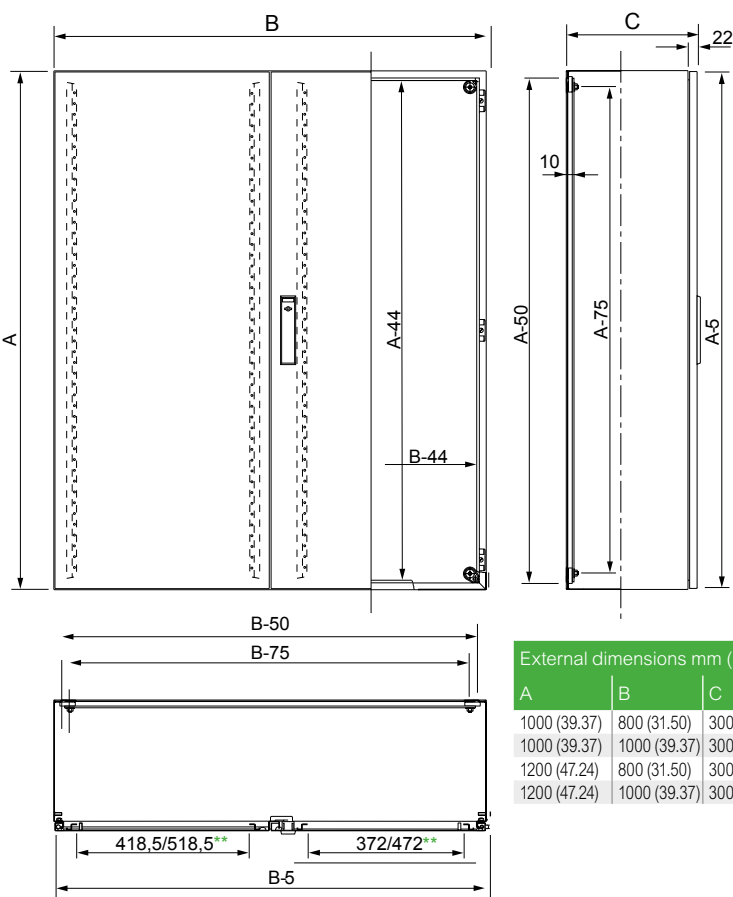

Fig. 4



External dimensions mm (in.)			Fig.
A	B	C	
1000 (39.37)	800 (31.50)	300 (11.81)	3
1000 (39.37)	1000 (39.37)	300 (11.81)	4
1200 (47.24)	800 (31.50)	300 (11.81)	3
1200 (47.24)	1000 (39.37)	300 (11.81)	4

** For glazed door.

Stainless-Steel Floor-Standing Enclosures

Spacial SMX



Spacial SFX



6

Spacial SMX SFX

Introduction	160
Characteristics	161
Accessories	162
Dimensions	166

These enclosures have been specially designed for the chemical, oil and food and beverage industries, among others, which are particularly demanding in terms of hygiene and resistance to corrosion.

6



Material and finishes

- AISI 304L as standard in Spacial SMX and SFX.
- AISI 316L as standard in Spacial SMX and on request in Spacial SFX.
- Finishes:
 - Scotch-Brite® brushed (standard).
 - Micro-beaded (on request).
 - Painted (on request).

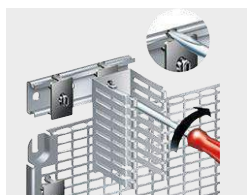

Time savings and convenience

- Complete range of accessories for installation, cable management, etc.
- 316L stainless-steel plinth: easy cable entry.
- 304L or 316L stainless-steel plinth: easy cable entry (Spacial SFX and SMX).
- Reversible door opening to 120°.
- Padlock lock with key or form insert.
- Adjustment rails perforated with a pitch of 25 (0.98) mm (in.)
- Perforated reinforcement frame allowing accessories to be mounted on the door.



Sealing

- Protection rating against dust and water IP66 or IP55 depending on model according to IEC 60529.
- 3-point locking systems.
- Canopy (optional):
 - Protects the door sealing,
 - Helps guarantee correct water drainage,
 - No stagnation on the top.
- Single-piece cable gland plate with polyurethane gasket.



Compatible with the other ranges

- The mounting plates and other accessories of the Spacial SM and SF can be combined with metal products.



Hygiene

- The high quality of the standard finish enables very easy maintenance while avoiding contamination.
- The hygienic feet made from 316L stainless-steel, adjustable between 140 (5.51) mm (in.) and 200 (7.87) mm (in.) in height, make it easier to clean under the enclosures.



Robustness and durability

- Resistance to external mechanical impacts: IK10 according to IEC 62262.
- 3 hinges made entirely from stainless-steel.
- Door reinforcement frame.



Resistance to corrosion

- High resistance to corrosion. 304L and 316L stainless-steels provide the best solutions for applications in extremely demanding environments.

For details consult our web site www.se.com



SMX



SFX

Characteristics	Spacial SMX	Spacial SFX
	<ul style="list-style-type: none"> Stainless-steel floor-standing enclosure, folded and welded. Single and double front door, with reinforcement frame. 	<ul style="list-style-type: none"> Enclosure made up of a structure, consisting of top and bottom, rear panel and vertical profiles. Single and double front door, with reinforcement frame.
Material	304L stainless-steel, 316L stainless-steel	304L stainless-steel, 316L version (on request)
Finish	Scotch-Brite® brushed finish Micro-beaded and painted finishes (on request)	
Thickness	15 (0.59)/10° mm (in.)	Consult us
Ingress protection rating	IP66 according to IEC 62208 (single-door enclosure)	
Mechanical protection rating	IK10 according to IEC 62262	
Standards and certifications	See technical guides page 506	
Installation	Outdoor installation: Compliant with IEC 62208 regarding type tests specified in §9.12 (resistance to ultra-violet (UV) radiation) and §9.13 (resistance to corrosion). Comment: SMX and SFX units do not require a canopy for outdoor use.	
Other characteristics	<ul style="list-style-type: none"> Plain front door. Opening to left or right to 120° with reinforcement frame installed: 3 stainless-steel hinges 3-point locking system with handle made from painted zamak, 5 (0.20) mm (in.) double-bar Acceptable load of 50 (110.23) kg (lbs.) 	
Supply	<ul style="list-style-type: none"> Welded compact body Single-piece cable gland plate with sealing gasket Welded mounting plate support brackets 	<ul style="list-style-type: none"> Welded rear panel 4 mounting plate-supporting brackets Single-piece cable gland plate with sealing gasket

6

Comment:
Dimensions,
see [page 166](#)

304L	316L	304L
------	------	------



SMX



SMX



SFX

External dimensions				304L	316L	304L
Height mm (in.)	Width mm (in.)	Depth mm (in.)	Number of front doors	Stainless-steel enclosure	Stainless-steel enclosure	Stainless-steel suitable enclosure
1400 (55.12)	1000 (39.37)	300 (11.81)	2	NSYSMX141030	–	–
1600 (62.99)	800 (31.50)	400 (15.75)	1	NSYSMX16840	–	–
1800 (70.87)	600 (23.62)	400 (15.75)	1	NSYSMX18640	–	NSYSFX18640
1800 (70.87)	800 (31.50)	400 (15.75)	1	NSYSMX18840	NSYSMX18840H	NSYSFX18840
1800 (70.87)	1200 (47.24)	400 (15.75)	2	NSYSMX181240	NSYSMX181240H	NSYSFX181240
1800 (70.87)	1600 (62.99)	400 (15.75)	2	NSYSMX181640	NSYSMX181640H	–
2000 (78.74)	600 (23.62)	500 (19.68)	1	–	–	NSYSFX20650
2000 (78.74)	800 (31.50)	400 (15.75)	1	–	–	NSYSFX20840
2000 (78.74)	800 (31.50)	500 (19.68)	1	NSYSMX20850	–	–
2000 (78.74)	800 (31.50)	600 (23.62)	1	–	–	NSYSFX20860
2000 (78.74)	1000 (39.37)	400 (15.75)	2	NSYSMX201040	NSYSMX201040H	–
2000 (78.74)	1000 (39.37)	600 (23.62)	2	–	–	NSYSFX201060
2000 (78.74)	1200 (47.24)	500 (19.68)	2	NSYSMX201250	NSYSMX201250H	–
2000 (78.74)	1200 (47.24)	600 (23.62)	2	–	–	NSYSFX201260
2000 (78.74)	1600 (62.99)	600 (23.62)	2	NSYSMX201660	NSYSMX201660H	–

Technical changes reserved. Information provided without guarantee. Images are for illustrative purposes only.

Stainless-Steel Floor-Standing Enclosures

Spacial SMX - SFX, Accessories

SMX



Plinth height 100 (3.94) mm (in.)
(4 corners + front and back)



Plinth height 100 (3.94) mm (in.)
(Set of 2 side panels)



Plinth height 200 (7.87) mm (in.)
(4 corners + front and back)



Plinth height 200 (7.87) mm (in.)
(Set of 2 side panels)

Characteristics			Stainless-steel plinths							
Material			Stainless-steel, AISI 304L				Stainless-steel, AISI 316L			
Finish			Scotch-Brite®-brushing to ensure durability in applications where contact with the floor increases the risk of corrosion							
External dimensions mm (in.)			Plinth height 100 (3.94) mm (in.)		Plinth height 200 (7.87) mm (in.)		Plinth height 100 (3.94) mm (in.)		Plinth height 200 (7.87) mm (in.)	
Height (A)	Width (B)	Depth (C)	Kit (4 corners + front and back)	Set of 2 side panels	Kit (4 corners + front and back)	Set of 2 side panels (x2)	Kit (4 corners + front and back)	Set of 2 side panels	Kit (4 corners + front and back)	Set of 2 side panels (x2)
1400 (55.12)	1000 (39.37)	300 (11.81)	NSYSPFX10100	NSYSPSX3100	NSYSPFX10200	NSYSPSX3200	NSYSPFX10100H	NSYSPSX3100H	NSYSPFX10200H	NSYSPSX3200H
1600 (62.99)	800 (31.50)	400 (15.75)	NSYSPFX8100	NSYSPSX4100	NSYSPFX8200	NSYSPSX4200	NSYSPFX8100H	NSYSPSX4100H	NSYSPFX8200H	NSYSPSX4200H
1800 (70.87)	600 (23.62)	400 (15.75)	NSYSPFX6100	NSYSPSX4100	NSYSPFX6200	NSYSPSX4200	NSYSPFX6100H	NSYSPSX4100H	NSYSPFX6200H	NSYSPSX4200H
	800 (31.50)	400 (15.75)	NSYSPFX8100	NSYSPSX4100	NSYSPFX8200	NSYSPSX4200	NSYSPFX8100H	NSYSPSX4100H	NSYSPFX8200H	NSYSPSX4200H
	1200 (47.24)	400 (15.75)	NSYSPFX12100	NSYSPSX4100	NSYSPFX12200	NSYSPSX4200	NSYSPFX12100H	NSYSPSX4100H	NSYSPFX12200H	NSYSPSX4200H
	1600 (62.99)	400 (15.75)	NSYSPFX16100	NSYSPSX4100	NSYSPFX16200	NSYSPSX4200	NSYSPFX16100H	NSYSPSX4100H	NSYSPFX16200H	NSYSPSX4200H
2000 (78.74)	600 (23.62)	500 (19.68)	NSYSPFX6100	NSYSPSX5100	NSYSPFX6200	NSYSPSX5200	NSYSPFX6100H	NSYSPSX5100H	NSYSPFX6200H	NSYSPSX5200H
	800 (31.50)	400 (15.75)	NSYSPFX8100	NSYSPSX4100	NSYSPFX8200	NSYSPSX4200	NSYSPFX8100H	NSYSPSX4100H	NSYSPFX8200H	NSYSPSX4200H
	800 (31.50)	500 (19.68)	NSYSPFX8100	NSYSPSX5100	NSYSPFX8200	NSYSPSX5200	NSYSPFX8100H	NSYSPSX5100H	NSYSPFX8200H	NSYSPSX5200H
	800 (31.50)	600 (23.62)	NSYSPFX8100	NSYSPSX6100	NSYSPFX8200	NSYSPSX6200	NSYSPFX8100H	NSYSPSX6100H	NSYSPFX8200H	NSYSPSX6200H
	1000 (39.37)	400 (15.75)	NSYSPFX10100	NSYSPSX4100	NSYSPFX10200	NSYSPSX4200	NSYSPFX10100H	NSYSPSX4100H	NSYSPFX10200H	NSYSPSX4200H
	1000 (39.37)	600 (23.62)	NSYSPFX10100	NSYSPSX6100	NSYSPFX10200	NSYSPSX6200	NSYSPFX10100H	NSYSPSX6100H	NSYSPFX10200H	NSYSPSX6200H
	1200 (47.24)	500 (19.68)	NSYSPFX12100	NSYSPSX5100	NSYSPFX12200	NSYSPSX5200	NSYSPFX12100H	NSYSPSX5100H	NSYSPFX12200H	NSYSPSX5200H
	1200 (47.24)	600 (23.62)	NSYSPFX12100	NSYSPSX6100	NSYSPFX12200	NSYSPSX6200	NSYSPFX12100H	NSYSPSX6100H	NSYSPFX12200H	NSYSPSX6200H
1600 (62.99)	600 (23.62)	NSYSPFX16100	NSYSPSX6100	NSYSPFX16200	NSYSPSX6200	NSYSPFX16100H	NSYSPSX6100H	NSYSPFX16200H	NSYSPSX6200H	

SFX



Plinth height 100 (3.94) mm (in.)
(4 corners + front and back)



Plinth height 100 (3.94) mm (in.)
(Set of 2 side panels)

Characteristics			Stainless-steel plinths			
Material			Stainless-steel, AISI 304L			
Finish			Scotch-Brite®-brushing to ensure durability in applications where contact with the floor increases the risk of corrosion			
Installation			Mounting in the holes for fixing the enclosures to the floor. Suitable for steel floor-standing enclosures (SF and SM)			
External dimensions mm (in.)			Plinth height 100 (3.94) mm (in.)		Plinth height 200 (7.87) mm (in.)	
Height (A)	Width (B)	Depth (C)	Kit (4 corners + front and back)	Set of 2 side panels	Kit (4 corners + front and back)	Set of 2 side panels (x2)
1400 (55.12)	1000 (39.37)	300 (11.81)	NSYSPFX10100	-	NSYSPFX10200	-
1600 (62.99)	800 (31.50)	400 (15.75)	NSYSPFX8100	NSYSPSX4100SF	NSYSPFX8200	NSYSPSX4200SF
1800 (70.87)	600 (23.62)	400 (15.75)	NSYSPFX6100	NSYSPSX4100SF	NSYSPFX6200	NSYSPSX4200SF
	800 (31.50)	400 (15.75)	NSYSPFX8100	NSYSPSX4100SF	NSYSPFX8200	NSYSPSX4200SF
	1200 (47.24)	400 (15.75)	NSYSPFX12100	NSYSPSX4100SF	NSYSPFX12200	NSYSPSX4200SF
	1600 (62.99)	400 (15.75)	-	NSYSPSX4100SF	-	NSYSPSX4200SF
2000 (78.74)	600 (23.62)	500 (19.68)	NSYSPFX6100	NSYSPSX5100SF	NSYSPFX6200	NSYSPSX5200SF
	800 (31.50)	400 (15.75)	NSYSPFX8100	NSYSPSX4100SF	NSYSPFX8200	NSYSPSX4200SF
	800 (31.50)	500 (19.68)	NSYSPFX8100	NSYSPSX5100SF	NSYSPFX8200	NSYSPSX5200SF
	800 (31.50)	600 (23.62)	NSYSPFX8100	NSYSPSX6100SF	NSYSPFX8200	NSYSPSX6200SF
	1000 (39.37)	400 (15.75)	NSYSPFX10100	NSYSPSX4100SF	NSYSPFX10200	NSYSPSX4200SF
	1000 (39.37)	600 (23.62)	NSYSPFX10100	NSYSPSX6100SF	NSYSPFX10200	NSYSPSX6200SF
	1200 (47.24)	500 (19.68)	NSYSPFX12100	NSYSPSX5100SF	NSYSPFX12200	NSYSPSX5200SF
	1200 (47.24)	600 (23.62)	NSYSPFX12100	NSYSPSX6100SF	NSYSPFX12200	NSYSPSX6200SF
1600 (62.99)	600 (23.62)	-	NSYSPSX6100SF	-	NSYSPSX6200SF	

Comment:

Ventilated plinths made of stainless-steel for heavy-duty outdoor enclosures (page 331) are compatible to Spacial SMX stainless-steel compact enclosures.

SMX Canopy



NSYSCTX10030

- Helps guarantee very high protection of the enclosure when used outdoors.
- Material: 304L stainless-steel sheet
Other types of stainless-steel, contact us
- Finish: Scotch-Brite® brushed
- Other finishes, contact us
- Thickness 15 (0.59)/10* mm (in.)
- Installation: It is fixed in the same holes as the eyebolt.

Supply:

Delivered with fixings. Other dimensions and canopy for sets, contact us

Characteristics	Width mm (in.)	Depth mm (in.)	References
Top-mounted	600 (23.62)	400 (15.75)	NSYSCTX6040
Top-mounted	800 (31.50)	400 (15.75)	NSYSCTX8040
Top-mounted	800 (31.50)	500 (19.68)	NSYSCTX8050
Top-mounted	1000 (39.37)	300 (11.81)	NSYSCTX10030
Top-mounted	1000 (39.37)	400 (15.75)	NSYSCTX10040
Top-mounted	1200 (47.24)	400 (15.75)	NSYSCTX12040
Top-mounted	1200 (47.24)	500 (19.68)	NSYSCTX12050
Top-mounted	1600 (62.99)	400 (15.75)	NSYSCTX16040
Top-mounted	1600 (62.99)	600 (23.62)	NSYSCTX16060

SFX Canopy



NSYSCTX6040

Characteristics	Width mm (in.)	Depth mm (in.)	References
Top-mounted	600 (23.62)	400 (15.75)	NSYSCTX6040
Top-mounted	600 (23.62)	500 (19.68)	NSYSCTX6050
Top-mounted	800 (31.50)	400 (15.75)	NSYSCTX8040
Top-mounted	800 (31.50)	600 (23.62)	NSYSCTX8060
Top-mounted	1000 (39.37)	600 (23.62)	NSYSCTX10060
Top-mounted	1200 (47.24)	400 (15.75)	NSYSCTX12040
Top-mounted	1200 (47.24)	600 (23.62)	NSYSCTX12060
Top-mounted (used when coupling 2 SFX together)	1200 (47.24)	500 (19.68)	NSYSCTX12050
Top-mounted (used when coupling 2 SFX together)	1600 (62.99)	400 (15.75)	NSYSCTX16040
Top-mounted (used when coupling 2 SFX together)	1600 (62.99)	600 (23.62)	NSYSCTX16060

Supply:

Delivered with fixings. Other dimensions and canopy for sets, contact us

Locking options



NSYTDB5ME



NSYTDB5ME



NSYBCME

- The enclosures Spacial SMX and SFX are delivered as standard with a retractable handle made from
- Painted zamak with 5 (0.20) mm (in.) double-bar insert, ref. **NSYMCSX**
- Standard inserts can be replaced by shaped inserts or barrels according the following table:

Door switch for Spacial SF and SFX: page 298

Reference: **NSYDCM20**

Door switch for Spacial SM: page 298

Reference: **NSYDPCM20**

Characteristics	Type	Supply	References
Shape insert	5 (0.20) mm (in.) doublebar insert.	Insert with key	NSYTDB5ME
Shape insert	Square insert, 6 (0.24) mm (in.)	Insert with key	NSYTC6ME
Shape insert	Square insert, 8 (0.32) mm (in.)	Insert with key	NSYTC8ME
Shape insert	Triangular insert, 6.5 (0.26) mm (in.)	1 pack	NSYTT6ME
Shape insert	Triangular insert, 8 (0.32) mm (in.)	1 pack	NSYTT8ME
Padlocking system	Padlocking device	1 pack	NSYBCME
Barrels	Reinforced key and barrel	1 pack	NSYTLRME
Barrels	JIS key and barrel	1 pack	NSYTLJISME
Barrels	Manual	1 pack	NSYTMME
Barrels	Barrel and key 405E	Barrels with 1 key	NSYTCL405ME
Barrels	Barrel and key 610E	Barrels with 1 key	NSYTCL610ME
Barrels	Barrel and key 1242E	Barrels with 1 key	NSYTCL1242EME

SFX Side panels



NSY2SPX184

- Side panels including a polyurethane sealing gasket.
- Their special design helps guarantee the protection of the door gasket
- 304L stainless-steel sheet

Characteristics	Height mm (in.)	Depth mm (in.)	References
Set of 2 side panels	1800 (70.87)	400 (15.75)	NSY2SPX184
Set of 2 side panels	2000 (78.74)	400 (15.75)	NSY2SPX204
Set of 2 side panels	2000 (78.74)	500 (19.68)	NSY2SPX205
Set of 2 side panels	2000 (78.74)	600 (23.62)	NSY2SPX206

SMX Plain mounting plate



NSYMP1410

Characteristics	Height mm (in.)	Width mm (in.)	References
Plain mounting plate	1400 (55.12)	1000 (39.37)	NSYMP1410
Plain mounting plate	1600 (62.99)	800 (31.50)	NSYMP168
Plain mounting plate	1800 (70.87)	600 (23.62)	NSYMP186
Plain mounting plate	1800 (70.87)	800 (31.50)	NSYMP188
Plain mounting plate	1800 (70.87)	1200 (47.24)	NSYMP1812
Plain mounting plate	1800 (70.87)	1600 (62.99)	NSYMP1816
Plain mounting plate	2000 (78.74)	800 (31.50)	NSYMP208
Plain mounting plate	2000 (78.74)	1000 (39.37)	NSYMP2010
Plain mounting plate	2000 (78.74)	1200 (47.24)	NSYMP2012
Plain mounting plate	2000 (78.74)	1600 (62.99)	NSYMP2016

6

SFX Plain mounting plate



NSYMP186

Characteristics	Height mm (in.)	Width mm (in.)	References
Plain mounting plate	1800 (70.87)	600 (23.62)	NSYMP186
Plain mounting plate	1800 (70.87)	800 (31.50)	NSYMP188
Plain mounting plate	1800 (70.87)	1200 (47.24)	NSYMP1812
Plain mounting plate	2000 (78.74)	600 (23.62)	NSYMP206
Plain mounting plate	2000 (78.74)	800 (31.50)	NSYMP208
Plain mounting plate	2000 (78.74)	1000 (39.37)	NSYMP2010
Plain mounting plate	2000 (78.74)	1200 (47.24)	NSYMP2012

SMX SFX Uprights vertical

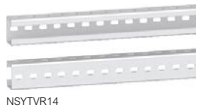

Characteristics	Height mm (in.)	References
Uprights vertical, Standard	1800 (70.87)	NSYVR18
Uprights vertical, Standard	2000 (78.74)	NSYVR20
Uprights vertical, Technical	1400 (55.12)	NSYTVR14
Uprights vertical, Technical	1600 (62.99)	NSYTVR16
Uprights vertical, Technical	1800 (70.87)	NSYTVR18
Uprights vertical, Technical	2000 (78.74)	NSYTVR20

Eyebolts



- Material: Stainless-steel 304L
- Installation: By the fixing nuts supplied
- Maximum load: 340 (749.57) kg (lbs.) for 1 eyebolt in vertical direction

Supply:
Set of four M12 eyebolts

Characteristics	References
Eyebolt	NSYSMXEB

SFX Lifting bracket



- Material: Treated steel
- Installation: They are fixed instead of the eyebolts on two suitable enclosures side-by-side, helping guarantee the rigidity of the enclosure when lifted
- Maximum load: 1300 (2866.01) kg (lbs.) when slinging at 60°

Supply:
Set of four lifting brackets

Characteristics	References
Lifting bracket for SFX	NSYPUNX

SMX Wall fixing lugs



- Material: Stainless-steel 304L
- Installation: Mounting of the wall fixing lugs in horizontal or vertical position; Fixing from the outside

Supply:
Set of four wall fixing lugs

Characteristics	References
Wall fixing lugs for SMX	NSYFCMX

Hygienic feet



- Recommended for applications that require special hygiene conditions.
- Material: 316L stainless-steel
- Installation: Adjustable between 140 (5.51) mm (in.) and 200 (7.87) mm (in.) in height
- Maximum load: 200 (440.93) kg (lbs.) per foot.

Supply:
Set of 4 adjustable feet

Characteristics	References
Hygienic feet	NSYPHX200

SFX Coupling kit

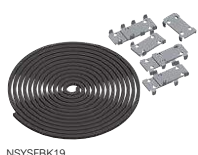

- Used for joining enclosures side by side.
- Material: Flat connectors and brackets: Zinc-coated steel (**NSYSFBK19**); Sealing gasket: EPDM (**NSYSFXJG**)
- Ingress protection rating: IP55
- Installation: Fixing from the inside of the enclosures

Characteristics	References
Coupling kit for SFX	NSYSFBK19
Coupling kit for SFX	NSYSFXJG

6

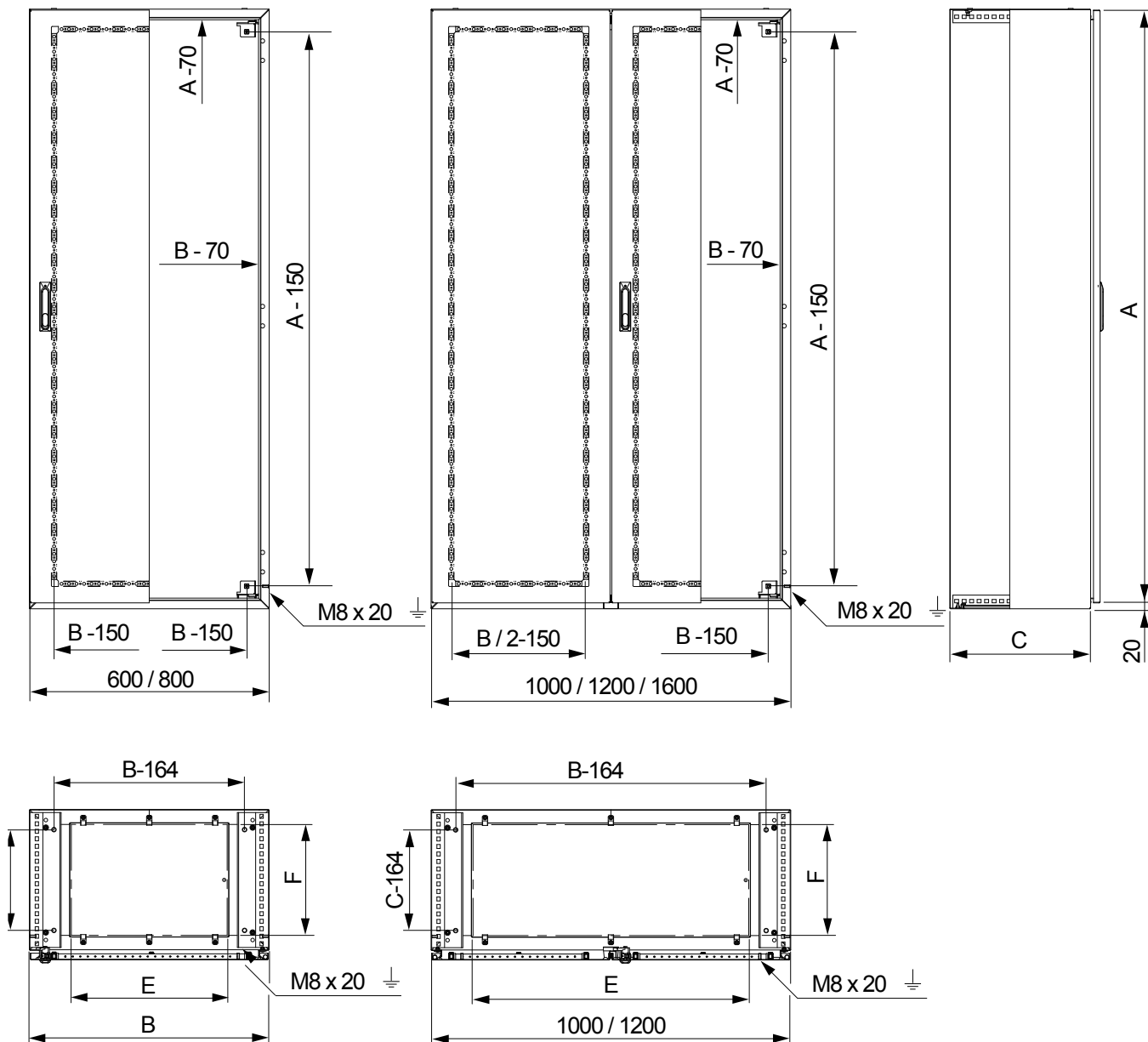

Enclosure width of 1000 (393.70) and 1200 (472.44) mm (in.)

Floor-standing enclosure			No. of front doors	No. of cable gland plates	Dimensions	
Height (A) mm (in.)	Width (B) mm (in.)	Depth (C) mm (in.)			E mm (in.)	F mm (in.)
1400 (55.12)	1000 (39.37)	300 (11.81)	1	1	720 (28.35)	270 (10.63)
1600 (62.99)	800 (31.50)	400 (15.75)	1	1	520 (20.47)	270 (10.63)
1800 (70.87)	600 (23.62)	400 (15.75)	1	1	520 (20.47)	270 (10.63)
1800 (70.87)	800 (31.50)	400 (15.75)	1	1	520 (20.47)	270 (10.63)
1800 (70.87)	1200 (47.24)	400 (15.75)	2	1	920 (36.22)	270 (10.63)
1800 (70.87)	1600 (62.99)	400 (15.75)	2	2	1320 (51.97)	270 (10.63)
2000 (78.74)	800 (31.50)	500 (19.68)	1	1	520 (20.47)	370 (14.57)
2000 (78.74)	1000 (39.37)	400 (15.75)	2	1	720 (28.35)	270 (10.63)
2000 (78.74)	1200 (47.24)	500 (19.68)	2	1	920 (36.22)	370 (14.57)
2000 (78.74)	1600 (62.99)	600 (23.62)	2	2	1320 (51.97)	470 (18.50)

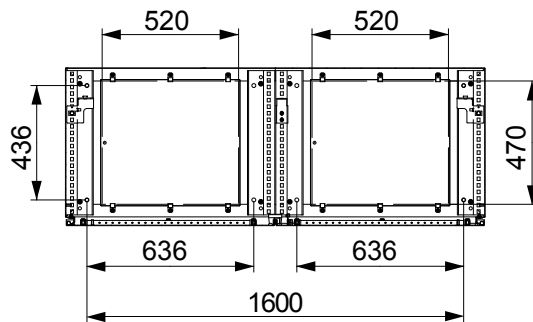

Enclosure width of 1600 (62.99) mm (in.)

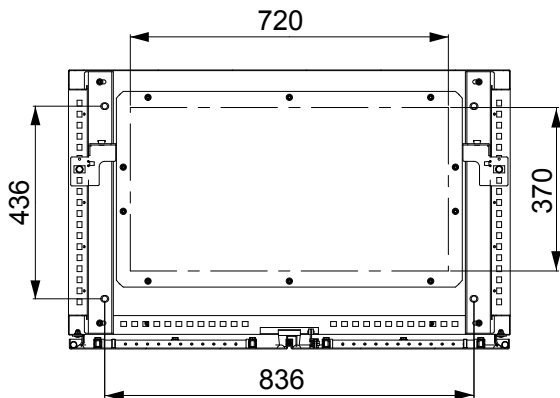
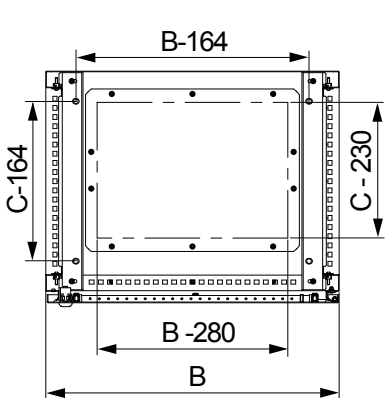
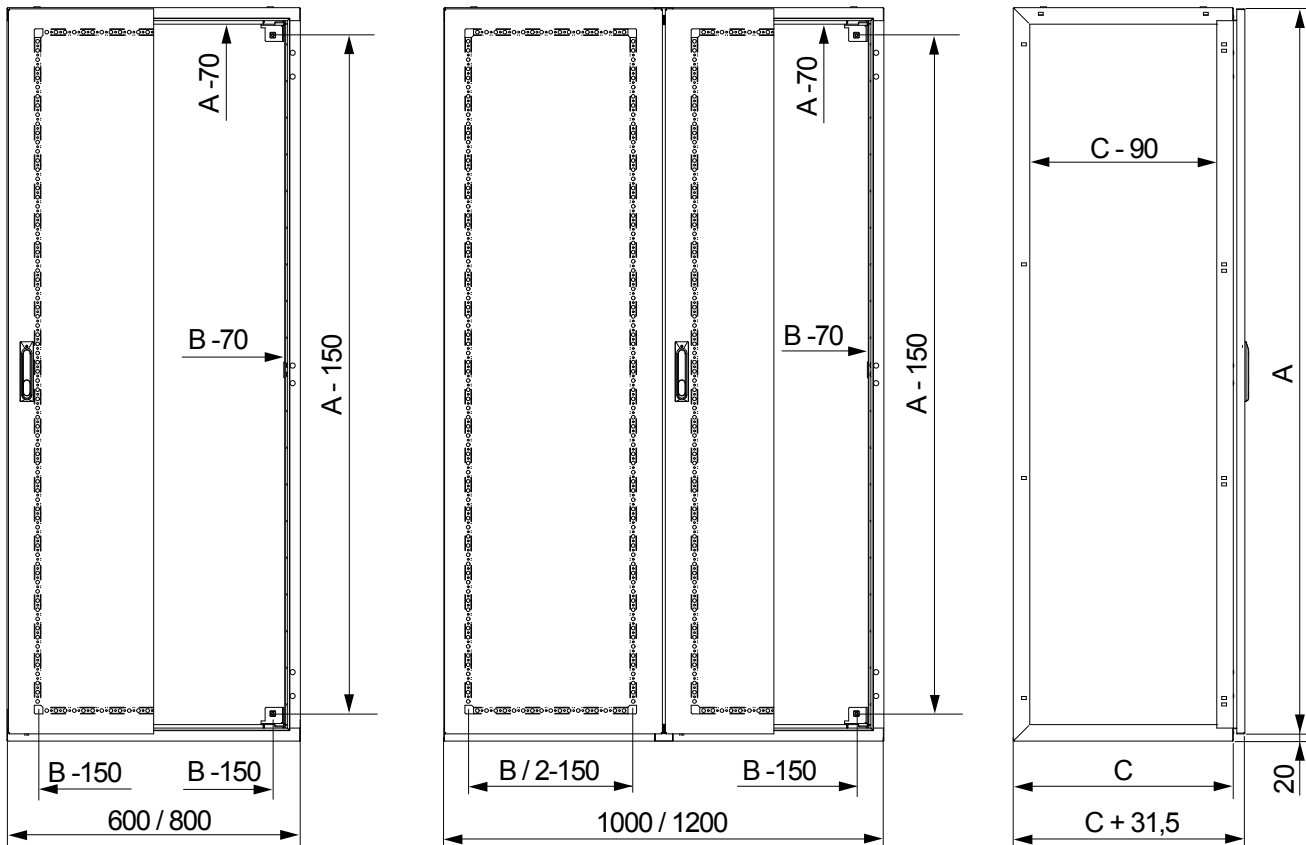

Enclosure width 1000 (39.37) mm (in.)

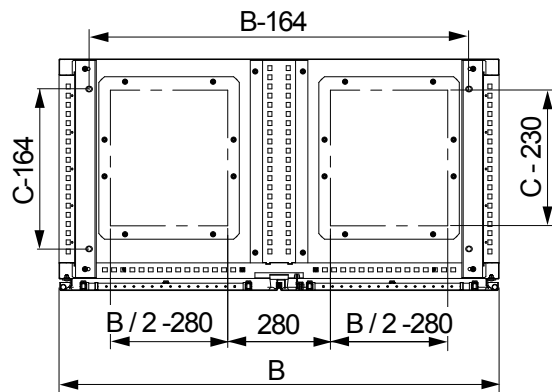

Enclosure width 1200 (47.24) mm (in.)

External dimensions			Number of front doors	No. of cable gland plates
Height (A) mm (in.)	Width (B) mm (in.)	Depth (C) mm (in.)		
1800 (70.87)	600 (23.62)	400 (15.75)	1	1
1800 (70.87)	800 (31.50)	400 (15.75)	1	1
1800 (70.87)	1200 (47.24)	400 (15.75)	2	2
2000 (78.74)	600 (23.62)	500 (19.68)	1	1
2000 (78.74)	800 (31.50)	400 (15.75)	1	1
2000 (78.74)	800 (31.50)	600 (23.62)	1	1
2000 (78.74)	1000 (39.37)	600 (23.62)	2	1
2000 (78.74)	1200 (47.24)	600 (23.62)	2	2

Technical changes reserved. Information provided without guarantee. Images are for illustrative purposes only.

Insulated Boxes

Thalassa TBS



Thalassa TBP



7

Thalassa PLS



Thalassa TBS - TBP Insulated industrial boxes

Introduction	170
Characteristics	171
Selection guide	172
Specific accessories	174
Common accessories	178

Thalassa PLS Insulated modular boxes



Introduction	182
Characteristics	183
Selection guide	184
Accessories	186

Technical Guide

Insulated industrial boxes Dimensions	190
--	------------

Insulated industrial boxes:

- ABS for conventional applications (IK07) in regular operating conditions
- Polycarbonate for enhanced impact resistance (IK08) and for outdoor applications or applications directly exposed to UV,
- polycarbonate with certified UL (cULus) rating according to UL50E: type 4 4X, IP66 rating for all ranges, protection against electrical impacts of Class II.



7



Easy to install

- 3 methods of fixing the box to its support



Smart

- Fixing studs on the cover.



Easy to use

- Only one tool is required:
A flat-bladed screwdriver.

For details consult our web site
www.se.com



Class II

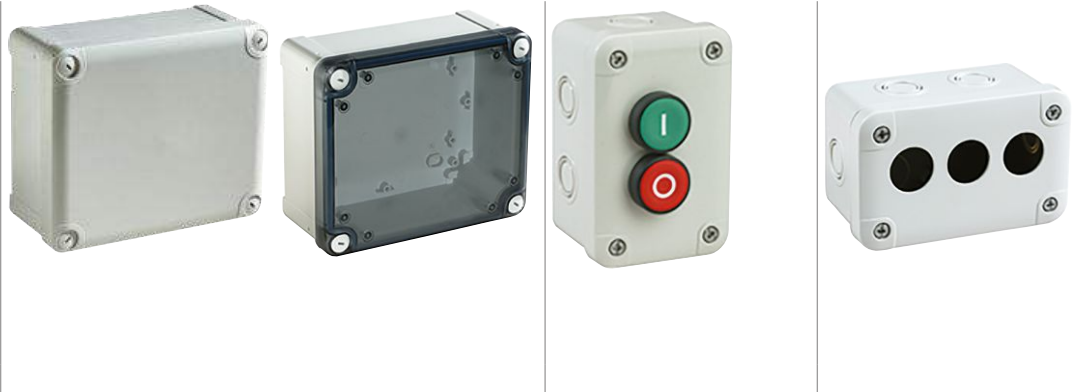

Characteristics	Universal boxes rated IP66	ABS boxes with push-buttons rated IP54	ABS boxes prepared for push-buttons
	Boxes can be coupled (exactly the same dimensions) with kit ref. 13934 . Locks from box size of 116 (4.57) x 116 (4.57) x 62 (2.44) mm (in.): <ul style="list-style-type: none"> • Cover locking by 4 plastic captive screws with coarse thread outside the sealed area, • Plumbable lock. Locks from box size of 138 (5.43) x 93 (3.66) x 72 (2.84) mm (in.): <ul style="list-style-type: none"> • The standard screws (flat-bladed screwdriver) can be replaced with other standardised screws. The 4 reinforced edges of the cover help ensure its robustness and perfect support during customisation operations. Adaptable hinges on all the 20 (0.79) and 40 (1.58) mm (in.) covers.		
Material	ABS boxes: <ul style="list-style-type: none"> • Transparent cover made of polycarbonate • Glow wire resistance: 650°C (1202°F) according to IEC 60695-2-11 • Operating temperature: -25°C (-13°F) ... 60°C (140°F) • Installation temperature: -15°C (5°F) 0°C (32°F) ... 40°C (104°F) Polycarbonate boxes: <ul style="list-style-type: none"> • Glow wire resistance: 960°C (1760°F) • Usage temperature: -25°C (-13°F) ... 80°C (176°F) • Installation temperature: -15°C (5°F) ... 60°C (140°F) 	ABS boxes: <ul style="list-style-type: none"> • Glow wire resistance: 650°C (1202°F) according to IEC 60695-2-11 • Usage temperature: -25°C (-13°F) ... 60°C (140°F) • Installation temperature: -15°C (5°F) 0°C (32°F) ... 40°C (104°F) 	
Color	<ul style="list-style-type: none"> • Body: RAL 7035 grey • Cover: RAL 7035 grey or transparent 		
Ingress protection rating	IP66 according to IEC 60529	IP54 according to IEC 60529	—
Mechanical protection rating	ABS: IK07 according to IEC 62262 Polycarbonate: IK08 according to IEC 62262	ABS: IK07 according to IEC 62262	
Standards	IEC 62208		
Certifications	<ul style="list-style-type: none"> • IEC 62208 certified by TÜV • UL 508A: Polycarbonate range • Product Environmental Profile • Class II according to IEC 61140 Polycarbonate range: <ul style="list-style-type: none"> • NEMA 4.4X according to NEMA 250 • Self-extinguishing: UL 94 V-0 	<ul style="list-style-type: none"> • IEC 62208 certified by TÜV • Product Environmental Profile • Class II according to IEC 61140 	
Installation	Fixing the box: <ul style="list-style-type: none"> • Outside the sealed sensitive volume by the 4 chimneys in the corners from box size of 138 (5.43) x 93 (3.66) x 72 (2.84) mm (in.) • Through the rear of the box by 2 or 4 elongated holes to be perforated • With fixing lugs from box size of 116 (4.57) x 116 (4.57) x 62 (2.44) mm (in.) (ref. NSYAEFTB) Outdoor installation, only for polycarbonate range: Compliant with IEC 62208 regarding type tests specified in §9.12 (resistance UV radiation) and §9.13 (resistance to corrosion). Equipment installation: <ul style="list-style-type: none"> • Studs for fixing the equipment in the body and the cover of the box by means of a Ø 4 (0.16) mm (in.) self-tapping screw (ref. NSYAMFSTB, screw Ø 4 x 10 (0.39) mm (in.) with Pozidriv and slotted head) • Option of installing rails, plates or other types of supports (card, etc.) • Spacers and stand-offs to be installed on the studs for adjusting the height of the equipment 		



Comment:

For outdoor use and based on the configuration of the installation, a canopy must be installed on the top of the boxes or the boxes should be installed under a shelter to protect them against the different weather conditions and to avoid water stagnation between body and lid. Anti-condensation valves must be installed to prevent condensation and deformations of the boxes.



Comment:

For dimensions see [page 190](#)

											Universal boxes with IP66			
											ABS IP66 IK07		PC-UL IP66 IK08	
														
											Opaque cover	Transparent cover	Opaque cover	Transparent cover
Overall external dimensions			Overall internal dimensions			Body	Cover	Minor pack.	Cover screw	References	References	References	References	
Height mm (in.)	Width mm (in.)	Depth mm (in.)	Height mm (in.)	Width mm (in.)	Depth mm (in.)	mm (in.)	mm (in.)							
74 (2.91)	74 (2.91)	54 (2.13)	65 (2.56)	65 (2.56)	47 (1.85)	37 (1.46)	10 (0.39)	5	Metal	NSYTBS775	-	NSYTBP775	-	
89 (3.50)	89 (3.50)	54 (2.13)	80 (3.15)	80 (3.15)	47 (1.85)	37 (1.46)	10 (0.39)	5	Metal	NSYTBS885	-	NSYTBP885	-	
116 (4.57)	74 (2.91)	62 (2.44)	105 (4.13)	65 (2.56)	55 (2.16)	45 (1.77)	10 (0.39)	5	Metal	NSYTBS1176	-	NSYTBP1176	-	
116 (4.57)	74 (2.91)	94 (3.70)	105 (4.13)	65 (2.56)	85 (3.35)	45 (1.77)	40 (1.58)	3	Metal	NSYTBS1179H	-	-	-	
116 (4.57)	116 (4.57)	62 (2.44)	105 (4.13)	105 (4.13)	55 (2.16)	45 (1.77)	10 (0.39)	5	Plastic	NSYTBS11116	-	NSYTBP11116	-	
116 (4.57)	116 (4.57)	133 (5.24)	105 (4.13)	105 (4.13)	125 (4.92)	45 (1.77)	80 (3.15)	2	Plastic	NSYTBS111113H	-	-	-	
138 (5.43)	93 (3.66)	72 (2.84)	125 (4.92)	80 (3.15)	65 (2.56)	45 (1.77)	20 (0.79)	2	Plastic	NSYTBS1397	NSYTBS1397T	NSYTBP1397	NSYTBP1397T	
164 (6.46)	121 (4.76)	87 (3.42)	150 (5.91)	105 (4.13)	80 (3.15)	60 (2.36)	20 (0.79)	2	Plastic	NSYTBS16128	NSYTBS16128T	NSYTBP16128	NSYTBP16128T	
192 (7.56)	121 (4.76)	87 (3.42)	175 (6.89)	105 (4.13)	80 (3.15)	60 (2.36)	20 (0.79)	2	Plastic	NSYTBS19128	NSYTBS19128T	NSYTBP19128	NSYTBP19128T	
192 (7.56)	121 (4.76)	105 (4.13)	175 (6.89)	105 (4.13)	100 (3.94)	60 (2.36)	40 (1.58)	2	Plastic	NSYTBS191210H	NSYTBS191210HT	NSYTBP191210H	NSYTBP191210HT	
192 (7.56)	164 (6.46)	87 (3.42)	175 (6.89)	150 (5.91)	80 (3.15)	60 (2.36)	20 (0.79)	1	Plastic	NSYTBS19168	NSYTBS19168T	NSYTBP19168	NSYTBP19168T	
192 (7.56)	164 (6.46)	105 (4.13)	175 (6.89)	150 (5.91)	100 (3.94)	60 (2.36)	40 (1.58)	1	Plastic	NSYTBS191610H	NSYTBS191610HT	NSYTBP191610H	NSYTBP191610HT	
241 (9.49)	194 (7.64)	87 (3.42)	225 (8.86)	175 (6.89)	80 (3.15)	60 (2.36)	20 (0.79)	1	Plastic	NSYTBS24198	NSYTBS24198T	NSYTBP24198	NSYTBP24198T	
241 (9.49)	194 (7.64)	107 (4.21)	225 (8.86)	175 (6.89)	100 (3.94)	80 (3.15)	20 (0.79)	1	Plastic	NSYTBS241910	NSYTBS241910T	NSYTBP241910	NSYTBP241910T	
241 (9.49)	194 (7.64)	107 (4.21)	225 (8.86)	175 (6.89)	100 (3.94)	60 (2.36)	40 (1.58)	1	Plastic	NSYTBS241910H	NSYTBS241910HT	NSYTBP241910H	NSYTBP241910HT	
241 (9.49)	194 (7.64)	127 (5.00)	225 (8.86)	175 (6.89)	120 (4.72)	80 (3.15)	40 (1.58)	1	Plastic	NSYTBS241912H	NSYTBS241912HT	NSYTBP241912H	NSYTBP241912HT	
291 (11.46)	241 (9.49)	88 (3.46)	275 (10.83)	225 (8.86)	80 (3.15)	60 (2.36)	20 (0.79)	1	Plastic	NSYTBS29248	NSYTBS29248T	NSYTBP29248	NSYTBP29248T	
291 (11.46)	241 (9.49)	128 (5.04)	275 (10.83)	225 (8.86)	120 (4.72)	100 (3.94)	20 (0.79)	1	Plastic	NSYTBS292412H	NSYTBS292412HT	NSYTBP292412H	NSYTBP292412HT	
291 (11.46)	241 (9.49)	128 (5.04)	275 (10.83)	225 (8.86)	120 (4.72)	60 (2.36)	60 (2.36)	1	Plastic	NSYTBS292412H	NSYTBS292412HT	NSYTBP292412H	NSYTBP292412HT	
291 (11.46)	241 (9.49)	168 (6.61)	275 (10.83)	225 (8.86)	160 (6.30)	100 (3.94)	60 (2.36)	1	Plastic	NSYTBS292416H	NSYTBS292416HT	NSYTBP292416H	NSYTBP292416HT	
341 (13.42)	291 (11.46)	128 (5.04)	325 (12.80)	275 (10.83)	120 (4.72)	100 (3.94)	20 (0.79)	1	Plastic	NSYTBS342912	NSYTBS342912T	NSYTBP342912	NSYTBP342912T	
341 (13.42)	291 (11.46)	168 (6.61)	325 (12.80)	275 (10.83)	160 (6.30)	100 (3.94)	60 (2.36)	1	Plastic	NSYTBS342916H	NSYTBS342916HT	NSYTBP342916H	NSYTBP342916HT	

7



Mounting plates for adjustment to mounting surface

Installation:

- Fixing by means of Ø 4 (0.16) mm (in.) self-tapping screws, Pozidrive and slotted head, ref. **NSYAMFSTB**

Supply:

Plates supplied without screws

Box					Mounting plate dimensions		Mounting plates	
Height mm (in.)	Width mm (in.)	A mm (in.)	B mm (in.)	Minor pack.	References	References		
192 (7.56)	164 (6.46)	168.5 (6.63)	140 (5.51)	1	NSYAMP1916TB	NSYAMPA1916TB	Material: Galvanized steel	Material: Insulated polyester plate reinforced with fiberglass, halogen-free: Glow wire resistance 750°C (1382°F) according to IEC 60695-2-11.
241 (9.49)	194 (7.64)	215 (8.46)	168.5 (6.63)	1	NSYAMP2419TB	NSYAMPA2419TB		
291 (11.46)	241 (9.49)	265 (10.43)	215 (8.46)	1	NSYAMP2924TB	NSYAMPA2924TB		
341 (13.42)	291 (11.46)	315 (12.40)	265 (10.43)	1	NSYAMP3429TB	NSYAMPA3429TB		

Mounting plates

Material:
Galvanized steel

Thickness: 15 (0.59)/10⁶ mm (in.)

Material:
Insulated polyester plate reinforced with fiberglass, halogen-free: Glow wire resistance 750°C (1382°F) according to IEC 60695-2-11.

Thickness: 25 (0.98)/10⁶ mm (in.)

Button description

- Emergency-off function with a red, Ø 40 (1.58) mm (in.), turn-to-unlock palm button.
 - Start/stop function with 2 push-buttons.
 - Up/down/stop function with 3 push buttons.
- Ref. **XALEK1702** houses an emergency switching off palm button with mechanical locking according to standards IEC 60364-5-53 and 60947-5-5.

Technical features of the switches:

- NC switch with positive opening manoeuvre according to IEC 60947-5-1 appendix K,
- Mechanical durability of the emergency switch: 0.1 million cycles,
- Mechanical durability of the NC and NO switches: 5 million cycles,
- Protection against short circuits: 10 A.

Comment:

For dimensions see [page 190](#)

Boxes equipped with IP54 ABS buttons | ABS button boxes, to be equipped



Overall external dimensions			Overall internal dimensions			Body mm (in.)	Cover mm (in.)	Minor pack.	No. of holes	Function	References	References
Height mm (in.)	Width mm (in.)	Depth mm (in.)	Height mm (in.)	Width mm (in.)	Depth mm (in.)							
74 (2.91)	74 (2.91)	83 (3.27)	-	-	-	-	-	1	-	Emergency switching off	XALEK170	-
116 (4.57)	74 (2.91)	62 (2.44)	105 (4.13)	65 (2.56)	55 (2.16)	45 (1.77)	10 (0.39), Grey	5	2	-	-	XALE2
116 (4.57)	74 (2.91)	62 (2.44)	105 (4.13)	65 (2.56)	55 (2.16)	45 (1.77)	10 (0.39), Grey	5	3	-	-	XALE3
116 (4.57)	74 (2.91)	75 (2.95)	-	-	-	-	-	1	-	Start/stop	XALE2141	-
116 (4.57)	74 (2.91)	75 (2.95)	-	-	-	-	-	1	-	Up/down/stop	XALE3255	-

Function	Push-button type	Type NO
Emergency switching off	Locking, red	1
Start/stop		
Start	Flush, green	1
Stop	Projecting, red	-
Up/down/stop		
Up	Flush, black	-
Down	Flush, white	-
Stop	Projecting, red	-

Function	Push-button type	Type NC
Emergency switching off	Locking, red	1
Start/stop		
Start	Flush, green	-
Stop	Projecting, red	1
Up/down/stop		
Up	Flush, black	-
Down	Flush, white	-
Stop	Projecting, red	1

Function	Push-button type	Type C/O
Emergency switching off	Locking, red	-
Start/stop		
Start	Flush, green	-
Stop	Projecting, red	-
Up/down/stop		
Up	Flush, black	1
Down	Flush, white	1
Stop	Projecting, red	-



Coupling kit



13934

- The coupling kit allows you to join several boxes with dimensions from 138 (5.43) x 93 (3.66) mm (in.).
- Material: Polystyrene, glow wire resistance: 650°C (1202°F) according to IEC 60695-2-11
 - Ingress protection rating: IP66 according to IEC 60529
 - Installation: The kit is installed by drilling a hole with Ø 32 (1.26) mm (in.) in the boxes to be coupled

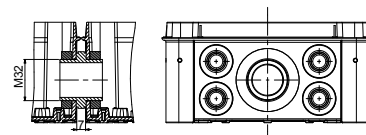

Supply:
The kit consists of 2 linking parts, nuts and seals

Characteristics	Drilling Ø mm (in.)	Minor pack.	Reference
Coupling kit	32 (1.26)	1	13934

Sealed anti-condensation valve



NSYCAG12LPH1

- Controls the pressure to avoid condensation and/or deformations of the boxes due to internal temperature changes. Protection of equipment for luminaires, industrial control, transportation, pumps, etc.
- Material: PA6-V-2, acrylic co-polymer membrane, water and oil repellent
 - Ingress protection rating: IP68
 - Installation: The valve is installed by drilling a hole with Ø 12 (0.47) mm (in.) in the box
 - Usage temperature: -40°C (-40°F) ... 105°C (221°F)
 - Permeability: Air flow under ΔP = 0.7 bar
 - Pressure difference: Condition for IP68

Supply:
10 valves, nuts and seals

Characteristics	Permeability	Pressure difference	Drilling Ø mm (in.)	Minor pack.	Reference
Sealed anti-condensation valve IP68	16 litres/h	ΔP < 1 bar	12 (0.47)	1	NSYCAG12LPH1
Sealed anti-condensation valve IP68	120 litres/h	ΔP < 0.1 bar	12 (0.47)	1	NSYCAG12LPH2

Cover accessories Set

7



NSYAEDST820TB



NSYAEDSB520TB



NSYAEDS20TB

- The Thalassa boxes are delivered as standard with slotted-head screws for flat-bladed screwdrivers from 4 (0.16) to 5.5 (0.22) mm (in.).
- With box sizes from 138 (5.43) x 93 (3.66) x 72 (2.84) mm (in.), these screws can be replaced for screws with different standardised heads to comply with most cases.
- After removing the standard screw, simply position the new screw by pressing on it.
- The adapter clips (intermediate parts for tightening the cover on the body of the box) are the same as those for the standard screws. They are not delivered with the shaped screws.
- A single key for opening the boxes as well as the other enclosures of your installation.

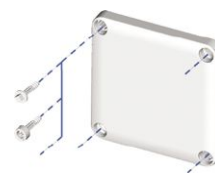

Supply:
Set of 4 shape screws

Characteristics	Minor pack.	Reference
Triangular screw Ø 8 (0.32) mm (in.), for Thalassa boxes, Height of the lid 20 (0.79) mm (in.)	1	NSYAEDST820TB
Double-bar screw Ø 5 (0.20) mm (in.), for Thalassa boxes, Height of the lid 20 (0.79) mm (in.)	1	NSYAEDSB520TB
Spare standard plastic screw for Thalassa boxes, Height of the lid 20 (0.79) mm (in.)	1	NSYAEDS20TB
Spare standard plastic screw for Thalassa boxes, Height of the lid 40 (1.58) mm (in.)	1	NSYAEDS40TB
Spare standard plastic screw for Thalassa boxes, Height of the lid 60 (2.36) mm (in.)	1	NSYAEDS60TB

Cover accessories Pack



NSYAEDKTB

- The handle (or thumbwheel) allows the screws to be handled without any tools. It is ideally combined with a box equipped with hinges.
- It snaps onto the head of the standard plastic screw.

Supply:
Pack of 4 handles

Characteristics	Minor pack.	Reference
Handles	1	NSYAEDKTB

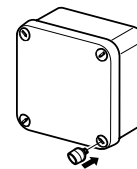

Hinges, set of 2 hinges



NSYAEDH20TB

- The hinges can be adapted to all covers with a height of 20 (0.79) and 40 (1.58) mm (in.) with dimensions from 138 (5.43) x 93 (3.66) mm (in.).
- The hinge allows the lid to open fully to 200°.
- Ingress protection rating: IP66 according to IEC 60529
- Installation: The hinge does not require any machining and is installed easily even with the box already equipped
- Maximum load: Hinged cover: 10 (22.05) kg (lbs.)/m²

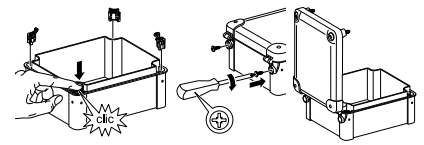

Supply:
The hinges (2 per set) are delivered with the fixings, minor pack 1

Characteristics	Height of the lid mm (in.)	References
Set of 2 hinges	20	NSYAEDH20TB
Set of 2 hinges	40	NSYAEDH40TB

Hinges, Set of 4 fixing lugs



NSYAEFTB

- Plastic fixing lugs for installation on boxes with dimensions from 116 (4.57) x 116 (4.57) mm (in.).
- Option of vertical or horizontal installation.
- Installation: Installation by a single screw at the last moment, with the box closed and equipped
- Maximum load: Body: 30 (66.14) kg (lbs.)/m², Cover: 10 (22.05) kg (lbs.)/m²

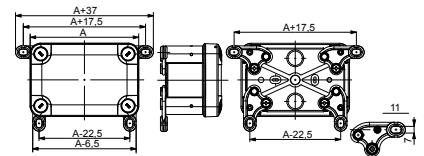

Supply:
4 lugs + screws, minor pack 1

Characteristics	Reference
Set of 4 fixing lugs	NSYAEFTB

Mounting plates



NSYAMP1916TB

- Mounting plates made to adapt to all usage scenarios.
- Material: Galvanized steel
- Thickness: 15 (0.59)/10^e mm (in.)
- Installation: Fixing by means of Ø 4 (0.16) mm (in.) self-tapping screws, Pozidrive and slotted head, ref. **NSYAMFSTB**

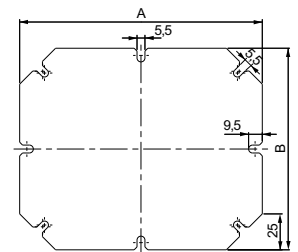

Supply:
Plates supplied without screws

Characteristics	Box		Dimensions		Minor pack.	References
	Height mm (in.)	Width mm (in.)	A mm (in.)	B mm (in.)		
Mounting plate	192 (7.56)	164 (6.46)	168.5 (6.63)	140 (5.51)	1	NSYAMP1916TB
Mounting plate	241 (9.49)	194 (7.64)	215 (8.46)	168.5 (6.63)	1	NSYAMP2419TB
Mounting plate	291 (11.46)	241 (9.49)	265 (10.43)	215 (8.46)	1	NSYAMP2924TB
Mounting plate	341 (13.42)	291 (11.46)	315 (12.40)	265 (10.43)	1	NSYAMP3429TB

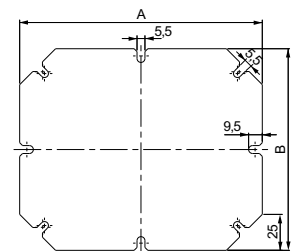

Supply:
Plates supplied without screws

- Mounting plates made to adapt to all usage scenarios.
- Material: Insulated polyester plate reinforced with fiberglass, halogen-free: Glow wire resistance 750°C (1382°F)
- Thickness: 25 (0.98)/10^e mm (in.)
- Installation: Fixing by means of Ø 4 (0.16) mm (in.) self-tapping screws, Pozidrive and slotted head, ref. **NSYAMFSTB**



NSYAMPA1916TB

Characteristics	Box		Dimensions		Minor pack.	References
	Height mm (in.)	Width mm (in.)	A mm (in.)	B mm (in.)		
Insulated mounting plate	192 (7.56)	164 (6.46)	168.5 (6.63)	140 (5.51)	1	NSYAMPA1916TB
Insulated mounting plate	241 (9.49)	194 (7.64)	215 (8.46)	168.5 (6.63)	1	NSYAMPA2419TB
Insulated mounting plate	291 (11.46)	241 (9.49)	265 (10.43)	215 (8.46)	1	NSYAMPA2924TB
Insulated mounting plate	341 (13.42)	291 (11.46)	315 (12.40)	265 (10.43)	1	NSYAMPA3429TB

Symmetric DIN rails

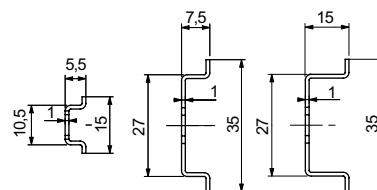

- A 15 (0.59) x 5 (0.20) mm (in.) rail is provided for the compact terminal blocks.
- Installation: Fixing of the rails with Ø 4 (0.16) mm (in.) self-tapping screws, (not included), Pozidrive and slotted head, ref. **NSYAMFSTB**

Supply:
Supplied without screws
(except for the 15 (0.59) x 5 (0.20) mm (in.) rails)



NSYAMRD11155TB

Characteristics	Height mm (in.)	Depth mm (in.)	Length mm (in.)	Box mm (in.)	References
Symmetric DIN rail	15 (0.59)	5 (0.20)	97 (3.82)	105 (4.13)	NSYAMRD11155TB
Symmetric DIN rail	15 (0.59)	5 (0.20)	140 (5.51)	150 (5.91)	NSYAMRD16155TB
Symmetric DIN rail	15 (0.59)	5 (0.20)	168 (6.61)	175 (6.89)	NSYAMRD19155TB
Symmetric DIN rail	15 (0.59)	5 (0.20)	214 (8.42)	225 (8.86)	NSYAMRD24155TB
Symmetric DIN rail	15 (0.59)	5 (0.20)	264 (10.39)	275 (10.83)	NSYAMRD29155TB
Symmetric DIN rail	15 (0.59)	5 (0.20)	316 (12.44)	325 (12.80)	NSYAMRD34155TB



NSYAMRD11357TB

Symmetric DIN rail	35 (1.38)	7.5 (0.30)	97 (3.82)	105 (4.13)	NSYAMRD11357TB
Symmetric DIN rail	35 (1.38)	7.5 (0.30)	140 (5.51)	150 (5.91)	NSYAMRD16357TB
Symmetric DIN rail	35 (1.38)	7.5 (0.30)	168 (6.61)	175 (6.89)	NSYAMRD19357TB
Symmetric DIN rail	35 (1.38)	7.5 (0.30)	214 (8.42)	225 (8.86)	NSYAMRD24357TB
Symmetric DIN rail	35 (1.38)	7.5 (0.30)	264 (10.39)	275 (10.83)	NSYAMRD29357TB
Symmetric DIN rail	35 (1.38)	7.5 (0.30)	316 (12.44)	325 (12.80)	NSYAMRD34357TB



NSYAMRD243515TB

Symmetric DIN rail	35 (1.38)	15 (0.59)	214 (8.42)	225 (8.86)	NSYAMRD243515TB
Symmetric DIN rail	35 (1.38)	15 (0.59)	264 (10.39)	275 (10.83)	NSYAMRD293515TB
Symmetric DIN rail	35 (1.38)	15 (0.59)	316 (12.44)	325 (12.80)	NSYAMRD343515TB

7

Screws for rails









NSYAMFSTB

- Ø 4 (0.16) x 10 (0.39) mm (in.)

Supply:
Pack of 100 screws

Characteristics	References
Screws Ø 4 (0.16) mm (in.), height 10 (0.39) mm (in.)	NSYAMFSTB

Simple-1	Simple-2	Simple-3	Simple-4	Simple-5	Synthetic snap-in cable gland
					
Mixed membrane entries for enclosure thickness 20 (0.79)/10 ^e - 32 (1.26)/10 ^e mm (in.)	PVC adjustable cone-shaped entries for enclosure thickness 30 (1.18)/10 ^e - 32 (1.26)/10 ^e mm (in.)	Quick cable entries for enclosure thickness 10 (0.39)/10 ^e - 40 (1.58)/10 ^e mm (in.) (5 (0.20)/10 ^e - 20 (0.79)/10 ^e mm (in.) for ref. IMT36179).	PVC adjustable cone-shaped entries for PG tubes or for enclosure thickness 12 (0.47)/10 ^e - 15 (0.59)/10 ^e mm (in.)	ISO cable gland	Without thread. Easy assembly and dis-assembly. Suitable for walls from 0.5 (0.02) to 4 (0.16) mm (in.) thick.
ISM71071 ISM71072 ISM71073 ISM71074 IMT36172 IMT36173	NSYECPC3 NSYECPC5 NSYECPC6 NSYECPC9 NSYECPC15	IMT36179 IMT36180 IMT36181 IMT36182 IMT36183 IMT36184 IMT36185	NSYEC7	ISM71501 ISM71502 ISM71503 ISM71504 ISM71505 ISM71506 IMT36150	NSYCGSP16 NSYCGSP20 NSYCGSP25 NSYCGSP32 NSYCGSP40

Accessories bag for enclosure TBS/TBP



NSYTBPASBS

Simple-1

Characteristics	References
Spare Parts	NSYTBPASBS

- Mixed membrane entries for enclosure thickness 20 (0.79)/10^e - 32 (1.26)/10^e mm (in.)
- Material: SBS
- Color: RAL 7035 grey or RAL 9010 white
- Cable entry material: Soft membrane
- Cable glands to be fitted: Not applicable
- Installation options: On cable gland plate or directly on enclosure
- Flexibility of the installation: Low
- Reversibility: Medium
- Ingress protection rating: IP55 according to IEC 60529

- Cable retention: Low
- Cable diameter mm (in.): From 20 (0.79) to 40 (1.58)
- Cable Installation time: Fast
- Quantity of cables to be fitted for a given surface: +
- Cable entries for cables with connectors: No
- Cut-out dimensions mm (in.): Various circular hole diameters according to cable diameter
- External dimensions mm (in.): From Ø 23 (0.91) to 44 (1.73)
- Flame resistance: 750°C (1382°F)

Supply:
Minor packaging of 10 pieces



ISM71074

Characteristics	Drill hole Ø mm (in.)	Cable / conduit Ø mm (in.)	References
Mixed membrane entries for IP55 direct cable entries, RAL 9010	23 (0.91)	4 (0.16) - 20 (0.79)	IMT36172
Mixed membrane entries for IP55 direct cable entries, RAL 9010	29 (1.14)	4 (0.16) - 25 (0.98)	IMT36173
Mixed membrane entries for IP55 direct cable entries, RAL 7035	23 (0.91)	4 (0.16) - 20 (0.79)	ISM71071
Mixed membrane entries for IP55 direct cable entries, RAL 7035	29 (1.14)	4 (0.16) - 25 (0.98)	ISM71072
Mixed membrane entries for IP55 direct cable entries, RAL 7035	36 (1.42)	4 (0.16) - 32 (1.26)	ISM71073
Mixed membrane entries for IP55 direct cable entries, RAL 7035	44 (1.73)	4 (0.16) - 40 (1.58)	ISM71074

Simple-2

- PVC adjustable cone-shaped entries for enclosure thickness 30 (1.18)/10° - 32 (1.26)/10° mm (in.)
- Material: PVC
- Cable entry material: Soft membrane
- Cable glands to be fitted: Not applicable
- Installation options:
 - On cable gland plate or directly on enclosure
- Flexibility of the installation: Low
- Reversibility: Medium
- Ingress protection rating: IP55 according to IEC 60529
- Cable retention: Low
- Cable diameter mm (in.): From 5 (0.20) to 87 (3.42)
- Cable Installation time Fast
- Quantity of cables to be fitted for a given surface: +
- Cable entries for cables with connectors: No
- Cut-out dimensions mm (in.): Various circular hole diameters according to cable diameter
- External dimensions mm (in.): From Ø 25 (0.98) to 98 (3.86)

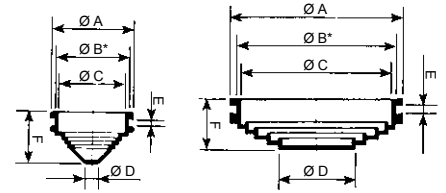

Supply:
NSYECPC3 50 cable entries, **NSYECPC5** and **NSYECPC6** each 25 cable entries, **NSYECPC9** and **NSYECPC15** each 10 cable entries



NSYECPC15

Characteristics	Dimensions mm (in.)						Capacity		References
	Ø A	Ø B	Ø C	Ø D	E	F	Cable Ø mm (in.)	Tube	
PVC adjustable cone-shaped entry 25 (0.98) x 3 (0.12) mm (in.)	25 (0.98)	21.5 (0.85)	18 (0.71)	5 (0.20)	3.2 (0.13)	13 (0.51)	5 (0.20)-18 (0.71)	PG 9-11	NSYECPC3
PVC adjustable cone-shaped entry 32 (1.26) x 3 (0.12) mm (in.)	33 (1.30)	29.5 (1.16)	26 (1.02)	5 (0.20)	3.2 (0.13)	20 (0.79)	5 (0.20)-26 (1.02)	PG 9-16	NSYECPC5
PVC adjustable cone-shaped entry 43 (1.69) x 3 (0.12) mm (in.)	43 (1.69)	38.5 (1.52)	36 (1.42)	5 (0.20)	3.2 (0.13)	22 (0.87)	5 (0.20)-36 (1.42)	PG 9-21	NSYECPC6
PVC adjustable cone-shaped entry 70 (2.76) x 3 (0.12) mm (in.)	70 (2.76)	63 (2.48)	60 (2.36)	28 (1.10)	3 (0.12)	20 (0.79)	28 (1.10)-60 (2.36)	PG 21-48	NSYECPC9
PVC adjustable cone-shaped entry 98 (3.86) x 3 (0.12) mm (in.)	98 (3.86)	90 (3.54)	87 (3.42)	28 (1.10)	3 (0.12)	23 (0.91)	28 (1.10)-87 (3.42)	PG 21-48	NSYECPC15

Simple-3

- Quick cable entries for enclosure thickness 10/10° - 40/10° mm (5/10° - 20/10° mm for ref. **IMT36179**).
- Material: EPDM plastic
- Color: Grey cable entries: NCS 5500; Black cable entries: NCS 9000
- Cable entry material: Combined
- Cable glands to be fitted: Not applicable
- Installation options: On cable gland plate or directly on enclosure
- Flexibility of the installation: Low
- Reversibility: Medium
- Ingress protection rating: IP67 according to IEC 60529
- Cable retention: Medium
- Cable diameter mm (in.): From 12 (0.47) to 50 (1.97)
- Cable Installation time: Fast
- Quantity of cables to be fitted for a given surface: +
- Cable entries for cables with connectors: No3
- Cut-out dimensions mm (in.): Various circular hole diameters according to cable diameter
- External dimensions mm (in.): From Ø 12.5 (0.49) to 50.7 (2.00)
- Flame resistance: 750°C (1382°F)

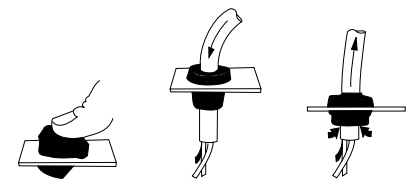

Supply:
 50 (M12 to M32)
 25 (M40 and M50)



IMT36179

Characteristics	Dimensions			References
	ISO	Drill hole Ø mm (in.)	Cable Ø mm (in.)	
Quick cable entries	M12	12.5 (0.49)	3 (0.12) - 5 (0.20)	IMT36179
Quick cable entries	M16	16 (0.63)	5 (0.20) - 7 (0.28)	IMT36180
Quick cable entries	M20	20.3 (0.80)	7 (0.28) - 10 (0.39)	IMT36181
Quick cable entries	M25	25.3 (1.00)	10 (0.39) - 14 (0.55)	IMT36182
Quick cable entries	M32	32.4 (1.28)	14 (0.55) - 20 (0.79)	IMT36183
Quick cable entries	M40	40.7 (1.60)	20 (0.79) - 26 (1.02)	IMT36184
Quick cable entries	M50	50.7 (2.00)	26 (1.02) - 35 (1.38)	IMT36185

PVC adjustable cone-shaped entries

- PVC adjustable cone-shaped entries for PG tubes or for enclosure thickness 12 (0.47)/10* - 15 (0.59)/10* mm (in.)
- Material: PVC
- Color: Black
- Cable entry material: Combined
- Cable glands to be fitted: Not applicable
- Installation options: On cable gland plate or directly on enclosure
- Flexibility of the installation: Low
- Reversibility: Medium
- Ingress protection rating: IP55 according to IEC 60529
- Cable retention: Low
- Cable diameter mm (in.): From 16 (0.63) to 44 (1.73)
- Cable Installation time: Fast
- Quantity of cables to be fitted for a given surface: +
- Cable entries for cables with connectors: No
- Cut-out dimensions mm (in.): Various circular hole diameters according to cable diameter
- External dimensions mm (in.): From Ø 25 (0.98) to 52 (2.05)

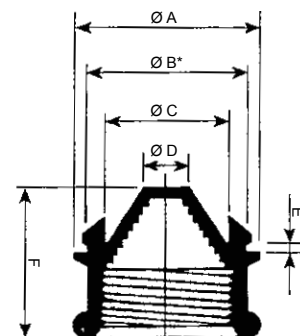

Supply:
25 cable entries



NSYEC7

Characteristics	Dimensions mm (in.)						Capacity		References
	Ø A	Ø B	Ø C	Ø D	E	F	Cable Ø mm (in.)	Tube	
PVC adjustable cone-shaped entries	52 (2.05)	48.5 (1.91)	44 (1.73)	13 (0.51)	1.5 (0.06)	30 (1.18)	13 (0.51) to 44 (1.73)	PG 36	NSYEC7

Simple-5

- ISO cable gland
- Material: PA6 Polyamide, neoprene gasket
- Color: RAL 7035 grey
- Cable entry material: Combined
- Installation options: On cable gland plate or directly on enclosure
- Flexibility of the installation: Low
- Reversibility: Medium
- Ingress protection rating: IP68
- Cable retention: High
- Cable diameter mm (in.): From 12 (0.47) to 40 (1.58) mm (in.)
- Cable Installation time: Slow
- Quantity of cables to be fitted for a given surface: +
- Cable entries for cables with connectors: No
- Cut-out dimensions mm (in.): Various circular hole diameters according to cable diameter
- External dimensions mm (in.): From Ø 15 (0.59) to 46 (1.81)
- Certificates: Glow wire resistance: 960°C (1760°F)
- Standard: Compliance with VDE, UL and CSA
- Flame resistance: 750 0°C (32°F)

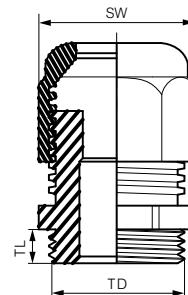

Supply:
The cable glands are supplied with nuts Pack of 20 (M12 to M20), of 10 (M25 and M32), of 5 (M40)



ISM71503

Characteristics	Dimensions						References
	Cable Ø mm (in.)	Drill hole Ø mm (in.)	TD mm (in.)	TL mm (in.)	SW mm (in.)		
Cable gland M12, RAL 7035	3 (0.12) / 6.5 (0.26)	12.2 (0.48) (0 + 0.2)	12 (0.47)	6 (0.24)	15 (0.59)	ISM71501	
Cable gland M16, RAL 7035	4 (0.16) / 8 (0.32)	16.2 (0.64) (0 + 0.2)	16 (0.63)	8 (0.32)	19 (0.75)	ISM71502	
Cable gland M20, RAL 7035	6 (0.24) / 12 (0.47)	20.2 (0.80) (0 + 0.2)	20 (0.79)	10 (0.39)	24 (0.94)	ISM71503	
Safety Cable gland M20, RAL 3000	6 (0.24) / 12 (0.47)	20.2 (0.80) (0 + 0.2)	20 (0.79)	10 (0.39)	24 (0.94)	IMT36150	
Cable gland M25, RAL 7035	11 (0.43) / 17 (0.67)	25.2 (0.99) (0 + 0.2)	25 (0.98)	8 (0.32)	29 (1.14)	ISM71504	
Cable gland M32, RAL 7035	15 (0.59) / 21 (0.83)	32.2 (1.27) (0 + 0.3)	32 (1.26)	10 (0.39)	36 (1.42)	ISM71505	
Cable gland M40, RAL 7035	19 (0.75) / 28 (1.10)	40.5 (1.59) (0 + 0.3)	40 (1.58)	10 (0.39)	46 (1.81)	ISM71506	

Synthetic snap-in cable gland

- Without thread.
- Easy assembly and disassembly.
- Suitable for walls from 0.5 (0.02) to 4 (0.16) mm (in.) thick.
- Material: PA6 Polyamide, neoprene gasket
- Color: RAL 7035 grey, RAL 7001, RAL 9005. Other colors on demand
- Cable entry material: Non-armoured
- Installation options:
 - On cable gland plate or directly on enclosure
- Flexibility of the installation: Low
- Reversibility: Medium
- Ingress protection rating: IP66
- Cable retention: High
- Cable diameter mm (in.): From 16 (0.63) to 40 (1.58) mm (in.)
- Cable Installation time: Slow
- Quantity of cables to be fitted for a given surface: +
- Cable entries for cables with connectors: No
- Thread type: Metric EN 60423
 - Other types are available on demand
- Cut-out dimensions mm (in.): Various circular hole diameters according to cable diameter
- External dimensions mm (in.): From Ø 22 (0.87) to 46 (1.81)
- Certificates: UL 94 V-2 (except for the size M40)
- Standard: DIN EN 62444, UL 514B, UL 514B§8.26.7
- Temperature range: -20°C (-4°F) to +100°C (212°F)

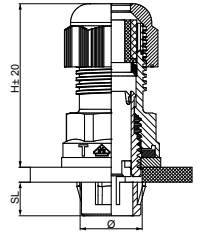

Supply:
The cable glands are supplied with nuts Pack of 20 (M16 and M20), of 10 (M25 and M32), of 5 (M40)



NSYCGSP16

Characteristics	Dimensions mm (in.)								References
	Ø	Ø min	Ø max	Drill Ø	SL	SD	H		
Synthetic snap-in cable gland	M16	5 (0.20)	10 (0.39)	16.2 to 16.4	9 (0.35)	15.9 (0.63)	42.5 (1.67)	22 (0.87)	NSYCGSP16
Synthetic snap-in cable gland	M20	6 (0.24)	12 (0.47)	20.2 to 20.4	9 (0.35)	19.9 (0.78)	41.5 (1.63)	24 (0.94)	NSYCGSP20
Synthetic snap-in cable gland	M25	11 (0.43)	17 (0.67)	25.2 to 25.4	9 (0.35)	24.9 (0.98)	43.5 (1.71)	29 (1.14)	NSYCGSP25
Synthetic snap-in cable gland	M32	15 (0.59)	21 (0.83)	32.2 to 32.4	9 (0.35)	31.9 (1.26)	49.5 (1.95)	36 (1.42)	NSYCGSP32
Synthetic snap-in cable gland	M40	19 (0.75)	8 (0.32)	40.2 to 40.4	11.5 (0.45)	39.9 (1.57)	56 (2.20)	46 (1.81)	NSYCGSP40

Snap-in cable gland disassembling tool

- Material: Plastic



NSYDT16



NSYDT20

Characteristics	Ø	References
Tool to quickly disassemble cable gland	M16	NSYDT16
Tool to quickly disassemble cable gland	M20	NSYDT20
Tool to quickly disassemble cable gland	M25	NSYDT25
Tool to quickly disassemble cable gland	M32	NSYDT32
Tool to quickly disassemble cable gland	M40	NSYDT40



PLS boxes: Polyester rear and PC transparent cover with wing screws for manual opening



7

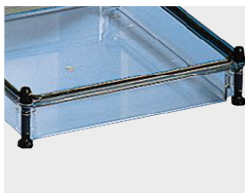

Protection

IP66.
Gasket between body and cover.
IK09.
Insulation Class II.

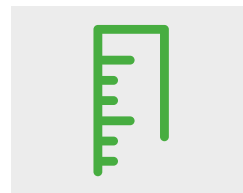

Modular

The dimensions of the sides, multiples of 9 cm, allow the creation of assemblies.



Easy

Bosses with inserts, at the rear of the body, for fixing plates or various supports.

For details consult our web site
www.se.com



Prolonged exposure to UV radiation, wind and rain can cause aesthetics changes in the external surface of the enclosure. Without affecting the technical properties according to IEC 62208. For long exposure applications, it is recommended to use painted enclosures available through the P&S offer.



Class II



Complete box

Characteristics	NSYPLS5454AG	NSYPLS1827G	NSYPLSC5472AG	NSYPLSC1827G	NSYPLSP1827G
-----------------	--------------	-------------	---------------	--------------	--------------

- Insulated boxes that can be coupled by all their side surfaces, allowing the creation of the greatest variety of modular assemblies.
- The product references show the two lateral dimensions in cm.
- 14 sizes of insulated boxes; The sides are multiples of 90 (3.54) mm (in.).
- Body made from polyester reinforced with fiberglass, molded by hot compression, 9 sizes.
- 3 types of cover available according to the sizes:
 - Standard cover, made from transparent polycarbonate with neoprene gasket, 45 (1.77) mm (in.) high, or 95 (3.74) mm (in.) high (final index A) according to the sizes,
 - Opaque polycarbonate cover (index C), with neoprene gasket, 45 (1.77) mm (in.) high, or 95 (3.74) mm (in.) high (final index A) according to the sizes,
 - Polyester reinforced with fiberglass cover (index P) with PUR gasket, 45 (1.77) mm (in.) high.
- Complete box includes body, cover, locking screws and sealing device.
- The bodies (prefix F) and the covers (prefix T) are supplied separately as standard references. The separate covers are supplied without locking screws or sealing accessories.
- The PLS enclosures with transparent cover are also offered in sets; The reference refers to the complete set.
- Excellent resistance to corrosion; withstands most chemical substances.
- Full insulation to create Class II assemblies.
- Standard lock with slot screws outside the volume of the boxes. Delivered with sealing system.
- External wall-mounted by 4 lugs, to be ordered separately.
- Service temperature: -40°C (-40°F) to 80°C (176°F)
- Bosses with M6 inserts for fixing the mounting plate.
- Halogen-free and compliant with the RoHS directive.

Color	RAL 7035 grey (opaque bodies and cover)
Ingress protection rating	IP66
Mechanical protection rating	IK09
Certifications	<ul style="list-style-type: none"> • Certification according to standard IEC 62208 to ensure compliance with IP, IK, resistance to heat and fire (self-extinguishing), insulation to 5000 V, and load of the mounting plate, 100 (220.46) kg (lbs.)/m² • UL508A* CAN/CSA-C22.2 - Types 1, 2, 3, 3R, 3S, 4, 4X, 12 and 13
Installation	Outdoor installation: Compliant with IEC 62208 regarding type tests specified in §9.12 (resistance to UV radiation) and §9.13 (resistance to corrosion). It is always advisable to install a canopy to avoid water stagnation on the top of the enclosure and to protect against UV radiation.
Options	-
Supply	-

* NSYPLS, NSYPLSP and NSYPLSC followed by suffixes.

Complete box



Dimensions			Transparent cover	Polycarbonate cover	Polyester cover
Height mm (in.)	Width mm (in.)	Depth mm (in.)	References	References	References
180 (7.09)	270 (10.63)	180 (7.09)	NSYPLS1827G	NSYPLSC1827G	NSYPLSP1827G
270 (10.63)	270 (10.63)	180 (7.09)	NSYPLS2727G	NSYPLSC2727G	NSYPLSP2727G
270 (10.63)	270 (10.63)	230 (9.06)	NSYPLS2727AG	NSYPLSC2727AG	-
270 (10.63)	360 (14.17)	180 (7.09)	NSYPLS2736G	NSYPLSC2736G	NSYPLSP2736G
270 (10.63)	360 (14.17)	230 (9.06)	NSYPLS2736AG	NSYPLSC2736AG	-
270 (10.63)	540 (21.26)	180 (7.09)	NSYPLS2754G	NSYPLSC2754G	NSYPLSP2754G
270 (10.63)	540 (21.26)	230 (9.06)	NSYPLS2754AG	NSYPLSC2754AG	-
360 (14.17)	270 (10.63)	180 (7.09)	-	-	-
360 (14.17)	360 (14.17)	180 (7.09)	NSYPLS3636G	NSYPLSC3636G	NSYPLSP3636G
360 (14.17)	540 (21.26)	180 (7.09)	NSYPLS3654G	NSYPLSC3654G	NSYPLSP3654G
360 (14.17)	540 (21.26)	230 (9.06)	NSYPLS3654AG	NSYPLSC3654AG	-
360 (14.17)	720 (28.35)	230 (9.06)	NSYPLS3672AG	NSYPLSC3672AG	-
540 (21.26)	270 (10.63)	180 (7.09)	-	-	-
540 (21.26)	540 (21.26)	180 (7.09)	NSYPLS5454G	NSYPLSC5454G	NSYPLSP5454G
540 (21.26)	540 (21.26)	230 (9.06)	NSYPLS5454AG	NSYPLSC5454AG	-
540 (21.26)	720 (28.35)	230 (9.06)	NSYPLS5472AG	NSYPLSC5472AG	-







7

Rear

Low covers: 45 (1.77) mm (in.)



Dimensions			Rear 135 (5.32) mm (in.)	Transparent	Polycarbonate	Polyester
Height mm (in.)	Width mm (in.)	Depth mm (in.)	References	References	References	References
180 (7.09)	270 (10.63)	180 (7.09)	NSYFPLS1827G	NSYTPLS1827	NSYTPLSC1827G	NSYTPLSP1827G
270 (10.63)	270 (10.63)	180 (7.09)	NSYFPLS2727G	NSYTPLS2727	NSYTPLSC2727G	NSYTPLSP2727G
270 (10.63)	270 (10.63)	230 (9.06)	NSYFPLS2727AG	-	-	-
270 (10.63)	360 (14.17)	180 (7.09)	NSYFPLS2736G	NSYTPLS2736	NSYTPLSC2736G	NSYTPLSP2736G
270 (10.63)	360 (14.17)	230 (9.06)	NSYFPLS2736AG	-	-	-
270 (10.63)	540 (21.26)	180 (7.09)	NSYFPLS2754G	NSYTPLS2754	NSYTPLSC2754G	NSYTPLSP2754G
270 (10.63)	540 (21.26)	230 (9.06)	NSYFPLS2754AG	-	-	-
360 (14.17)	360 (14.17)	180 (7.09)	NSYFPLS3636G	NSYTPLS3636	NSYTPLSC3636G	NSYTPLSP3636G
360 (14.17)	540 (21.26)	180 (7.09)	NSYFPLS3654G	NSYTPLS3654	NSYTPLSC3654G	NSYTPLSP3654G
360 (14.17)	540 (21.26)	230 (9.06)	NSYFPLS3654AG	-	-	-
360 (14.17)	720 (28.35)	230 (9.06)	NSYFPLS3672G	-	-	-
540 (21.26)	540 (21.26)	180 (7.09)	NSYFPLS5454G	NSYTPLS5454	NSYTPLSC5454G	NSYTPLSP5454G
540 (21.26)	540 (21.26)	230 (9.06)	NSYFPLS5454AG	-	-	-
540 (21.26)	720 (28.35)	230 (9.06)	NSYFPLS5472G	-	-	-

High covers: 95 (3.74) mm (in.)		Metal mounting plates		Insulated mounting plates	
					
Transparent	Opaque	Plain	Telequick	Polyester	Bakelite
References	References	References	References	References	References
-	-	NSYPMM1827	NSYPMR1827	NSYPMA1827G	NSYPMB1827
-	-	NSYPMM2727	NSYPMR2727	NSYPMA2727G	NSYPMB2727
NSYTPLS2727A	NSYTPLSC2727AG	NSYPMM2727	NSYPMR2727	NSYPMA2727G	NSYPMB2727
-	-	NSYPMM2736	NSYPMR2736	NSYPMA2736G	NSYPMB2736
NSYTPLS2736A	NSYTPLSC2736AG	NSYPMM2736	NSYPMR2736	NSYPMA2736G	NSYPMB2736
-	-	NSYPMM2754	NSYPMR2754	NSYPMA2754G	NSYPMB2754
NSYTPLS2754A	NSYTPLSC2754AG	NSYPMM2754	NSYPMR2754	NSYPMA2754G	NSYPMB2754
-	-	NSYPMM3636	-	NSYPMA3636G	NSYPMB3636
-	-	NSYPMM3654	NSYPMR3654	NSYPMA3654G	NSYPMB3654
NSYTPLS3654A	NSYTPLSC3654AG	NSYPMM3654	NSYPMR3654	NSYPMA3654G	NSYPMB3654
NSYTPLS3672A	NSYTPLSC3672AG	NSYPMM3672	NSYPMR3672	NSYPMA3672G	NSYPMB3672
-	-	NSYPMM5454	NSYPMR5454	NSYPMA5454G	NSYPMB5454
NSYTPLS5454A	NSYTPLSC5454AG	NSYPMM5454	NSYPMR5454	NSYPMA5454G	NSYPMB5454
NSYTPLS5472A	NSYTPLSC5472AG	NSYPMM5472	NSYPMR5472	NSYPMA5472G	NSYPMB5472

Technical changes reserved. Information provided without guarantee. Images are for illustrative purposes only.

Wall fixing lugs



NSYPF27N

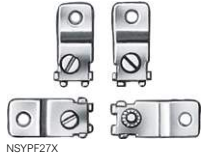

NSYPF27X

- Passivated zinc-coated steel
- Stainless-steel

Supply:
Set of 4 lugs and fixings

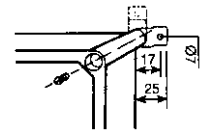

Characteristics	References
Wall fixing lug, passivated zinc-coated steel	NSYPF27N
Wall fixing lug, stainless-steel	NSYPF27X

Plastic carrying handle



NSYATM27

- Material: Plastic
- Ingress protection rating: IP43

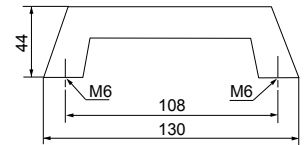

Characteristics	References
Plastic carrying handle	NSYATM27

Coupling frames



NSYUM27180

- Ingress protection rating: Frame with full opening: IP65 between enclosures

Characteristics	For surfaces mm (in.)	Opening mm (in.)	References
Full-opening frame	180 (7.09)	110 (4.33)	NSYUM27180
Full-opening frame	270 (10.63)	200 (7.87)	NSYUM27270
Full-opening frame	360 (14.17)	290 (11.42)	NSYUM27360

Comment:

Use the dimensional drawings of the boxes to identify which coupling frame you need. Consider the sides and surfaces you will join. Not UL-certified.

Comment:

Use the dimensional drawings of the boxes to identify which coupling frame you need. Consider the sides and surfaces you will join. Not UL-certified.

Supply:

References by unit. Order by multiples of 10 units (10, 20, 30, etc.).



NSYUCC270

- Ingress protection rating: Frame with full opening: IP44 between enclosures

Characteristics	For surfaces mm (in.)	Opening mm (in.)	References
Partial-opening frame	270 (10.63)	200 (7.87)	NSYUCC270
Partial-opening frame	360 (14.17)	290 (11.42)	NSYUCC360

Side plates



NSYTL27270G

- Ingress protection rating: IP65

Characteristics	For surfaces mm (in.)	Width mm (in.)	References
Side plate	270 (10.63)	200 (7.87)	NSYTL27270G
Side plate	360 (14.17)	290 (11.42)	NSYTL27360G

Box coupling unit piece



NSYPS2C27

- For coupling 2, 3 or 4 boxes, with optional wall-mounted.
- M6 x 8 (0.32) mm (in.) screw with cylindrical head.

Characteristics	References
Box coupling unit piece for coupling 2 boxes	NSYPS2C27
Box coupling unit piece for coupling 3 or 4 boxes	NSYPS4C27

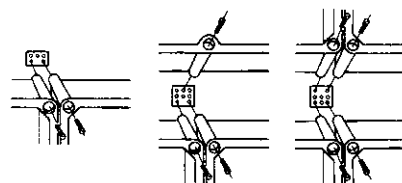

Supply:

To be ordered in multiples of 25



Locking systems for PLS boxes

- Slotted screw: Included in the standard references of boxes **NSYPLS●●●●**.
- Wing screw: Included in the standard references of modular distribution boxes **NSYPLS●●●●DLS●●●●**.
- Triangular screw: **NSYLT27**

Supply:
Set of 4, 6 or 8 screws.
The references also include 4 M6 screws for fixing mounting plates and 2 steel sealing accessories



NSYTCD274



NSYTCM274



NSYTCT274

Characteristics	Tool	References
Set of 4 slotted screws	Flat-blade screwdriver	NSYTCD274
Set of 6 slotted screws	Flat-blade screwdriver	NSYTCD276
Set of 8 slotted screws	Flat-blade screwdriver	NSYTCD278
Set of 4 wing screws	Manual	NSYTCM274
Set of 4 triangular screws	Triangular key	NSYTCT274

Closing locks



NSYCL27M

- Option of installing a side lock on the opposite side to where the hinges are installed
- Ingress protection rating: IP43

Characteristics	Tool	References
Double-bar side lock and handle	NSYDBP	NSYCL27M
Side lock with key 405	Key 405	NSYCL27L405



NSYCL27L405

Closing and opening



NSYLT27

Characteristics	References
Triangular key for PLS	NSYLT27

External hinges



NSYBE27G

- To open the door to 180°.
- Material: Plastic

Characteristics

External hinges, plastic

Comment:

IP level cannot be guaranteed due to type of application and installation

Supply:

Set of 2 hinges

References

NSYBE27G

Internal hinges



NSYBL27

- To open the door to 180°.
- Material: Brass

Characteristics

Internal hinges, brass

Comment:

IP level cannot be guaranteed due to type of application and installation

Supply:

Set of 2 hinges

References

NSYBL27

Insulated Industrial Boxes

Box of 164 (6.46) x 121 (4.76) x 87 (3.42) mm (in.) (external dimensions) **NSYTB●●●16128**

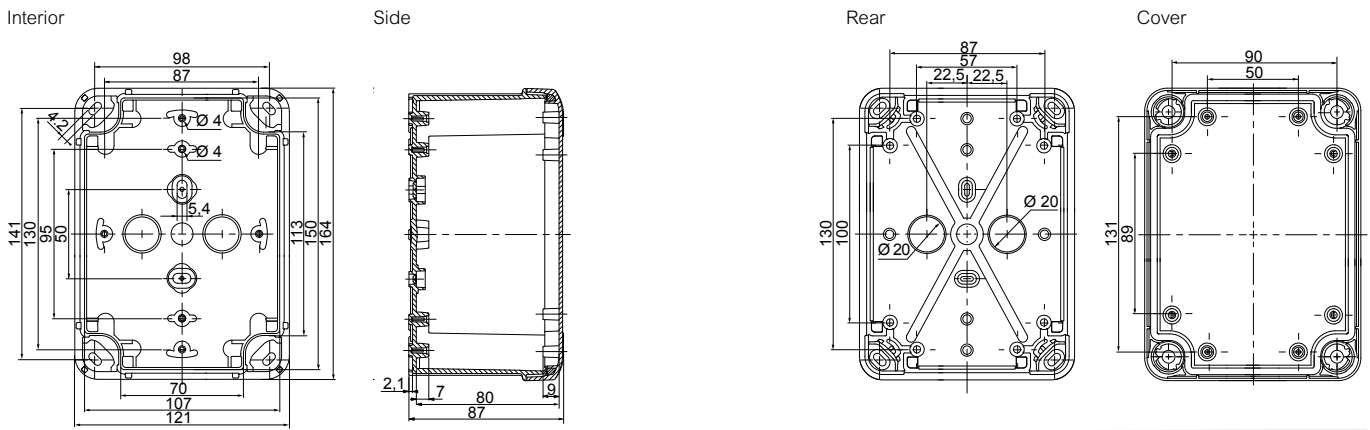

Box of 192 (7.56) x 121 (4.76) x 87 (3.42) or 105 (4.13) mm (in.) (external dimensions) **NSYTB●●●19128** or **NSYTB●●●191210**

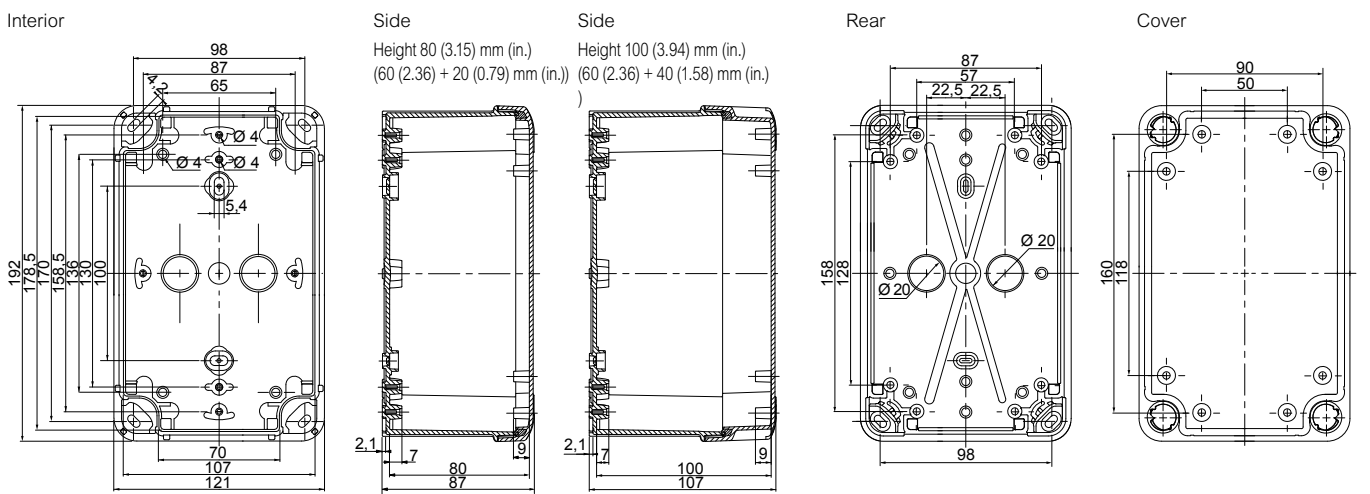

Box of 192 (7.56) x 164 (6.46) x 87 (3.42) or 105 (4.13) mm (in.) (external dimensions) **NSYTB●●●19168** or **NSYTB●●●191610**

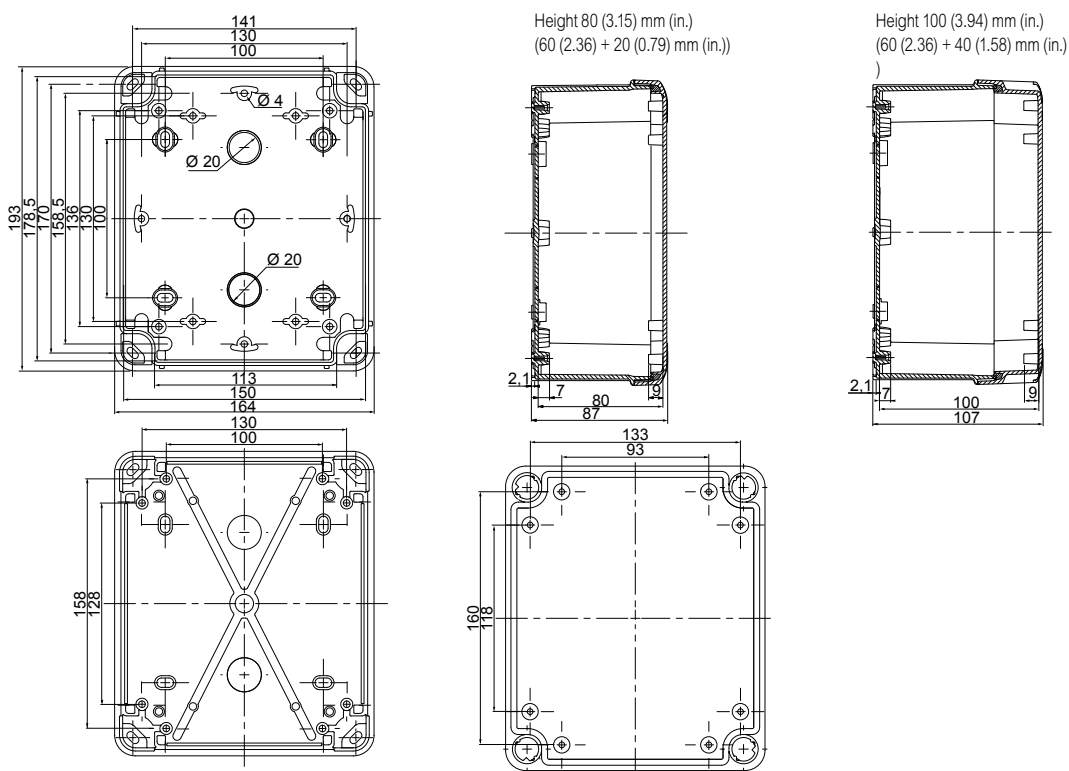

Box of 241 (9.49) x 194 (7.64) x 87 (3.42), 107 (4.21) or 127 (5.00) mm (in.) (external dimensions)
NSYTB●●●24198, NSYTB●●●241910 or NSYTB●●●241912

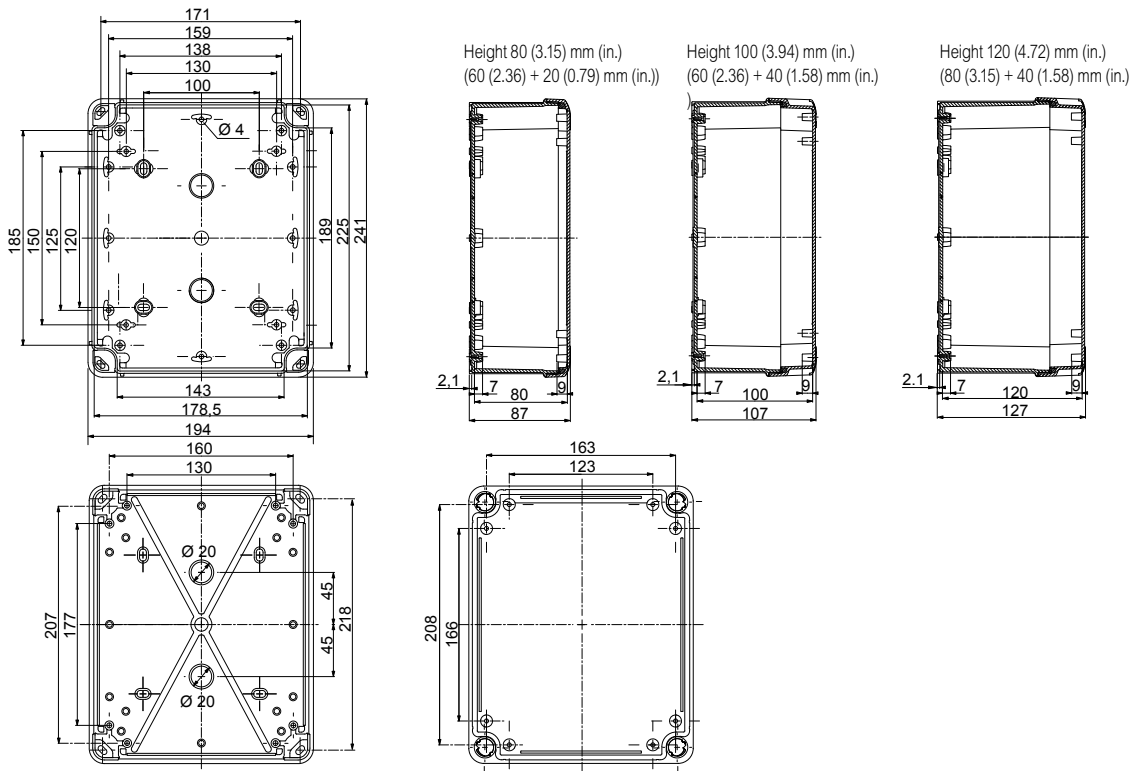

Box of 291 (11.46) x 241 (9.49) x 88 (3.46), 128 (5.04) or 168 (6.61) mm (in.) (external dimensions)
NSYTB●●●29248, NSYTB●●●292412 or NSYTB●●●292416

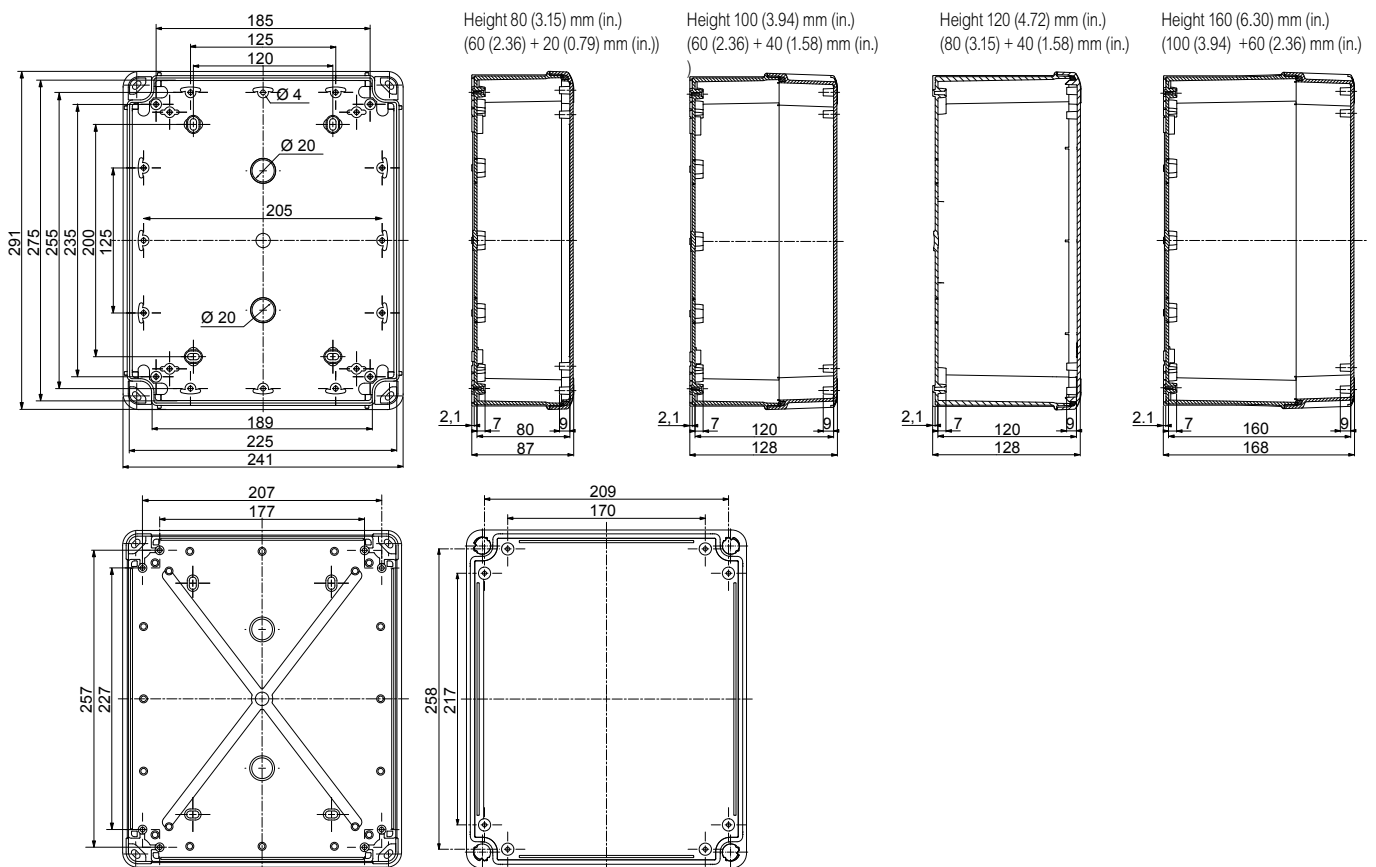

Technical changes reserved. Information provided without guarantee. Images are for illustrative purposes only.

Insulated Industrial Boxes

Box of 341 (13.42) x 291 (11.46) x 128 (5.04) or 168 (6.61) mm (in.) (external dimensions)
NSYTB●●●342912 or **NSYTB●●●342916**

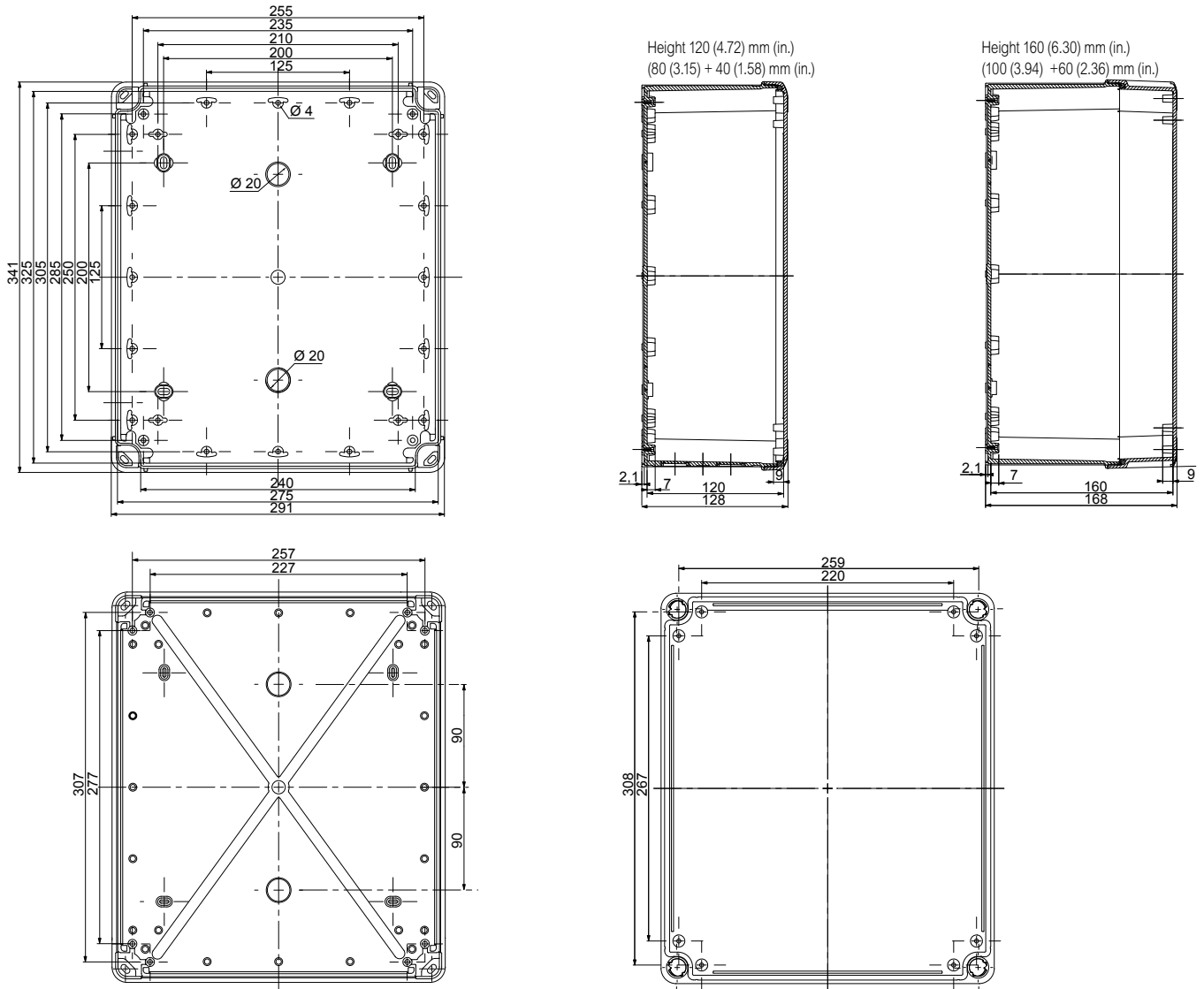

Technical changes reserved. Information provided without guarantee. Images are for illustrative purposes only.

NSYPLS●●●1827G

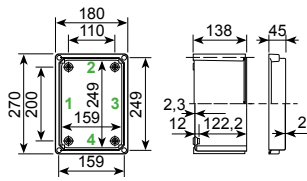

NSYPLS●●●2727●G

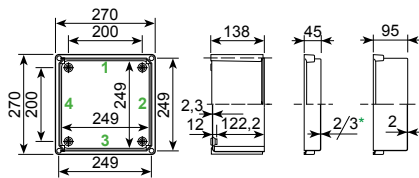

NSYPLS●●●2736●G

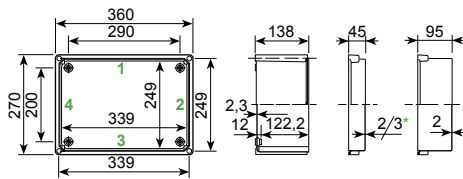

NSYPLS●●●3636G

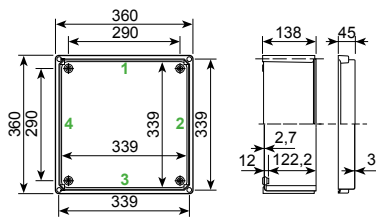

NSYPLS●●●2754●G

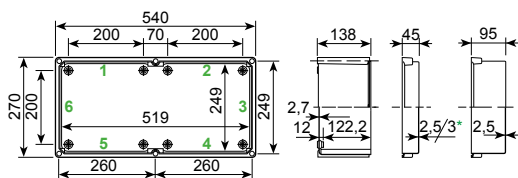

NSYPLS●●●3654●G

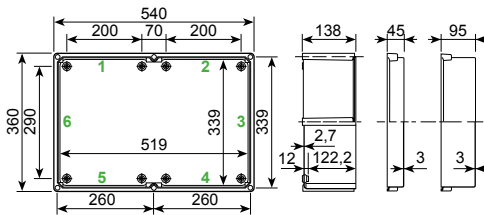

NSYPLS●●●5454●G

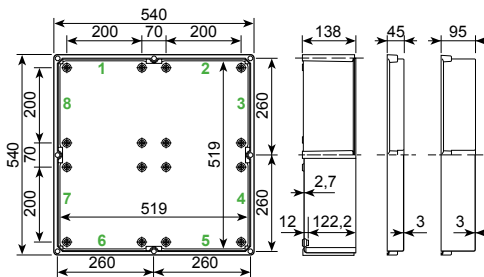

NSYPLS●●●3672●G

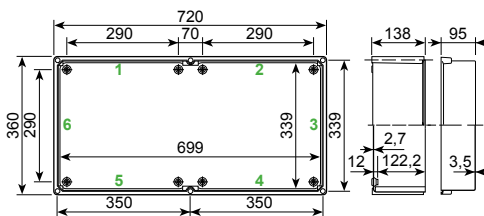

NSYPLS●●●5472●G

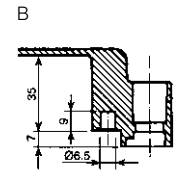
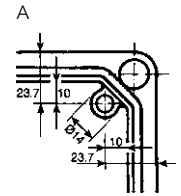
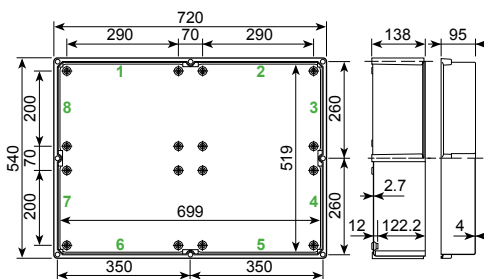

A - B: Internal view of the corners of the polyester covers with bosses for inserts ref. **NSYTEX5** for M5 screws.

* Thickness of 30/10° mm for the polyester cover.

Examples of assembly

All the boxes can be joined by their lateral surfaces using the coupling frames **NSYUM●●●** or **NSYUCC●●●**, and the joining and fixing pieces **NSYPS2C27** and **NSYPS4C27**.

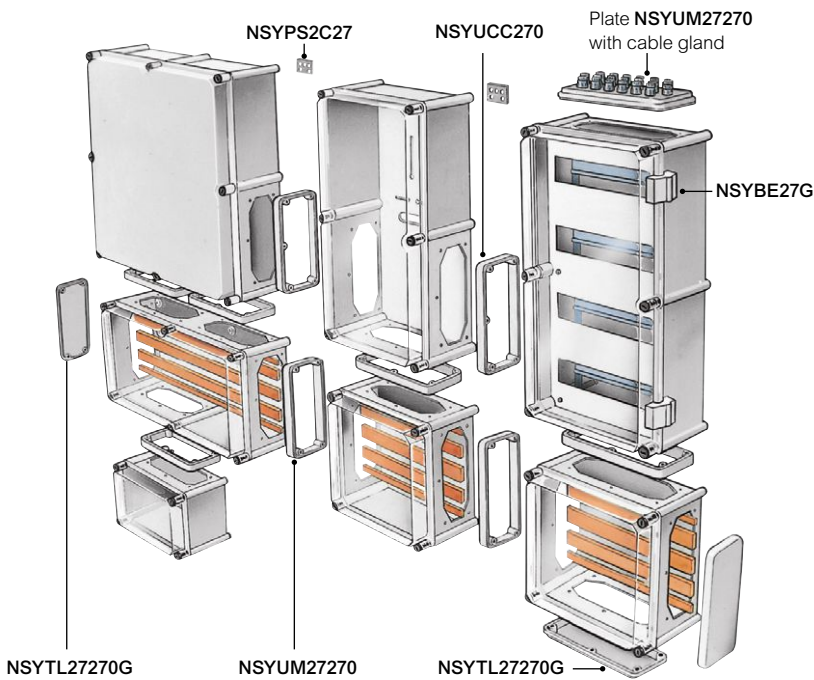
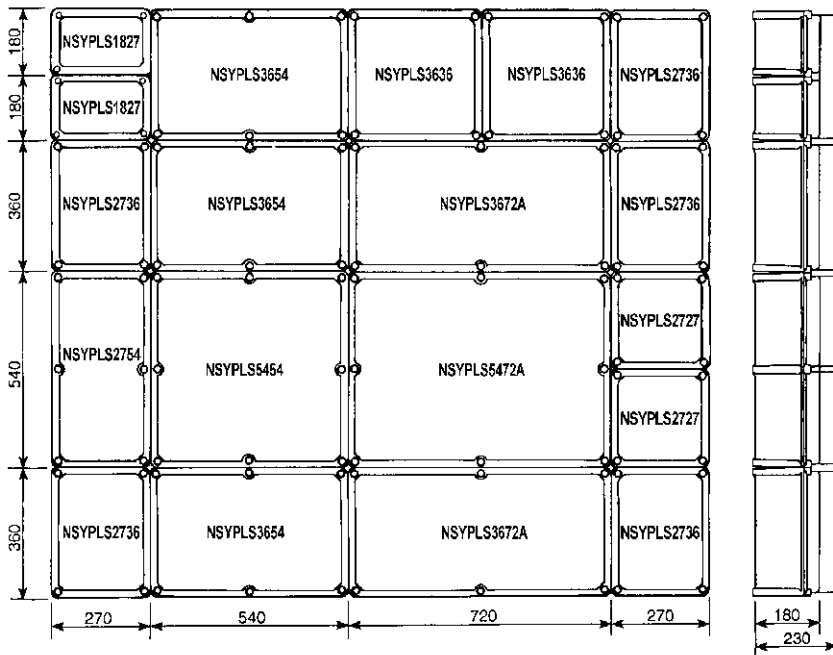

Insulated Wall-Mounted Enclosures

Polyester wall-mounted enclosures



Thalassa PLM



Introduction	198
Characteristics	199
Selection guide	200
Specific accessories	201
Dimensions	210

Monobloc wall-mounted enclosure, made of polyester reinforced with fiberglass, molded by hot compression. Degree of protection IP66, impact resistance IK10 for plain doors and surfaces, and IK08 for glazed doors of polyester versions, UL certification (cULus), rating according to UL50E 4x and 13 for polyester wall-mounted enclosures. Full insulation to produce Class II-units compliant with RoHS and REACH directives



8



Easy installation

- Door easily reversible by turning it over.
- Opening to 120° or 180°.
- Easy machining with no corrosion.
- Lightness.
- Polyamide hinge pin, easily removable and captive.



Service life

- High resistance to corrosion in harsh environments, maintaining mechanical properties and insulation.



Smart interior

- Notches for easy fixing of DIN rails.
- Grid pattern on the rear of the door for marking the machining operations.



Landscape enclosures

- Horizontal enclosures for photovoltaic and multiple applications
- Easily and quickly removable door system (without removing hinges and pins)
- For more details see [page 338](#)

For details consult our web site www.se.com

 Prolonged exposure to UV radiation, wind and rain can cause aesthetics changes in the external surface of the enclosure. Without affecting the technical properties according to IEC 62208. For long exposure applications, it is recommended to use painted enclosures available through the P&S offer.



Class II













Characteristics	ABS/PC wall-mounted enclosures	Polyester wall-mounted enclosures	
	<ul style="list-style-type: none"> • Monobloc wall-mounted enclosure. • Version with transparent polycarbonate door. • Door opening: 180°. • Supplied with a lock with double-bar insert as standard 	<ul style="list-style-type: none"> • Monobloc wall-mounted enclosure. • Version with transparent tempered-glass door. • Door opening angle: 120°. • Grid pattern with a pitch of 50 (1.97) mm (in.) on the back of the door. • Supplied with one lock with a double-bar insert as standard. 	<ul style="list-style-type: none"> • Monobloc wall-mounted enclosure. • Version with transparent tempered-glass door. • Locking device outside the sealed area to ensure long-term tightness according to IP66. • Locking system: enclosure height ≤ 847 (33.35) mm (in.): 2 locks with double-bar insert ref. NSYCDBPLM or 1 handle with key lock and 3-point locking system, enclosure height 1056 (41.58) mm (in.): 1 lock with double-bar insert and 4-point locking system ref. NSYVPLM108. • Door opening angle: 180°. • Bosses for accessory-fixing inserts: M6 inside the enclosure, M5 in the door for enclosure heights of 430 (16.93) and 530 (20.87) mm (in.), M6 in the door for enclosure heights ≥ 647 (25.47) mm (in.) • Grid pattern with a pitch of 25 (0.98) mm (in.) on the back of the door.
Material	ABS/PC	Polyester reinforced with fiberglass, molded by hot compression	
Temperature range - Gasket	-40°C (-40°F) to 80°C (176°F)		
Color	RAL 7035 grey		
Ingress protection rating	IP66 according to IEC 60529		
Mechanical protection rating	<ul style="list-style-type: none"> • IK10 plain door • IK08 glazed door 		
Certifications (see page 506)	<ul style="list-style-type: none"> • IEC 62208 • Bureau Veritas Marine 	<ul style="list-style-type: none"> • IEC 62208 • Marine • UL 508A - NEMA type: 1, 2, 3, 3R, 3S, 4, 4X, 5, 12 and 13 	<ul style="list-style-type: none"> • IEC 62208 • Marine
Installation	<ul style="list-style-type: none"> • Direct fixing of symmetrical rails ref. NSYCS200PLM with plastic nuts ref. NSYTCSPML, to be installed in the notches on the rear of the body, with a pitch of 25 (0.98) mm (in.) • Fixing of installation plates on the studs at the rear of the enclosure 	<ul style="list-style-type: none"> • Fixing of rear accessories on 4 M8 x 18 studs 	<ul style="list-style-type: none"> • Fixing of rear accessories on 4 M8 studs, included in the standard supply • Direct fixing of symmetrical rails ref. NSYCS●●●PLM, with plastic nuts, ref. NSYTCSPML, to be installed in the notches on the rear of the body, with a pitch of 25 (0.98) mm (in.)

External dimensions			References of wall-mounted enclosures with door							
Height mm (in.)	Width mm (in.)	Depth mm (in.)	Plain (3)	Transparent (4)	Plain (3)	Transparent (4)	Plain (3)	Transparent (4)	Plain (1)	Transparent (1) (4)
308 (12.13)	255 (10.04)	160 (6.30)	-	-	NSYPLM3025G	NSYPLM3025TG	-	-	-	-
310 (12.20)	215 (8.46)	160 (6.30)	NSYPLM32G	NSYPLM32TG	-	-	-	-	-	-
430 (16.93)	330 (12.99)	200 (7.87)	-	-	-	-	NSYPLM43G	NSYPLM43TG	NSYPLM43VG	NSYPLM43TVG
530 (20.87)	430 (16.93)	200 (7.87)	-	-	-	-	NSYPLM54G	NSYPLM54TG	NSYPLM54VG	NSYPLM54TVG
647 (25.47)	436 (17.16)	250 (9.84)	-	-	-	-	NSYPLM64G	NSYPLM64TG	NSYPLM64VG	NSYPLM64TVG
747 (29.41)	536 (21.10)	300 (11.81)	-	-	-	-	NSYPLM75G	NSYPLM75TG	NSYPLM75VG	NSYPLM75TVG
847 (33.35)	636 (25.04)	300 (11.81)	-	-	-	-	NSYPLM86G	NSYPLM86TG	NSYPLM86VG	NSYPLM86TVG
1056 (41.58)	852 (33.54)	350 (13.78)	-	-	-	-	NSYPLM108G (2)	NSYPLM108TG (2)	-	-





(1) Wall-mounted enclosure with handle and lock with 3-point locking system and key 1242 E delivered as standard.
 (2) Wall-mounted enclosure with standard 5 (0.20) mm (in.) double-bar lock and lock with 4-point locking system.
 (3) These enclosures are also available equipped with metal or insulated mounted plates.
 (4) Must be protected against UV radiation.



Comment:
 For air shipments of **NSYPLM108G**, the reference **NSYPLMRS108GA** must be ordered

ABS/PC wall-mounted enclosures with door			Polyester wall-mounted enclosures with door			
Comment: For dimensions see page 210						
			Plain (3)	Transparent (4)	Plain (3)	Transparent (4)
External dimensions			References	References	References	References
Height mm (in.)	Width mm (in.)	Depth mm (in.)				
310 (12.20)	215 (8.46)	160 (6.30)	NSYPLM32G	NSYPLM32TG	-	-
308 (12.13)	255 (10.04)	160 (6.30)	-	-	NSYPLM3025G	NSYPLM3025TG

Polyester wall-mounted enclosures with door												
Comment: For dimensions see page 210												
							Plain (3)	NSYPLM108G	Transparent (4)	NSYPLM108TG	Plain (1)	Transparent (1) (4)
External dimensions												
Height mm (in.)	Width mm (in.)	Depth mm (in.)	References	References	References	References						
430 (16.93)	330 (12.99)	200 (7.87)	NSYPLM43G	NSYPLM43TG	NSYPLM43VG	NSYPLM43TVG						
530 (20.87)	430 (16.93)	200 (7.87)	NSYPLM54G	NSYPLM54TG	NSYPLM54VG	NSYPLM54TVG						
647 (25.47)	436 (17.16)	250 (9.84)	NSYPLM64G	NSYPLM64TG	NSYPLM64VG	NSYPLM64TVG						
747 (29.41)	536 (21.10)	300 (11.81)	NSYPLM75G	NSYPLM75TG	NSYPLM75VG	NSYPLM75TVG						
847 (33.35)	636 (25.04)	300 (11.81)	NSYPLM86G	NSYPLM86TG	NSYPLM86VG	NSYPLM86TVG						
1056 (41.58)	852 (33.54)	350 (13.78)	NSYPLM108G (2)	NSYPLM108TG (2)	-	-						

- (1) Wall-mounted enclosure with handle and lock with 3-point locking system and key 1242 E delivered as standard.
- (2) Wall-mounted enclosure with standard 5 (0.20) mm (in.) double-bar lock and lock with 4-point locking system.
- (3) These enclosures are also available equipped with metal or insulated mounted plates.
- (4) Must be protected against UV radiation.

Wall-mounted enclosures with plain door and mounted plate (not mounted)										
Comment: For dimensions see page 210										
							Plain	Bakelite	Plain	Bakelite
External dimensions										
Height mm (in.)	Width mm (in.)	Depth mm (in.)	References	References	References	References				
310 (12.20)	215 (8.46)	160 (6.30)	NSYPLM32PG	NSYPLM32BG	-	-				
308 (12.13)	255 (10.04)	160 (6.30)	-	-	NSYPLM3025PG	NSYPLM3025BG				

Wall-mounted enclosures with plain door and mounted plate (not mounted)									
Comment: For dimensions see page 210									
							Plain	Bakelite	NSYPLM108BG
External dimensions									
Height mm (in.)	Width mm (in.)	Depth mm (in.)	References	References	References	References			
430 (16.93)	330 (12.99)	200 (7.87)	NSYPLM43PG	NSYPLM43BG					
530 (20.87)	430 (16.93)	200 (7.87)	NSYPLM54PG	NSYPLM54BG					
647 (25.47)	436 (17.16)	250 (9.84)	NSYPLM64PG	NSYPLM64BG					
747 (29.41)	536 (21.10)	300 (11.81)	NSYPLM75PG	NSYPLM75BG					
847 (33.35)	636 (25.04)	300 (11.81)	NSYPLM86PG	NSYPLM86BG					
1056 (41.58)	852 (33.54)	350 (13.78)	-	NSYPLM108BG					

Technical changes reserved. Information provided without guarantee. Images are for illustrative purposes only.



Characteristics	ZM plinth for PLM enclosure <ul style="list-style-type: none"> Designed to support and raise enclosures NSYPLM75G, NSYPLM86G and NSYPLM108G. Plinth height of 200 (7.87) mm (in.); stackable to obtain a 400 (15.75) mm (in.) plinth. Four floor attachment points; The symmetry of the parts prevents incorrect assembly. <p>The front parts of the plinth (front and rear) have two stainless-steel screws protected by a plastic cap; these screws make it possible (using an Allen key) to open and remove the front parts for easier cable installation. In stacked position, the bottom plinth can be partially buried. It is provided with one transverse reinforcement rail, adjustable to adapt to the position of the cables. The reference of the plinth contains all the accessories required for attaching the enclosure to the plinth and for stacking two plinths.</p>
Material	Polyester reinforced with fiberglass, molded by hot compression
Ingress protection rating	IP44
Mechanical protection rating	IK10
Standards	Helps guarantee full insulation according to IEC 61439-1

Plinth



NSYZM253G

Characteristics	PLM enclosure	Height mm (in.)	Width mm (in.)	Depth mm (in.)	Reference
Plinth	NSYPLM75G	200 (7.87)	456 (17.95)	302 (11.89)	NSYZM253G
Plinth	NSYPLM86G	200 (7.87)	556 (21.89)	302 (11.89)	NSYZM263G
Plinth	NSYPLM108G	200 (7.87)	772 (30.39)	352 (13.86)	NSYZM283G



Cable supporting cross-rail

The sides of the plinths are provided with bosses for the attachment of cross-rails with cut-out profiles that support the cables. The reference of the cross-rail includes all elements required for assembly.



NSYAC280

Characteristics	For plinth	Reference
Cable supporting cross-rail	NSYZM253G	NSYAC280
Cable supporting cross-rail	NSYZM263G	NSYAC360
Cable supporting cross-rail	NSYZM283G	NSYAC600

Kit for IP54



NSYAEFZM

Required to obtain IP54 for the plinth and the plinth enclosure coupling.

Characteristics	Reference
Kit for IP54	NSYAEFZM

Feet for partially buried installation



NSYAEFZ

Allows the partially buried installation of plinths before completion of the floor. The plinths are attached by four feet with a standard length of 750 (29.53) mm (in.). Possibility of horizontal adjustment of the plinth. The reference includes a kit made up of four feet and fixings.

Characteristics	Reference
Feet for partially buried installation	NSYAEFZ

Floor-mounted pillar

To protect cables entering the enclosure in outdoor installations.
Cable entry section: 165 (6.50) x 100 (3.94) mm (in.).
For enclosures ref. **NSYPLM54G**, **NSYPLM54TG**, **NSYPLM64G** and **NSYPLM64TG**.



NSYSFSPLMG

- Material: Polyester reinforced with fiberglass
- Color: RAL 7035 grey

Supply:
Delivered with steel frame for secure fixing to the floor

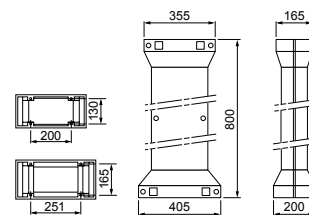

Characteristics	Reference
Floor-mounted pillar	NSYSFSPLMG

Wall fixing lugs

Set of 4 wall fixing lugs. Mounted directly on the enclosure, either in horizontal position or in vertical position.

- Material: Polyamide reinforced with fiberglass
- Color: RAL 7035 grey
- **Maximum load:**
On PLM32: Vertical or horizontal: 10 (22.05) kg (lbs.)
Other PLM models: Vertical position: 200 (440.92) kg (lbs.), horizontal position: 100 (220.46) kg (lbs.)

Supply:
Delivered with fixings



NSYFPFLMG

NSYFPFLM32G

Characteristics	Reference
Wall fixing lugs	NSYFPFLMG
Wall fixing lugs, exclusively for enclosures ref. NSYPLM32G and NSYPLM32TG.	NSYFPFLM32G

Wall fixing lugs

Set of 4 wall fixing lugs. Mounted directly on the enclosure, either in horizontal position or in vertical position.

- Material: Stainless-steel
- Color: RAL 7035 grey
- **Maximum load:**
Other PLM models: Vertical position: 200 (440.92) kg (lbs.), horizontal position: 100 (220.46) kg (lbs.)

Supply:
Delivered with fixings



NSYFPXPLM

Characteristics	Reference
Wall fixing lugs	NSYFPXPLM

Post fixing device



NSYSFP300

- For outdoor installations on a post with a maximum circumference of 675 (26.58) mm (in.), Ø 215 (8.46) mm (in.).
- Material: Galvanized steel
- Maximum load: 100 (220.46) kg (lbs.)

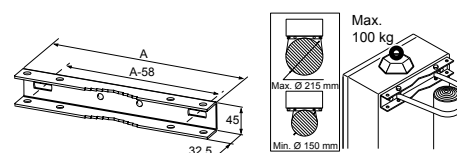

Supply:
Supply of 2 rails, the strips and the fixings

Characteristics	For wall-mounted enclosure	Reference
Post fixing device	NSYPLM43G	NSYSFP300
Post fixing device	NSYPLM54G and NSYPLM64G	NSYSFP400
Post fixing device	NSYPLM75G	NSYSFP500
Post fixing device	NSYPLM86G	NSYSFP600

Blanking plates

Aesthetic Accessory. They are positioned on the rear surface of the enclosures to block the openings in the corners in order to improve their appearance or prevent the entry of unwanted elements in the airing shaft. Supplied as standard for enclosure, ref. **NSYPLM108G**.

- Material: Thermoplastic
- Color: RAL 7035 grey
- Ingress protection rating: IP40

Accessory is mounted outside the IP66-protected area.



NSYCEPLMAG

Characteristics	For wall-mounted enclosure	Reference
Blanking plates	NSYPLM32G	NSYCEPLMAG
Blanking plates	NSYPLM43G and NSYPLM54G	NSYCEPLMBG
Blanking plates	NSYPLM64G, 75G and 86G	NSYCEPLMCG

Support bracket for enclosure with anti-tilt kit and reinforcement



NSYCOCONS1400

- The support bracket is used when the enclosure cannot be hung from a wall or a post.
- Maximum enclosure dimensions: 1000 (39.37) x 800 (31.50) x 300 (11.81) mm (in.).
- Floor attachment by standard M12 fasteners.
- Material: Steel
- Finish: Epoxy polyester paint
- Color: RAL 7035 grey
- Maximum load: 120 (264.55) kg (lbs.)

Characteristics	Height mm (in.)	References
Support bracket for enclosure with anti-tilt kit and reinforcement	1400 (55.12)	NSYCOCONS1400
Support bracket for enclosure with anti-tilt kit and reinforcement	1800 (70.87)	NSYCOCONS1800

Internal door

- Reversible door.
- Grid pattern with a pitch of 25 (0.98) mm (in.) for easier marking before drilling.
- Closes with 2 double-bar locks.
- Door handle.
- Steel internal door, without grid pattern and locking by a screw, for enclosures ref. **NSYPLM3025G**.
- Incompatible with the modular distribution chassis.
- Material: Polyester reinforced with fiberglass, self-extinguishing
- Color: RAL 7035 grey

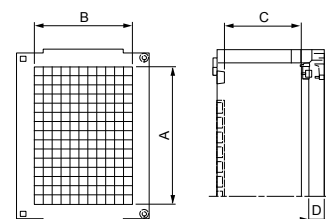

Supply:
Delivered with fixings and brass inserts



NSYPA3025PLMG

Characteristics	Height mm (in.)	Width mm (in.)	A mm (in.)	B mm (in.)	C mm (in.)	D Plain door mm (in.)	D Transp. door mm (in.)	Reference
Internal door	308 (12.13)	255 (10.04)	248 (9.76)	165 (6.50)	62 (2.44)	76 (2.99)	71 (2.80)	NSYPA3025PLMG
Internal door	430 (16.93)	330 (12.99)	315 (12.40)	205 (8.07)	152 (5.98)	26 (1.02)	21 (0.83)	NSYPAP43G
Internal door	530 (20.87)	430 (16.93)	415 (16.34)	305 (12.01)	152 (5.98)	26 (1.02)	21 (0.83)	NSYPAP54G
Internal door	645 (25.39)	435 (17.13)	515 (20.28)	305 (12.01)	194 (7.64)	32 (1.26)	27 (1.06)	NSYPAP64G
Internal door	745 (29.33)	535 (21.06)	615 (24.21)	405 (15.94)	244 (9.61)	32 (1.26)	27 (1.06)	NSYPAP75G
Internal door	845 (33.27)	635 (25.00)	715 (28.15)	505 (19.88)	244 (9.61)	32 (1.26)	27 (1.06)	NSYPAP86G
Internal door	1055 (41.54)	850 (33.46)	850 (33.46)	650 (25.59)	269 (10.59)	37 (1.46)	32 (1.26)	NSYPAP108G

New

PLM landscape (horizontal) range for photovoltaic and multiple applications with removable door system [see page 338](#)



Scan or click for video

Metal mounted plate



Characteristics	Plain	Silkscreened	Microperforated
-----------------	-------	--------------	-----------------

Model	Enclosure Dimensions			MP Dimension		Reference	Reference	Reference
	Height mm (in.)	Width mm (in.)	Depth mm (in.)	Height mm (in.)	Width mm (in.)			
NSYPLM32	310 (12.20)	215 (8.46)	160 (6.30)	250 (9.84)	150 (5.91)	NSYMM32	-	-
NSYPLM3025	308 (12.13)	255 (10.04)	160 (6.30)	250 (9.84)	200 (7.87)	NSYMM3025	-	-
NSYPLM43	430 (16.93)	330 (12.99)	200 (7.87)	230 (9.06)	350 (13.78)	NSYMM43	NSYMS43	NSYMF43
NSYPLM54	530 (20.87)	430 (16.93)	200 (7.87)	450 (17.72)	350 (13.78)	NSYMM54	NSYMS54	NSYMF54
NSYPLM64	647 (25.47)	436 (17.16)	250 (9.84)	550 (21.65)	350 (13.78)	NSYMM64	NSYMS64	NSYMF64
NSYPLM75	747 (29.41)	536 (21.10)	300 (11.81)	650 (25.59)	450 (17.72)	NSYMM75	NSYMS75	NSYMF75
NSYPLM86	847 (33.35)	636 (25.04)	300 (11.81)	750 (29.53)	550 (21.65)	NSYMM86	NSYMS86	NSYMF86
NSYPLM108	1056 (41.58)	852 (33.54)	350 (13.78)	950 (37.40)	750 (29.53)	NSYMM108	-	NSYMF108

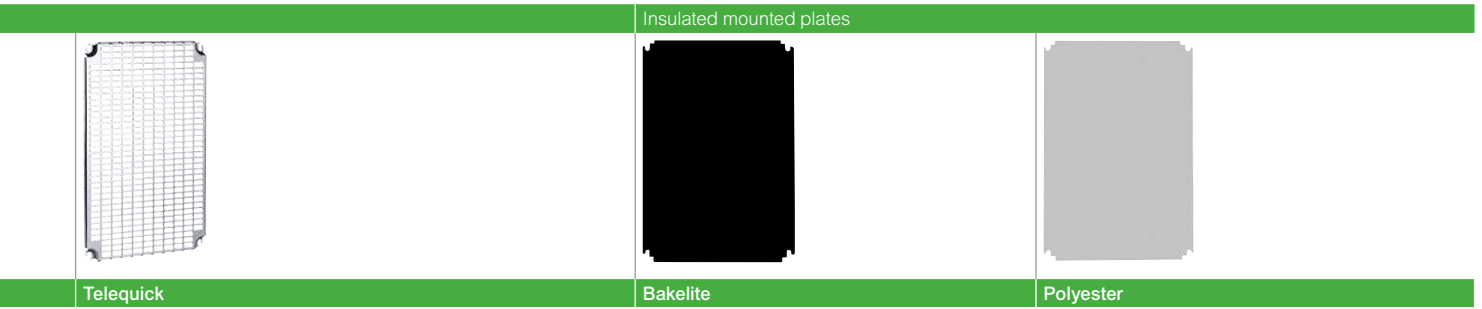

Height mm (in.)	Width mm (in.)	# of perforation H	# of perforation W	Reference	Height mm (in.)	Width mm (in.)	Thick. mm (in.)	Reference	Height mm (in.)	Width mm (in.)	Thick. mm (in.)	Reference
255 (10.04)	153.7 (6.05)	16	5	NSYMR32	265 (10.43)	150 (5.91)	4 (0.16)	NSYMB32	265 (10.43)	150 (5.91)	4 (0.16)	NSYMPP32
253 (9.96)	228 (8.98)	16	8	NSYMR3025	265 (10.43)	200 (7.87)	4 (0.16)	NSYMB3025	265 (10.43)	200 (7.87)	4 (0.16)	NSYMPP3025
348.7 (13.73)	251 (9.88)	22	9	NSYMR43	325 (12.80)	250 (9.84)	4 (0.16)	NSYMB43	325 (12.80)	250 (9.84)	4 (0.16)	NSYMPP43
450 (17.72)	351 (13.82)	31	11	NSYMR54	465 (18.31)	350 (13.78)	4 (0.16)	NSYMB54	465 (18.31)	350 (13.78)	4 (0.16)	NSYMPP54
555 (21.85)	351 (13.82)	38	11	NSYMR64	565 (22.24)	350 (13.78)	4 (0.16)	NSYMB64	565 (22.24)	350 (13.78)	4 (0.16)	NSYMPP64
645 (25.39)	451 (17.76)	44	14	NSYMR75	665 (26.18)	450 (17.72)	4 (0.16)	NSYMB75	665 (26.18)	450 (17.72)	4 (0.16)	NSYMPP75
750 (29.53)	551 (21.69)	51	17	NSYMR86	765 (30.12)	550 (21.65)	4 (0.16)	NSYMB86	765 (30.12)	550 (21.65)	5 (0.20)	NSYMPP86
945 (37.20)	751 (29.57)	64	24	NSYMR108	965 (37.99)	750 (29.53)	4 (0.16)	NSYMB108	965 (37.99)	750 (29.53)	5 (0.20)	NSYMPP108

Technical changes reserved. Information provided without guarantee. Images are for illustrative purposes only.

Options to convert the locks to double-bar inserts **NSYPLM32G** to **NSYPLM86G**



NSYTC8CRN



NSYTT8CRN



NSYTL405PLM

- Changing the shaped inserts for locks with keys according to the following table.

Characteristics	Operated with a key	References
Square insert 6 (0.24) mm (in.) □	LC-7	NSYTC6CRN
Square insert 7 (0.28) mm (in.) □	LC-7	NSYTC7CRN
Square insert 8 (0.32) mm (in.) □	LC-8	NSYTC8CRN
Triangular insert 6 (0.24) mm (in.) ▲	LT-8	NSYTT6CRN
Triangular insert 8 (0.32) mm (in.) ▲	LT-8	NSYTT8CRN
Lock and key 405		NSYTL405PLM
Lock and key 220		NSYTL220PLM
Lock TJIS		NSYTLJIS

Options to convert the locks to double-bar inserts **NSYPLM32G** to **NSYPLM86G**

- Replacement for locking handle with cylindrical barrel, delivered with all the parts required to change the lock.



NSYTHL1242EPLM

Characteristics	References
Key 1242 E	NSYTHL1242EPLM
Key 405	NSYTHL405PLM
Key 421	NSYTHL421PLM
Key 455	NSYTHL455PLM
Key 2331 A	NSYTHL2331APLM
Key 2433 A	NSYTHL2433APLM
Key 3113 A	NSYTHL3113APLM
Key 3131A	NSYTHL3131APLM
Manual	NSYTHPLM

Options to convert versions **NSYPLM●●V**, with retractable handle and 3-point locking system

- Conversion of the standard insert (barrel for key 1242E, ref. **NSYTL1242EME**) to other shaped inserts or barrels according to the following table.

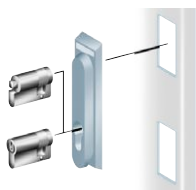

NSYTD5ME

Characteristics	References
5 (0.20) mm (in.) double-bar	NSYTD5ME
6 (0.24) mm (in.) male square	NSYTC6ME
8 (0.32) mm (in.) male square	NSYTC8ME
6.5 (0.26) mm (in.) male triangular	NSYTT6ME
8 (0.32) mm (in.) male triangular	NSYTT8ME
Barrel and key 405	NSYTCL405ME
Reinforced key and barrel	NSYTLRME
JIS key and barrel	NSYTLJISME
Manual	NSYTMME

Locks and inserts for enclosures **NSYPLM108/T**

- Options to convert the insert
- The standard insert can be replaced with other shaped inserts according to the following table.

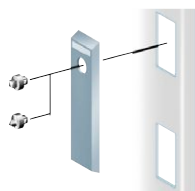

NSYTDB5PL

Characteristics	References
Double-bar insert	NSYTDB5PL

Locks and inserts for enclosures **NSYPLM108/T**

- Options to convert to a retractable handle
- The escutcheon and rosette assembly can be replaced with a lock with retractable handle equipped with inserts or barrels according to the following table.

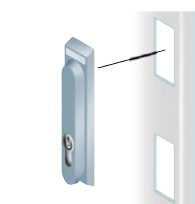

NSYTEDB5PL

Characteristics	References
5 (0.20) mm (in.) double-bar	NSYTEDB5PL
6 (0.24) mm (in.) male square	NSYTEC6PL
7 (0.28) mm (in.) male square	NSYTEC7PL
6.5 (0.26) mm (in.) male triangular	NSYTET6PL
8 (0.32) mm (in.) male triangular	NSYTET8PL
Lock key 1242 E	NSYTEL1242EPL
Barrel and key 405	NSYTEL405PL
Reinforced key and barrel	NSYTERPL
JIS key and barrel	NSYTELJISPL
FAC key and barrel	NSYTELFACPL
Manual	NSYTEMPL

Padlocking accessories

Padlocking system positioned around the rectangular escutcheon of the enclosures with a height of ≤ 847 (33.35) mm (in.) to block access to the lock; For a $\varnothing 9$ (0.35) mm (in.) padlock.



NSYKPLM

Characteristics	References
Padlocking accessories	NSYKPLM

Padlocking accessories

Padlocking system positioned around the long rectangular escutcheon of the enclosures ref. **NSYPLM108G/TG** to block access to the lock; For $\varnothing 9$ (0.35) mm (in.) padlock.



NSYBCPL

Characteristics	References
Padlocking accessories	NSYBCPL

Padlocking accessories

Padlocking system to block access to the retractable handle, for the versions **NSYPLM●●V** or optionally for enclosures ref. **NSYPLM108G/TG**, for a $\varnothing 9$ (0.35) mm (in.) padlock.



NSYBCME

Characteristics	References
Padlocking accessories	NSYBCME

Step slides

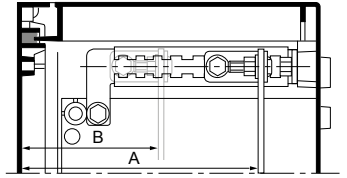

Kit allowing depth adjustment with a pitch of 12.5 (0.49) mm (in.), and the fixings required for the installation. Incompatible with the modular distribution chassis.

Supply:
4 step slides with brackets



NSYDPLM200

Characteristics (Material: Galvanized steel)	For wall-mounted enclosure depth mm (in.)	Depth adjustment A mm (in.)	Depth adjustment B mm (in.)	References
Step slides	200 (7.87)	156 (6.14)	94 (3.70)	NSYDPLM200
Step slides	250 (9.84)	200 (7.87)	100 (3.94)	NSYDPLM250
Step slides	300 (11.81)	250 (9.84)	100 (3.94)	NSYDPLM300
Step slides	350 (13.78)	306 (12.05)	106 (4.17)	NSYDPLM350

Plastic nuts for rail fixing

They slide directly into the notches, with a pitch of 25 (0.98) mm (in.), which are located on the rear of the enclosures, except enclosure ref. **NSYPLM3025G/TG**. They allow direct fixing of symmetrical DIN rails by self-tapping screws. Option of raising the rails with an M6 spacer using a plastic nut containing an M6 nut.

Supply:
References by unit. Order by multiples of 20 units (20, 40, 60, etc.)



NSYTCSPLM

Characteristics	References
Plastic nut with self-tapping screw	NSYTCSPLM
Plastic nut containing an M6 metal nut	NSYTCSM6PLM

35 (1.38) mm (in.) symmetrical DIN rails

They are fixed to the rear of the enclosure without uprights, with a pitch of 25 (0.98) mm (in.) for the notches on the rear of the enclosure using direct-fixing nuts ref. **NSYTCSPLM** or **NSYTCSM6PLM**.

- Material: Galvanized steel

Supply:
References by unit. Order by multiples of 2 units (2, 4, 6, etc.)



NSYCS200PLM

Characteristics	For wall-mounted enclosure width mm (in.)	Rail length mm (in.)	References
35 (1.38) mm (in.) symmetrical DIN rails	215 (8.46)	180 (7.09)	NSYCS200PLM
35 (1.38) mm (in.) symmetrical DIN rails	330 (12.99)	280 (11.02)	NSYCS300PLM
35 (1.38) mm (in.) symmetrical DIN rails	430 (16.93)/ 436 (17.16)	380 (14.96)	NSYCS400PLM
35 (1.38) mm (in.) symmetrical DIN rails	536 (21.10)	480 (18.90)	NSYCS500PLM
35 (1.38) mm (in.) symmetrical DIN rails	636 (25.04)	580 (22.84)	NSYCS600PLM
35 (1.38) mm (in.) symmetrical DIN rails	852 (33.54)	795 (31.30)	NSYCS800PLM

Fixing inserts



Expanding inserts for addition to the M6 bosses of the enclosure, the M5 or M6 bosses of the door and the M8 bosses of the external rear part of the enclosure.

Supply:
References by unit. Order by multiples of 8 units (8, 16, 24, etc.). M5 and M6 inserts to be ordered in multiples of 20

Characteristics	Insert size	For wall-mounted enclosure	References
Fixing inserts	M5	NSYPLM43G and NSYPLM54G	NSYTEX5
Fixing inserts	M6	NSYPLM64G to NSYPLM108G	NSYTEX6
Fixing inserts	M8	For the rear of the enclosure	NSYTEX8PLM

Airing louvres



- They can be positioned inside the wall-mounted enclosures with heights from 430 (16.93) to 846 (33.31) mm (in.), allowing airing through the channels of the enclosure.

Supply:
References by unit. Order by multiples of 2 units (2, 4, 6, etc.)

Characteristics	References
Airing louvres	NSYCAG35LP

Water drain plug



- For drainage of condensed water. (Condensation should be eliminated using ClimaSys solution.) It is placed in the Ø 8.5 (0.34) mm (in.) (8.2 (0.32) mm (in.) for wall-mounted enclosures **NSYPLM32G**, **NSYPLM32TG**, **NSYPLM32PG** and **NSYPLM32BG**. diverse accessories) housing at the bottom of the enclosure.
- Ingress protection rating: IP53

Supply:
References by unit. Order by multiples of 10 units (10, 20, 30, etc.)

Characteristics	References
Water drain plug	NSYVEA9

ABS/PC wall-mounted enclosures

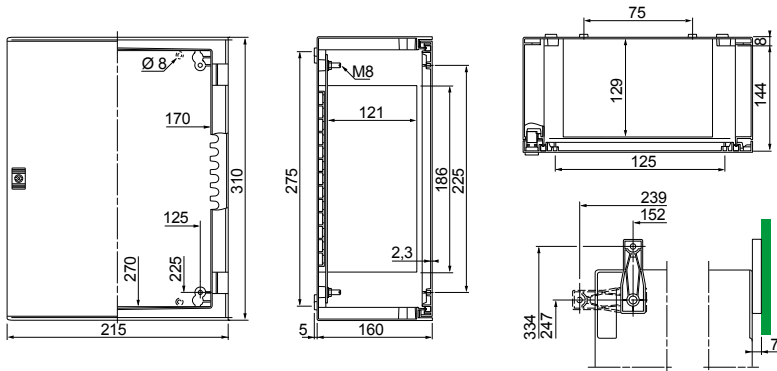

Polyester wall-mounted enclosures 308 (12.13) x 255 (10.04) mm (in.)

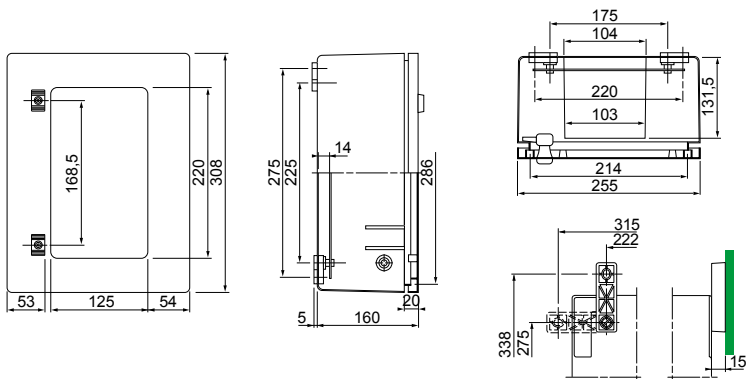

 Warning! This model is available with only one lock!

Other polyester wall-mounted enclosures

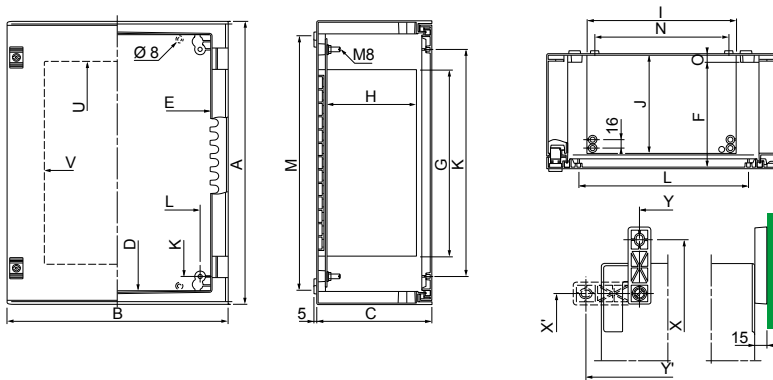

External fixing with lugs mm (in.)				
References	Vertical		Horizontal	
	X	Y	X'	Y'
NSYPLM43G	490 (19.29)	225 (8.86)	355 (13.98)	360 (14.17)
NSYPLM54G	590 (23.23)	325 (12.80)	455 (17.91)	460 (18.11)
NSYPLM64G	690 (27.16)	330 (12.99)	555 (21.85)	465 (18.31)
NSYPLM75G	790 (31.10)	430 (16.93)	655 (25.79)	565 (22.24)
NSYPLM86G	890 (35.04)	530 (20.87)	755 (29.72)	665 (26.18)
NSYPLM108G	1090 (42.91)	750 (29.53)	955 (37.60)	885 (34.84)

Glazed door opening mm (in.)		
References	U	V
NSYPLM43TG	273 (10.75)	194 (7.64)
NSYPLM43TVG	273 (10.75)	151 (5.94)
NSYPLM54TG	373 (14.68)	294 (11.58)
NSYPLM54TVG	373 (14.68)	251 (9.88)
NSYPLM64TG	463 (18.23)	294 (11.58)
NSYPLM64TVG	463 (18.23)	252 (9.92)
NSYPLM75TG	563 (22.16)	394 (15.51)
NSYPLM75TVG	563 (22.16)	352 (13.86)
NSYPLM86TG	663 (26.10)	494 (19.45)
NSYPLM86TVG	663 (26.10)	452 (17.80)
NSYPLM108TG	854 (33.62)	661 (26.02)

References	Dimensions mm (in.)										Bottom screw and door bosses mm (in.)		Internal fixing mm (in.)		
	A	B	C	D	E	F	G	H	I	J	K	L	M	N	O
NSYPLM43G	430 (16.93)	330 (12.99)	200 (7.87)	380 (14.96)	260 (10.24)	181 (7.13)	247 (9.72)	247 (9.72)	179 (7.05)	168 (6.61)	325 (12.80)	225 (8.86)	225 (8.86)	150 (5.91)	13 (0.51)
NSYPLM54G	530 (20.87)	430 (16.93)	200 (7.87)	480 (18.90)	360 (14.17)	181 (7.13)	347 (13.66)	347 (13.66)	279 (10.98)	168 (6.61)	425 (16.73)	325 (12.80)	325 (12.80)	250 (9.84)	13 (0.51)
NSYPLM64G	647 (25.47)	436 (17.16)	250 (9.84)	580 (22.84)	360 (14.17)	228 (8.98)	388 (15.28)	388 (15.28)	279 (10.98)	212 (8.35)	525 (20.67)	325 (12.80)	325 (12.80)	250 (9.84)	13 (0.51)
NSYPLM75G	747 (29.41)	536 (21.10)	300 (11.81)	680 (26.77)	460 (18.11)	278 (10.94)	487 (19.17)	487 (19.17)	379 (14.92)	261 (10.28)	625 (24.61)	425 (16.73)	425 (16.73)	350 (13.78)	15 (0.59)
NSYPLM86G	847 (33.35)	636 (25.04)	300 (11.81)	780 (30.71)	560 (22.05)	278 (10.94)	587 (23.11)	587 (23.11)	479 (18.86)	261 (10.28)	725 (28.54)	525 (20.67)	525 (20.67)	450 (17.72)	15 (0.59)
NSYPLM108G	1056 (41.58)	852 (33.54)	350 (13.78)	980 (38.58)	760 (29.92)	327 (12.87)	775 (30.51)	775 (30.51)	680 (26.77)	300 (11.81)	925 (36.42)	725 (28.54)	725 (28.54)	650 (25.59)	15 (0.59)



Insulated Floor-Standing Enclosures

PLA Version



PLAT Version



PLAZ Version



PLAZT Version

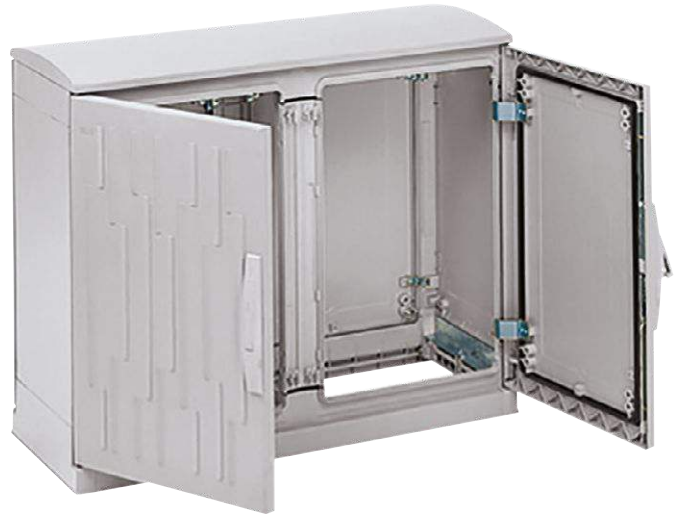

PLD Version



Thalassa PLA Polyester floor-standing enclosures

Introduction	214
Characteristics	215
Selection guide	216
Specific accessories	218
Dimensions	232

Polyester Floor-Standing Enclosures Thalassa PLA, PLAT, PLAZ, PLAZT, Introduction

The **floor-standing enclosures** are made of **polyester reinforced with fiberglass**, molded by hot compression. High resistance to corrosion in harsh environments, it maintains its mechanical and insulation properties.



New Bigger dimensions

Enclosures with a height of 2000 (78.74) mm (in.) and a depth of 620 (24.41) mm (in.) have been included to suit the demands of industry and infrastructure for the integration of motor controllers, power distribution, electronic or telecommunication devices

PLAT version



Airing

- Open top with canopy allows passive airing.



Easy mounting

- Various bosses for M8 inserts.

PLAZ version



Open bottom

- Big open bottom to be mounted directly on the floor or on a plinth.



Smart interior

- Plain mounted plate installed on step slides and compulsory adapter plates in all the enclosures with open bottom part.

PLAZT version

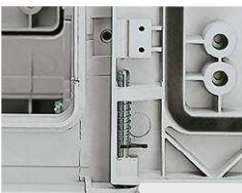

Easy installation

- Door opening to 180°.



Resistant

- Anti lever security system..

For details consult our web site www.se.com



Prolonged exposure to UV radiation, wind and rain can cause aesthetics changes in the external surface of the enclosure. Without affecting the technical properties according to IEC 62208. For long exposure applications, it is recommended to use painted enclosures available through the P&S offer.



Class II



Characteristics	PLA version	PLAT version	PLAZ version	PLAZT version
	<p>Completely sealed enclosure Enclosure obtained by assembling:</p> <ul style="list-style-type: none"> • 1 sealed top part, • 1 sealed bottom part, • 2 side parts, • 1 or 2 rear panels (depending on width), • 1 or 2 doors (depending on width). • Locking system with handle with a 5 (0.20) mm (in.) double-bar insert block, included in the standard supply. Other blocks with inserts or barrels and keys optionally available. • Door opening to 120°. 	<p>Enclosure with ventilated canopy Enclosure obtained by assembling:</p> <ul style="list-style-type: none"> • 1 open top part with canopy, • 1 sealed bottom part, • 2 side parts, • 1 or 2 rear panels (depending on width), • 1 or 2 doors (depending on width). • Locking system with handle with a 5 (0.20) mm (in.) double-bar insert block, included in the standard supply. Other blocks with inserts or barrels and keys optionally available. • Door opening to 120°. 	<p>Enclosure with open bottom Enclosure obtained by assembling:</p> <ul style="list-style-type: none"> • 1 sealed top part, • 1 plinth-type open bottom part, • 2 side parts, • 1 or 2 rear panels (depending on width), • 1 or 2 doors (depending on width). • Locking system with handle with a 5 (0.20) mm (in.) double-bar insert block, included in the standard supply. Other blocks with inserts or barrels and keys optionally available. • Door opening to 120°. 	<p>Enclosure with open bottom and ventilated canopy</p> <ul style="list-style-type: none"> • Enclosure obtained by assembling: • 1 open top part with canopy, • 1 plinth-type open bottom part, • 2 side parts, • 1 or 2 rear panels (depending on width), • 1 or 2 doors (depending on width). • Locking system with handle with a 5 (0.20) mm (in.) double-bar insert block. Other blocks with inserts or barrels and keys optionally available. • Door opening to 180°. • Anti-lever system to help prevent forcing of the door.
Material	<ul style="list-style-type: none"> • Polyester reinforced with fiberglass 			
Finish	<ul style="list-style-type: none"> • Molded by hot compression: The pieces have an excellent finish on both sides and can include numerous bosses for accommodating inserts and mounting or cable management accessories 			
Color	<ul style="list-style-type: none"> • RAL 7035 grey 			
Ingress protection rating	IP65 according to IEC 60529	<ul style="list-style-type: none"> • IP44 according to IEC 60529 • IP54 with 1 or 2 internal grilles, ref. NSYCAG125LPF, to be ordered separately. 	IP54 according to IEC 60529	<ul style="list-style-type: none"> • IP44 according to IEC 60529 • IP54 with 1 or 2 internal grilles, ref. NSYCAG125LPF, to be ordered separately
Mechanical protection rating	IK10 (20 joules) plain door - IEC62262 and IK08 glazed door			
Insulation	<ul style="list-style-type: none"> • Class II according to IEC 60950-1 if the mounting process follows the included mounting instructions sheet 			
Certifications	<ul style="list-style-type: none"> • UL 508A/CAN-CSA 22 • Single-door: NEMA types 1, 2, 3, 3R, 3S, 5, 12 and 13 • Double-door: NEMA types 1, 2, 12 and 13 • Bureau Veritas Marine • IEC 62208 	<ul style="list-style-type: none"> • IEC 62208 		
Installation	<ul style="list-style-type: none"> • Indoor use only. For outdoor use, must install a canopy 	<ul style="list-style-type: none"> • Outdoor or indoor installation 		
	<ul style="list-style-type: none"> • Direct fixing to the floor or by means of a plinth with a height of 60 (2.36) mm (in.), as an option, see page 220 • Possibility of fixing on a semi-embedded plinth, see page 220 • Optional wall fixing lugs 		<ul style="list-style-type: none"> • The open bottom part forms a 60 (2.36) mm (in.) plinth which is fixed to the floor directly or by means of an optional fixing frame, see page 222, or else it is installed on a semi-embedded plinth, see page 222 	
Options	<ul style="list-style-type: none"> • The versions with glassed door must be protected against the direct sunlight to avoid overheating. • Anti-posting door upon request 			

PHD - Applicative solutions:
See the Polyester Heavy-Duty offer in the Applicative solutions, [page 324](#).

Polyester Floor-Standing Enclosures

Thalassa PLA, PLAZ, Selection Guide



Indoor and Outdoor:
Outdoor use requires the installation of a canopy.

Completely sealed enclosures, IP65



PLA



PLA



PLAZ

Enclosures with open bottom part, IP54

Dimensions				Completely sealed enclosures, IP65		Enclosures with open bottom part, IP54
Height mm (in.)	Width mm (in.)	Depth mm (in.)	N° of doors	Plain	Glazed**	Plain
500 (19.68)	500 (19.68)	320 (12.60)	1	NSYPLA553G	NSYPLA553TG	NSYPLAZ553G
500 (19.68)	500 (19.68)	420 (16.54)	1	NSYPLA554G	NSYPLA554TG	NSYPLAZ554G
500 (19.68)	750 (29.53)	320 (12.60)	1	NSYPLA573G	NSYPLA573TG	NSYPLAZ573G
500 (19.68)	750 (29.53)	420 (16.54)	1	NSYPLA574G	NSYPLA574TG	NSYPLAZ574G
500 (19.68)	1000 (39.37)	320 (12.60)	2	NSYPLA5103G	NSYPLA5103TG	NSYPLAZ5103G
500 (19.68)	1000 (39.37)	420 (16.54)	2	NSYPLA5104G	NSYPLA5104TG	NSYPLAZ5104G
500 (19.68)	1250 (49.21)	320 (12.60)	2	NSYPLA5123G	NSYPLA5123TG	NSYPLAZ5123G
500 (19.68)	1250 (49.21)	420 (16.54)	2	NSYPLA5124G	NSYPLA5124TG	NSYPLAZ5124G
750 (29.53)	500 (19.68)	320 (12.60)	1	NSYPLA753G	NSYPLA753TG	NSYPLAZ753G
750 (29.53)	500 (19.68)	420 (16.54)	1	NSYPLA754G	NSYPLA754TG	NSYPLAZ754G
750 (29.53)	750 (29.53)	320 (12.60)	1	NSYPLA773G	NSYPLA773TG	NSYPLAZ773G
750 (29.53)	750 (29.53)	420 (16.54)	1	NSYPLA774G	NSYPLA774TG	NSYPLAZ774G
750 (29.53)	750 (29.53)	620 (24.41)	1	NSYPLA776G	NSYPLA776TG	NSYPLAZ776G
750 (29.53)	1000 (39.37)	320 (12.60)	2	NSYPLA7103G	NSYPLA7103TG	NSYPLAZ7103G
750 (29.53)	1000 (39.37)	420 (16.54)	2	NSYPLA7104G	NSYPLA7104TG	NSYPLAZ7104G
750 (29.53)	1250 (49.21)	320 (12.60)	2	NSYPLA7123G	NSYPLA7123TG	NSYPLAZ7123G
750 (29.53)	1250 (49.21)	420 (16.54)	2	NSYPLA7124G	NSYPLA7124TG	NSYPLAZ7124G
1000 (39.37)	500 (19.68)	320 (12.60)	1	NSYPLA1053G	NSYPLA1053TG	NSYPLAZ1053G
1000 (39.37)	500 (19.68)	420 (16.54)	1	NSYPLA1054G	NSYPLA1054TG	NSYPLAZ1054G
1000 (39.37)	750 (29.53)	320 (12.60)	1	NSYPLA1073G	NSYPLA1073TG	NSYPLAZ1073G
1000 (39.37)	750 (29.53)	420 (16.54)	1	NSYPLA1074G	NSYPLA1074TG	NSYPLAZ1074G
1000 (39.37)	1000 (39.37)	320 (12.60)	2	NSYPLA10103G	NSYPLA10103TG	NSYPLAZ10103G
1000 (39.37)	1000 (39.37)	420 (16.54)	2	NSYPLA10104G	NSYPLA10104TG	NSYPLAZ10104G
1000 (39.37)	1250 (49.21)	320 (12.60)	2	NSYPLA10123G	NSYPLA10123TG	NSYPLAZ10123G
1000 (39.37)	1250 (49.21)	420 (16.54)	2	NSYPLA10124G	NSYPLA10124TG	NSYPLAZ10124G
1250 (49.21)	500 (19.68)	320 (12.60)	1	NSYPLA1253G	NSYPLA1253TG	NSYPLAZ1253G
1250 (49.21)	500 (19.68)	420 (16.54)	1	NSYPLA1254G	NSYPLA1254TG	NSYPLAZ1254G
1250 (49.21)	750 (29.53)	320 (12.60)	1	NSYPLA1273G	NSYPLA1273TG	NSYPLAZ1273G
1250 (49.21)	750 (29.53)	420 (16.54)	1	NSYPLA1274G	NSYPLA1274TG	NSYPLAZ1274G
1250 (49.21)	750 (29.53)	620 (24.41)	1	NSYPLA1276G	NSYPLA1276TG	NSYPLAZ1276G
1250 (49.21)	1000 (39.37)	320 (12.60)	2	NSYPLA12103G	NSYPLA12103TG	NSYPLAZ12103G
1250 (49.21)	1000 (39.37)	420 (16.54)	2	NSYPLA12104G	NSYPLA12104TG	NSYPLAZ12104G
1250 (49.21)	1250 (49.21)	320 (12.60)	2	NSYPLA12123G	NSYPLA12123TG	NSYPLAZ12123G
1250 (49.21)	1250 (49.21)	420 (16.54)	2	NSYPLA12124G	NSYPLA12124TG	NSYPLAZ12124G
1250 (49.21)	1250 (49.21)	620 (24.41)	2	NSYPLA12126G	NSYPLA12126TG	NSYPLAZ12126G
1500 (59.06)	500 (19.68)	320 (12.60)	1	NSYPLA1553G	NSYPLA1553TG	NSYPLAZ1553G
1500 (59.06)	500 (19.68)	420 (16.54)	1	NSYPLA1554G	NSYPLA1554TG	NSYPLAZ1554G
1500 (59.06)	750 (29.53)	320 (12.60)	1	NSYPLA1573G	NSYPLA1573TG	NSYPLAZ1573G
1500 (59.06)	750 (29.53)	420 (16.54)	1	NSYPLA1574G	NSYPLA1574TG	NSYPLAZ1574G
1500 (59.06)	750 (29.53)	620 (24.41)	1	NSYPLA1576G	NSYPLA1576TG	NSYPLAZ1576G
1500 (59.06)	1000 (39.37)	320 (12.60)	2	NSYPLA15103G	NSYPLA15103TG	NSYPLAZ15103G
1500 (59.06)	1000 (39.37)	420 (16.54)	2	NSYPLA15104G	NSYPLA15104TG	NSYPLAZ15104G
1500 (59.06)	1250 (49.21)	320 (12.60)	2	NSYPLA15123G	NSYPLA15123TG	NSYPLAZ15123G
1500 (59.06)	1250 (49.21)	420 (16.54)	2	NSYPLA15124G	NSYPLA15124TG	NSYPLAZ15124G
1500 (59.06)	1250 (49.21)	620 (24.41)	2	NSYPLA15126G	NSYPLA15126TG	NSYPLAZ15126G
2000 (78.74)	750 (29.53)	420 (16.54)	2*	NSYPLA2074G	NSYPLA2074TG	NSYPLAZ2074G

*Two doors in vertical.

**Recommended to protect against the direct UV radiation.

PHD - Applicative solutions:

See the Polyester Heavy-Duty offer in the applicative solutions, [page 324](#).

Technical changes reserved. Information provided without guarantee. Images are for illustrative purposes only.



Indoor and Outdoor:
Outdoor use requires the installation of a canopy.

Enclosures with ventilated canopy, IP44



PLAT

Enclosures with open bottom part and ventilated canopy, IP44



PLAZT

Dimensions				Plain	Plain
Height mm (in.)	Width mm (in.)	Depth mm (in.)	N° of doors		
500 (19.68)	500 (19.68)	320 (12.60)	1	NSYPLAT553G	NSYPLAZT553G
500 (19.68)	500 (19.68)	420 (16.54)	1	NSYPLAT554G	NSYPLAZT554G
500 (19.68)	750 (29.53)	320 (12.60)	1	NSYPLAT573G	NSYPLAZT573G
500 (19.68)	750 (29.53)	420 (16.54)	1	NSYPLAT574G	NSYPLAZT574G
500 (19.68)	1000 (39.37)	320 (12.60)	2	NSYPLAT5103G	NSYPLAZT5103G
500 (19.68)	1000 (39.37)	420 (16.54)	2	NSYPLAT5104G	NSYPLAZT5104G
500 (19.68)	1250 (49.21)	320 (12.60)	2	NSYPLAT5123G	NSYPLAZT5123G
500 (19.68)	1250 (49.21)	420 (16.54)	2	NSYPLAT5124G	NSYPLAZT5124G
750 (29.53)	500 (19.68)	320 (12.60)	1	NSYPLAT753G	NSYPLAZT753G
750 (29.53)	500 (19.68)	420 (16.54)	1	NSYPLAT754G	NSYPLAZT754G
750 (29.53)	750 (29.53)	320 (12.60)	1	NSYPLAT773G	NSYPLAZT773G
750 (29.53)	750 (29.53)	420 (16.54)	1	NSYPLAT774G	NSYPLAZT774G
750 (29.53)	750 (29.53)	620 (24.41)	1	NSYPLAT776G	NSYPLAZT776G
750 (29.53)	1000 (39.37)	320 (12.60)	2	NSYPLAT7103G	NSYPLAZT7103G
750 (29.53)	1000 (39.37)	420 (16.54)	2	NSYPLAT7104G	NSYPLAZT7104G
750 (29.53)	1250 (49.21)	320 (12.60)	2	NSYPLAT7123G	NSYPLAZT7123G
750 (29.53)	1250 (49.21)	420 (16.54)	2	NSYPLAT7124G	NSYPLAZT7124G
1000 (39.37)	500 (19.68)	320 (12.60)	1	NSYPLAT1053G	NSYPLAZT1053G
1000 (39.37)	500 (19.68)	420 (16.54)	1	NSYPLAT1054G	NSYPLAZT1054G
1000 (39.37)	750 (29.53)	320 (12.60)	1	NSYPLAT1073G	NSYPLAZT1073G
1000 (39.37)	750 (29.53)	420 (16.54)	1	NSYPLAT1074G	NSYPLAZT1074G
1000 (39.37)	1000 (39.37)	320 (12.60)	2	NSYPLAT10103G	NSYPLAZT10103G
1000 (39.37)	1000 (39.37)	420 (16.54)	2	NSYPLAT10104G	NSYPLAZT10104G
1000 (39.37)	1250 (49.21)	320 (12.60)	2	NSYPLAT10123G	NSYPLAZT10123G
1000 (39.37)	1250 (49.21)	420 (16.54)	2	NSYPLAT10124G	NSYPLAZT10124G
1250 (49.21)	500 (19.68)	320 (12.60)	1	NSYPLAT1253G	NSYPLAZT1253G
1250 (49.21)	500 (19.68)	420 (16.54)	1	NSYPLAT1254G	NSYPLAZT1254G
1250 (49.21)	750 (29.53)	320 (12.60)	1	NSYPLAT1273G	NSYPLAZT1273G
1250 (49.21)	750 (29.53)	420 (16.54)	1	NSYPLAT1274G	NSYPLAZT1274G
1250 (49.21)	750 (29.53)	620 (24.41)	1	NSYPLAT1276G	NSYPLAZT1276G
1250 (49.21)	1000 (39.37)	320 (12.60)	2	NSYPLAT12103G	NSYPLAZT12103G
1250 (49.21)	1000 (39.37)	420 (16.54)	2	NSYPLAT12104G	NSYPLAZT12104G
1250 (49.21)	1250 (49.21)	320 (12.60)	2	NSYPLAT12123G	NSYPLAZT12123G
1250 (49.21)	1250 (49.21)	420 (16.54)	2	NSYPLAT12124G	NSYPLAZT12124G
1250 (49.21)	1250 (49.21)	620 (24.41)	2	NSYPLAT12126G	NSYPLAZT12126G
1500 (59.06)	500 (19.68)	320 (12.60)	1	NSYPLAT1553G	NSYPLAZT1553G
1500 (59.06)	500 (19.68)	420 (16.54)	1	NSYPLAT1554G	NSYPLAZT1554G
1500 (59.06)	750 (29.53)	320 (12.60)	1	NSYPLAT1573G	NSYPLAZT1573G
1500 (59.06)	750 (29.53)	420 (16.54)	1	NSYPLAT1574G	NSYPLAZT1574G
1500 (59.06)	750 (29.53)	620 (24.41)	1	NSYPLAT1576G	NSYPLAZT1576G
1500 (59.06)	1000 (39.37)	320 (12.60)	2	NSYPLAT15103G	NSYPLAZT15103G
1500 (59.06)	1000 (39.37)	420 (16.54)	2	NSYPLAT15104G	NSYPLAZT15104G
1500 (59.06)	1250 (49.21)	320 (12.60)	2	NSYPLAT15123G	NSYPLAZT15123G
1500 (59.06)	1250 (49.21)	420 (16.54)	2	NSYPLAT15124G	NSYPLAZT15124G
1500 (59.06)	1250 (49.21)	620 (24.41)	2	NSYPLAT15126G	NSYPLAZT15126G
2000 (78.74)	750 (29.53)	420 (16.54)	2*	NSYPLAT2074G	NSYPLAZT2074G

*Two doors in vertical.

PHD - Applicative solutions:

See the Polyester Heavy-Duty offer in the applicative solutions, [page 324](#).

Technical changes reserved. Information provided without guarantee. Images are for illustrative purposes only.

Horizontal coupling kits, 15 (0.59) mm (in.), joining two enclosures mounted on ZA plinths

- For coupling two enclosures side by side.
- Coupling frame kit: Made up of a coupling kit and the fixings required for installation.
- Trim kit: Made up of two frames for aesthetic fitting of the two coupled enclosures
- Coupling kit widths: 15 (0.59) mm (in.), joining two enclosures mounted on ZA plinths
- Ingress protection rating: IP55 at the coupling point

Note:
Not valid for coupling two enclosures using ZZ or ZH type plinth.

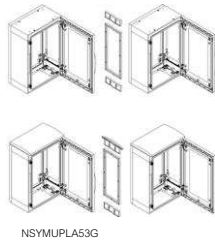

Characteristics	Depth mm (in.)	Height mm (in.)	References
Coupling frame kit 15 (0.59) mm (in.)	320 (12.60)	500 (19.68)	NSYMUPLA53G
Coupling frame kit 15 (0.59) mm (in.)	320 (12.60)	750 (29.53)	NSYMUPLA73G
Coupling frame kit 15 (0.59) mm (in.)	320 (12.60)	1000 (39.37)	NSYMUPLA103G
Coupling frame kit 15 (0.59) mm (in.)	320 (12.60)	1250 (49.21)	NSYMUPLA123G
Coupling frame kit 15 (0.59) mm (in.)	320 (12.60)	1500 (59.06)	NSYMUPLA153G
Coupling frame kit 15 (0.59) mm (in.)	420 (16.54)	500 (19.68)	NSYMUPLA54G
Coupling frame kit 15 (0.59) mm (in.)	420 (16.54)	750 (29.53)	NSYMUPLA74G
Coupling frame kit 15 (0.59) mm (in.)	420 (16.54)	1000 (39.37)	NSYMUPLA104G
Coupling frame kit 15 (0.59) mm (in.)	420 (16.54)	1250 (49.21)	NSYMUPLA124G
Coupling frame kit 15 (0.59) mm (in.)	420 (16.54)	1500 (59.06)	NSYMUPLA154G
Coupling frame kit 15 (0.59) mm (in.)	420 (16.54)	2000 (78.74)	NSYMUPLA204G
Coupling frame kit 15 (0.59) mm (in.)	620 (24.41)	750 (29.53)	NSYMUPLA76G
Coupling frame kit 15 (0.59) mm (in.)	620 (24.41)	1250 (49.21)	NSYMUPLA126G
Coupling frame kit 15 (0.59) mm (in.)	620 (24.41)	1500 (59.06)	NSYMUPLA156G
Trim kit for enclosure without canopy	320 (12.60)	-	NSYSUPLA3G
Trim kit for enclosure with canopy	320 (12.60)	-	NSYSUPLA3TG
Trim kit for enclosure without canopy	420 (16.54)	-	NSYSUPLA4G
Trim kit for enclosure with canopy	420 (16.54)	-	NSYSUPLA4TG

Horizontal coupling kits, 35 (1.38) mm (in.), joining two enclosures mounted on ZZ or ZH plinths

- For coupling two enclosures side by side.
- Coupling frame kit: Made up of a coupling kit and the fixings required for installation.
- Trim kit: Made up of two frames for aesthetic fitting of the two coupled enclosures
- Coupling kit widths: 35 (1.38) mm (in.), joining two enclosures mounted on ZZ or ZH plinths
- Ingress protection rating: IP55 at the coupling point

Note:
Not valid for coupling two enclosures using ZA plinths

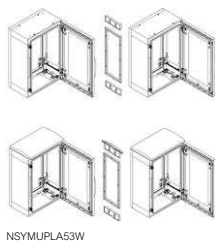

Characteristics	Depth mm (in.)	Height mm (in.)	References
Coupling frame kit 35 (1.38) mm (in.)	320 (12.60)	500 (19.68)	NSYMUPLA53W
Coupling frame kit 35 (1.38) mm (in.)	320 (12.60)	750 (29.53)	NSYMUPLA73W
Coupling frame kit 35 (1.38) mm (in.)	320 (12.60)	1000 (39.37)	NSYMUPLA103W
Coupling frame kit 35 (1.38) mm (in.)	320 (12.60)	1250 (49.21)	NSYMUPLA123W
Coupling frame kit 35 (1.38) mm (in.)	320 (12.60)	1500 (59.06)	NSYMUPLA153W
Coupling frame kit 35 (1.38) mm (in.)	420 (16.54)	500 (19.68)	NSYMUPLA54W
Coupling frame kit 35 (1.38) mm (in.)	420 (16.54)	750 (29.53)	NSYMUPLA74W
Coupling frame kit 35 (1.38) mm (in.)	420 (16.54)	1000 (39.37)	NSYMUPLA104W
Coupling frame kit 35 (1.38) mm (in.)	420 (16.54)	1250 (49.21)	NSYMUPLA124W
Coupling frame kit 35 (1.38) mm (in.)	420 (16.54)	1500 (59.06)	NSYMUPLA154W
Coupling frame kit 35 (1.38) mm (in.)	420 (16.54)	2000 (78.74)	NSYMUPLA204W
Coupling frame kit 35 (1.38) mm (in.)	620 (24.41)	750 (29.53)	NSYMUPLA76W
Coupling frame kit 35 (1.38) mm (in.)	620 (24.41)	1250 (49.21)	NSYMUPLA126W
Coupling frame kit 35 (1.38) mm (in.)	620 (24.41)	1500 (59.06)	NSYMUPLA156W

Vertical coupling kit

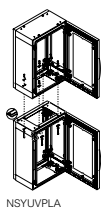

- For coupling two enclosures on top of one another.
- Kit made up of 3.5 (137.80) mm (in.) of adhesive seal and the fixings required for mounting.
- Ingress protection rating: IP55 at the coupling point

Characteristics	References
Vertical coupling kit	NSYUVPPLA

Canopy

- Can be installed in all enclosure models.
- High resistance to impacts, temperature and bad weather.
- Increases the height (A) of the enclosure by 38 (1.50) mm (in.) without modifying its width or depth.
- Material: Polyester reinforced with fiberglass
- Color: RAL 7035 grey
- Installation: Essential for outdoor use

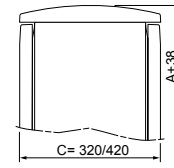

Supply:
Delivered with the fixings required for installation



NSYTJPLA53G

Characteristics	Width mm (in.)	Depth mm (in.)	References
Canopy	500 (19.68)	320 (12.60)	NSYTJPLA53G
Canopy	500 (19.68)	420 (16.54)	NSYTJPLA54G
Canopy	750 (29.53)	320 (12.60)	NSYTJPLA73G
Canopy	750 (29.53)	420 (16.54)	NSYTJPLA74G
Canopy	750 (29.53)	620 (24.41)	NSYTJPLA76G
Canopy	1000 (39.37)	320 (12.60)	NSYTJPLA103G
Canopy	1000 (39.37)	420 (16.54)	NSYTJPLA104G
Canopy	1250 (49.21)	320 (12.60)	NSYTJPLA123G
Canopy	1250 (49.21)	420 (16.54)	NSYTJPLA124G
Canopy	1250 (49.21)	620 (24.41)	NSYTJPLA126G

Wall fixing lugs



NSYFMPLA

Drilling positions and marks inside the side panels.

- Material: Passivated zinc-coated steel
 - Maximum load: 180 (396.83) kg (lbs.) including weight of enclosure
- Fixing:** Fixing on the sides by four or six lugs in horizontal position (six lugs for enclosures with height \geq 1000 (39.37) mm (in.)) 10 (0.39) mm (in.) fixing distance on the rear of the enclosure plane

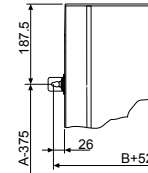

Supply:
Set of six lugs and fixings

Characteristics	References
Wall fixing lugs	NSYFMPLA

PLAZ PLAZT Cable entry plate

- Easy drilling in specific customized version.
- Not compatible with: Adapter plates, step slides, internal door and chassis for modular distribution.
- Material: Polyester reinforced with fiberglass
- Thickness: 4 (0.16) mm (in.)

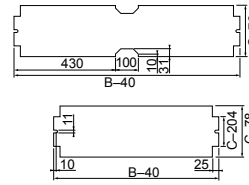

Supply:
Delivered with the fixings required for installation



NSYECPLAZ53G

Characteristics	Width mm (in.)	Depth mm (in.)	References
Cable entry plate	500 (19.68)	320 (12.60)	NSYECPLAZ53G
Cable entry plate	500 (19.68)	420 (16.54)	NSYECPLAZ54G
Cable entry plate	750 (29.53)	320 (12.60)	NSYECPLAZ73G
Cable entry plate	750 (29.53)	420 (16.54)	NSYECPLAZ74G
Cable entry plate	750 (29.53)	620 (24.41)	NSYECPLAZ76G
Cable entry plate	1000 (39.37)	320 (12.60)	NSYECPLAZ103G
Cable entry plate	1000 (39.37)	420 (16.54)	NSYECPLAZ104G
Cable entry plate	1250 (49.21)	320 (12.60)	NSYECPLAZ123G
Cable entry plate	1250 (49.21)	420 (16.54)	NSYECPLAZ124G
Cable entry plate	1250 (49.21)	620 (24.41)	NSYECPLAZ126G



Characteristics	ZA plinths for PLA and PLAT versions
	<ul style="list-style-type: none"> The front parts of the plinth (front and rear) have two stainless-steel screws protected by a plastic cap; these screws, which can be accessed from the outside, make it possible (using an Allen key) to open and remove the front parts for easier cable installation. In stacked position, the bottom plinth can be partially buried. It is provided with one or two reinforcement cross-rails, adjustable to adjust to the position of the cables.
Material	Polyester reinforced with fiberglass
Color	RAL 7035 grey
Ingress protection rating	IP44
Mechanical protection rating	IK10
Fixing	Four floor attachment points; symmetry of the parts prevents incorrect assembly
Supply	The reference of the plinth contains all the accessories required for attaching the enclosure to the plinth and for stacking two plinths

For floor-standing enclosure		Plinth		Cable gland area		Height 200 (7.87) mm (in.)	
Width mm (in.)	Depth mm (in.)	References	Width mm (in.)	Depth mm (in.)	Width mm (in.)	Depth mm (in.)	References
500 (19.68)	320 (12.60)	NSYPLA(T)●53G	494 (19.45)	250 (9.84)	360 (14.17)	205 (8.07)	NSYZA253G
750 (29.53)	320 (12.60)	NSYPLA(T)●73G	744 (29.29)	250 (9.84)	610 (24.02)	205 (8.07)	NSYZA273G
1000 (39.37)	320 (12.60)	NSYPLA(T)●103G	994 (39.13)	250 (9.84)	860 (33.86)	205 (8.07)	NSYZA2103G
1250 (49.21)	320 (12.60)	NSYPLA(T)●123G	1244 (48.98)	250 (9.84)	1100 (43.31)	205 (8.07)	NSYZA2123G
500 (19.68)	420 (16.54)	NSYPLA(T)●54G	494 (19.45)	350 (13.78)	360 (14.17)	305 (12.01)	NSYZA254G
750 (29.53)	420 (16.54)	NSYPLA(T)●74G	744 (29.29)	350 (13.78)	610 (24.02)	305 (12.01)	NSYZA274G
1000 (39.37)	420 (16.54)	NSYPLA(T)●104G	994 (39.13)	350 (13.78)	860 (33.86)	305 (12.01)	NSYZA2104G
1250 (49.21)	420 (16.54)	NSYPLA(T)●124G	1244 (48.98)	350 (13.78)	1110 (43.70)	305 (12.01)	NSYZA2124G
750 (29.53)	620 (24.41)	NSYPLA(T)●76G	744 (29.29)	550 (21.65)	610 (24.02)	505 (19.88)	NSYZA276G
1250 (49.21)	620 (24.41)	NSYPLA(T)●126G	1244 (48.98)	550 (21.65)	1110 (43.70)	505 (19.88)	NSYZA2126G

Cable supporting cross-rail

- Description: The lateral sides of the plinth are provided with bosses for attaching cross-rails with cut-out profiles, for supporting cables.

Supply:
the reference of the cross-rail includes all the elements required for assembly.



Characteristics	For plinth	For plinth	References
Cable supporting cross-rail	NSYZA253G	NSYZA254G	NSYAC320
Cable supporting cross-rail	NSYZA273G	NSYZA274G	NSYAC560
Cable supporting cross-rail	NSYZA2103G	NSYZA2104G	NSYAC840
Cable supporting cross-rail	NSYZA2123G	NSYZA2124G	NSYAC1080

Feet for partially buried installation

Description: Allows the partially buried installation of plinths before completion of the floor. The plinths are attached by four feet with a standard length of 750 (29.53) mm (in.). Possibility of horizontal adjustment of the plinth.

Supply:
Kit includes four feet and fixings.



NSYAEBFZ

Characteristics	References
Feet for partially buried installation	NSYAEBFZ

N plinths

Designed to be installed under the closed bottom enclosures (version PLA or PLAT).

- Material: Polyester reinforced with fiberglass
- Color: RAL 7035 grey
- Height 60 (2.36) mm (in.)

Supply:
Delivered with fixings required for installation



NSYZNPLA53G

Characteristics	References
N plinths	NSYZNPLA53G
N plinths	NSYZNPLA73G
N plinths	NSYZNPLA103G
N plinths	NSYZNPLA123G
N plinths	NSYZNPLA54G
N plinths	NSYZNPLA74G
N plinths	NSYZNPLA104G
N plinths	NSYZNPLA124G

Connectors between plinths

Description: Designed to allow the adaptation of a closed bottom enclosure + N plinth on a H-type partially buried plinth.

- NSYPLA or NSYPLAT not for NSYPLAZ●●●
- NSYZNPLA●●●
- NSYAZ●●●
- NSYZHPLA●●●

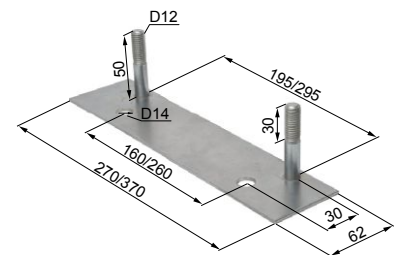
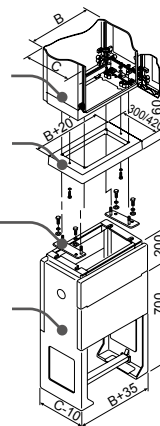

Supply:
two parts for adapting the center-to-center distances.



NSYAZ3PLA

Characteristics	For floor-standing enclosure Depth mm (in.)	References
Linking parts for N plinth on 320 (12.60) mm (in.) H plinth	320 (12.60)	NSYAZ3PLA
Linking parts for N plinth on 420 (16.54) mm (in.) H plinth	420 (16.54)	NSYAZ4PLA



(1) For enclosures using ZZ or ZH type plinths the coupling kit to use is the **NSYMUPLA●●●W**.

Characteristics	ZZ plinths for PLAZ and PLAZT versions ⁽¹⁾
	<ul style="list-style-type: none"> The front parts (front and rear) are removed from the inside. Removing them makes it easier to install the cables. The 500 (19.68) mm (in.) plinth can be partially buried. It is provided with one or two reinforcement cross-rails, adjustable to adapt to the position of the cables.
Material	Polyester reinforced with fiberglass
Color	RAL 7035 grey
Ingress protection rating	IP44
Mechanical protection rating	IK10
Fixing	Four floor attachment points; The symmetry of the parts prevents incorrect assembly
Supply	The reference of the plinth contains all the accessories required for attaching the enclosure to the plinth

For floor-standing enclosure			Plinth		Cable gland area		Height 200 (7.87) mm (in.)	Height 500 (19.68) mm (in.)
Width mm (in.) (B)	Depth mm (in.) (C)	References	Width mm (in.)	Depth mm (in.)	Width mm (in.)	Depth mm (in.)	References	References
500 (19.68)	320 (12.60)	NSYPLAZ(T)●53G	535 (21.06)	310 (12.20)	419 (16.50)	252 (9.92)	NSYZZ253G	NSYZZ553G
750 (29.53)	320 (12.60)	NSYPLAZ(T)●73G	785 (30.91)	310 (12.20)	669 (26.34)	252 (9.92)	NSYZZ273G	NSYZZ573G
1000 (39.37)	320 (12.60)	NSYPLAZ(T)●103G	1035 (40.75)	310 (12.20)	919 (36.18)	252 (9.92)	NSYZZ2103G	NSYZZ5103G
1250 (49.21)	320 (12.60)	NSYPLAZ(T)●123G	1285 (50.59)	310 (12.20)	1169 (46.02)	252 (9.92)	NSYZZ2123G	NSYZZ5123G
500 (19.68)	420 (16.54)	NSYPLAZ(T)●54G	535 (21.06)	410 (16.14)	419 (16.50)	352 (13.86)	NSYZZ254G	NSYZZ554G
750 (29.53)	420 (16.54)	NSYPLAZ(T)●74G	785 (30.91)	410 (16.14)	669 (26.34)	352 (13.86)	NSYZZ274G	NSYZZ574G
1000 (39.37)	420 (16.54)	NSYPLAZ(T)●104G	1035 (40.75)	410 (16.14)	919 (36.18)	352 (13.86)	NSYZZ2104G	NSYZZ5104G
1250 (49.21)	420 (16.54)	NSYPLAZ(T)●124G	1285 (50.59)	410 (16.14)	1169 (46.02)	352 (13.86)	NSYZZ2124G	NSYZZ5124G
750 (29.53)	620 (24.41)	NSYPLAZ(T)●76G	785 (30.91)	610 (24.02)	669 (26.34)	552 (21.73)	NSYZZ276G	-
1250 (49.21)	620 (24.41)	NSYPLAZ(T)●126G	1285 (50.59)	610 (24.02)	1169 (46.02)	552 (21.73)	NSYZZ2126G	-

Cable supporting cross-rail

- Description: The sides of the plinths are provided with bosses for the attachment of cross-rails with cutout profiles that support the cables.

Supply:

The reference of the cross-rail includes all elements required for assembly.

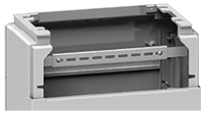

NSYAC360

Characteristics	For plinth	For plinth	For plinth	For plinth	References
Cable supporting cross-rail	NSYZZ253G	NSYZZ254G	NSYZZ553G	NSYZZ554G	NSYAC360
Cable supporting cross-rail	NSYZZ273G	NSYZZ274G	NSYZZ573G	NSYZZ574G	NSYAC600
Cable supporting cross-rail	NSYZZ2103G	NSYZZ2104G	NSYZZ5103G	NSYZZ5104G	NSYAC840
Cable supporting cross-rail	NSYZZ2123G	NSYZZ2124G	NSYZZ5123G	NSYZZ5124G	NSYAC1120

Outside opening kit



NSYAE LZ

- Description: The 200 (7.87) mm (in.) front part of the 200 (7.87) and 500 (19.68) mm (in.) plinths can be opened from the outside, after installing a kit made up of two locks with double-bar insert.

Characteristics	References
Outside opening kit	NSYAE LZ

Buriable H plinths



NSYZHPLA53G

- Front panel with a height of 170 (6.69) mm (in.), retractable, providing easy access to the inside.
- Fixed front panel with a height of 305 (12.01) mm (in.), corresponding to the finished floor height area.
- The height above the floor after built-in varies between 200 (7.87) and 500 (19.68) mm (in.).
- A metal rail helps to fix the entry cables.
- Lateral uprights with knock-out auxiliary output with Ø Pg 36 (48 (1.89) mm (in.)).
- A knock-out area is provided at the bottom of the lateral uprights for cable entry, if necessary.
- Material: Polyester reinforced with fiberglass
- Color: RAL 7035 grey

Supply:

Delivered with the fixings required for installation

Note:

For dimensions see [page 234](#)



NSYZHPLA53G

Characteristics	References
Buriable H plinths	NSYZHPLA53G
Buriable H plinths	NSYZHPLA73G
Buriable H plinths	NSYZHPLA103G
Buriable H plinths	NSYZHPLA123G
Buriable H plinths	NSYZHPLA54G
Buriable H plinths	NSYZHPLA74G
Buriable H plinths	NSYZHPLA104G
Buriable H plinths	NSYZHPLA124G

Floor-standing frame

- Frame for direct fixing on the floor for installing open bottom enclosures (version PLAZ or PLAZT).
- Material: Passivated zinc-coated steel

Supply:

Delivered with fixings required for installation

Note:

For dimensions see [page 234](#)



NSYMFPLAZ53

Characteristics	References
Floor-standing frame	NSYMFPLAZ53
Floor-standing frame	NSYMFPLAZ73
Floor-standing frame	NSYMFPLAZ103
Floor-standing frame	NSYMFPLAZ123
Floor-standing frame	NSYMFPLAZ54
Floor-standing frame	NSYMFPLAZ74
Floor-standing frame	NSYMFPLAZ104
Floor-standing frame	NSYMFPLAZ124
Floor-standing frame	NSYMFPLAZ76
Floor-standing frame	NSYMFPLAZ126

Floor-fixing studs



NSYFSP LAZ

- Description: Set of four threaded parts and fixings for fixing the enclosures on concrete plinths.

Characteristics	References
Floor-fixing studs	NSYFSP LAZ

Internal door

- Designed for direct installation in enclosures with sealed bottom part. In the enclosures with the bottom part open, installation can be
- Performed by ordering the necessary adapter plates, ref. **NSYPTZ●●●●**.
- Two depthwise mounting positions (two positions for depthwise installation) according to the chosen M8 impressions, on the top and bottom parts of the enclosure, for fixing.
- Lock with 5 (0.20) mm (in.) double-bar inserts.
- Not compatible with: Modular distribution chassis, 19" chassis, cable entry plate and door retainer, ref. **NSYRETPLAU**.
- Material: Aluminum
- Color: RAL 7035 grey

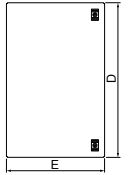

Supply:
Delivered with M8 brass inserts and fixings

Note:
For dimensions see [page 234](#)



Dimensions		Internal door dimensions		References
Height mm (in.)	Width mm (in.)	D mm (in.)	E mm (in.)	
500 (19.68)	500 (19.68)	398 (15.67)	398 (15.67)	NSYPAPLA55G
500 (19.68)	750 (29.53)	398 (15.67)	648 (25.51)	NSYPAPLA57G
500 (19.68)	1000 (39.37)	398 (15.67)	796 (31.34) (2 x 398 (15.67))	2 x NSYPAPLA55G
500 (19.68)	1250 (49.21)	398 (15.67)	1046 (41.18) (398 (15.67) + 648 (25.51))	NSYPAPLA55G + NSYPAPLA57G
750 (29.53)	500 (19.68)	648 (25.51)	398 (15.67)	NSYPAPLA75G
750 (29.53)	750 (29.53)	648 (25.51)	648 (25.51)	NSYPAPLA77G
750 (29.53)	1000 (39.37)	648 (25.51)	796 (31.34) (2 x 398 (15.67))	2 x NSYPAPLA75G
750 (29.53)	1250 (49.21)	648 (25.51)	1046 (41.18) (398 (15.67) + 648 (25.51))	NSYPAPLA75G + NSYPAPLA77G
1000 (39.37)	500 (19.68)	898 (35.35)	398 (15.67)	NSYPAPLA105G
1000 (39.37)	750 (29.53)	898 (35.35)	648 (25.51)	NSYPAPLA107G
1000 (39.37)	1000 (39.37)	898 (35.35)	796 (31.34) (2 x 398 (15.67))	2 x NSYPAPLA105G
1000 (39.37)	1250 (49.21)	898 (35.35)	1046 (41.18) (398 (15.67) + 648 (25.51))	NSYPAPLA105G + NSYPAPLA107G
1250 (49.21)	500 (19.68)	1148 (45.20)	398 (15.67)	NSYPAPLA125G
1250 (49.21)	750 (29.53)	1148 (45.20)	648 (25.51)	NSYPAPLA127G
1250 (49.21)	1000 (39.37)	1148 (45.20)	796 (31.34) (2 x 398 (15.67))	2 x NSYPAPLA125G
1250 (49.21)	1250 (49.21)	1148 (45.20)	1046 (41.18) (398 (15.67) + 648 (25.51))	NSYPAPLA125G + NSYPAPLA127G
1500 (59.06)	500 (19.68)	1398 (55.04)	398 (15.67)	NSYPAPLA155G
1500 (59.06)	750 (29.53)	1398 (55.04)	648 (25.51)	NSYPAPLA157G
1500 (59.06)	1000 (39.37)	1398 (55.04)	796 (31.34) (2 x 398 (15.67))	2 x NSYPAPLA155G
1500 (59.06)	1250 (49.21)	1398 (55.04)	1046 (41.18) (398 (15.67) + 648 (25.51))	NSYPAPLA155G + NSYPAPLA157G

Door retainer

- Designed to adapt directly to the enclosure
- Can be installed on a door opening to the left or right indistinctly
- Material: Galvanized steel

Supply:
Delivered with the fixings required for installation

Note:
ref. **NSYRETPLAU** is incompatible with internal doors, modular distribution chassis, step slides, adapter plates and cable entry plates. If not compatible, use ref. **NSYRETPLA**.

Characteristics	References
Door retainer, PLA, PLAZ, PLAT versions, opening to 110°	NSYRETPLA
Door retainer, PLA, PLAZ, PLAT, PLAZT versions*, with 2 positions, 90° and 120°	NSYRETPLAU



Door switch

- NC + NO switch.
- Incompatible with the rear door and modular distribution chassis

Supply:
Switch, fixing bracket and fixings

Characteristics	References
Door switch	NSYSNLPLA



Lock with handle

- Ergonomic locking system with pivoting handle installed as standard on enclosures with ventilated canopy and/or open bottom part, with a 5 (0.20) mm (in.) double-bar insert block.
- Material: PA6
- Color: RAL 7035 grey

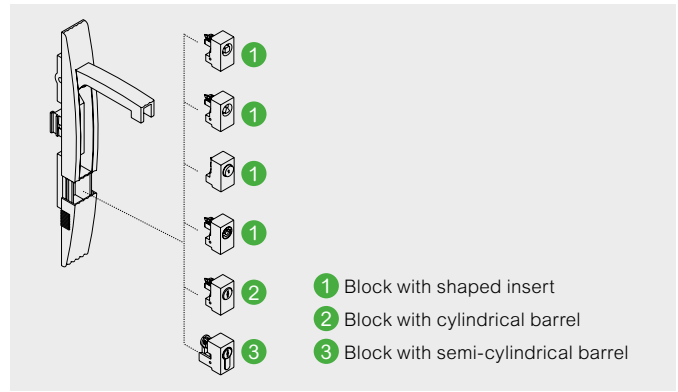

Options for converting the form-insert blocks

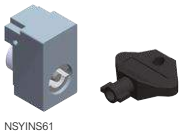

Characteristics	References
6 (0.24) mm (in.) square insert	NSYINS61
7 (0.28) mm (in.) square insert	NSYINS71
8 (0.32) mm (in.) square insert	NSYINS81
6.5 (0.26) mm (in.) triangular insert	NSYINT61
8 (0.32) mm (in.) triangular insert	NSYINT81
Push-button	NSYTSPLA
Double-bar	NSYINDB51

Options for converting the blocks to cylindrical barrels

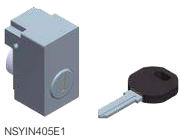

Characteristics	References
405E key lock	NSYIN405E1
421E key lock	NSYIN421E1
455 key lock	NSYIN4551
1242E key lock	NSYIN1242E1
1332E key lock	NSYIN1332E1
2124E key lock	NSYIN2124E1
2131A key lock	NSYIN2131A1
2132A key lock	NSYIN2132A1
2331A key lock	NSYIN2331A1
2433A key lock	NSYIN2433A1
2452E key lock	NSYIN2452E1
3113A key lock	NSYIN3113A1
3122E key lock	NSYIN3122E1
3123A key lock	NSYIN3123A1
3131A1 key lock	NSYIN3131A1
3133A key lock	NSYIN3133A1
3422E key lock	NSYIN3422E1
3432E key lock	NSYIN3432E1
6101 key lock	NSYIN6101

Options for converting the blocks to semi-cylindrical barrels



Characteristics	References
Spacial SF/SM 1242E key lock	NSYIN1242E2
Spacial SF/SM Adapter for DIN cylinder	NSYINDIN2
Spacial SF/SM JIS key lock	NSYINKJIS2
Spacial SF/SM Reinforced key lock	NSYINKR2
Spacial SF/SM FAC key lock	NSYINKFAC2

Options for converting the handle lock

- Changing the handle for a handle including a padlocking device (Ø 10 (0.39) mm (in.)) allowing the handle to be locked. The handle is delivered without barrel or insert block.



NSYBCMPLAG

Characteristics	References
Options for converting the handle lock	NSYBCMPLAG

Options for converting the handle lock

- Spare handle lock without barrel or insert blocks. The insert or barrel are to be chosen from the option table.



NSYEBMPLAG

Characteristics	References
Options for converting the handle lock	NSYEBMPLAG



NSYLDDB5

NSYLC8

NSYLT8

Type of lock	Insert references	Key references
5 (0.20) mm (in.) double-bar	NSYTDB5PLA	NSYLDDB5
6 (0.24) mm (in.) □	NSYTC6CRN	NSYLC7
7 (0.28) mm (in.) □	NSYTC7CRN	NSYLC7
8 (0.32) mm (in.) □	NSYTC8CRN	NSYLC8
6.5 (0.26) mm (in.) ▲	NSYTT6CRN	NSYLT8
7 (0.28) mm (in.) ▲	NSYTT7CRN	NSYLT8
8 (0.32) mm (in.) ▲	NSYTT8CRN	NSYLT8

19" fixed chassis

Installation: For heights from 750 (29.53) to 1500 (59.06) mm (in.), the installation requires ordering one set of two matching uprights. If a chassis is installed in an enclosure with a greater height, it is necessary to use the suitable uprights for the size of the enclosure

- Very sturdy 19" metal chassis, designed for installation in enclosures with a width of 750 (29.53) and 1250 (49.21) mm (in.). In the 1250 (49.21) mm (in.) enclosures width, the chassis is installed in the 750 (29.53) mm (in.) part with an intermediate support, ref. **NSYSBPLA**.
- These chassis can be used as partial mounted plates in enclosures with a height greater than the nominal height.
- Incompatible with the internal doors and the step slides.
- Fixed chassis made up of two uprights with fixings
- Material: Galvanized steel
- Finish: Epoxy polyester paint
- Color: RAL 7035 grey
- Maximum load: 3 (6.61) kg (lbs.) per unit

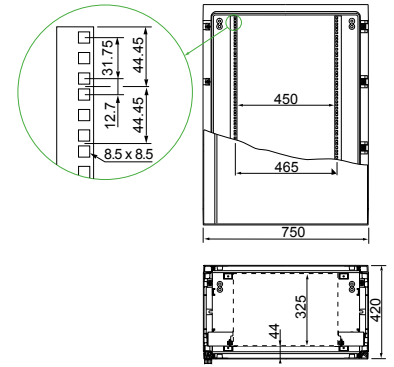

Note:
For dimensions see [page 237](#)



NSYBRF8PLAG

Characteristics	Height mm (in.)	Width mm (in.)	# of units	References
19" fixed chassis	500 (19.68)	750 (29.53)	8	NSYBRF8PLAG
19" fixed chassis	750 (29.53)	750 (29.53)	12	NSYBRF12PLAG
19" fixed chassis	1000 (39.37)	750 (29.53)	17	NSYBRF17PLAG
19" fixed chassis	1250 (49.21)	750 (29.53)	21	NSYBRF21PLAG
19" fixed chassis	1500 (59.06)	750 (29.53)	26	NSYBRF26PLAG
19" fixed chassis	2000 (78.74)	750 (29.53)	2 x 17	2 x NSYBRF17PLAG + NSYPTZ4
Set of two uprights	750 (29.53)	750 (29.53)	12	NSYSPLA75
Set of two uprights	1000 (39.37)	750 (29.53)	17	NSYSPLA100
Set of two uprights	1250 (49.21)	750 (29.53)	21	NSYSPLA125
Set of two uprights	1500 (59.06)	750 (29.53)	26	NSYSPLA150*
Set of two uprights	2000 (78.74)	750 (29.53)	2 x 17	2 x NSYSPLA100

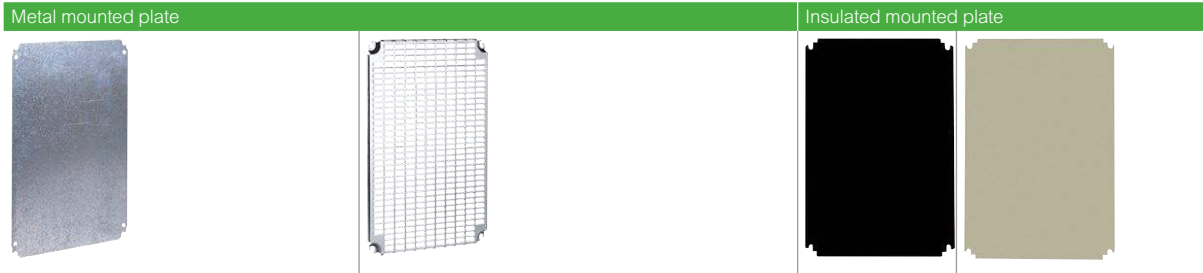

* Not compatible with **NSYCAAPVHD**.



Note:
For dimensions see [page 235](#)

Characteristics	Metal mounted plate				Insulated mounted plate							
	Plain mounted plate		Telequick mounted plate		Bakelite		Polyester					
Characteristics	<ul style="list-style-type: none"> Direct installation on M8 inserts at the rear of the enclosure or on step slides for depth adjustment (see page 230). The enclosures with height of ≥ 1000 (39.37) mm (in.) have intermediate impressions for installing mounted plates of a lesser height (M8 inserts, ref. NSYTEX8, to be ordered separately). In the two door enclosures, it is possible to install one complete mounted plate or two individual mounted plates. 				<ul style="list-style-type: none"> Grille with 11 (0.43) x 26 (1.02) mm (in.) drill holes, with a step of 15 (0.59) x 30 (1.18) mm (in.), for direct installation, with clip nuts, of all the devices with fixing at 2, 3 or 4 points, by screws with diameters of 3 (0.12), 4 (0.16), 5 (0.20) or 6 (0.24) mm (in.). Direct installation on M8 inserts at the rear of the enclosure or on step slides for depth adjustment (see page 230). The enclosures with height of ≥ 1000 (39.37) mm (in.) have intermediate impressions for installing mounted plates of a lesser height (M8 inserts, ref. NSYTEX8, to be ordered separately). 				<ul style="list-style-type: none"> Direct installation on M8 inserts at the rear of the enclosure or on step slides for depth adjustment (see page 230). The enclosures with height of ≥ 1000 (39.37) mm (in.) have intermediate impressions for installing mounted plates of a lesser height (M8 inserts, ref. NSYTEX8, to be ordered separately). In the two door enclosures, it is possible to install one complete mounted plate or two individual mounted plates. 			
Material	Galvanized sheet steel				Galvanized steel				Bakelite	Polyester		
Finish	-				-				-	-		
Color	-				-				-	-		
Thickness	2.5 (0.10) mm (in.)				-				4 (0.16) mm (in.)	<ul style="list-style-type: none"> 4 (0.16) mm (in.) up to 700 (27.56) mm (in.) height 5 (0.20) mm (in.) from 800 (31.50) mm (in.) height 		
Maximum load	150 (330.69) kg (lbs.)/m ²				150 (330.69) kg (lbs.)/m ²				100 (220.46) kg (lbs.)/m ²	100 (220.46) kg (lbs.)/m ²		
Supply	One mounted plate				One mounted plate				One mounted plate	One mounted plate		
Dimensions					Dimensions							
Height (A) mm (in.)	Width (B) mm (in.)	H mm (in.)	Surface (dm ²)	References	E mm (in.)	D mm (in.)	Surface (dm ²)	References	References	References		
500 (19.68)	500 (19.68)	-	14	NSYPMM55	350 (13.78)	350 (13.78)	13	NSYPMR55	NSYPMB55	NSYPMA55		
500 (19.68)	750 (29.53)	-	24	NSYPMM75	350 (13.78)	600 (23.62)	23	NSYPMR57	NSYPMB75	NSYPMA75		
500 (19.68)	1000 (39.37)	437.5 (17.22)	32	NSYPMM510	350 (13.78)	2 x 350 (13.78)	26	2 x NSYPMR55	NSYPMB510	NSYPMA510		
500 (19.68)	1250 (49.21)	-	38	NSYPMM55 + NSYPMM75	350 (13.78)	350 (13.78) + 600 (23.62)	36	NSYPMR55 + NSYPMR57	NSYPMB55 + NSYPMB75	NSYPMA55 + NSYPMA75		
750 (29.53)	500 (19.68)	-	24	NSYPMM75	600 (23.62)	350 (13.78)	23	NSYPMR75	NSYPMB75	NSYPMA75		
750 (29.53)	750 (29.53)	-	40	NSYPMM77	600 (23.62)	600 (23.62)	38	NSYPMR77	NSYPMB77	NSYPMA77		
750 (29.53)	1000 (39.37)	437.5 (17.22)	54	NSYPMM710	600 (23.62)	2 x 350 (13.78)	46	2 x NSYPMR75	NSYPMB710	NSYPMA710		
750 (29.53)	1250 (49.21)	687.5 (27.07)	70	NSYPMM712	600 (23.62)	350 (13.78) + 600 (23.62)	61	NSYPMR75 + NSYPMR77	NSYPMB712	NSYPMA712		
1000 (39.37)	500 (19.68)	-	33	NSYPMM105	850 (33.46)	350 (13.78)	32	NSYPMR105	NSYPMB105	NSYPMA105		
1000 (39.37)	750 (29.53)	-	55	NSYPMM107	850 (33.46)	600 (23.62)	54	NSYPMR107	NSYPMB107	NSYPMA107		
1000 (39.37)	1000 (39.37)	437.5 (17.22)	74	NSYPMM1010	850 (33.46)	2 x 350 (13.78)	64	2 x NSYPMR105	NSYPMB1010	NSYPMA1010		
1000 (39.37)	1250 (49.21)	687.5 (27.07)	96	NSYPMM1012	850 (33.46)	350 (13.78) + 600 (23.62)	86	NSYPMR105 + NSYPMR107	NSYPMB1012	NSYPMA1012		
1250 (49.21)	500 (19.68)	-	42	NSYPMM125	1100 (43.31)	350 (13.78)	42	NSYPMR125	NSYPMB125	NSYPMA125		
1250 (49.21)	750 (29.53)	-	70	NSYPMM127	1100 (43.31)	600 (23.62)	70	NSYPMR127	NSYPMB127	NSYPMA127		
1250 (49.21)	1000 (39.37)	437.5 (17.22)	96	NSYPMM1210	1100 (43.31)	2 x 350 (13.78)	84	2 x NSYPMR125	NSYPMB1210	NSYPMA1210		
1250 (49.21)	1250 (49.21)	687.5 (27.07)	124	NSYPMM1212	1100 (43.31)	350 (13.78) + 600 (23.62)	112	NSYPMR125 + NSYPMR127	NSYPMB1212	NSYPMA1212		
1500 (59.06)	500 (19.68)	-	51	NSYPMM155	1350 (53.15)	350 (13.78)	51	NSYPMR155	NSYPMB155	-		
1500 (59.06)	750 (29.53)	-	85	NSYPMM157	1350 (53.15)	600 (23.62)	85	NSYPMR157	NSYPMB157	-		
1500 (59.06)	1000 (39.37)	437.5 (17.22)	118	NSYPMM1510	1350 (53.15)	2 x 350 (13.78)	102	2 x NSYPMR155	NSYPMB1510	-		
1500 (59.06)	1250 (49.21)	687.5 (27.07)	152	NSYPMM1512	1350 (53.15)	350 (13.78) + 600 (23.62)	136	NSYPMR155 + NSYPMR157	NSYPMB1512	-		
2000 (78.74)	750 (29.53)	-	115	NSYPMM207	2 x 850 (33.46)	2 x 600 (23.62)	108	2 x NSYPMR107	2 x NSYPMB107	2 x NSYPMA107		

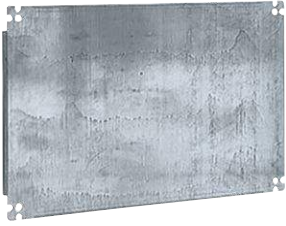
Technical changes reserved. Information provided without guarantee. Images are for illustrative purposes only.

Partial plain mounted plate		Technical uprights		Anti burglary accessory	
					
<ul style="list-style-type: none"> Direct fixing on the uprights with the notched sliding nuts or pivoting nuts, see common accessories section. 		<ul style="list-style-type: none"> Supports for fixing rails, perforated grilles and plain partial mounted plates. Details in the common accessory section. Fixing at the rear on the M8 inserts or on the step slides. 		<ul style="list-style-type: none"> Anti burglary accessory for polyester outdoor heavy-duty enclosure in accordance with ENV 1627-1630:2011 Class II. It keeps the Insulation Class II according to IEC 61439-1:2011. 	
Galvanized sheet steel		Zinc-coated steel		Steel with anti-corrosive coating	
-		-		Structured finish, 100% polyester powder	
-		-		RAL 7035 grey	
2.5 (0.10) mm (in.)		2 (0.08) mm (in.)		-	
150 (330.69) kg (lbs.)/m ²					
One mounted plate		Two technical uprights		One anti burglary frame	
Height 247 (9.72) mm (in.) (H)	Height 397 (15.63) mm (in.) (H)			Depth 420 (16.54) mm (in.)	Depth 620 (24.41) mm (in.)
References	References	Dimensions mm (in.)	References	References	References
-	-	-	-	-	-
NSYSPMP2575	-	-	-	-	-
NSYSPMP25100	NSYSPMP40100	-	-	-	-
-	-	-	-	-	-
-	-	625 (24.61)	NSYTVR7	-	-
NSYSPMP2575	-	625 (24.61)	NSYTVR7	NSYBGN774HD	NSYBGN776HD
NSYSPMP25100	NSYSPMP40100	625 (24.61)	NSYTVR7	-	-
-	-	625 (24.61)	NSYTVR7	-	-
-	-	875 (34.45)	NSYTVR10	NSYBGN1054HD	-
NSYSPMP2575	-	875 (34.45)	NSYTVR10	NSYBGN1074HD	-
NSYSPMP25100	NSYSPMP40100	875 (34.45)	NSYTVR10	-	-
-	-	875 (34.45)	NSYTVR10	-	-
-	-	1125 (44.29)	NSYTVR125	NSYBGN1254HD	-
NSYSPMP2575	-	1125 (44.29)	NSYTVR125	NSYBGN1274HD	NSYBGN1276HD
NSYSPMP25100	NSYSPMP40100	1125 (44.29)	NSYTVR125	-	-
-	-	1125 (44.29)	NSYTVR125	NSYBGN12124HD	NSYBGN12126HD
-	-	1375 (54.13)	NSYTVR15	-	-
NSYSPMP2575	-	1375 (54.13)	NSYTVR15	NSYBGN1574HD	NSYBGN1576HD
NSYSPMP25100	NSYSPMP40100	1375 (54.13)	NSYTVR15	-	-
-	-	1375 (54.13)	NSYTVR15	NSYBGN15124HD	NSYBGN15126HD
NSYSPMP2575	-	1875 (73.82)	2 x NSYTVR10	NSYBGN2074HD	-
		Note: Enclosures with widths of 1000 (39.37) and 1250 (49.21) mm (in.) allow the installation of four uprights to integrate two mounted plates of 500 (19.68) or of 500 (19.68) and 750 (29.53) mm (in.).			

Step slides

- Set of four step slides with brackets allowing continuous depth adjustment of the mounted plate, with a pitch of 25 (0.98) mm (in.).
- Designed for direct installation in the enclosures with sealed bottom part (versions PLA or PLAT).
- In the enclosures with open bottom part (versions PLAZ or PLAZT), installation is made possible by adding the relevant adapter plates.
- Incompatibility with: Internal door, modular distribution chassis, 19" chassis, cable entry plate and door retainer, ref. **NSYRETPLAU**.
- Material: Bracket with steel M8 stud on aluminum rail
- Fixing: Fixing on the top and bottom parts of the enclosure by means of M8 inserts and screws (supplied)



Note:
For dimensions see [page 235](#)



NSYDPLA3

Characteristics	Depth mm (in.)	No. of doors	References
Step slides	320 (12.60)	1	NSYDPLA3
Step slides	320 (12.60)	2	2 x NSYDPLA3
Step slides	420 (16.54)	1	NSYDPLA4
Step slides	420 (16.54)	2	2 x NSYDPLA4
Step slides	620 (24.41)	1	NSYDPLA6
Step slides	620 (24.41)	2	2 x NSYDPLA6

Adapter plates

- The enclosures with open bottom part (versions PLAZ and PLAZT) require a set of adapter plates for mounting: An internal door, step slides, modular chassis and 19" chassis.
- **NSYPTZ●●●** for one door enclosures
- **NSYPTX●●● 2P** for two door enclosures
- Material: Galvanized steel
- Fixing: Fixing on the bottom part of the enclosure by means of M8 inserts and screws (supplied)



NSYPTZ3

Characteristics	Depth mm (in.)	No. of doors	References
Adapter plates	320 (12.60)	1	NSYPTZ3
Adapter plates	320 (12.60)	2	NSYPTZ32P
Adapter plates	420 (16.54)	1	NSYPTZ4
Adapter plates	420 (16.54)	2	NSYPTZ42P
Adapter plates	620 (24.41)	1	NSYPTZ6
Adapter plates	620 (24.41)	2	NSYPTZ62P

Additional support

- Set of four additional brackets, to be slid into the step slides, for the installation of an additional mounted plate.



NSYEDPLA

Characteristics	Reference
Additional support	NSYEDPLA

9

Plain cover plate

- Plain cover plate for non modular switchgear protection.
- Can be cutted out according to needs.
- Material: Polystyrene (PS) (for 146 (5.75) mm (in.) high)
- Fiberglass reinforced polyester (for 298 (11.73) mm (in.) high)
- Color: RAL 7035 grey

Supply:
Order by multiples of 2 (2, 4, 6...)

Note:
Dimensions, [page 236](#)



NSYCTL500DLPG

Characteristics	References
Plain cover plate	NSYCTL500DLPG
Plain cover plate	NSYCTL500DLP2
Plain cover plate	NSYCTL750DLPG
Plain cover plate	NSYCTL750DLP2

Plain mounted plate

- Plate for fixing non modular devices.
- Depth-adjustable fixing on the supports from 40 (1.58) to 85 (3.35) mm (in.).
- Material: Galvanized steel 2 (0.08) mm (in.) thick

Supply:
Order by multiples of 2 (2, 4, 6...)

Note:
Dimensions, [page 236](#)

Characteristics	References
Plain mounted plate 146 for width 500	NSYPMP500DLP
Plain mounted plate 298 for width 500	NSYPMP5002DLP
Plain mounted plate 146 for width 750	NSYPMP750DLP
Plain mounted plate 298 for width 750	NSYPMP7502DLP

Technical changes reserved. Information provided without guarantee. Images are for illustrative purposes only.

Support plate



NSYSPLA75

Installation:

It is installed directly on the bottom part of the enclosure.

For the installation of one or several support plates, use two sets of two uprights suitable for the height (to be ordered separately). These uprights offer the option of adjusting the height with a step of 50 (1.97) mm (in.)

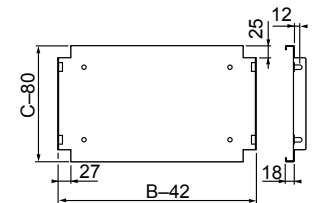
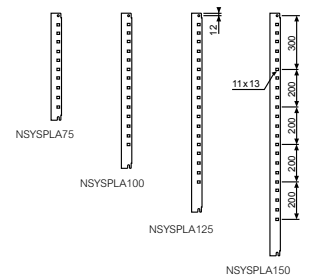

- Designed to support assorted equipment or simply to install a separation.
- In the two door enclosures, the installation of the plate or the uprights requires the prior installation of an intermediate support, ref. **NSYSBPLA**, presented beside.
- Material: Galvanized steel

Supply:

Delivered with the fixings required for installation

Height	Depth	Upright No. of adjustments	References
750 (29.53)	320 (12.60) / 420 (16.54)	2	2 x NSYSPLA75
1000 (39.37)	320 (12.60) / 420 (16.54)	3	2 x NSYSPLA100
1250 (49.21)	320 (12.60) / 420 (16.54)	4	2 x NSYSPLA125
1500 (59.06)	–	5	2 x NSYSPLA150
2000 (78.74)	420 420 (16.54)	6	2 x NSYSPLA100

Depth (C)	Width (B)	Plate Max. load kg (lbs.)	References
320 (12.60)	500 (19.68)	60 (132.28)	NSYBANPLA53
320 (12.60)	750 (29.53)	60 (132.28)	NSYBANPLA73
420 (16.54)	500 (19.68)	50 (110.23)	NSYBANPLA54
420 (16.54)	750 (29.53)	50 (110.23)	NSYBANPLA74
620 (24.41)	500 (19.68)	50 (110.23)	NSYBANPLA56*
620 (24.41)	750 (29.53)	50 (110.23)	NSYBANPLA76

*Designed for PLA enclosures of 1250 (49.21) mm (in.) width and 620 (24.41) mm (in.) depth.

M8 inserts



NSYTEX8

- To be placed in the bosses molded on the doors, uprights, rear panels and bottom and top parts, for fixing accessories and assorted devices.
- Material: Brass

Supply:

References by unit. Order by multiples of 8 units (8, 16, 24, etc.)

Characteristics	References
Fixing inserts	NSYTEX8

Intermediate support in the two door enclosures



NSYSBPLA

- Required accessory for installing support plates, ref. **NSYBANPLA●●●** or uprights, ref. **NSYSPLA●●●** in the two door enclosures
- Material: Galvanized steel

Supply:

Two support kits

Characteristics	References
Intermediate support in the two door enclosures	NSYSBPLA

Recommendation

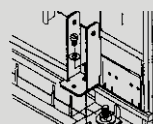

Intermediate support

Accessory required for installing uprights, ref. **NSYSPLA●●●**. Only for two door enclosures.
Supply: one (including two supports) ref. **NSYSBPLA**

Sealed enclosure or enclosure with ventilated canopy

For enclosures without canopy, please just disregard the related 38 (1.50) mm (in.).

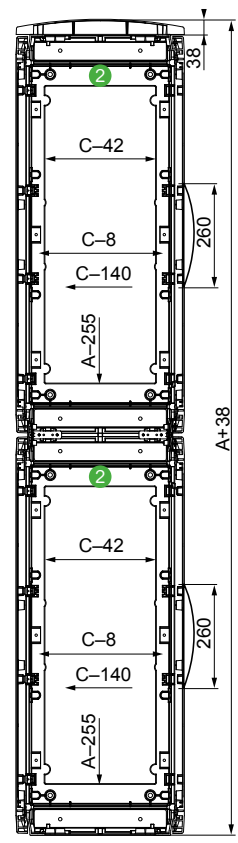
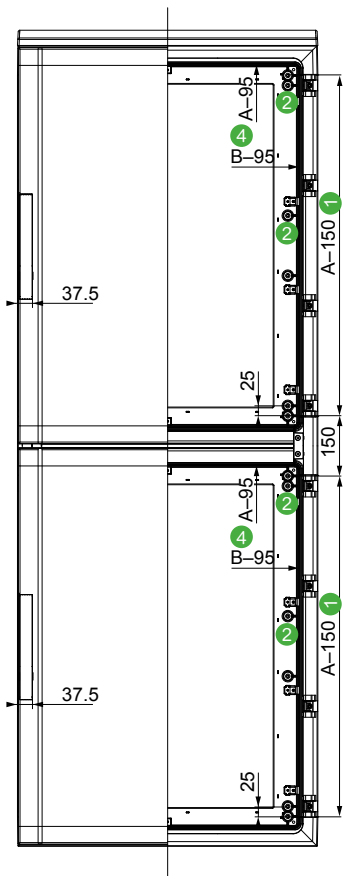
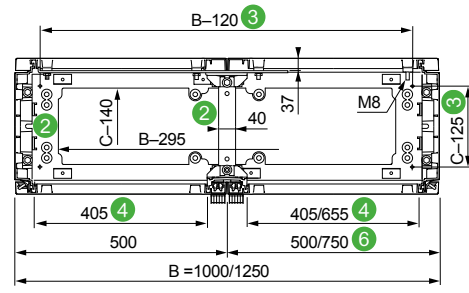
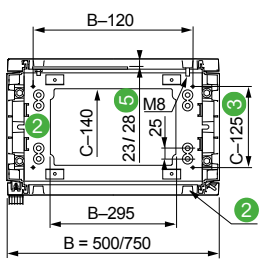
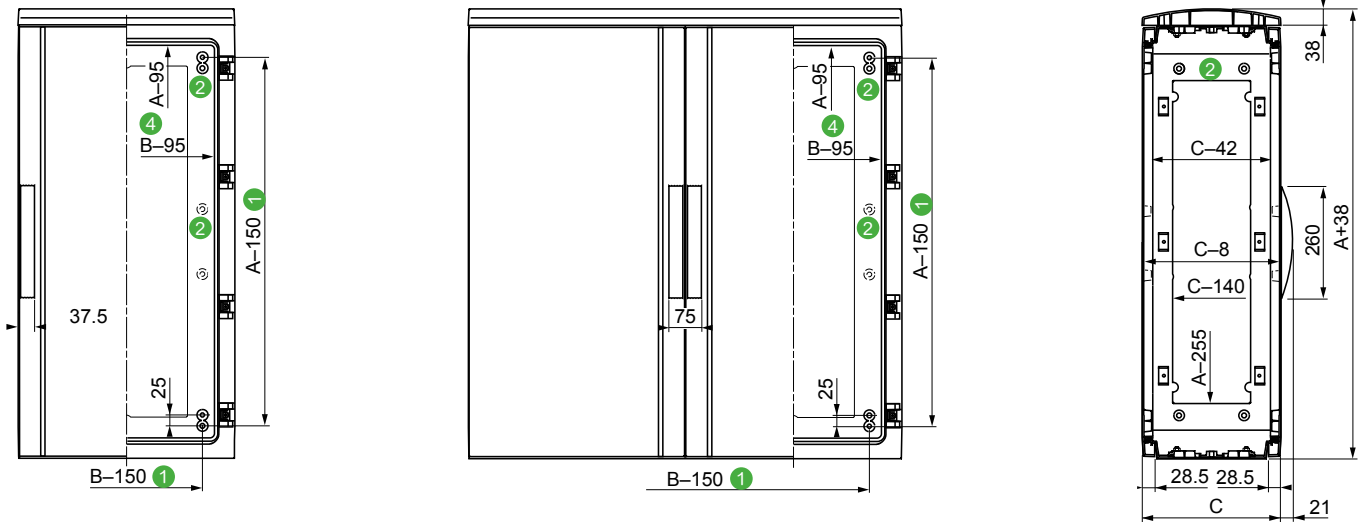

- 1 4 bosses with M8 inserts and studs for direct fixing of mounted plates.
- 2 Bosses designed to accommodate M8 inserts, ref. **NSYTEX8**. They are placed:
 - On the back of the enclosure, from the height of 1000 (39.37) mm (in.). They allow the fixing of partial mounted plates and assorted equipment.
 - On the top and bottom parts of the enclosure. They are used for fixing the step slides, an internal door, 19" chassis, etc.
- 3 Dimensions for fixing on the floor or on a plinth.
- 4 Entry dimensions, door open.
- 5 Dimension of 28 (1.10) mm (in.) for enclosures with heights of more than 1000 (39.37) mm (in.) (height after the installation of the plain mounted plates with reinforcement foldings).
- 6 With a width of 1250 (49.21) mm (in.) in standard supply, 500 (19.68) mm (in.) door on the left and 750 (29.53) mm (in.) door on the right.

Technical changes reserved. Information provided without guarantee. Images are for illustrative purposes only.

1

For enclosures without canopy, please just disregard the related 38 (1.50) mm (in.)



Connectors between plinths

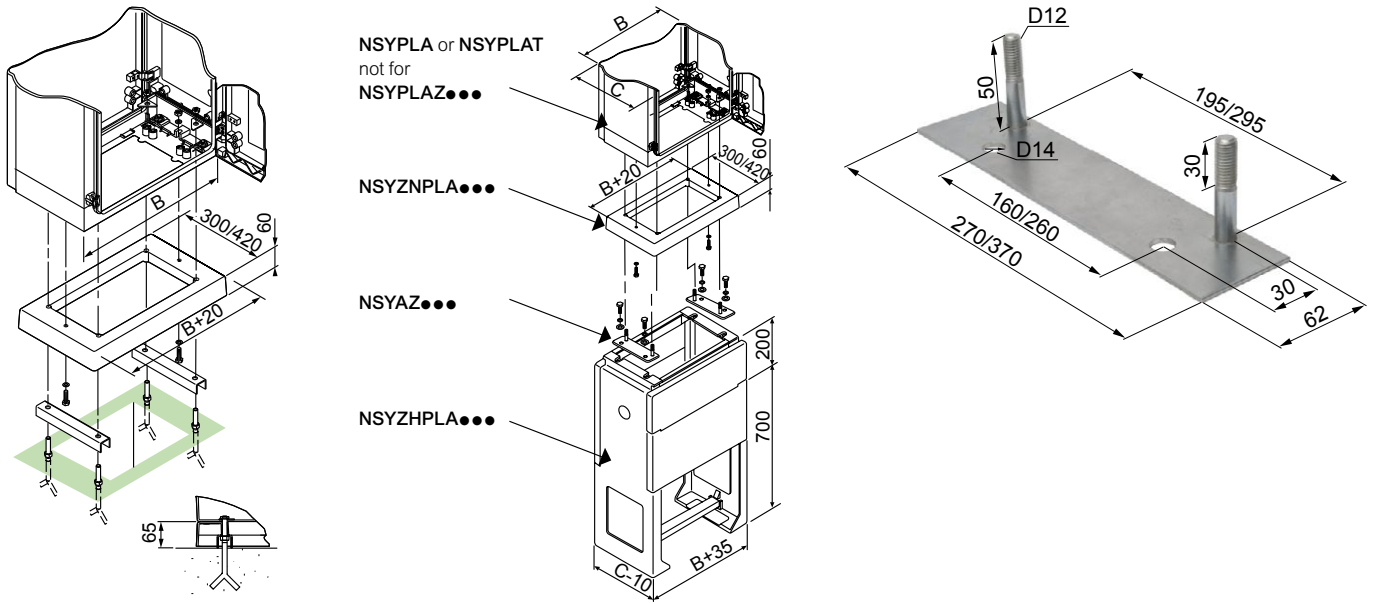

H-plinths for partially buried installation

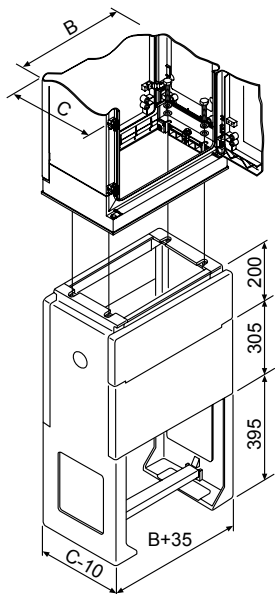

Floor-standing frame

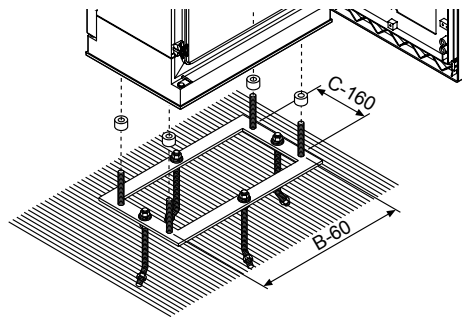

9

Internal door

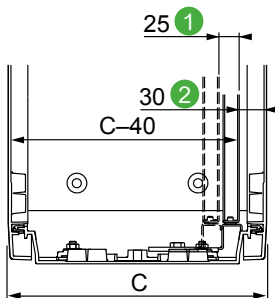

- ① Two positions for depthwise installation
- ② The 2nd position moves the position of the internal door back by 25 (0.98) mm (in.)

Plain mounted plate

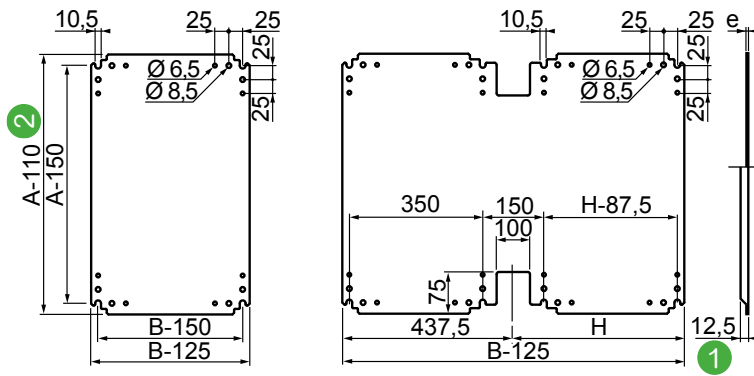

Telequick mounted plate

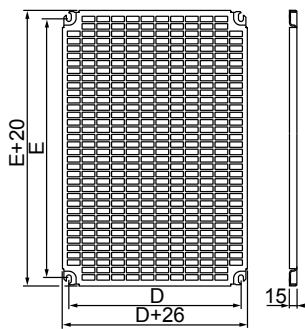

Insulated mounted plate

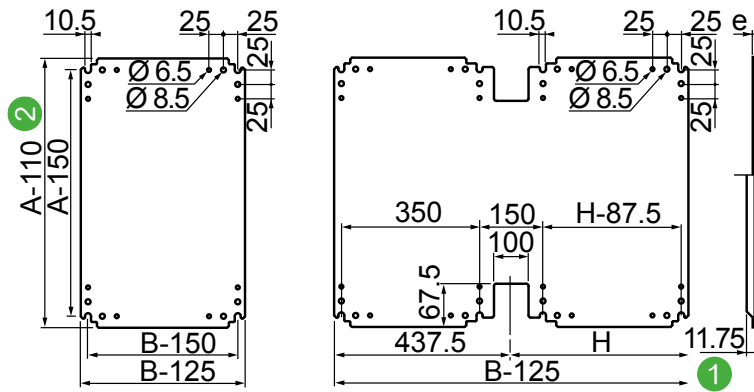

- ① Reinforcing fold for steel mounted plate NSYPMM1010 to NSYPMM1512
- ② A-125 for references NSYPMM1010 to NSYPMM1512, A-120 for the polyester mounted plate, ref. NSYPMA●●●.

Step slides

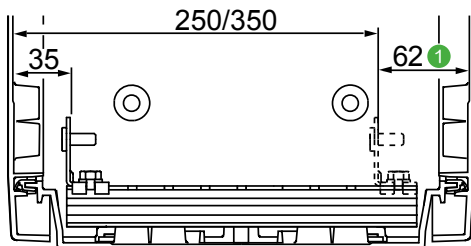

Installation of step slide ref. NSYDPLA●●●,
① 57 (2.24) mm (in.) with one transparent door.

Step slides

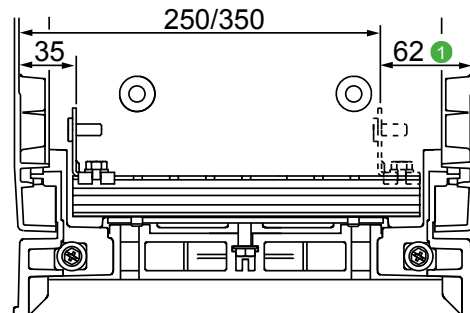

Installation of step slide ref. NSYDPLA●●●, with adapter plate
ref. NSYPTZ●●●, ① 57 (2.24) mm (in.) with one transparent door.

Upright

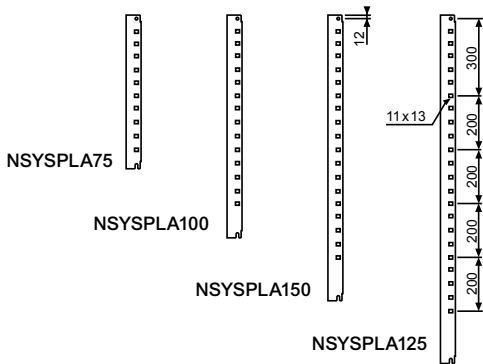

Plate

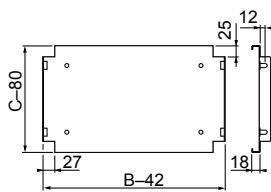

Plain cover plate

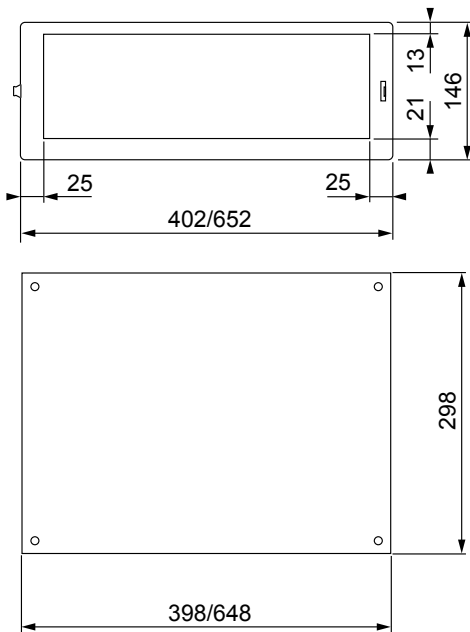

For enclosure	Height	Thickness	References
Width mm (in.)	A mm (in.)	mm (in.)	
500 (19.68)	146 (5.75)	2 (0.08)	NSYCTL500DLPG
500 (19.68)	298 (11.73)	4 (0.16)	NSYCTL500DLP2
750 (29.53)	146 (5.75)	2 (0.08)	NSYCTL750DLPG
750 (29.53)	298 (11.73)	4 (0.16)	NSYCTL750DLP2

Plain mounted plate

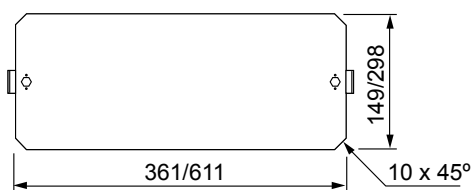

For enclosure	Height	Thickness	References
Width mm (in.)	A mm (in.)	mm (in.)	
500 (19.68)	149 (5.87)	2 (0.08)	NSYPMP500DLP
500 (19.68)	298 (11.73)	2 (0.08)	NSYPMP500DLP2
750 (29.53)	149 (5.87)	2 (0.08)	NSYPMP750DLP
750 (29.53)	298 (11.73)	2 (0.08)	NSYPMP750DLP2

Polyester Floor-Standing Enclosures

Thalassa PLA Dimensions

19" fixed chassis

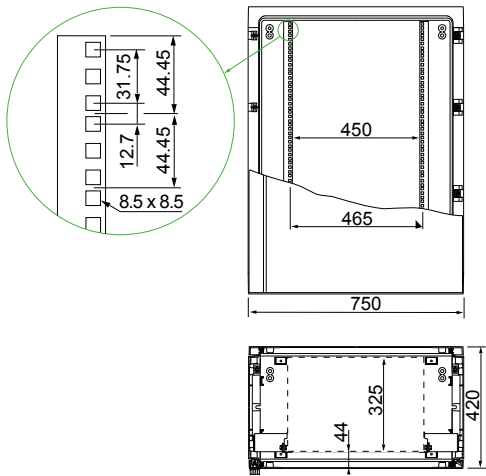

19" swing chassis

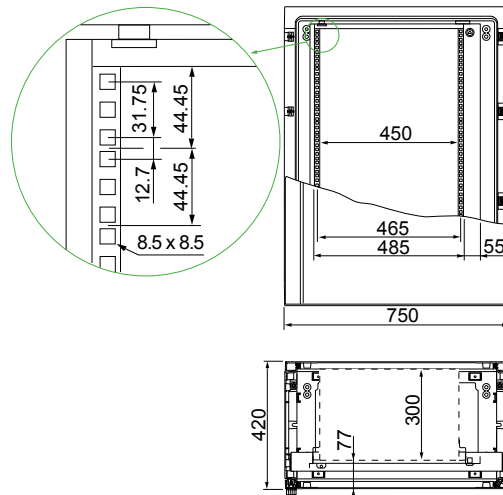

Accessories

Mounting



Cable management

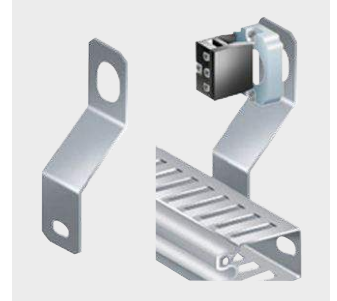

Lighting and power sockets



Floor accessories



Door accessories



Other accessories

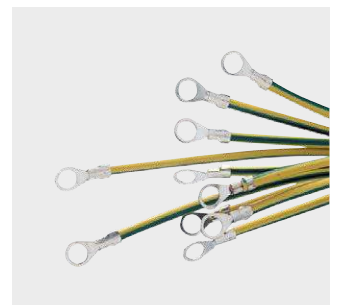

Content

Mounting	240
Cable management	272
Lighting and power sockets	294
Floor accessories	297
Door accessories	298
Other accessories	303
Dimensions	304

Mounting Plates for Wall-Mounted Enclosures

Accessories - Mounting

- S3D
- S3X
- PLM



Characteristics	Mounting plates, plain	Mounting plates, silkscreened	Mounting plates, microperforated**	Telequick Mounting plate**
	-	Silkscreened for easier distribution of the products to be installed. Centimetric grid pattern.	They considerably reduce products installation time thanks to the holes prepared to receive the self-tapping screws. Holes with Ø 3.6 (0.14) in steps of 12.5 (0.49) mm (in.).	They allow cable guides and ducting and other installation accessories to be clipped on, making it easier to install switchgear. 11 (0.43) mm (in.) x 26 (1.02) mm (in.) slots. Switchgear fixing by clip-on nuts.
Material	Galvanized steel	Galvanized steel	Galvanized steel	Zinc-coated steel
Maximum load	PLM: 150 (330.69) kg (lbs.)/m ² S3D, S3X, CRN, CRNG: 250 (551.16) kg (lbs.)/m ²			PLM: 150 (330.69) kg (lbs.)/m ² S3D, S3X, CRN: 250 (551.16) kg (lbs.)/m ²
Supply	One mounting plate without fixing elements			One mounting plate without fixing elements

For enclosures mm (in.)		Dimensions mm (in.)		References	References	References	No. of perforations in		References
Height	Width	H	W				H	W	
200 (7.87)	200 (7.87)	150 (5.91)	150 (5.91)	NSYMM22	-	-	-	-	-
200 (7.87)	300 (11.81)	150 (5.91)	250 (9.84)	NSYMM23	-	-	-	-	-
250 (9.84)	200 (7.87)	200 (7.87)	150 (5.91)	NSYMM2520	-	-	-	-	-
250 (9.84)	300 (11.81)	250 (9.84)	200 (7.87)	NSYMM3025	-	-	-	-	-
250 (9.84)	400 (15.75)	200 (7.87)	350 (13.78)	NSYMM2540	-	-	-	-	-
250 (9.84)	500 (19.68)	200 (7.87)	450 (17.72)	NSYMM2550	-	-	-	-	-
300 (11.81)	200 (7.87)	250 (9.84)	150 (5.91)	NSYMM32	-	NSYMF32	16	5	NSYMR32
300 (11.81)	250 (9.84)	250 (9.84)	200 (7.87)	NSYMM3025*	-	-	16	8	NSYMR3025
300 (11.81)	300 (11.81)	250 (9.84)	250 (9.84)	NSYMM33	-	NSYMF33	16	9	NSYMR33
300 (11.81)	400 (15.75)	250 (9.84)	350 (13.78)	NSYMM43*	NSYMS43*	NSYMF43*	18	11	NSYMR34
300 (11.81)	450 (17.72)	250 (9.84)	400 (15.75)	NSYMM3045	-	-	-	-	-
300 (11.81)	500 (19.68)	450 (17.72)	250 (9.84)	NSYMM53*	-	-	-	-	-
300 (11.81)	600 (23.62)	250 (9.84)	550 (21.65)	NSYMM36	-	-	-	-	-
400 (15.75)	300 (11.81)	230 (9.06)	350 (13.78)	NSYMM43*	NSYMS43	NSYMF43	22	9	NSYMR43
400 (15.75)	400 (15.75)	350 (13.78)	350 (13.78)	NSYMM44	NSYMS44	NSYMF44	24	11	NSYMR44
400 (15.75)	600 (23.62)	350 (13.78)	550 (21.65)	NSYMM64*	NSYMS64*	-	24	19	NSYMR46
400 (15.75)	800 (31.50)	350 (13.78)	750 (29.53)	NSYMM48	-	-	-	-	-
500 (19.68)	300 (11.81)	450 (17.72)	250 (9.84)	NSYMM53*	NSYMS53*	NSYMF53	29	9	NSYMR53
500 (19.68)	400 (15.75)	450 (17.72)	350 (13.78)	NSYMM54	NSYMS54	NSYMF54	31	11	NSYMR54
500 (19.68)	500 (19.68)	450 (17.72)	450 (17.72)	NSYMM55*	NSYMS55*	NSYMF55	31	14	NSYMR55
500 (19.68)	600 (23.62)	550 (21.65)	450 (17.72)	NSYMM65	-	-	-	-	-
600 (23.62)	400 (15.75)	550 (21.65)	350 (13.78)	NSYMM64	NSYMS64	NSYMF64*	38	11	NSYMR64
600 (23.62)	500 (19.68)	550 (21.65)	450 (17.72)	NSYMM65	-	NSYMF65	38	14	NSYMR65
600 (23.62)	600 (23.62)	550 (21.65)	550 (21.65)	NSYMM66	NSYMS66	NSYMF66	38	17	NSYMR66
600 (23.62)	800 (31.50)	-	-	-	-	-	36	24	NSYMR68
700 (27.56)	500 (19.68)	650 (25.59)	450 (17.72)	NSYMM75	NSYMS75	NSYMF75	44	14	NSYMR75
700 (27.56)	600 (23.62)	650 (25.59)	550 (21.65)	NSYMM76	-	-	44	17	NSYMR76
800 (31.50)	600 (23.62)	750 (29.53)	550 (21.65)	NSYMM86*	NSYMS86*	NSYMF86*	51	17	NSYMR86
800 (31.50)	800 (31.50)	750 (29.53)	750 (29.53)	NSYMM88	-	NSYMF88	51	24	NSYMR88
800 (31.50)	1000 (39.37)	-	-	NSYMM108	-	NSYMF108	49	31	NSYMR810
800 (31.50)	1200 (47.24)	-	-	NSYMM128	-	NSYMF128	-	-	2 x NSYMR86
1000 (39.37)	600 (23.62)	950 (37.40)	550 (21.65)	NSYMM106	-	NSYMF106	64	17	NSYMR106
1000 (39.37)	800 (31.50)	950 (37.40)	750 (29.53)	NSYMM108*	-	NSYMF108*	64	24	NSYMR108
1000 (39.37)	1000 (39.37)	950 (37.40)	950 (37.40)	NSYMM1010	-	NSYMF1010	62	31	NSYMR1010
1000 (39.37)	1200 (47.24)	-	-	-	-	-	62	37	NSYMR1012
1200 (47.24)	600 (23.62)	1150 (45.28)	550 (21.65)	NSYMM126	-	NSYMF126	75	17	NSYMR126
1200 (47.24)	800 (31.50)	1150 (45.28)	750 (29.53)	NSYMM128*	-	NSYMF128	75	24	NSYMR128
1200 (47.24)	1000 (39.37)	1150 (45.28)	950 (37.40)	NSYMM1210*	-	NSYMF1210*	75	31	NSYMR1210
1200 (47.24)	1200 (47.24)	1150 (45.28)	1150 (45.28)	NSYMM1212	-	2 x NSYMF126	-	-	2 x NSYMR126
1400 (55.12)	1000 (39.37)	1350 (53.15)	950 (37.40)	NSYMM1410	-	-	88	31	NSYMR1410

* Plate with reversible dimensions; It can be installed in enclosures with inverted dimensions. Example: Plate ref. **NSYMM64** can be used for the following enclosures: H 600 (23.62) x W 400 (15.75) mm (in.) or H 400 (15.75) x W 600 (23.62) mm (in.). For plain and silkscreened mounting plates: In wall-mounted enclosures with widths of 1000 (39.37) and 1200 (47.24) mm (in.), it is possible to install two mounting plates at different depths using an additional central step slide **NSYSDRSDCR...** (more information on [page 243](#)).

** To install two mounting plates in a single enclosure, also order reference **NSYCRNGSDR**. See details on [page 243](#).
To install the plate in an enclosure with six studs, also order reference **NSYEMR**.

	S3D		S3X		PLM																					
Characteristics	Bakelite mounting plate**				Polyester mounting plate**				DIN rail chassis				Joinable Telequick mounting plate													
	<ul style="list-style-type: none"> They are coupled directly to the rear of the actual enclosure or to the sliding plate supports. Double-door enclosures offer the option of installing two plates. 								<ul style="list-style-type: none"> Components supplied with a DIN rail chassis: <ul style="list-style-type: none"> Aluminum uprights. DIN rails (symmetric section A or B, according to the reference). Screws, washers and nuts need to mount the DIN rails to the uprights. Set of four adapters, ref. NSYAMCSF, needed to fix the uprights to the enclosure. 				<ul style="list-style-type: none"> 20 (0.79)/10* mm (in.) Telequick mounting plates. These mounting plates are suitable for mounting vertically multiple plates. 11 (0.43) x 26 (1.02) mm (in.) slots. Switchgear fixing by clip-on nuts. 													
Material	Bakelite				Polyester reinforced with fiberglass				Aluminum or zinc-coated steel				Zinc-coated steel													
Color	RAL 9005 black				RAL 7035 grey				-				-													
Maximum load	100 (220.46) kg (lbs.)/m ²				150 (330.69) kg (lbs.)/m ²				-				-													
Supply	One mounting plate without fixing elements								One DIN rail chassis				One mounting plate and fixing elements													
For enclosures mm (in.)	Dimensions mm (in.)		References				Dimensions mm (in.)		References				Type of rails	No. of rails	References				Dimensions mm (in.)							
Height	Width	H (P)	W (S)	Thick.	References				H (P)	W (S)	Thick.	References						References			H	W	References			
60 (2.36)	700 (27.56)	-	-	-	-	-	-	-	-	-	-	-	-	-	-	-	-	-	-	-	-	-	-	120 (4.72)	734 (28.90)	AM1PA0670
120 (4.72)	700 (27.56)	-	-	-	-	-	-	-	-	-	-	-	-	-	-	-	-	-	-	-	-	-	-	180 (7.09)	734 (28.90)	AM1PA1270
300 (11.81)	150 (5.91)	-	-	-	-	-	-	-	-	-	-	-	-	-	-	-	-	-	-	-	-	-	-	349 (13.74)	228 (8.98)	AM1PA3015
300 (11.81)	195 (7.68)	-	-	-	-	-	-	-	-	-	-	-	-	-	-	-	-	-	-	-	-	-	-	349 (13.74)	258 (10.16)	AM1PA3020
300 (11.81)	200 (7.87)	265 (10.43)	150 (5.91)	4	NSYMB32	265 (10.43)	150 (5.91)	4 (0.16)	NSYMPP32	-	-	-	-	-	-	-	-	-	-	-	-	-	-	-	-	-
300 (11.81)	250 (9.84)	265 (10.43)	200 (7.87)	4	NSYMB3025	265 (10.43)	200 (7.87)	4 (0.16)	NSYMPP3025	-	-	-	-	-	-	-	-	-	-	-	-	-	-	-	-	-
300 (11.81)	300 (11.81)	265 (10.43)	250 (9.84)	4	NSYMB33	-	-	-	-	B	4	NSYMD33	-	-	-	-	-	-	-	-	-	-	-	-	-	-
300 (11.81)	500 (19.68)	-	-	-	-	-	-	-	-	-	-	-	-	-	-	-	-	-	-	-	-	-	360 (14.17)	534 (21.02)	AM1PA3050	
300 (11.81)	700 (27.56)	-	-	-	-	-	-	-	-	-	-	-	-	-	-	-	-	-	-	-	-	-	360 (14.17)	734 (28.90)	AM1PA3070	
400 (15.75)	300 (11.81)	325 (12.80)	250 (9.84)	4	NSYMB43	325 (12.80)	250 (9.84)	4 (0.16)	NSYMPP43	B	4	NSYMD43	-	-	-	-	-	-	-	-	-	-	-	-	-	-
405 (15.94)	300 (11.81)	-	-	-	-	-	-	-	-	-	-	-	-	-	-	-	-	-	-	-	-	-	465 (18.31)	334 (13.15)	AM1PA4030	
500 (19.68)	400 (15.75)	465 (18.31)	350 (13.78)	4	NSYMB54	465 (18.31)	350 (13.78)	4 (0.16)	NSYMPP54	B	4	NSYMD54	-	-	-	-	-	-	-	-	-	-	-	-	-	-
600 (23.62)	400 (15.75)	565 (22.24)	350 (13.78)	4	NSYMB64	565 (22.24)	350 (13.78)	4 (0.16)	NSYMPP64	B	6	NSYMD64	660 (25.98)	434 (17.09)	AM1PA6040											
600 (23.62)	500 (19.68)	565 (22.24)	450 (17.72)	4	NSYMB65	-	-	-	-	-	-	-	660 (25.98)	534 (21.02)	AM1PA6050											
600 (23.62)	600 (23.62)	-	-	-	-	-	-	-	-	A	6	NSYMD66	660 (25.98)	634 (24.96)	AM1PA6060											
600 (23.62)	700 (27.56)	-	-	-	-	-	-	-	-	-	-	-	660 (25.98)	734 (28.90)	AM1PA6070											
700 (27.56)	500 (19.68)	665 (26.18)	450 (17.72)	4	NSYMB75	665 (26.18)	450 (17.72)	4 (0.16)	NSYMPP75	B	6	NSYMD75	-	-	-											
705 (27.76)	500 (19.68)	-	-	-	-	-	-	-	-	-	-	-	765 (30.12)	534 (21.02)	AM1PA7050											
795 (31.30)	600 (23.62)	-	-	-	-	-	-	-	-	-	-	-	855 (33.66)	634 (24.96)	AM1PA8060											
800 (31.50)	600 (23.62)	765 (30.12)	550 (21.65)	4	NSYMB86	765 (30.12)	550 (21.65)	5 (0.20)	NSYMPP86	A	6	NSYMD86	-	-	-											
800 (31.50)	1000 (39.37)	-	-	-	NSYMB108	-	-	-	-	-	-	-	-	-	-											
800 (31.50)	1200 (47.24)	-	-	-	2 x NSYMB86	-	-	-	-	-	-	-	-	-	2 x NSYMD86											
900 (35.43)	500 (19.68)	-	-	-	-	-	-	-	-	-	-	-	960 (37.80)	534 (21.02)	AM1PA9050											
900 (35.43)	600 (23.62)	-	-	-	-	-	-	-	-	-	-	-	960 (37.80)	634 (24.96)	AM1PA9060											
900 (35.43)	700 (27.56)	-	-	-	-	-	-	-	-	-	-	-	960 (37.80)	734 (28.90)	AM1PA9070											
1000 (39.37)	600 (23.62)	965 (37.99)	550 (21.65)	4	NSYMB106	-	-	-	-	-	-	-	-	-	-											
1000 (39.37)	800 (31.50)	965 (37.99)	750 (29.53)	4	NSYMB108	965 (37.99)	750 (29.53)	5 (0.20)	NSYMPP108	A	6	NSYMD108	-	-	-											
1200 (47.24)	800 (31.50)	-	-	-	-	-	-	-	-	A	7	NSYMD128	-	-	-											
1200 (47.24)	1000 (39.37)	1150 (45.28)	950 (37.40)	4	NSYMB1210	-	-	-	-	-	-	-	-	-	-											

* Plate with reversible dimensions; It can be installed in enclosures with inverted dimensions. Example: Plate ref. **NSYMM64** can be used for the following enclosures: H 600 (23.62) x W 400 (15.75) mm (in.) or H 400 (15.75) x W 600 (23.62) mm (in.). For plain and silkscreened mounting plates: In wall-mounted enclosures with widths of 1000 (39.37) and 1200 (47.24) mm (in.), it is possible to install two mounting plates at different depths using an additional central step slide **NSYSDRSDCR...** (more information on [page 243](#)).

** To install two mounting plates in a single enclosure, also order reference **NSYCRNGSDR**. See details on [page 243](#).
To install the plate in an enclosure with six studs, also order reference **NSYEMR**.

S3D S3X PLM Elevator for microperforated mounting plate



AZ1CA04

- Mounting plate elevator to mount the microperforated mounting plate on the same level as the other Telequick system components.

Supply:
Four units

Characteristics	Reference
Elevator for microperforated mounting plate	AZ1CA04

Clip-on nuts for Telequick mounting plate



AF1EA3

- Used to easily fix devices on the Telequick mounting plate with the option of changing the layout as much as needed.

Supply:
100 units. Reference by unit. Order by multiples of 100 (100, 200, 300...)

Characteristics	Reference
Clip-on nuts for Telequick mounting plate, Model M3	AF1EA3
Clip-on nuts for Telequick mounting plate, Model M4	AF1EA4
Clip-on nuts for Telequick mounting plate, Model M5	AF1EA5
Clip-on nuts for Telequick mounting plate, Model M6	AF1EA6

S3D S3X Step slides for mounting plate



NSYSDCR200

- Set of four supports intended for installation in enclosures with depths of 200 (7.87), 250 (9.84), 300 (11.81) and 400 (15.75) mm (in.).
- The rail allows the depth of the plate and other accessories to be adjusted in steps of 12.5 (0.49) mm (in.).

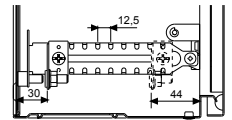

Supply:
Four step slides

Characteristics	Enclosure depth mm (in.)	Reference
Step slides for mounting plate	200 (7.87)	NSYSDCR200
Step slides for mounting plate	250 (9.84)	NSYSDCR250

S3D S3X Slide bracket for two mounting plates at different depths



NSYCRNGSDR

- Additional slide bracket to be installed on the central step slides in order to mount two mounting plates, side by side, in different depths.

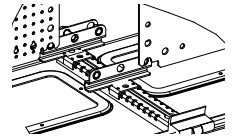

Supply:
Two slide brackets

Characteristics	Reference
Slide bracket for two mounting plates at different depths	NSYCRNGSDR

S3D S3X PLM PLA Aluminum vertical rails

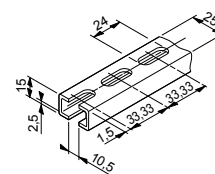

- Fixing in the enclosure with M8 nuts, ref. **NSYAMCSF** (set of 4 adapters to be ordered separately).



NSYMDVR3

Characteristics	Height mm (in.)	Supply (units)	References
Aluminum vertical rail, aluminum	300 (11.81)	10	NSYMDVR3
Aluminum vertical rail, aluminum	400 (15.75)	10	NSYMDVR4
Aluminum vertical rail, aluminum	500 (19.68)	10	NSYMDVR5
Aluminum vertical rail, aluminum	600 (23.62)	10	NSYMDVR6
Aluminum vertical rail, aluminum	700 (27.56)	10	NSYMDVR7
Aluminum vertical rail, aluminum	800 (31.50)	10	NSYMDVR8
Aluminum vertical rail, aluminum	1000 (39.37)	10	NSYMDVR10
Aluminum vertical rail, steel	1200 (47.24)	2	NSYMDVR12
Aluminum vertical rail, aluminum	3000 (118.11)	10	NSYMDVR3M

S3D S3X PLM 20 (0.79)/10° mm (in.) zinc-coated pre-drilled uprights



DZ6MZ121

- Ø 11 (0.43) mm (in.) holes enable to adjust the rows of equipment by 20 (0.79) mm (in.) steps.

Comment:
Details, see [page 305](#)

Characteristics	Height mm (in.)	Weight (g)	References
20 (0.79)/10° mm (in.) zinc-coated pre-drilled uprights	1020 (40.16)	2330 (91.73)	DZ6MZ121
20 (0.79)/10° mm (in.) zinc-coated pre-drilled uprights	1320 (51.97)	2920 (114.96)	DZ6MZ151
20 (0.79)/10° mm (in.) zinc-coated pre-drilled uprights	1620 (63.78)	3375 (132.87)	DZ6MZ181
20 (0.79)/10° mm (in.) zinc-coated pre-drilled uprights	1920 (75.59)	4000 (157.48)	DZ6MZ211

Sliding Nuts



NSYNM5

- Sliding nuts to be used on aluminum vertical rails.

Supply:
100 Sliding nuts

Characteristics	Type	References
Sliding Nut	M4	NSYNM4
Sliding Nut	M5	NSYNM5
Sliding Nut	M6	NSYNM6

Brass nuts to fix the upright to the enclosures



NSYAMCSF

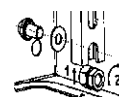

Supply:
Four Brass nuts

Characteristics	References
Brass nuts for screws M8 to fix the upright to the enclosures	NSYAMCSF

Slides and brackets



NSYSB90



NSYFB

- They allow the depth of the plates and rails to be adjusted.



Supply:
10 units. References per unit. To be ordered in multiples of 10 (10, 20, 30, etc.).

Characteristics	Width mm (in.)	Enclosure depth mm (in.)	References
Slide with bracket	90 (3.54)	150 (5.91) and 200 (7.87)	NSYSB90
Slide with bracket	130 (5.12)	250 (9.84) and 300 (11.81)	NSYSB130
Bracket for slides (customized mounting plate)			NSYFB

Notched clamp nuts

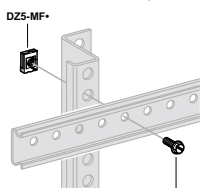

DZ5MF6

- Specially designed for pre-drilled uprights.

Supply:
100 units. References per unit. To be ordered in multiples of 100 (100, 200, 300, etc.).

Characteristics	Type	Weight (g)	References
Notched clamp nuts	M6	7.0	DZ5MF6
Notched clamp nuts	M8	8.0	DZ5MF8

SM SMX SF SFX Plain mounting plate

- Depth adjustable with a pitch of 25 (0.98) mm (in.), provided with plastic shoe for easier sliding.
- Once the plate is fixed, in advanced position, the sliding shoe can be easily removed to increase the available plate surface.
- In sets made up of two or more enclosures with mounting plates, it is possible to obtain a continuous plate surface using intermediate mounting plates (see [page 247](#)).
- Load: 300 (661.39) kg (lbs./m²)
- Maximum load: 600 (1322.77) kg (lbs.) in the back of the enclosure and 500 (1102.31) kg (lbs.) in the intermediate position
- Material: Galvanized steel

Fixing options:

- At the sides of the enclosure with the orthogonal brackets (see [page 247](#))
- Back-to-back, with the brackets for fixing the mounting plates in back-to-back position (see [page 247](#))
- For 400 (15.75) mm (in.) wide plates: with sliding rails and brackets, orthogonal brackets when mounted at back position, or with standard fixing brackets when mounted at middle position.

Supply:

One mounting plate and sliding shoes



NSYMP184

Characteristics	Width mm (in.)	Height mm (in.)	References
Plain mounting plate	400 (15.75)	1800 (70.87)	NSYMP184 New
Plain mounting plate	400 (15.75)	2000 (78.74)	NSYMP204 New
Plain mounting plate	400 (15.75)	2200 (86.61)	NSYMP224 New
Plain mounting plate	600 (23.62)	1200 (47.24)	NSYMP126
Plain mounting plate	600 (23.62)	1400 (55.12)	NSYMP146
Plain mounting plate	600 (23.62)	1600 (62.99)	NSYMP166
Plain mounting plate	600 (23.62)	1800 (70.87)	NSYMP186
Plain mounting plate	600 (23.62)	2000 (78.74)	NSYMP206
Plain mounting plate	600 (23.62)	2200 (86.61)	NSYMP226
Plain mounting plate	800 (31.50)	1200 (47.24)	NSYMP128
Plain mounting plate	800 (31.50)	1400 (55.12)	NSYMP148
Plain mounting plate	800 (31.50)	1600 (62.99)	NSYMP168
Plain mounting plate	800 (31.50)	1800 (70.87)	NSYMP188
Plain mounting plate	800 (31.50)	2000 (78.74)	NSYMP208
Plain mounting plate	800 (31.50)	2200 (86.61)	NSYMP228
Plain mounting plate	1000 (39.37)	1200 (47.24)	NSYMP1210
Plain mounting plate	1000 (39.37)	1400 (55.12)	NSYMP1410
Plain mounting plate	1000 (39.37)	1600 (62.99)	NSYMP1610
Plain mounting plate	1000 (39.37)	1800 (70.87)	NSYMP1810
Plain mounting plate	1000 (39.37)	2000 (78.74)	NSYMP2010
Plain mounting plate	1000 (39.37)	2200 (86.61)	NSYMP2210
Plain mounting plate	1200 (47.24)	1200 (47.24)	NSYMP1212
Plain mounting plate	1200 (47.24)	1400 (55.12)	NSYMP1412
Plain mounting plate	1200 (47.24)	1600 (62.99)	NSYMP1612
Plain mounting plate	1200 (47.24)	1800 (70.87)	NSYMP1812
Plain mounting plate	1200 (47.24)	2000 (78.74)	NSYMP2012
Plain mounting plate	1200 (47.24)	2200 (86.61)	NSYMP2212
Plain mounting plate	1600 (62.99)	1800 (70.87)	NSYMP1816
Plain mounting plate	1600 (62.99)	2000 (78.74)	NSYMP2016

SM SMX SF SFX SD SDX Perforated mounting plate Telequick



- Allows the installation of switchgear without drilling or screwing.
- Plate designed for quick-fixing of switchgear by means of clip-on nuts ref. **AF1EA3** to **AF1EA6**.
- Vertical continuity is reinforced by the vertical installation of plates.
- The top plate must be fixed in the third hole, 80 (3.15) mm (in.) from the top frame.
- Load: 150 (330.69) kg (lbs.)/m²
- Material: Zinc-coated steel

Fixing options:

- Directly to the vertical uprights of the structure, by means of self-tapping screws (only Spacial SF)
- To the technical vertical uprights, by means of sliding nuts, see [page 251](#);
- To standard uprights by means of flat nuts, see [page 251](#) or self-tapping screws, and to cross-rails

Comment:

Examples of combination see [page 306](#)

Supply:

One perforated mounting plate and fixing elements for technical uprights and screws for fixing to the structure or cross-rails

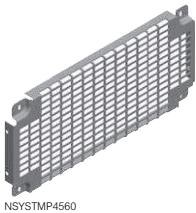

NSYSTMP4560

Characteristics	Width mm (in.)	Plate height mm (in.)				Useful surface (dm ²)	References
		D	E	F	G		
Perforated mounting plate Telequick	600 (23.62)	450 (17.72)	200 (7.87)	-	100 (3.94)	11.4	NSYSTMP2260
Perforated mounting plate Telequick	600 (23.62)	450 (17.72)	425 (16.73)	-	325 (12.80)	22.8	NSYSTMP4560
Perforated mounting plate Telequick	600 (23.62)	450 (17.72)	575 (22.64)	125 (4.92)	475 (18.70)	30.4	NSYSTMP6060
Perforated mounting plate Telequick	600 (23.62)	450 (17.72)	800 (31.50)	250 (9.84)	700 (27.56)	11.9	NSYSTMP8260
Perforated mounting plate Telequick	800 (31.50)	650 (25.59)	200 (7.87)	-	100 (3.94)	15.9	NSYSTMP2280
Perforated mounting plate Telequick	800 (31.50)	650 (25.59)	425 (16.73)	-	325 (12.80)	31.8	NSYSTMP4580
Perforated mounting plate Telequick	800 (31.50)	650 (25.59)	575 (22.64)	125 (4.92)	475 (18.70)	42.4	NSYSTMP6080
Perforated mounting plate Telequick	800 (31.50)	650 (25.59)	800 (31.50)	250 (9.84)	700 (27.56)	58.4	NSYSTMP8280
Perforated mounting plate Telequick	1000 (39.37)	850 (33.46)	200 (7.87)	-	100 (3.94)	20.4	NSYSTMP22100
Perforated mounting plate Telequick	1000 (39.37)	850 (33.46)	425 (16.73)	-	325 (12.80)	40.8	NSYSTMP45100
Perforated mounting plate Telequick	1000 (39.37)	850 (33.46)	575 (22.64)	125 (4.92)	475 (18.70)	54.4	NSYSTMP60100
Perforated mounting plate Telequick	1000 (39.37)	850 (33.46)	800 (31.50)	250 (9.84)	700 (27.56)	74.9	NSYSTMP82100
Perforated mounting plate Telequick	1200 (47.24)	1050 (41.34)	200 (7.87)	-	100 (3.94)	24.9	NSYSTMP22120
Perforated mounting plate Telequick	1200 (47.24)	1050 (41.34)	425 (16.73)	-	325 (12.80)	49.9	NSYSTMP45120
Perforated mounting plate Telequick	1200 (47.24)	1050 (41.34)	575 (22.64)	125 (4.92)	475 (18.70)	66.5	NSYSTMP60120
Perforated mounting plate Telequick	1200 (47.24)	1050 (41.34)	800 (31.50)	250 (9.84)	700 (27.56)	91.5	NSYSTMP82120

SM SF SFX Partial mounting plate

- Partial mounting plate, provided with reinforcement flange on its four sides.
- Load: 250 (551.16) kg (lbs.)/m²
- Material: Galvanized steel

Fixing options:

Spacial SF, SFX:

- Fixing to the vertical uprights of the structure
- Fixing to the technical or standard vertical uprights, see [page 251](#)
- For installations in advanced position, fixing to cross-rails, see [page 254](#)

Spacial SM:

- Fixing by means of adaptation profiles and 40 (1.58) mm (in.) universal cross-rails (one row) in vertical position, or also on horizontal universal cross-rails
- It can be mounted horizontally, as a tray, by means of depthwise cross-rails, see [page 254](#)

Supply:

Partial mounting plate and fixing elements

10



NSYSPMP2560

Characteristics	Width mm (in.)	Plate height mm (in.)	Plate length mm (in.)	References
	B	H	B-100	
Partial mounting plate	600 (23.62)	247 (9.72)	500 (19.68)	NSYSPMP2560
Partial mounting plate	600 (23.62)	247 (9.72)	750 (29.53)	NSYSPMP2575
Partial mounting plate	600 (23.62)	397 (15.63)	500 (19.68)	NSYSPMP4060
Partial mounting plate	600 (23.62)	597 (23.50)	500 (19.68)	NSYSPMP6060
Partial mounting plate	800 (31.50)	247 (9.72)	700 (27.56)	NSYSPMP2580
Partial mounting plate	800 (31.50)	397 (15.63)	700 (27.56)	NSYSPMP4080
Partial mounting plate	800 (31.50)	597 (23.50)	700 (27.56)	NSYSPMP6080
Partial mounting plate	1000 (39.37)	247 (9.72)	900 (35.43)	NSYSPMP25100
Partial mounting plate	1000 (39.37)	397 (15.63)	900 (35.43)	NSYSPMP40100
Partial mounting plate	1000 (39.37)	597 (23.50)	900 (35.43)	NSYSPMP60100
Partial mounting plate	1200 (47.24)	247 (9.72)	1100 (43.31)	NSYSPMP25120
Partial mounting plate	1200 (47.24)	397 (15.63)	1100 (43.31)	NSYSPMP40120
Partial mounting plate	1200 (47.24)	597 (23.50)	1100 (43.31)	NSYSPMP60120
Partial mounting plate	1600 (62.99)	397 (15.63)	1100 (43.31)	NSYSPMP40160

SF SFX Intermediate mounting plate

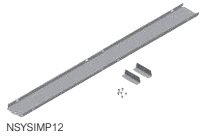

- Obtains a continuous surface of the mounting plate at enclosure suites.
- Adjustable depth with a pitch of 25 (0.98) mm (in.). When the mounting plates are located in the back of the enclosure, the vertical profiles of the structure are flush with the plates, acting as an intermediate mounting plate. In this case the intermediate plate cannot be installed.
- Material: Galvanized steel



Supply:
One intermediate plate and fixing elements

Characteristics	Height mm (in.)	References
Intermediate mounting plate	1200 (47.24)	NSYSIMP12
Intermediate mounting plate	1400 (55.12)	NSYSIMP14
Intermediate mounting plate	1600 (62.99)	NSYSIMP16
Intermediate mounting plate	1800 (70.87)	NSYSIMP18
Intermediate mounting plate	2000 (78.74)	NSYSIMP20
Intermediate mounting plate	2200 (86.61)	NSYSIMP22

SF SFX Intermediate fixing of the mounting plate, located in the back of the enclosure

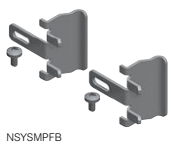

- Support for additional fixing of the mounting plate, at any height of the plate when the plate is mounted in the back of the enclosure.
- The supports minimize the vibration of the plate during the transport and operation of the panel.
- Material: Zinc-coated steel
- **Fixing:** The supports are fixed to the structure when the plate is already located in the back of the enclosure
Spacial SM: Fixing to 40 (1.58) mm (in.) universal cross-rails (one row), installed vertically in the back of the enclosure, see [page 254](#)



Supply:
Ten units and fixing elements.
Reference by unit. Order by multiples of 10 (10, 20, 30...)

Characteristics	References
Intermediate fixing of the mounting plate, located in the back of the enclosure	NSYSMPFB

SF SFX Intermediate fixing of the mounting plate, in advanced position

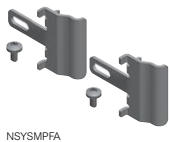

- Support for additional fixing of the mounting plate, at any height of the plate when the plate is mounted in advanced position.
- The supports minimize the vibration of the plate during the transport and operation of the panel.
- Material: Zinc-coated steel
- **Fixing:** The supports are mounted on light cross-rails or on 40 (1.58) mm (in.) (one row) universal or quick-fixing cross-rails (not supplied), see [page 254](#)



Supply:
Ten units and fixing elements.
Reference by unit. Order by multiples of 10 (10, 20, 30...)

Characteristics	References
Intermediate fixing of the mounting plate, in advanced position	NSYSMPFA

SF SFX Reinforcement for mounting plate



- Reinforcement kit for transversal mounting plate.
- Provides extra rigidity to the mounting plates and absorbs vibrations.
- Can be used as a support for fixing very heavy elements.
- Material: Zinc-coated steel
- Thickness: 15 (0.59)/10° mm (in.)

Supply:
Two profiles, four supports for fixing to the mounting plate and fixing elements

Characteristics	Width mm (in.)	References
Reinforcement for mounting plate	800 (31.50)	NSYMPRK8
Reinforcement for mounting plate	1000 (39.37)	NSYMPRK10
Reinforcement for mounting plate	1200 (47.24)	NSYMPRK12
Reinforcement for mounting plate	1600 (62.99)	NSYMPRK16

Mounting plate accessories

Self-tapping screw



- Hexagonal head, 4.8 (0.19) x 16 (0.63) mm (in.) thread.
- Drilling capacity: Thicknesses between 17 (0.67).5/10° (in.) and 40 (1.58)/10° mm (in.).

Supply:
100 units. To be ordered in multiples of 100 (100, 200, 300, etc.).

Characteristics	References
Self-tapping screw	NSYS16M5HS

Mounting Plate Brackets for Floor-Standing Enclosures

SM SMX SF SFX Mounting plate fixing brackets



NSYSFPB

- For direct mounting on the structure of the enclosure.
- Adjustable depth with a pitch of 25 (0.98) mm (in.).
- Material: Zinc-coated steel
- Maximum load: Four brackets: 600 (1322.77) kg (lbs.)

Supply:
Four brackets and fixing elements

Characteristics	References
Spacial SF Mounting plate fixing brackets	NSYSFPB
Spacial SM/SMX/SFX Mounting plate fixing brackets	NSYSMPB

SF SFX Orthogonal brackets



NSYSMPB

- Designed for the installation of mounting plates on the sides of the enclosure.
- When installing one plate in the back of the enclosure and one plate at the side, they must both be installed using orthogonal brackets.
- Spacial SFX: Mounting the lateral mounting plate requires the removal of the one on the back and its fixing brackets. Material: Zinc-coated steel
- Maximum load: Four brackets: 600 (1322.77) kg (lbs.)

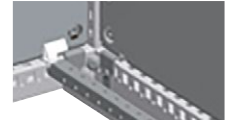

Supply:
Four brackets and fixing elements

Characteristics	References
Spacial SF/SFX Orthogonal brackets	NSYSMPB

SF Mounting plate sliding rails



NSYSMPS4

- Rail in which the mounting plate slides along when inserted in the enclosure.
- Once the mounting plate is installed and fixed to the brackets, the sliding rails can be removed to maximize the cable passage surface, and can be installed depthwise in other positions.
- Material: Zinc-coated steel



Supply:
Four brackets and fixing elements

Characteristics	Depth mm (in.)	References
Spacial SF Mounting plate sliding rails	400 (15.75)	NSYSMPS4
Spacial SF Mounting plate sliding rails	500 (19.68)	NSYSMPS5
Spacial SF Mounting plate sliding rails	600 (23.62)	NSYSMPS6
Spacial SF Mounting plate sliding rails	800 (31.50)	NSYSMPS8

Brackets for fixing mounting plates in back-to-back position



NSYSBTB

- Doubling the mounting surface.
- Adjustable with a pitch of 25 (0.98) mm (in.).
- Material: Zinc-coated steel

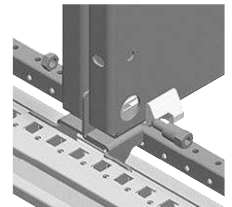
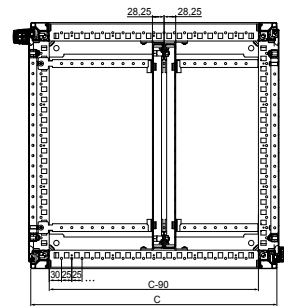

Supply:
Four brackets for fixing back-to-back and fixing elements

Characteristics	References
Brackets for fixing mounting plates in back-to-back position	NSYSBTB

SM SMX SF SFX Brackets for fixing intermediate mounting plates in back-to-back position



NSYSIBTB

- Doubling the mounting surface.
- Adjustable with a pitch of 25 (0.98) mm (in.).
- Material: Zinc-coated steel

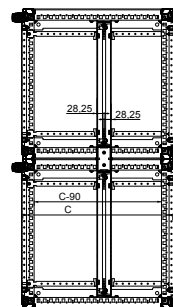

Supply:
2 brackets for fixing intermediate plates back-to-back and fixing elements

Characteristics	References
Spacial SM/SMX/SF/SDX Brackets for fixing intermediate mounting plates in back-to-back position	NSYSIBTB

Technical changes reserved. Information provided without guarantee. Images are for illustrative purposes only.

SF **SFX** Side entry rails for the mounting plate

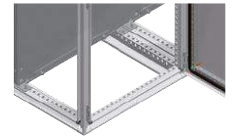

- Side entry device for the mounting plates when coupling Spacial SF enclosures or Spacial SFX.
- The mounting plates can be coupled with one another, and are fixed to the side entry guide by pressure.
- Material: Zinc-coated steel

Supply:
Two rails (top and bottom)
and fixing elements

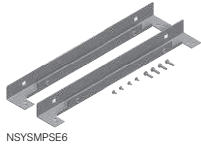

Characteristics	Width mm (in.)	References
Spacial SF/SFX Side entry rails for the mounting plate	600 (23.62)	NSYSMPSE6
Spacial SF/SFX Side entry rails for the mounting plate	800 (31.50)	NSYSMPSE8
Spacial SF/SFX Side entry rails for the mounting plate	1000 (39.37)	NSYSMPSE10
Spacial SF/SFX Side entry rails for the mounting plate	1200 (47.24)	NSYSMPSE12

SM Top/bottom adjustment rails

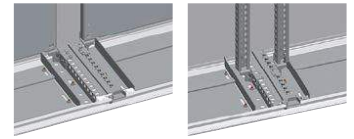

Comment:
Examples of combination see [page 307](#)

Supply:
Two rails, top and bottom

- Allows the installation of two mounting plates or vertical uprights in enclosures with a width of 1200 (47.24) mm (in.) and 1600 (62.99) mm (in.), as if in two independent enclosures.
- A set of mounting plate fixing brackets ref. **NSYSMPB** is required.
- Optional installation of an intermediate mounting plate.
- Material: Galvanized steel



NSYSTBR3

Characteristics	Depth mm (in.)	References
Spacial SM Top/bottom adjustment rails	300 (11.81)	NSYSTBR3
Spacial SM Top/bottom adjustment rails	400 (15.75)	NSYSTBR4
Spacial SM Top/bottom adjustment rails	500 (19.68)	NSYSTBR5
Spacial SM Top/bottom adjustment rails	600 (23.62)	NSYSTBR6

SF Kit for adapting two-door enclosures

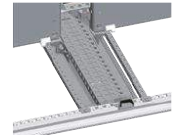

Comment:
Examples of combination see [page 307](#)

- Allows the installation of two mounting plates as if in two independent enclosures.
- A set of brackets for fixing mounting plates ref. **NSYSMPB** is required.
- Option of installing an intermediate mounting plate.
- Valid for enclosures with widths of 1200 (47.24) and 1600 (62.99) mm (in.).
- If installing a cable gland plate for a width of 1200 (47.24) mm (in.), it is necessary to install two with a width of 600 (23.62) mm (in.), and for widths of 1600 (62.99) mm (in.), two with a width of 800 (31.50) mm (in.).



NSYSMP2D4

Characteristics	Depth mm (in.)	References
Spacial SF Kit for adapting two-door enclosures	400 (15.75)	NSYSMP2D4
Spacial SF Kit for adapting two-door enclosures	500 (19.68)	NSYSMP2D5
Spacial SF Kit for adapting two-door enclosures	600 (23.62)	NSYSMP2D6
Spacial SF Kit for adapting two-door enclosures	800 (31.50)	NSYSMP2D8



SM SMX SF SFX Technical uprights
SD SDX PLA PHD

- Vertical uprights for fixing plates and rails.
- They can be fixed to the fixing brackets of the mounting plate or to the uprightfixing bracket (ref. **NSYMF8**).
- Adjustable height in steps of 2.5 (0.10) mm (in.) (with quarter-turn nuts, ref. **NSYSNM6** or **NSYSNM8**) or 25 (0.98) mm (in.) (with cage nuts, ref. **NSYCNM6** or **NSYCNM8**).
- Material: Galvanized steel
- Thickness: 20 (0.79)/10^e mm (in.)

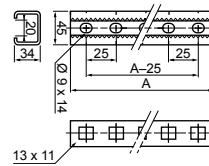

Comment:
NSYTVR20 is not compatible with PLA or PHD 2000 mm high enclosures. Use 2 x **NSYTVR10**.

Supply:
Set of two uprights



Characteristics	Height mm (in.)	A mm (in.)	References
SM/SMX/SF/SFX/SD/SDX/PLA/PHD Technical uprights	750 (29.53)	625 (24.61)	NSYTVR7
SM/SMX/SF/SFX/SD/SDX/PLA/PHD Technical uprights * Control desk.	1000 (39.37)*	675 (26.58)	NSYTVR8
SM/SMX/SF/SFX/SD/SDX/PLA/PHD Technical uprights	1000 (39.37)	875 (34.45)	NSYTVR10
SM/SMX/SF/SFX/SD/SDX/PLA/PHD Technical uprights	1200 (47.24)	1075 (42.32)	NSYTVR12
SM/SMX/SF/SFX/SD/SDX/PLA/PHD Technical uprights	1250 (49.21)	1125 (44.29)	NSYTVR12S
SM/SMX/SF/SFX/SD/SDX/PLA/PHD Technical uprights	1400 (55.12)	1275 (50.20)	NSYTVR14
SM/SMX/SF/SFX/SD/SDX/PLA/PHD Technical uprights	1500 (59.06)	1375 (54.13)	NSYTVR15
SM/SMX/SF/SFX/SD/SDX/PLA/PHD Technical uprights	1600 (62.99)	1475 (58.07)	NSYTVR16
SM/SMX/SF/SFX/SD/SDX/PLA/PHD Technical uprights	1800 (70.87)	1675 (65.94)	NSYTVR18
SM/SMX/SF/SFX/SD/SDX Technical uprights	2000 (78.74)	1875 (73.82)	NSYTVR20
SM/SMX/SF/SFX/SD/SDX/PLA/PHD Technical uprights	2200 (86.61)	2075 (81.69)	NSYTVR22

SM SMX SF SFX Standard uprights

- Vertical uprights for fixing plates and rails.
- They can be fixed on the mounting plate fixing brackets or on the upright fixing bracket, ref. **NSYMF8**.
- Adjustable height with a pitch of 25 (0.98) or 50 (1.97) mm (in.).
- Material: Galvanized steel
- Thickness: 20 (0.79)/10^e mm (in.)

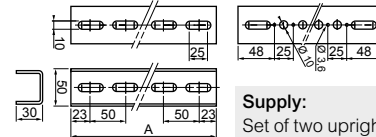

Supply:
Set of two uprights



Characteristics	Height mm (in.)	A mm (in.)	References
SM/SMX/SF/SFX Standard uprights	1800 (70.87)	1696 (66.77)	NSYVR18
SM/SMX/SF/SFX Standard uprights	2000 (78.74)	1896 (74.65)	NSYVR20
SM/SMX/SF/SFX Standard uprights	2200 (86.61)	2096 (82.52)	NSYVR22

Nuts and screws for technical uprights

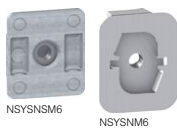

Characteristics	Supply (units)	References
M6 quarter-turn sliding nut	10	NSYSNM6
M8 quarter-turn sliding nut	10	NSYSNM8
M6 quarter-turn serrated sliding nut	10	NSYSNSM6
M8 quarter-turn serrated sliding nut	10	NSYSNSM8
M6 renovable nut	50	NSYCNM6
M8 renovable nut	50	NSYCNM8
M6 x 12 (0.47) mm (in.) screw	100	AF1VA612
M6 x 18 (0.71) mm (in.) screw	100	AF1VA618
M8 x 20 (0.79) mm (in.) screw	100	AF1VC820

Nuts and screws for standard uprights



Characteristics	Supply (units)	References
M6 flat nut	50	NSYFNM6
M8 flat nut	50	NSYFNM8
M6 x 12 (0.47) mm (in.) screw	100	AF1VA612
M6 x 18 (0.71) mm (in.) screw	100	AF1VA618
M8 x 20 (0.79) mm (in.) screw	100	AF1VC820

Bracket for fixing uprights

- Brackets for fixing the uprights, standard or technical, at the same level as the structure, obtaining a greater working surface inside the enclosure.
- They allow two pairs of uprights to be fixed back to back, doubling the working surface.
- The brackets are fixed to the structure by means of M6 self-tapping screws.
- Adjustable depth with a pitch of 25 (0.98) mm (in.).
- Material: Zinc-coated steel.

Supply:
Four brackets for fixing uprights and fixing elements.



Characteristics	References
Bracket for fixing uprights	NSYMF8

Technical changes reserved. Information provided without guarantee. Images are for illustrative purposes only.

SM SMX SF SFX SD SDX

Rail support bracket



NSYFB45

- Bracket for fixing rails at an angle of 45°.
- Material: Zinc-coated steel
- Installation: Spacial SF: Mounted on the structure and/or mounting plates
Spacial SM: Mounted on the bottom mounting rail and/or mounting plates



Supply:
Ten units and fixing elements.
Reference by unit. Order by multiples of 10 (10, 20, 30...)



Characteristics	References
Rail support bracket	NSYFB45

Combined support bracket



NSYETF

- Allows the installation of a DIN rail and an earthing strip on different planes to minimize the cable radiuses.
- Material: Zinc-coated steel
- Installation: Spacial SF: Directly on the structure and/or using mounting plates
Spacial SM: On the bottom adjustment rails and/or on mounting plates

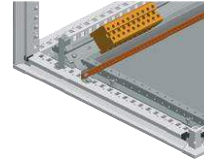

Supply:
Ten combined support brackets and fixing elements.
Reference by unit. Order by multiples of 10 (10, 20, 30...)

Characteristics	References
Combined support bracket	NSYETF

Terminal-block support bracket



NSYEDCO

- Allows the mounting of a DIN rail.
- Tilted to 45°.
- Material: Treated steel

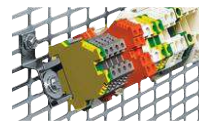

Supply:
Two lugs and fixings



Characteristics	References
Terminal-block support bracket	NSYEDCO

Combined fixing lugs for the earthing strip



NSYEDCOC

- Allow the mounting of an earth collector rail and a DIN rail.
- Tilted to 30°.
- Earthing strip, ref. **NSYECB1M153**. See [page 303](#).

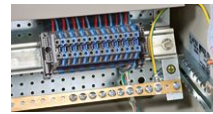

Supply:
Two fixing lugs and fixing elements



Characteristics	References
Combined fixing lugs for the earthing strip	NSYEDCOC

Combined support bracket (vertical)



DZ5MS10

- Allows the installation of a DIN rail and an earthing strip on different planes, to minimize the cable radiuses.
- Material: Zinc-coated steel
- Installation: Spacial SF/SM: Directly on the vertical structure and/or using mounting plates



Supply:
10 brackets

Characteristics	References
Combined support bracket (vertical)	DZ5MS10

10

Clicked support plate



AX2DL01

- For screw mounted equipment.
- For mounting on 35 (1.38) mm (in.) symmetric and double profile DIN rails or Telequick mounting plate.
- Material: Zinc-plate coated

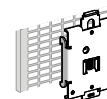

Supply:
Ten units and fixing elements.
Reference by unit. Order by multiples of 10 (10, 20, 30...)



Characteristics	References
Clicked support plate, 44 (1.73) x 65 (2.56) mm (in.) - 9 screws	AX2DL01
Clicked support plate, 49 (1.93) x 65 (2.56) mm (in.) - 4 screws	AX2DL02

Bracket for fixing control units (Ø 22)



DX1AP52

- To mount any 22 (0.87) mm (in.) diameter device directly on mounting plates.

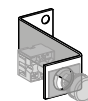

Supply:
Ten units and fixing elements.
Reference by unit. Order by multiples of 10 (10, 20, 30...)



Characteristics	References
Bracket for fixing control units (Ø 22 (0.87) mm (in.))	DX1AP52

Cross-Rails and Profiles for Floorstanding Enclosures

- SM
- SMX
- SF
- SFX
- SD
- SDX



In the Spacial SF, SM, SFX and SMX enclosures, it is possible to create a fixing at any point of the inner volume, providing mounting planes with different widths, heights and depths. In the case of the Spacial SM, it may be necessary to install vertical/horizontal adaptation profiles and 40 (1.58) mm (in.) universal cross-rails (one row).



- Four types of cross-rails are available to create fixing points:**
- Universal cross-rails (see [page 254](#))
 - Quick-fixing cross-rails (see [page 255](#))
 - Integrated cross-rails (see [page 256](#))
 - Light cross-rails (see [page 256](#))

- Universal, quick-fixing and integrated cross-rails are available in 3 sizes:**
- 40 (1.58) mm (in.) (1 row)
 - 65 (2.56) mm (in.) (2 rows)
 - 90 (3.54) mm (in.) (3 rows)

- Cross-rails for specific applications are also available:**
- Cross-rails for heavy loads (see [page 257](#)) to be fixed on the bottom part of the enclosure or to be combined with a "heavy load kit" (see [page 260](#)) to be used at any height in the enclosure
 - Cross-rails for Lütze chassis (see [page 257](#))

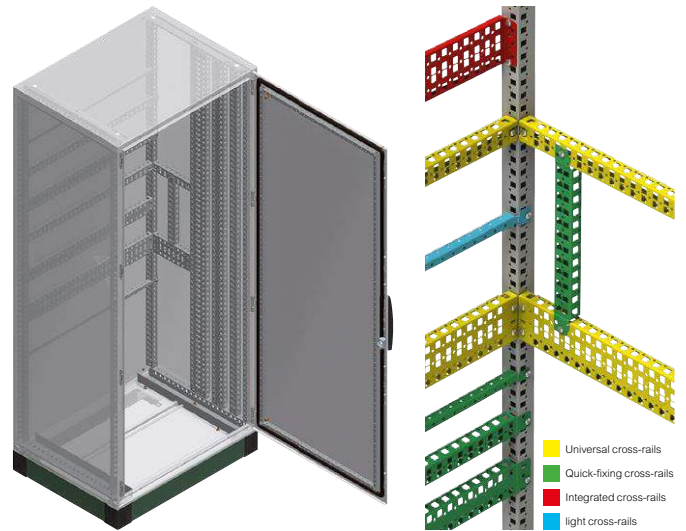
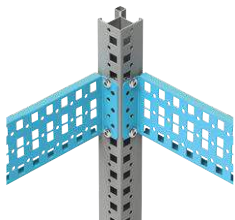

Combination examples



Spacial SF and SFX:
The cross-rails can be fixed to the structure and among each other, offering multiple options.

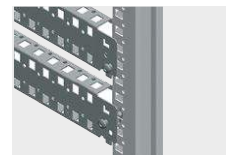

The quick-fixing cross-rails can be fixed directly to the structure, quickly and easily. Spacial SF and SFX*:

- They clip onto the structure and are fixed by M6 self-tapping screws, or optionally with M6 caged nuts.

Spacial SM:

- Possibility of clipping onto the adaptation profile or another cross-rail.
- Fixing by means of M6 self-tapping screws.
- Fixing by means of M6 caged nuts.

* In Spacial SFX enclosures, it cannot be mounted depthwise.

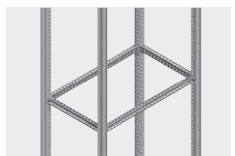

Universal cross-rails and integrated cross-rails can be simultaneously mounted at the same height, on all the sides of the enclosure. To perform this type of installation in a Spacial SM enclosure, the vertical adaptation profile and the vertical 40 (1.58) mm (in.) universal cross-rail (one row) are required, mounted in the back of the enclosure.

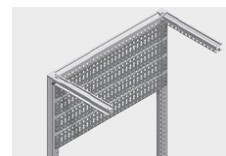

Quick-fixing cross-rails can be used to support equipments at the back of the enclosure or be fixed every 25 (0.98) mm (in.) on two cross-rails (universal or integrated) in vertical position.

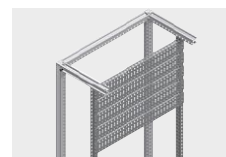

40 (1.58) mm (in.) wide universal and integrated cross-rails can be used as uprights, adjustable every 25 (0.98) mm (in.) in depth. They enable the fixing of diverse equipment supports and are adjustable every 25 (0.98) mm (in.) in height.



Spacial SF:
Universal cross-rails and integrated cross-rails can be mounted in vertical position.

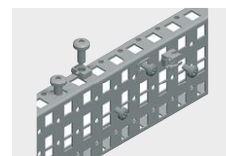

The main fixing point to the quick-fixing cross-rails is the 5.2 (0.20) mm (in.) drill hole for M6 self-tapping screw, although they can also receive M6 and M8 caged nuts.

SM SMX SF SFX Universal cross-rails
SD SDX



- Used for the creation of structures inside the enclosure.
- Cross-rails available in three sizes:
40 (1.58) mm (in.) (one row), 65 (2.56) mm (in.) (two rows) and 90 (3.54) mm (in.) (three rows).
- Each row is perforated every 25 (0.98) mm (in.) with a 5.2 (0.20) mm (in.) diameter hole and a 11 (0.43) x 13 (0.51) mm (in.) cutout which enables fixing by means of M6 self-tapping screws, ref **NSYST30M6S**.
- Equipment is fixed by means of caged nuts or self-tapping screws.
- Material: Zinc-coated steel
- Thickness: 15 (0.59)/10^a mm (in.)

Fixing to the structure:

Fixing accordingly to uprights axis.
Possibility to mount cross-rails simultaneously on all sides,
at the same height of the enclosure.

Comment:

- (1) For vertical assembly only.
- (2) Cross-rails only for fixing cables.
- (3) These cross-rails have not been sized to be used in the width, depth or height of the enclosure, but to be mounted in other positions or in between cross-rails.

For dimensions see [page 308](#)

Supply:

Two cross-rails, four supports for cross-rails and fixing elements

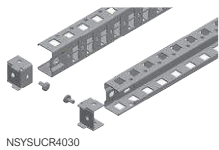

Characteristics	Width of the cross-rails mm (in.)	H / L / P (Dn) of enclosure mm (in.)	Maximum load by rail kg (lbs.)	References
Universal cross-rails	40 (1.58) (1 row)	300 (11.81)	70 (154.32)	NSYSUCR4030
Universal cross-rails	40 (1.58) (1 row)	400 (15.75)	60 (132.28)	NSYSUCR4040
Universal cross-rails	40 (1.58) (1 row)	500 (19.68)	60 (132.28)	NSYSUCR4050
Universal cross-rails	40 (1.58) (1 row)	600 (23.62)	50 (110.23)	NSYSUCR4060
Universal cross-rails	40 (1.58) (1 row)	700 (27.56) (3)	50 (110.23)	NSYSUCR4070
Universal cross-rails	40 (1.58) (1 row)	800 (31.50)	40 (88.18)	NSYSUCR4080
Universal cross-rails	40 (1.58) (1 row)	900 (35.43) (3)	40 (88.18)	NSYSUCR4090
Universal cross-rails	40 (1.58) (1 row)	1000 (39.37)	30 (66.14)	NSYSUCR40100
Universal cross-rails	40 (1.58) (1 row)	1100 (43.31) (3)	30 (66.14)	NSYSUCR40110
Universal cross-rails	40 (1.58) (1 row)	1200 (47.24)	20 (44.09)	NSYSUCR40120
Universal cross-rails	40 (1.58) (1 row)	1400 (55.12)	(1)	NSYSUCR40140
Universal cross-rails	40 (1.58) (1 row)	1600 (62.99)	(1)	NSYSUCR40160
Universal cross-rails	40 (1.58) (1 row)	1800 (70.87)	(1)	NSYSUCR40180
Universal cross-rails	40 (1.58) (1 row)	2000 (78.74)	(1)	NSYSUCR40200
Universal cross-rails	40 (1.58) (1 row)	2200 (86.61)	(1)	NSYSUCR40220
Universal cross-rails	65 (2.56) (2 rows)	300 (11.81)	110 (242.51)	NSYSUCR6530
Universal cross-rails	65 (2.56) (2 rows)	400 (15.75)	100 (220.46)	NSYSUCR6540
Universal cross-rails	65 (2.56) (2 rows)	500 (19.68)	90 (198.42)	NSYSUCR6550
Universal cross-rails	65 (2.56) (2 rows)	600 (23.62)	80 (176.37)	NSYSUCR6560
Universal cross-rails	65 (2.56) (2 rows)	800 (31.50)	70 (154.32)	NSYSUCR6580
Universal cross-rails	65 (2.56) (2 rows)	1000 (39.37)	50 (110.23)	NSYSUCR65100
Universal cross-rails	65 (2.56) (2 rows)	1200 (47.24)	50 (110.23)	NSYSUCR65120
Universal cross-rails	65 (2.56) (2 rows)	1400 (55.12)	(1)	NSYSUCR65140
Universal cross-rails	65 (2.56) (2 rows)	1600 (62.99)	(1)	NSYSUCR65160
Universal cross-rails	65 (2.56) (2 rows)	1800 (70.87)	(1)	NSYSUCR65180
Universal cross-rails	65 (2.56) (2 rows)	2000 (78.74)	(1)	NSYSUCR65200
Universal cross-rails	65 (2.56) (2 rows)	2200 (86.61)	(1)	NSYSUCR65220
Universal cross-rails	90 (3.54) (3 rows)	300 (11.81)	130 (286.60)	NSYSUCR9030
Universal cross-rails	90 (3.54) (3 rows)	400 (15.75)	120 (264.55)	NSYSUCR9040
Universal cross-rails	90 (3.54) (3 rows)	500 (19.68)	120 (264.55)	NSYSUCR9050
Universal cross-rails	90 (3.54) (3 rows)	600 (23.62)	110 (242.51)	NSYSUCR9060
Universal cross-rails	90 (3.54) (3 rows)	700 (27.56) (3)	110 (242.51)	NSYSUCR9070
Universal cross-rails	90 (3.54) (3 rows)	800 (31.50)	100 (220.46)	NSYSUCR9080
Universal cross-rails	90 (3.54) (3 rows)	900 (35.43) (3)	100 (220.46)	NSYSUCR9090
Universal cross-rails	90 (3.54) (3 rows)	1000 (39.37)	70 (154.32)	NSYSUCR90100
Universal cross-rails	90 (3.54) (3 rows)	1100 (43.31) (3)	70 (154.32)	NSYSUCR90110
Universal cross-rails	90 (3.54) (3 rows)	1200 (47.24)	70 (154.32)	NSYSUCR90120
Universal cross-rails	90 (3.54) (3 rows)	1400 (55.12)	(1)	NSYSUCR90140
Universal cross-rails	90 (3.54) (3 rows)	1600 (62.99)	(1)	NSYSUCR90160
Universal cross-rails	90 (3.54) (3 rows)	1800 (70.87)	(1)	NSYSUCR90180
Universal cross-rails	90 (3.54) (3 rows)	2000 (78.74)	(1)	NSYSUCR90200
Universal cross-rails	90 (3.54) (3 rows)	2200 (86.61)	(1)	NSYSUCR90220

SM SMX SF SFX Quick-fixing cross-rails
SD SDX



- Used for the creation of structures inside the enclosure.
- Cross-rails available in three sizes:
40 (1.58) mm (in.) (one row), 65 (2.56) mm (in.) (two rows) and 90 (3.54) mm (in.) (three rows).
- Each row is perforated every 25 (0.98) mm (in.) with a 5.2 (0.20) mm (in.) diameter hole and a 11 (0.43) x 13 (0.51) mm (in.) cutout which enables fixing by means of M6 self-tapping screws, ref **NSYST30M6S**.
- Equipment are fixed by means of caged nuts or self-tapping screws.
- Material: Zinc-coated steel
- Thickness: 15 (0.59)/10^a mm (in.)

Comment:

- (1) For vertical assembly only.
- (2) Cross-rails only for fixing cables.
- (3) These cross-rails have not been sized to be used in the width, depth or height of the enclosure, but to be mounted in other positions or in between cross-rails.

For dimensions see [page 308](#)

Fixing to the structure:

Fixing accordingly to uprights axis.

It is not possible to mount two cross-rails on one level with an upright

Supply:

Two cross-rails and fixing elements

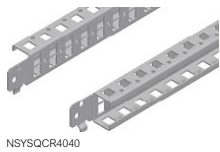

Characteristics	Width of the cross-rails mm (in.)	H / L / P (Dn) of enclosure mm (in.)	Maximum load by rail kg (lbs.)	References
Quick-fixing cross-rails	40 (1.58) (1 row)	400 (15.75)	60 (132.28)	NSYSQCR4040
Quick-fixing cross-rails	40 (1.58) (1 row)	500 (19.68)	60 (132.28)	NSYSQCR4050
Quick-fixing cross-rails	40 (1.58) (1 row)	600 (23.62)	50 (110.23)	NSYSQCR4060
Quick-fixing cross-rails	40 (1.58) (1 row)	800 (31.50)	40 (88.18)	NSYSQCR4080
Quick-fixing cross-rails	40 (1.58) (1 row)	1000 (39.37)	30 (66.14)	NSYSQCR40100
Quick-fixing cross-rails	40 (1.58) (1 row)	1200 (47.24)	20 (44.09)	NSYSQCR40120
Quick-fixing cross-rails	65 (2.56) (2 rows)	400 (15.75)	100 (220.46)	NSYSQCR6540
Quick-fixing cross-rails	65 (2.56) (2 rows)	500 (19.68)	90 (198.42)	NSYSQCR6550
Quick-fixing cross-rails	65 (2.56) (2 rows)	600 (23.62)	80 (176.37)	NSYSQCR6560
Quick-fixing cross-rails	65 (2.56) (2 rows)	800 (31.50)	70 (154.32)	NSYSQCR6580
Quick-fixing cross-rails	65 (2.56) (2 rows)	1000 (39.37)	50 (110.23)	NSYSQCR65100
Quick-fixing cross-rails	65 (2.56) (2 rows)	1200 (47.24)	50 (110.23)	NSYSQCR65120
Quick-fixing cross-rails	90 (3.54) (3 rows)	400 (15.75)	120 (264.55)	NSYSQCR9040
Quick-fixing cross-rails	90 (3.54) (3 rows)	500 (19.68)	120 (264.55)	NSYSQCR9050
Quick-fixing cross-rails	90 (3.54) (3 rows)	600 (23.62)	110 (242.51)	NSYSQCR9060
Quick-fixing cross-rails	90 (3.54) (3 rows)	800 (31.50)	100 (220.46)	NSYSQCR9080
Quick-fixing cross-rails	90 (3.54) (3 rows)	1000 (39.37)	70 (154.32)	NSYSQCR90100
Quick-fixing cross-rails	90 (3.54) (3 rows)	1200 (47.24)	70 (154.32)	NSYSQCR90120
Set of 2 quick cross-rails 120 (4.72) x 400 (15.75) mm (in.)				NSYSQCR12040
Set of 2 quick cross-rails 120 (4.72) x 500 (19.68) mm (in.)				NSYSQCR12050
Set of 2 quick cross-rails 120 (4.72) x 600 (23.62) mm (in.)				NSYSQCR12060
Set of 2 quick cross-rails 120 (4.72) x 800 (31.50) mm (in.)				NSYSQCR12080

Integrated cross-rails

- Used for the creation of structures inside the enclosure.
- Cross-rails available in three sizes: 40 (1.58) mm (in.) (one row), 65 (2.56) mm (in.) (two rows) and 90 (3.54) mm (in.) (three rows).
- Each row is perforated every 25 (0.98) mm (in.) with a 5.2 (0.20) mm (in.) diameter hole and a 11 (0.43) x 13 (0.51) mm (in.) cutout which enables fixing by means of M6 self-tapping screws, ref **NSYST30M6S**.
- Equipment are fixed by means of caged nuts or self-tapping screws
- Material: Zinc-coated steel
- Thickness: 15 (0.59)/10^ø mm (in.)

Fixing to the structure:

Fixing is shifted by 30 (1.18) mm (in.) relatively to uprights axis.
Possibility to mount cross-rails simultaneously on all sides, at the same height of the enclosure.

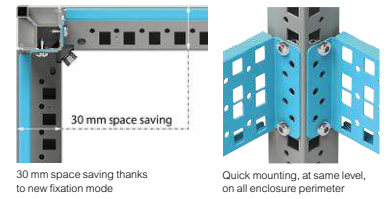

Comment:
For dimensions see [page 308](#)

Supply:
Two cross-rails and fixing elements



Characteristics	Width of the cross-rails mm (in.)	H / L / P (Dn) of enclosure mm (in.)	Maximum load by rail kg (lbs.)	References
Integrated cross-rails	40 (1.58) (1 row)	400 (15.75)	60 (132.28)	NSYSICR4040
Integrated cross-rails	40 (1.58) (1 row)	500 (19.68)	60 (132.28)	NSYSICR4050
Integrated cross-rails	40 (1.58) (1 row)	600 (23.62)	50 (110.23)	NSYSICR4060
Integrated cross-rails	40 (1.58) (1 row)	800 (31.50)	40 (88.18)	NSYSICR4080
Integrated cross-rails	40 (1.58) (1 row)	1000 (39.37)	30 (66.14)	NSYSICR40100
Integrated cross-rails	65 (2.56) (2 rows)	300 (11.81)	110 (242.51)	NSYSICR6530
Integrated cross-rails	65 (2.56) (2 rows)	400 (15.75)	100 (220.46)	NSYSICR6540
Integrated cross-rails	65 (2.56) (2 rows)	500 (19.68)	90 (198.42)	NSYSICR6550
Integrated cross-rails	65 (2.56) (2 rows)	600 (23.62)	80 (176.37)	NSYSICR6560
Integrated cross-rails	65 (2.56) (2 rows)	800 (31.50)	70 (154.32)	NSYSICR6580
Integrated cross-rails	65 (2.56) (2 rows)	1000 (39.37)	50 (110.23)	NSYSICR65100
Integrated cross-rails	90 (3.54) (3 rows)	300 (11.81)	130 (286.60)	NSYSICR9030
Integrated cross-rails	90 (3.54) (3 rows)	400 (15.75)	120 (264.55)	NSYSICR9040
Integrated cross-rails	90 (3.54) (3 rows)	500 (19.68)	120 (264.55)	NSYSICR9050
Integrated cross-rails	90 (3.54) (3 rows)	600 (23.62)	110 (242.51)	NSYSICR9060
Integrated cross-rails	90 (3.54) (3 rows)	800 (31.50)	100 (220.46)	NSYSICR9080
Integrated cross-rails	90 (3.54) (3 rows)	1000 (39.37)	70 (154.32)	NSYSICR90100
Integrated cross-rails	90 (3.54) (3 rows)	1200 (47.24)	70 (154.32)	NSYSICR90120

SM SF SFX Light cross-rails

- **Spacial SF and SFX:** Direct fixing to the structure or between cross-rails.
- **Spacial SM:** Fixing by means of adaptation profiles and 40 (1.58) mm (in.) universal cross-rails (one row), or between cross-rails in any other position.
- Adjustable with a pitch of 25 (0.98) mm (in.).
- The light cross-rails are equipped with a row of drill holes with a diameter of 5.2 (0.20) mm (in.) and a pitch of 25 (0.98) mm (in.), which allows fixing with an M6 self-tapping screw, ref. **NSYST30M6S**.
- Material: Zinc-coated steel

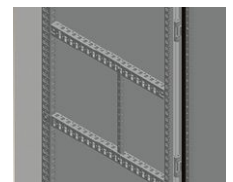

Comment:
For dimensions see [page 308](#)

Supply:
Two light cross-rails and fixing elements



Characteristics	Width/Depth mm (in.)	References
Spacial SF/SFX/SM Light cross-rails	400 (15.75)	NSYSLCR40
Spacial SF/SFX/SM Light cross-rails	500 (19.68)	NSYSLCR50
Spacial SF/SFX/SM Light cross-rails	600 (23.62)	NSYSLCR60
Spacial SF/SFX/SM Light cross-rails	800 (31.50)	NSYSLCR80

SF Rails for heavy loads



- They can be mounted with a cable gland plate or with a previously mounted mounting plate.
- Laterally adjustable with a pitch of 25 (0.98) mm (in.).
- Elongated holes, for adjusting the center-to-center distance of the switchgear.
- Fixing to the structure: Directly fixed on the bottom frame of the enclosure
- Thickness: 30 (1.18)/10^ø mm (in.)
- Material: Galvanized steel

Supply:
Two rails for heavy loads and fixing elements



NSYHLCR40

Characteristics	Maximum load kg (lbs.)	Depth mm (in.)	References
Rail for heavy loads	575 (22.64)	400 (15.75)	NSYHLCR40
Rail for heavy loads	525 (20.67)	500 (19.68)	NSYHLCR50
Rail for heavy loads	500 (19.68)	600 (23.62)	NSYHLCR60
Rail for heavy loads	500 (19.68)	700 (27.56)	NSYHLCR70
Rail for heavy loads	475 (18.70)	800 (31.50)	NSYHLCR80

SF Cross-rail for Lütze chassis

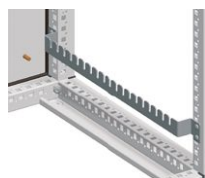
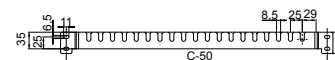

NSYLCR40

- Cross-rail for fixing and adjusting the depth of the Lütze chassis.
- Thickness: 25 (0.98)/10^ø mm (in.)
- Material: Galvanized steel

Supply:
Six cross-rails for Lütze chassis and fixing elements

Characteristics	Depth mm (in.)	References
Cross-rail for Lütze chassis	400 (15.75)	NSYLCR40
Cross-rail for Lütze chassis	500 (19.68)	NSYLCR50
Cross-rail for Lütze chassis	600 (23.62)	NSYLCR60

Support for Lütze chassis

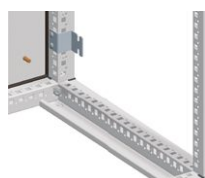
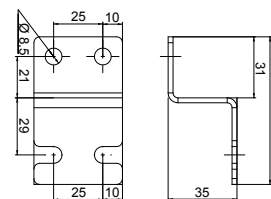

NSYLSUP

- Support for installing Lütze chassis in the back of the enclosure.
- Thickness: 25 (0.98)/10^ø mm (in.)
- Material: Galvanized steel

Comment:
For dimensions see [page 308](#)

Supply:
Six supports and fixing elements

Characteristics	References
Spacial SF Support for Lütze chassis	NSYLSUP

SM Vertical adaptation profiles



NSYSMVR12

- The vertical adaptation profiles provide fixing points at the entrance to the enclosure.
- Fixing on the screws of the hinge and catches of the lock.
- Allows the depthwise fixing of cross-rails, etc.
- Thickness: 15 (0.59)/10^a mm (in.)
- Material: Zinc-coated steel



Comment:
For dimensions see [page 309](#)

Supply:
2 vertical adaptation profiles and fixing screws

Characteristics	Height mm (in.)	References
Vertical adaptation profiles	1200 (47.24)	NSYSMVR12
Vertical adaptation profiles	1400 (55.12)	NSYSMVR14
Vertical adaptation profiles	1600 (62.99)	NSYSMVR16
Vertical adaptation profiles	1800 (70.87)	NSYSMVR18
Vertical adaptation profiles	2000 (78.74)	NSYSMVR20

SM Horizontal adaptation profiles



NSYSMHR6

- The horizontal adaptation profiles provide fixing points at the entrance to the enclosure.
- Thickness: 15 (0.59)/10^a mm (in.)
- Material: Zinc-coated steel



Comment:
For dimensions see [page 309](#)

Supply:
2 horizontal adaptation profiles and fixing screws

Characteristics	Width mm (in.)	References
Horizontal adaptation profiles	600 (23.62)	NSYSMHR6
Horizontal adaptation profiles	800 (31.50)	NSYSMHR8
Horizontal adaptation profiles	1000 (39.37)	NSYSMHR10
Horizontal adaptation profiles	1200 (47.24)	NSYSMHR12
Horizontal adaptation profiles	1600 (62.99)	NSYSMHR16

SM SF Fixed tray

- Provided with cut-outs for improving air circulation inside.
- Material: Steel
- Finish: Painted with epoxy polyester resin
- Color: RAL 7035 grey
- Maximum load: 150 (330.69) kg (lbs.) direct fixed to the structure, 40 (88.18) kg (lbs.) when universal cross-rails are used



Options for fixing the tray to the enclosure:

If the tray has the same dimensions as the enclosure:

- Spacial SF: Direct fixing to the structure.
- Spacial SFX: Installation possible only with universal cross-rails, see [page 254](#).
- Spacial SM: Fixing by means of adaptation profiles and 40 (1.58) mm (in.) universal cross-rails (1 row) in vertical position.

If the tray is smaller than the dimensions of the enclosure:

- Fixing on depth cross-rails.
- Depth-adjustable tray with a pitch of 25 (0.98) mm (in.).

Supply:

1 fixed tray and fixing elements

Characteristics	Depth mm (in.)	Width mm (in.)	References
Fixed tray	400 (15.75)	600 (23.62)	NSYFXT6040
Fixed tray	400 (15.75)	800 (31.50)	NSYFXT8040
Fixed tray	500 (19.68)	600 (23.62)	NSYFXT6050
Fixed tray	500 (19.68)	800 (31.50)	NSYFXT8050
Fixed tray	600 (23.62)	600 (23.62)	NSYFXT6060
Fixed tray	600 (23.62)	800 (31.50)	NSYFXT8060
Fixed tray	800 (31.50)	800 (31.50)	NSYFXT8080

SM SF Telescopic rails

- End-of-travel stop of the rails in open and closed position.
- Material: Zinc-coated steel
- Finish: Painted with epoxy polyester resin
- Maximum load: 25 (55.12) kg (lbs.) evenly distributed



Options for fixing the tray to the enclosure:

- Spacial SF: Installation directly on the structure of the enclosure or on universal cross-rails.
- Spacial SFX: Installation possible only with universal cross-rails, see [page 254](#).
- Spacial SM: Installation by means of adaptation profiles and 40 (1.58) mm (in.) universal cross-rails (1 row) in vertical position, or on horizontal universal cross-rails.

The installation of a telescopic tray consists of the following:

- 1 fixed tray.
- 2 telescopic rails.

Supply:

2 telescopic rails and fixing elements

Characteristics	Depth mm (in.)	Width mm (in.)	References
Telescopic rails	400 (15.75)	600 (23.62) / 800 (31.50)	NSYTTG40
Telescopic rails	500 (19.68)	600 (23.62) / 800 (31.50)	NSYTTG50
Telescopic rails	600 (23.62) / 800 (31.50)	600 (23.62) / 800 (31.50)	NSYTTG60

Handle for telescopic trays

- Designed for easy extraction of the sliding trays.
- Material: Polyamide 6 (black).



Supply:

2 units and fixing elements

Characteristics	References
Handle for telescopic trays	NSY1TH

SM SMX SF SFX Tray cross-rails

- Allow the installation of fixed trays and telescopic rails. Quick and universal cross-rails, see [page 254 - 255](#)

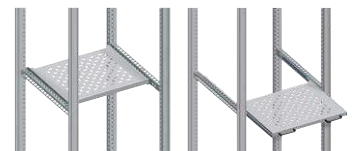
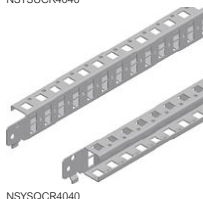
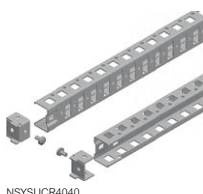

Characteristics	Depth mm (in.)	References
Tray cross-rails, Universal cross-rail, 40 (1.58) mm (in.) (1 row)	400 (15.75)	NSYSUCR4040
Tray cross-rails, Universal cross-rail, 40 (1.58) mm (in.) (1 row)	500 (19.68)	NSYSUCR4050
Tray cross-rails, Universal cross-rail, 40 (1.58) mm (in.) (1 row)	600 (23.62)	NSYSUCR4060
Tray cross-rails, Universal cross-rail, 40 (1.58) mm (in.) (1 row)	800 (31.50)	NSYSUCR4080
Tray cross-rails, Quick-fixing cross-rail, 40 (1.58) mm (in.) (1 row)	400 (15.75)	NSYSQCR4040
Tray cross-rails, Quick-fixing cross-rail, 40 (1.58) mm (in.) (1 row)	500 (19.68)	NSYSQCR4050
Tray cross-rails, Quick-fixing cross-rail, 40 (1.58) mm (in.) (1 row)	600 (23.62)	NSYSQCR4060
Tray cross-rails, Quick-fixing cross-rail, 40 (1.58) mm (in.) (1 row)	800 (31.50)	NSYSQCR4080

SF Heavy load kit

- 4 parts designed to strengthen installation supports (shelves or cross-rails) in case of heavy loads.
- Several kits can be set up in the same enclosure as long as the maximum load of 1000 (2204.62) kg (lbs.) is not exceeded.
- Strengthen the stiffness of the enclosure.
- Supports set up in the depth direction embed cut outs to help secure equipment fixing.
- Material: Steel
- Color: RAL 7035 grey
- Maximum load: Up to 350 (771.62) kg (lbs.)

The kit can be used with following rails:

- Standard crossrails delivered with Spacial SF,
- Quick-fixing cross-rails **NSYSQCR●●●●●**,
- DIN rails **NSYSDR●●** and **NSYDPR●●**,
- **NSYCN●●** rails,
- Heavy load cross-rails **NSYHLCR●●**.

Comment:

Combination examples see [page 309](#)

Supply:

2 cross-rails (front/rear)
+ 2 supports to be mounted according to depth direction



Characteristics	Depth mm (in.)	Width mm (in.)	References
Heavy load kit	400 (15.75)	600 (23.62)	NSYSHLT6040
Heavy load kit	400 (15.75)	800 (31.50)	NSYSHLT8040
Heavy load kit	600 (23.62)	600 (23.62)	NSYSHLT6060
Heavy load kit	600 (23.62)	800 (31.50)	NSYSHLT8060
Heavy load kit	800 (31.50)	600 (23.62)	NSYSHLT6080
Heavy load kit	800 (31.50)	800 (31.50)	NSYSHLT8080

SF Ventilated shelf

- Airing is ensured by two cut-out sizes: 11 (0.43) x 13 (0.51) mm (in.) rectangles for fixation on both sides with self-tapping screws, 40 (1.58) x 8.5 (0.34) mm (in.) rectangles.
- The ventilated shelf must be fixed in the enclosure with a heavy load kit.
- Material: Steel
- Color: RAL 7035 grey
- Maximum load: 350 (771.62) kg (lbs.)



Supply:

1 tray and fixing elements

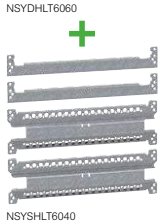
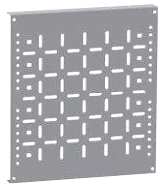

Characteristics	Tray dimensions W x D x H mm (in.)	Depth mm (in.)	Width mm (in.)	References
Ventilated shelf	700 (27.56) x 559 (22.01) x 50 (1.97)	600 (23.62)	800 (31.50)	NSYDHLT6060
Ventilated shelf	700 (27.56) x 759 (29.88) x 50 (1.97)	800 (31.50)	800 (31.50)	NSYDHLT8080

SF Plain shelf for battery

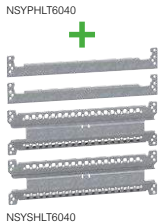

- Painted shelf with rims to avoid potential liquid leakage.
- Electrical continuity is ensured by specific staples.
- Access and replacement (thus maintenance) are eased by mounting brackets.
- The plain shelf must be fixed in the enclosure with a heavy load kit.
- Material: Steel
- Color: RAL 7035 grey
- Maximum load: 350 (771.62) kg (lbs.)

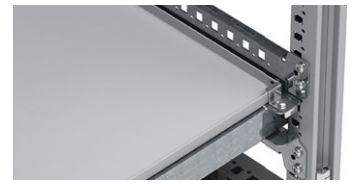

Supply:
1 tray and fixing elements

Characteristics	Tray dimensions W x D x H mm (in.)	Depth mm (in.)	Width mm (in.)	References
Plain shelf for battery	500 (19.68) x 300 (11.81) x 16 (0.63)	400 (15.75)	600 (23.62)	NSYPHLT6040
Plain shelf for battery	700 (27.56) x 300 (11.81) x 16 (0.63)	400 (15.75)	800 (31.50)	NSYPHLT8040
Plain shelf for battery	500 (19.68) x 500 (19.68) x 16 (0.63)	600 (23.62)	600 (23.62)	NSYPHLT6060
Plain shelf for battery	700 (27.56) x 500 (19.68) x 16 (0.63)	600 (23.62)	800 (31.50)	NSYPHLT6080
Plain shelf for battery	500 (19.68) x 700 (27.56) x 16 (0.63)	800 (31.50)	600 (23.62)	NSYPHLT6080
Plain shelf for battery	700 (27.56) x 700 (27.56) x 16 (0.63)	800 (31.50)	800 (31.50)	NSYPHLT8080

SF Heavy load cross-rails

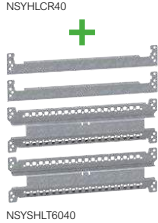

- Can be fixed anywhere in the enclosure with a heavy load kit.
- Free space useful for thermal management.
- Nominal width of cross-rails must be 100 (3.94) mm (in.) shorter than the associated heavy load kit width.
- Material: Steel



Supply:
2 cross-rails and fixing elements

Characteristics	Associated heavy load kit references	Maximum load kg (lbs.)	Nominal width mm (in.)	References
Heavy load cross-rails	Not usable with heavy load kit	575 (22.64)	400 (15.75)	NSYHLCR40
Heavy load cross-rails	NSYSHLT6040 NSYSHLT6060 NSYSHLT6080	525 (20.67)	500 (19.68)	NSYHLCR50
Heavy load cross-rails	Not usable with heavy load kit	500 (19.68)	600 (23.62)	NSYHLCR60
Heavy load cross-rails	NSYSHLT8040 NSYSHLT8060 NSYSHLT8080	500 (19.68)	700 (27.56)	NSYHLCR70
Heavy load cross-rails	Not usable with heavy load kit	475 (18.70)	800 (31.50)	NSYHLCR80

Heavy load supports



Combination examples



• Heavy load kit + Ventilated shelf



• Heavy load kit + Partially ventilated shelf



• Heavy load kit + Plain shelf for battery



• Heavy load kit + Heavy load cross-rails

S3D S3X PLM Symmetric mounting rail for the wall-mounted enclosures

- 2 types: Type A: 35 (1.38) x 15 (0.59) mm (in.), Type B: 35 (1.38) x 7.5 (0.30) mm (in.)
- Material: Zinc-coated steel
- Standards: IEC 715
- Thickness: Type A: 15 (0.59)/10^e mm (in.), Type B: 10 (0.39)/10^e mm (in.)
- Fixing: Fixed to mounting plates or another fixing elements, uprights not included in the supply

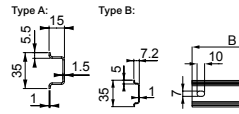

Supply:

10 rails and fixings for direct assembling to the structure. References by unit. Order by multiples of 10 units(10, 20, etc.)



NSYSDR30B

Characteristics	Type	Enclosure width mm (in.)	Rail length mm (in.)	References
Symmetric mounting rail for the wall-mounted enclosures	B	300 (11.81)	250 (9.84)	NSYSDR30B
Symmetric mounting rail for the wall-mounted enclosures	B	400 (15.75)	350 (13.78)	NSYSDR40B
Symmetric mounting rail for the wall-mounted enclosures	A	500 (19.68)	450 (17.72)	NSYSDR50A
Symmetric mounting rail for the wall-mounted enclosures	A	600 (23.62)	550 (21.65)	NSYSDR60A
Symmetric mounting rail for the wall-mounted enclosures	A	800 (31.50)	750 (29.53)	NSYSDR80A
Symmetric mounting rail for the wall-mounted enclosures	A	1000 (39.37)	950 (37.40)	NSYSDR100A

SM SMX SF SFX Symmetric DIN rails for the floor-standing enclosures

SD SDX

- Help ensure horizontal continuity in case of enclosure assembly.
- Rail type: Type A: 35 (1.38) x 15 (0.59) mm (in.).
- Material: Zinc-coated steel
- Standards: IEC 715
- Thickness: 15 (0.59)/10^e mm (in.)
- Fixing: Fixed to the standard or technical uprights (see [page 251](#)) or directly to the structure

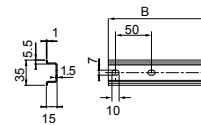

Supply:

10 rails and fixings for direct assembling to the structure. References by unit. Order by multiples of 10 units(10, 20, etc.)



NSYSDR60

Characteristics	Enclosure width mm (in.)	Rail length mm (in.)	References
Symmetric DIN rail for the floor-standing enclosures	600 (23.62)	588 (23.15)	NSYSDR60
Symmetric DIN rail for the floor-standing enclosures	800 (31.50)	788 (31.02)	NSYSDR80
Symmetric DIN rail for the floor-standing enclosures	1000 (39.37)	988 (38.90)	NSYSDR100
Symmetric DIN rail for the floor-standing enclosures	1200 (47.24)	1188 (46.77)	NSYSDR120



Double-profile DIN rails

- They combine the advantages of symmetric and asymmetric rails.
- Quick installation of terminals according to standard DIN 46277/1.
- Material: Zinc-coated steel
- Thickness: 15 (0.59)/10^e mm (in.)
- Fixing: Fixed to the standard or technical upights (see [page 310](#)) or directly to the structure

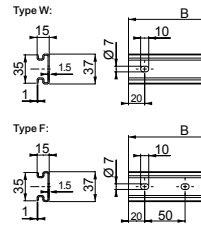

Supply:
10 rails and fixings for direct assembling to the structure. References by unit. Order by multiples of 10 units(10, 20, etc.)



NSYDPR25

Characteristics	Type	Enclosure width mm (in.)	Rail length mm (in.)	References
Double-profile DIN rail, for wall-mounted enclosure	W	300 (11.81)	250 (9.84)	NSYDPR25
Double-profile DIN rail, for wall-mounted enclosure	W	400 (15.75)	350 (13.78)	NSYDPR35
Double-profile DIN rail, for wall-mounted enclosure	W	500 (19.68)	450 (17.72)	NSYDPR45
Double-profile DIN rail, for wall-mounted enclosure	W	600 (23.62)	550 (21.65)	NSYDPR55
Double-profile DIN rail, for floor-standing enclosure	F	600 (23.62)	588 (23.15)	NSYDPR60
Double-profile DIN rail, for wall-mounted enclosure	W	700 (27.56)	650 (25.59)	NSYDPR65
Double-profile DIN rail, for wall-mounted enclosure	W	600 (23.62)	750 (29.53)	NSYDPR75
Double-profile DIN rail, for floor-standing enclosure	F	600 (23.62)	788 (31.02)	NSYDPR80
Double-profile DIN rail, for floor-standing enclosure	F	1000 (39.37)	988 (38.90)	NSYDPR100
Double-profile DIN rail, for floor-standing enclosure	F	1200 (47.24)	1188 (46.77)	NSYDPR120

Serrated C-shaped rail for heavy loads

- Marked in steps of 25 (0.98) mm (in.) to facilitate switchgear positioning.
- Material: Zinc-coated steel
- Thickness: 20 (0.79)/10^e mm (in.)

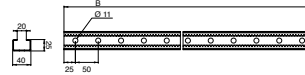

Supply:
2 rails with a length of 2 m



AM1EC200

Characteristics	Rail length mm (in.)	References
Serrated C-shaped rail for heavy loads	2000 (78.74)	AM1EC200

Symmetric C-shaped rails

- Rails for supporting and fixing switchgear on panels and enclosures, formation of chassis, racks and panel reinforcements.
- Material: Galvanized steel
- Fixing: They are fixed to the structure and to one another by means of fixing elements

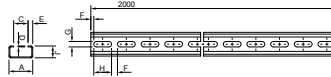

Comment:
For dimensions see [page 310](#)

Supply:
References by unit. Order by multiples of 10 units(10, 20, etc.)



NSYCN20

Characteristics	Rail length mm (in.)	References
Symmetric C-shaped rails 21 (0.83) x 11 (0.43) x 10 (0.39) mm (in.), perforated	2000 (78.74)	NSYCN20
Symmetric C-shaped rails 21 (0.83) x 11 (0.43) x 10 (0.39) mm (in.)	2000 (78.74)	NSYCNT20
Symmetric C-shaped rails 40 (1.58) x 20 (0.79) x 24 (0.94) mm (in.), perforated	2000 (78.74)	NSYCN40
Symmetric C-shaped rails 40 (1.58) x 20 (0.79) x 24 (0.94) mm (in.)	2000 (78.74)	NSYCNT40

Combiplas nut for symmetric C-shaped rails



NSYBN206

Characteristics	Rail type	Nuts type	Supply	References
Combiplas nut for symmetric C-shaped rails	C20	M4	100	NSYBN204
Combiplas nut for symmetric C-shaped rails	C20	M6	100	NSYBN206
Combiplas nut for symmetric C-shaped rails	C40	M4	50	NSYBN404
Combiplas nut for symmetric C-shaped rails	C40	M6	50	NSYBN406
Combiplas nut for symmetric C-shaped rails	C40	M8	50	NSYBN408
Combiplas nut for symmetric C-shaped rails	C60	M6	20	NSYBN606
Combiplas nut for symmetric C-shaped rails	C60	M8	20	NSYBN608
Combiplas nut for symmetric C-shaped rails	C60	M10	20	NSYBN610

Metal sliding nut for symmetric C-shaped rails



NSYB204

Characteristics	Rail type	Nuts type	Supply	References
Metal sliding nut for symmetric C-shaped rails	C20	M4	100	NSYB204
Metal sliding nut for symmetric C-shaped rails	C40	M4	100	NSYB404
Metal sliding nut for symmetric C-shaped rails	C40	M6	-	NSYB406

2000 (78.74) mm (in.) Rails

Symmetric rails

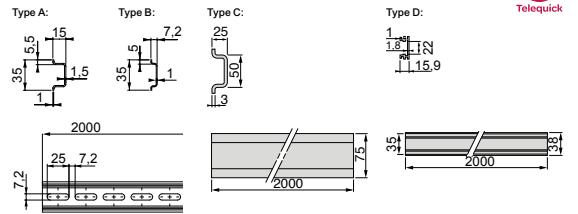

- Material: Galvanized steel, zinc-coated steel or aluminum
- Length: 2000 (78.74) mm (in.)



NSYSDR200D

Characteristics	Type	Order by Multiples	Perforations	References
Symmetric rail, Galvanized steel	A	10	Perforated	NSYSDR200D
Symmetric rail, Galvanized steel	B	10	Perforated	NSYSDR200BD
Symmetric rail, Galvanized steel	A	10	Not perforated	NSYSDR200
Symmetric rail, Galvanized steel	B	10	Not perforated	NSYSDR200B
Symmetric rail, Zinc-coated steel	C	6	Not perforated	AM1DL201
Symmetric rail, Aluminum	D	10	Not perforated	AM1EA200

Asymmetric DIN rails

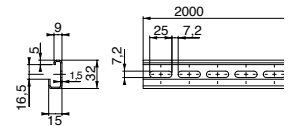

- Material: Galvanized steel
- Length: 2000 (78.74) mm (in.)



NSYADR200D

Supply:
20 rails with a length of 2 (78.74) m (in.).
References by unit. Order by multiples of 20 units (20, 40, etc.)

Characteristics	Perforations	References
Asymmetric DIN rail	Perforated	NSYADR200D
Asymmetric DIN rail	Not perforated	NSYADR200

Double-profile DIN rails

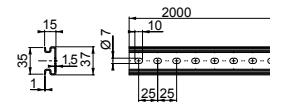

- Material: Galvanized steel
- Length: 2000 (78.74) mm (in.)



NSYDPR200D

Supply:
20 rails with a length of 2 (78.74) m (in.).
References by unit. Order by multiples of 20 units (20, 40, etc.)

Characteristics	Thickness mm (in.)	Perforations	Order by Multiples	References
Double-profile DIN rail	15 (0.59)/10 ⁶ mm (in.)	Perforated	10	NSYDPR200D
Double-profile DIN rail	10 (0.39)/10 ⁶ mm (in.)	Perforated	20	NSYDPR200T
Double-profile DIN rail	15 (0.59)/10 ⁶ mm (in.)	Not perforated	10	NSYDPR200

Nuts for symmetric rails



AF1GC4

- Clip-on nut.

Characteristics	Type	References
Nuts for symmetric rails	M4	AF1GC4
Nuts for symmetric rails	M5	AF1GC5
Nuts for symmetric rails	M6	AF1GC6

Supply:
100 nuts



Nuts for asymmetric DIN rails, 2000 (78.74) mm (in.) version



DZ5ME5

- Quarter-turn sliding nut.

Characteristics	Type	References
Nuts for asymmetric DIN rails, 2000 (78.74) mm (in.) version	M4	DZ5ME5
Nuts for asymmetric DIN rails, 2000 (78.74) mm (in.) version	M5	DZ5ME8
Nuts for asymmetric DIN rails, 2000 (78.74) mm (in.) version	M6	DZ5ME9

Supply:
100 nuts



Nuts for double-profile DIN rails



AF1CF34

- Quarter-turn sliding nut.

Characteristics	Type	References
Nuts for double-profile DIN rails	M3 + M4	AF1CF34
Nuts for double-profile DIN rails	M5 + M6	AF1CF56

Supply:
100 nuts



Nuts for serrated C-shaped rails



NSYSNM6

- Quarter-turn sliding nuts.

Characteristics	Type	References
M6 quarter-turn sliding nut	M6	NSYSNM6
M8 quarter-turn sliding nut	M8	NSYSNM8
M6 quarter-turn serrated sliding nut	M6	NSYSNSM6
M8 quarter-turn serrated sliding nut	M8	NSYSNSM8

Supply:
10 nuts



NSYSNSM6

Connectors for Symmetric C-Shaped Rails

- The connectors enable the formation of chassis or frames and structures for fixing switchgear, in any position inside the enclosures, allowing the fixing of DIN rails or other elements.
- See symmetric C-shaped rails.

EMA connectors



NSYEMA20

- To join two symmetric C-shaped rails, C20 and C40 types, at right angles; They can also be used to obtain a T-shaped assembly.
- Material: Zinc-coated steel
- Thickness: 20 (0.79)/10^ø mm (in.)

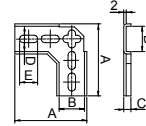

Comment:
Dimensions
see [page 311](#)

Supply:
20 units. References by unit. Order by multiples of 20 units (20, 40, 60, etc.)

Characteristics		References
EMA connectors		NSYEMA20
EMA connectors		NSYEMA40

EVA connectors



NSYEVA20

- To join two symmetric C-shaped rails, C20 and C40 types, forming an overlapping assembly with plane change, or also at right angles for the formation of spacers or supports at a different level.
- Material: Zinc-coated steel

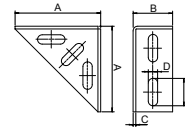

Comment:
Dimensions
see [page 311](#)

Supply:
20 units. References by unit. Order by multiples of 20 units (20, 40, 60, etc.)

Characteristics		References
EVA connectors		NSYEVA20
EVA connectors		NSYEVA40

UCA connectors



NSYUCA22

- To join symmetric C-shaped rails, types C20 and C40, forming a cross-shaped assembly of three rails located on the same plane, for example inside a frame.
- Material: Zinc-coated steel

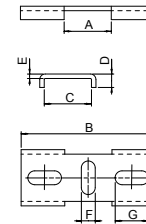

Comment:
Dimensions
see [page 312](#)

Supply:
20 units. References by unit. Order by multiples of 20 units (20, 40, 60, etc.)

Characteristics		References
UCA connectors		NSYUCA22
UCA connectors		NSYUCA44

UTA connectors



NSYUTA22

- To create a T-shaped assembly between two symmetric C-shaped rails, C20 and C40 types, especially recommended for forming crossbars on chassis and frames.
- The **UTA42** connectors type allows C20 rails to be joined with C40 rails.
- Material: Zinc-coated steel

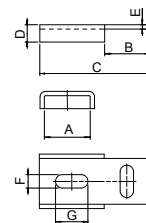

Comment:
Dimensions
see [page 312](#)

Supply:
20 units. References by unit. Order by multiples of 20 units (20, 40, 60, etc.)

Characteristics		References
UTA connectors		NSYUTA22
UTA connectors		NSYUTA42
UTA connectors		NSYUTA44

Connectors for Symmetric C-Shaped Rails

ECA connectors



NSYECA22

- To form a cross-shaped assembly with two symmetric C-shaped rails, C20 and C40 types, located perpendicularly on different planes.
- The **ECA42** connector type makes it possible to join C20 rails with C40 rails.
- Material: Zinc-coated steel

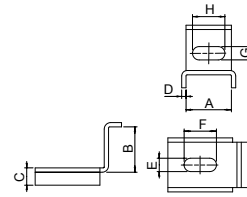

Comment:
Dimensions
see [page 312](#)

Supply:
20 units. References by unit. Order by multiples of 20 units (20, 40, 60, etc.)

Characteristics		References
ECA connectors		NSYECA22
ECA connectors		NSYECA42
ECA connectors		NSYECA44

UR connectors



NSYUR20

- For rectilinear joining of symmetric C-shaped rails.
- Recommended when the standard length is not sufficient or for maximising fractions.
- Material: Zinc-coated steel

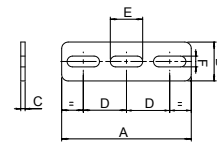

Comment:
Dimensions
see [page 312](#)

Supply:
20 units. References by unit. Order by multiples of 20 units (20, 40, 60, etc.)

Characteristics		References
UR connectors		NSYUR20
UR connectors		NSYUR40
UR connectors		NSYUR60

UT connectors



NSYUT20

- To form T-shaped assemblies between symmetric C-shaped rails.
- They are used to form crossbars on frames and structures.
- Material: Zinc-coated steel

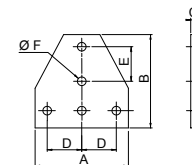

Comment:
Dimensions
see [page 312](#)

Supply:
20 units. References by unit. Order by multiples of 20 units (20, 40, 60, etc.)

Characteristics		References
UT connectors		NSYUT20
UT connectors		NSYUT40
UT connectors		NSYUT60

EN connectors



NSYEN20

- To create L-shaped assemblies with plane change in the symmetric C-shaped rails, between them or with any other section.
- Material: Zinc-coated steel

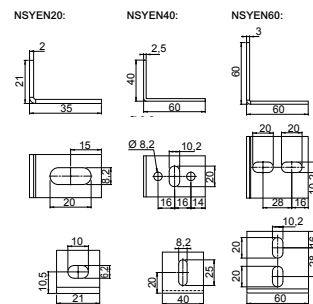

Comment:
Dimensions
see [page 312](#)

Supply:
20 units. References by unit. Order by multiples of 20 units (20, 40, 60, etc.)

Characteristics		References
EN connectors		NSYEN20
EN connectors		NSYEN40
EN connectors		NSYEN60

Hexagonal spacers

- Hexagonal spacers for raising switchgear, mounting plates, etc. They can be linked to achieve variable heights with gradual elevation.
- Their assembly requires M6 or M8 caged nuts.
- Material: Zinc-coated steel
- Installation: If used to raise a mounting plate, the maximum load of the mounting plate is decreased

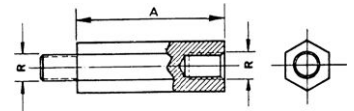

Supply:
100 hexagonal connectors.
References by unit.
Order by multiples of 100 units
(100, 200, 300, etc.)



NSYE1025

Characteristics	Thread type	Spacer height mm (in.)	References
Hexagonal spacers	M5	10 (0.39)	NSYE1025
Hexagonal spacers	M5	15 (0.59)	NSYE1525
Hexagonal spacers	M5	20 (0.79)	NSYE2025
Hexagonal spacers	M6	10 (0.39)	NSYEX106
Hexagonal spacers	M6	12 (0.47)	NSYEX126
Hexagonal spacers	M6	14 (0.55)	NSYEX146
Hexagonal spacers	M6	16 (0.63)	NSYEX166
Hexagonal spacers	M6	18 (0.71)	NSYEX186
Hexagonal spacers	M6	20 (0.79)	NSYEX206
Hexagonal spacers	M6	30 (1.18)	NSYEX306
Hexagonal spacers	M6	40 (1.58)	NSYEX406
Hexagonal spacers	M6	50 (1.97)	NSYEX506
Hexagonal spacers	M6	100 (3.94)	NSYEX1006
Hexagonal spacers	M8	15 (0.59)	NSYEX158
Hexagonal spacers	M8	20 (0.79)	NSYEX208
Hexagonal spacers	M8	30 (1.18)	NSYEX308
Hexagonal spacers	M8	40 (1.58)	NSYEX408
Hexagonal spacers	M8	50 (1.97)	NSYEX508
Hexagonal spacers	M8	60 (2.36)	NSYEX608
Hexagonal spacers	M8	100 (3.94)	NSYEX1008

ETU modular spacers

- Modular spacers for installing devices or rails at a different level from that achieved with the basic chassis or mounting plate.
- Material: Zinc-coated steel

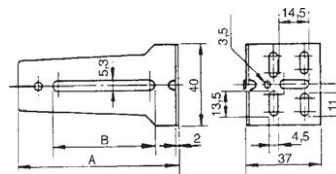

Note:
Combination of spacers
see [page 313](#)

Supply:
20 units. References by unit.
Order by multiples of 20 units
(20, 40, 60, etc.)



NSYETU48

Characteristics	A mm (in.)	B mm (in.)	References
ETU modular spacers	48 (1.89)	25 (0.98)	NSYETU48
ETU modular spacers	58 (2.28)	25 (0.98)	NSYETU58
ETU modular spacers	79 (3.11)	55 (2.16)	NSYETU79
ETU modular spacers	118 (4.65)	55 (2.16)	NSYETU118

S3D S3X 19" fixed chassis for wall-mounted enclosure

- 19" fixed chassis comprising 2 19" uprights with fixing.
- Adjustable in depth by fixing on the step slides available as accessory.
- Material: Galvanized steel
- Thickness: 20 (0.79)/10^o mm (in.)
- Maximum load: 3 (6.61) kg (lbs.) per unit



Characteristics	Enclosure dimensions mm (in.)		Unit number	References
	Height	Width		
19" fixed chassis for wall-mounted enclosure	400 (15.75)	600 (23.62)	8	NSYVDM8UF
19" fixed chassis for wall-mounted enclosure	600 (23.62)	600 (23.62)	12	NSYVDM12UF
19" fixed chassis for wall-mounted enclosure	800 (31.50)	600 (23.62)	17	NSYVDM17UF
19" fixed chassis for wall-mounted enclosure	1000 (39.37)	600 (23.62)	21	NSYVDM21UF

S3D S3X 19" swing chassis for wall-mounted enclosure

- 19" swing chassis opening to 120° with locking system by 3 (0.12) mm (in.) double-bar insert.
- Material: Steel
- Finish: Structured finish, epoxy polyester powder
- Color: RAL 7035 grey
- Maximum load: 3 (6.61) kg (lbs.) per unit



Characteristics	Enclosure dimensions mm (in.)		Unit number	References
	Height	Width		
19" swing chassis for wall-mounted enclosure	400 (15.75)	600 (23.62)	7	NSYVDM7UP
19" swing chassis for wall-mounted enclosure	600 (23.62)	600 (23.62)	11	NSYVDM11UP
19" swing chassis for wall-mounted enclosure	800 (31.50)	600 (23.62)	16	NSYVDM16UP
19" swing chassis for wall-mounted enclosure	1000 (39.37)	600 (23.62)	20	NSYVDM20UP
19" swing chassis for wall-mounted enclosure	1000 (39.37)	800 (31.50)	20	NSYVDM20U8P
19" swing chassis for wall-mounted enclosure	1200 (47.24)	800 (31.50)	25	NSYVDM25U8P

Fixings for 19" rack

- They allow 19" accessories to be mounted.
- Caged nut compatible with 8.5 (0.34) x 8.5 (0.34) mm (in.) and 9.5 (0.37) x 9.5 (0.37) mm (in.) holes.







Characteristics	Set of	References
M6 screws + washers + nuts 8.5 (0,33) mm (in.)	30	NSYGFR95M63
M6 x 16 screws and washers	50	NSYGFR166P
M6 caged nuts 9.5 (0,37) mm (in.)	100	NSYCN9M625
M6 screws + washers + nuts 9.5 (0,37) mm (in.)	50	NSYGFR95M65
M5 screws + washers + nuts 9.5 (0,37) mm (in.)	50	NSYGFR95M55
M6 12 (0.47) mm (in.)	50	NSYGFR12M65

Nuts and Screws Overview

Characteristics		Clip-on nuts						Combiplas slide nuts		Screws with captive washer		
												
Usage	For Telequick mounting plates	C - shaped rail - 20 (0.79)/40 (1.58)/ 60 (2.36) mm (in.)						Hexagonal head			All nuts	
												
Type	Supply	References	Rail type	Supply	References	Supply	References	Models mm (in.)	Supply	References		
M3	100	AF1EA3	-	-	-	-	-	-	-	-		
M4	100	AF1EA4	C20	100	NSYBN204	100	NSYB204	M4 x 10 (0.39)	100	AF1VA410		
M4	100	AF1EA4	C40	100	NSYBN404	100	NSYB404	M4 x 16 (0.63)	100	AF1VA416		
M5	100	AF1EA5	-	-	-	-	-	M5 x 12 (0.47)	100	AF1VA512		
M5	100	AF1EA5	-	-	-	-	-	M5 x 18 (0.71)	100	AF1VA518		
M6	100	AF1EA6	C20	100	NSYBN206	-	-	M6 x 12 (0.47)	100	AF1VA612		
M6	100	AF1EA6	C40	100	NSYBN406	-	-	M6 x 18 (0.71)	100	AF1VA618		
M6	100	AF1EA6	C60	100	NSYBN606	100	NSYB406	-	-	-		
M8	-	-	C40	100	NSYBN408	-	-	M8 x 20 (0.79)	100	AF1VC820		
M8	-	-	C60	100	NSYBN608	-	-	-	-	-		
M10	-	-	C60	100	NSYBN610	-	-	-	-	-		



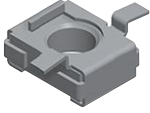

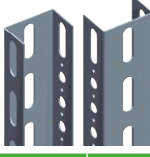

Supply:

References by unit. Order by multiples of the units specified in the supply.

Characteristics		Fixings and nuts for serrated uprights					Nuts for uprights and cross-rails				
											
	Fixing brackets	1/4 turn	Serrated 1/4 turn	Removable nut	Cage nut						
Usage	2 x serrated mounting uprights for floor-standing enclosures										
											
Type	Supply	References	Supply	References	References	Supply	References	Supply	References		
M4	4	NSYMF8	-	-	-	-	-	-	-		
M5	-	-	-	-	-	-	-	-	-		
M6	-	-	10	NSYSNM6	NSYSNSM6	50	NSYCNM6	50	NSYCNFM6		
M8	-	-	10	NSYSNM8	NSYSNSM8	50	NSYCNM8	50	NSYCNFM8		
-	-	-	-	-	-	-	-	-	-		
-	-	-	-	-	-	-	-	-	-		

Supply:





References by unit. Order by multiples of the units specified in the supply.

Torx screws			Self-tapping screw			Fixings and nuts for aluminum uprights			
									
Nuts and 6 (0.24) mm (in.) Spacial enclosures holes			Mounting uprights for wall-mounted enclosures						
									
Models mm (in.)	Supply	References	Models mm (in.)	Supply	References	Supply	References	Supply	References
-	-	-	-	-	-	-	-	4	NSYAMCSF
-	-	-	-	-	-	100	NSYNM4	-	-
-	-	-	M5 x 13 (0.51)	100	NSYS13M5HS	100	NSYNM5	-	-
-	-	-	M5 x 16 (0.63)	100	NSYS16M5HS	-	-	-	-
T30 M6 x 16 (0.63)	100	NSYST30M6	M6 x 16 (0.63)	100	NSYS16M6HS	100	NSYNM6	-	-
T30 M6 x 12 (0.47) self-tapping	100	NSYST30M6S	-	-	-	-	-	-	-
T40 M8 x 16 (0.63)	100	NSYST40M8	-	-	-	-	-	-	-
-	-	-	-	-	-	-	-	-	-
-	-	-	-	-	-	-	-	-	-

Flat nuts for standard uprights		Clip nut for symmetric DIN rail		Quarter turn nut for double profile DIN rail			Quarter turn nut for asymmetric DIN rail	
								
2 x standard mounting uprights for floor-standing enclosures		35 (1.38) x 15 (0.59) mm (in.) symmetric DIN rail		35 (1.38) mm (in.) double profile DIN rail			35 (1.38) mm (in.) asymmetric DIN rail	
								
Supply	References	Supply	References	Models	Supply	References	Supply	References
-	-	100	AF1CG4	-	-	-	100	DZ5ME5
-	-	100	AF1CG5	-	-	-	100	DZ5ME8
50	NSYFNM6	100	AF1CG6	-	-	-	100	DZ5ME9
50	NSYFNM8	-	-	-	-	-	-	-
-	-	-	-	M3 + M4	100	AF1CF34	-	-
-	-	-	-	M5 + M6	100	AF1CF56	-	-

Multiple Cable Entries Overview



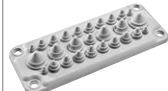

• For details, type the reference in the search engine of www.se.com.

Characteristics	Multi-A	Multi-C	Multi-R	Multi-CS	Multi-T
					
	FL13 and FL21 type membranes.	Circular connector-free entries.	Rectangular connector-free entries.	Modular entry allowing the passing of up to 48 pre-assembled cables.	FL21-type membranes.
Material	TPE, SBS, SEBS and PP co-polymer - Halogen-free	Polyamide	Polyamide	Reinforced polypropylene and TPE. Halogen-free	TPE
Color	RAL 7035 grey	-	-	Black	RAL 7035 grey
Cable entry material	Combined	Soft membrane			
Cable glands to be fitted	Optional: Specific cable clamp ref. NSYAECPLACA●● to be used	No	No	No	No
Installation options	On cable gland plate adapter or directly on enclosure	On modified cable gland plate or directly on enclosure	On cable gland plate with special cut-out or directly on enclosure	On cable gland plate adapter or directly on enclosure	
Flexibility of the installation	Medium	Medium	Medium	Full	Medium
Reversibility	Medium	Full	Full	Full	Medium
Ingress protection rating	IP65 according to IEC 60529	IP65 according to IEC 60529	IP65 according to IEC 60529	IP65 according to IEC 60529	IP66 according to IEC 60529*
Cable retention	High with cable clamp, (up to 18 daN)	Medium	Medium	Medium	Low
Cable diameter mm (in.)	From 13 (0.51) to 30 (1.18) mm (in.)	From 3 (0.12) to 15.9 (0.63) mm (in.)	From 4.3 (0.17) to 15.9 (0.63) mm (in.)	Up to 22 (0.87) mm (in.)	From 5 (0.20) to 60 (2.36) mm (in.)
Cable Installation time	Medium	Fast	Fast	Fast	Fast
Quantity of cables to be fitted for a given surface	++	++	++	+++	++
Cable entries for cables with connectors	No	No	No	Yes	No
Cut-out dimensions mm (in.)	134 (5.28) x 52 (2.05) mm (in.) (FL13) 214 (8.42) x 90 (3.54) mm (in.) (FL21)	Ø 50.5 (1.99) mm (in.) Ø 63.5 (2.50) mm (in.)	112 (4.41) x 36 (1.42) mm (in.)	112 (4.41) x 36 (1.42) mm (in.)	214 (8.42) x 90 (3.54) mm (in.) (FL21)
External dimensions mm (in.)	216 (8.50) x 84 (3.31) mm (in.)	Ø 58 (2.28) mm (in.) Ø 71 (2.80) mm (in.)	146 (5.75) x 14 (0.55) x 58 (2.28) mm (in.)	148 (5.83) x 58 (2.28) x 15 (0.59) mm (in.) 148 (5.83) x 58 (2.28) x 18 (0.71) mm (in.)	214 (8.42) x 88 (3.46) mm (in.)
Certificates	Cable anchorage pull test: EN 50262. Long term UV- resistance: ASTM G 154-06	UL 94 V-0	UL 94 V-0	<ul style="list-style-type: none"> UL 94 V-0 Fire resistance: V0 	UL 94 V-0
Fire resistance	750°C (1382°F)	650°C (1202°F)	650°C (1202°F)	-	650°C (1202°F)
Temperature range	-40°C (-40°F) to +85°C (185°F)	-	-	-30°C (-22°F) to +100°C (212°F)	-40°C (-40°F) to +100°C (212°F)
References	See page 280 NSYAECPLA●●	See page 280 NSYTSAM●●●●●	See page 281 NSYSA24●●●●●	See page 282 NSYDCD24●●	See page 281 NSYAECPL●●●

* IP65 for **NSYAECPLBP**.

Multiple Cable Entries Overview





• For further information please have a look on the next page



Characteristics	Multi-F	Multi-CF	Multi-CR	Multi-H
				
	FL13 and FL21 pre-configured flanges.	Cable entry for protected cables.	Cable entries with dies for cables equipped with connectors.	FL21 insulated flange with ISO knock-outs.
Material	Fiberglass-reinforced polypropylene and TPE - Calogen Free	Reinforced polypropylene and TPE. Halogen-free	Polyamide	Polycarbonate glass-fiber reinforced
Color	RAL 7035 grey	Black	-	RAL 7035 grey
Cable entry material	Soft membrane		Hard plastic	
Cable glands to be fitted	No	No	Yes	Yes
Installation options	On cable gland plate adapter or directly on enclosure			
Flexibility of the installation	Medium	Full	Low	Low
Reversibility	Medium	Full	Medium	Medium
Ingress protection rating	IP65 according to IEC 60529	IP65 according to IEC 60529	IP54 according to IEC 60529	IP65 according to IEC 60529
Cable retention	Low	Medium	High (with fastener)	High (with cable clamp)
Cable diameter (m)	From 16 to 50	From 9 to 30	From 3 to 31	From 12 to 25
Cable Installation time	Fast	Fast	Slow	Slow
Quantity of cables to be fitted for a given surface	++	+++	++	++
Cable entries for cables with connectors	No	Yes	Yes	No
Cut-out dimensions mm (in.)	134 (5.28) x 52 (2.05) mm (in.) (FL13) 214 (8.42) x 90 (3.54) mm (in.) (FL21)	112 (4.41) x 36 (1.42) mm (in.)	36 (1.42) x 91 (3.58) mm (in.) (NSYDCE168) 36 (1.42) x 112 (4.41) mm (in.) (NSYDCE24•)	214 (8.42) x 90 (3.54) mm (in.) (FL21)
External dimensions mm (in.)	From 134 (5.28) x 52 (2.05) mm (in.) to 214 (8.42) x 90 (3.54) mm (in.)	148 (5.83) x 60 (2.36) x 10 (0.39) mm (in.)	146 (5.75) x 58 (2.28) mm (in.)	21 (0.83) x 85 (3.35) mm (in.)
Certificates	<ul style="list-style-type: none"> UL 94-HB Test standard EN 60529:1991 + A1 EN 60670-1:2005, EN 50262:1998 EMKO-TUI (03-SEC) F1001/84. Semko report 816003 UL-approved materials 	<ul style="list-style-type: none"> UL 94-HB Fire resistance: V0 	-	UL 94 V-1
Flame resistance	-	-	650°C (1202°F)	750°C (1382°F)
Temperature range	-20°C (-4°F) to +125°C (257°F) "Pop-out" membranes only.	-30°C (-22°F) to +70°C (158°F)	-40°C (-40°F) to +80°C (176°F)	<ul style="list-style-type: none"> For normal operation: -40°C (-40°F) to +80°C (176°F) For a short time: -40°C (-40°F) to +120°C (248°F)
References	See page 281 NSYAECPKFL●●	See page 283 NSYTLK24●●	See page 282 NSYDCE●●●●	See page 281 NSYTSKFL

Technical changes reserved. Information provided without guarantee. Images are for illustrative purposes only.





Simple Cable Entries Overview

• For details, type the reference in the search engine of www.se.com.

Characteristics	Simple-1	Simple-2	Simple-3	Simple-4	Simple-5
					
	Mixed membrane entries for enclosure thickness 20 (0.79)/10° mm (in.) - 32 (1.26)/10° mm. (in.)	PVC adjustable cone-shaped entries for enclosure thickness 30 (1.18)/10° mm (in.) - 32 (1.26)/10° mm (in.).	Quick cable entries for enclosure thickness 10 (0.39)/10° mm (in.) - 40 (1.58)/10° mm (in.) (0/0.00)/10° mm (in.) - 20 (0.79)/10° mm (in.) for ref. IMT36179).	PVC adjustable cone-shaped entries for PG tubes or for enclosure thickness 12 (0.47)/10° mm (in.) - 15 (0.59)/10° mm (in.).	ISO cable gland.
Material	SBS	PVC	EPDM plastic	PVC	PA6 Polyamide, neoprene gasket
Color	RAL 7035 grey or RAL 9010 white	-	Grey cable entries: NCS 5500 Black cable entries: NCS 9000	Black	RAL 7035 grey
Cable entry material	Soft membrane		Combined		
Cable glands to be fitted	Not applicable				
Installation options	On cable gland plate or directly on enclosure				
Flexibility of the installation	Low				
Reversibility	Medium				
Ingress protection rating	IP55 according to IEC 60529	IP55 according to IEC 60529	IP67 according to IEC 60529	IP55 according to IEC 60529	IP68 according to IEC 60529
Cable retention	Low	Low	Medium	Low	High
Cable diameter mm (in.)	From 20 (0.79) to 40 (1.58) mm (in.)	From 5 (0.20) to 87 (3.42) mm (in.)	From 12 (0.47) to 50 (1.97) mm (in.)	From Ø 13 (0.51) to Ø 44 (1.73) mm (in.)	From 12 (0.47) to 40 (1.58) mm (in.)
Cable Installation time	Fast	Fast	Fast	Fast	Slow
Quantity of cables to be fitted for a given surface	+	+	+	+	+
Cable entries for cables with connectors	No	No	No	No	No
Cut-out dimensions mm (in.)	Various circular hole diameters according to cable diameter				
External dimensions mm (in.)	From Ø 23 (0.91) to 44 (1.73) mm (in.)	From Ø 25 (0.98) to 98 (3.86) mm (in.)	From Ø 12.5 (0.49) to 50.7 (2.00) mm (in.)	52 (2.05) mm (in.)	From Ø 15 (0.59) to 46 (1.81) mm (in.)
Certificates	-	-	-	-	Glow wire resistance: 960°C (1760°F)
Standard	-	-	-	-	Compliance with VDE, UL and CSA
Flame resistance	750°C (1382°F)	-	750°C (1382°F)	-	750°C (1382°F)
References	See page 285 IMT36●●●/1 SM71●●●	See page 285 NSYECPC●●	See page 286 IMT361●●	See page 286 NSYEC●	See page 286 ISM71●●●

Characteristics	Synthetic snap-in cable gland	Stainless-steel cable gland with lamellar insert
		
	Without thread. Easy assembly and disassembly. Suitable for walls from 0.5 (0.02) to 4 (0.16) mm (in.) thick.	Lamellar technology provides excellent resistance to traction as well as excellent torsional protection. For outdoor use, or for aggressive environments.
Material	PA6 Polyamide, neoprene gasket	Stainless-steel AISI 304L or AISI 316L, neoprene gasket
Color	RAL 7035 grey, RAL 7001, RAL 9005. Other colors on demand	-
Cable entry material	Non armoured	Non armoured
Installation options	On cable gland plate or directly on enclosure	
Flexibility of the installation	Low	
Reversibility	Medium	
Ingress protection rating	IP68	
Cable retention	High	
Cable diameter mm (in.)	From 16 (0.63) to 40 (1.58) mm (in.)	From 12 (0.47) to 40 (1.58) mm (in.)
Cable Installation time	Slow	
Quantity of cables to be fitted for a given surface	+	
Cable entries for cables with connectors	No	
Thread type	Metric EN 60423, other types are available on demand	Metric EN 60423
Cut-out dimensions mm (in.)	Various circular hole diameters according to cable diameter	
External dimensions mm (in.)	From Ø 22 (0.87) to 46 (1.81) mm (in.)	From Ø 14 (0.55) to 43 (1.69) mm (in.)
Certificates	UL 94 V-2	
Standard	DIN EN 62444, UL 514B, UL 514B§8.26.7	
Temperature range	-20°C (-4°F) to + 100°C (212°F)	
References	See page 287, NSYCGSP●●	See page 295 NSYCGX●●●

Technical changes reserved. Information provided without guarantee. Images are for illustrative purposes only.

Characteristics	Multi-cable disc	Cable gland gasket	Blanking plug	Transport plug	
					
	The multi-cable bushing permits several cables to be passed through a single cable gland.		It is screwed into the cable gland's plate.	It is installed to block the cable gland during transport or during maintenance operations.	
Material	EDPM rubber	EDPM rubber	PA6	PA6	
Color	Black	Black	RAL 7035 grey	Black	
Ingress protection rating	-	IP68	-	-	
Standards	-	-	-	-	
Other characteristics	-	-	-	-	
Supply	Set of 40 (M16 and M20), 20 (M25 and M32)	Set of 100 (M12 to M20), 50 (M25 and M32), 25 (M40)	Pack of 40 plugs (M12 to M20), 20 plugs (M25 and M32), 10 plugs (M40)	Pack of 40 plugs (M16 to M20), pack of 20 (M25 and M32), pack of 10 (M40)	
Ø	Number / Ø mm (in.)	References	References	References	References
M12	-	-	IMT36151	IMT36161	-
M16	2 x Ø 4 (0.16) mm (in.)	IMT36157	IMT36152	IMT36162	IMT36167
M20	3 x Ø 4 (0.16) mm (in.)	IMT36158	IMT36153	IMT36163	IMT36168
M25	4 x Ø 5 (0.20) mm (in.)	IMT36159	IMT36154	IMT36164	IMT36169
M32	6 x Ø 5 (0.20) mm (in.)	IMT36160	IMT36155	IMT36165	IMT36170
M40	-	-	IMT36156	IMT36166	IMT36171

Key features when selecting a cable entry (1/4)

1



Multiple



Single

Multiple cable entries or single cable entries?

- This choice depends on the number of cables going through the cable entry: Generally, for 3 or more cables, choose a multiple cable entry. This will make your installation faster and more economical.
- In other words, your final costs will not necessarily be lower if you use single cable entry!
- Flexibility of installation: For high flexibility, multiple cable entry is the right choice.

2

Cable entry material

- **Soft membranes** allow cables to be easily pushed through, but still offer a good IP rating and protection from moisture and physical intrusion. Cable retention force, however, is lower than with other alternatives.



Push the membrane into a standard hole.



Make a small hole in the membrane.



Push the cable or tube through the guide hole.



Pull the cable or tube back some 20 (0.79) mm (in.) to lock it.

- **Hard-plastic cable entry plates** require tools to create the opening (drill or knife) but, thanks to the cable gland, they offer a very high retention force. Another use of this solution is for public places, since the hard surface prevents objects being pushed in.

- **Combined:** The material of the cable entry plate is hard plastic, but the cable is pushed through a soft membrane. In this case you have the advantages of both soft membranes (easy and fast installation, flexibility) and hard-plastic membranes (high retention force when using specific cable clamps).



10

3



Cable glands to be fitted

- Some multiple cable entries require a cable gland to be able to retain the cables and ensure the degree of protection

Key features when selecting a cable entry (2/4)

4



Installation options

There are 4 ways to install your cable entries on the enclosure:

- **Using a cable entry:**

The standard cable gland plate of your S3D wall-mounted enclosure is unscrewed and replaced by the cable entry. A gasket between enclosure and cable entry will help ensure good water and dust tightness.



- **Modifying the standard cable gland plate:**

The standard cable gland plate is unscrewed and machined. A cut-out is made.

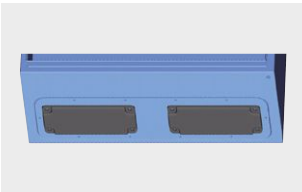

- **On cable gland plate adapter:**

This plate, which has the outer dimensions of a standard cable gland plate, has one or more pre-cut cut-outs of standard dimensions (FL13 and FL21).

On steel wall-mounted enclosures, the plate can replace the standard cable gland plate once the cable entry is fitted into it. On polyester enclosures, a cut-out must be created. Schneider Electric provides this service: a precise laser cut-out can be made at the factory upon request.

On steel floor-standing enclosures, you may either use the specific cable gland roof or create a cut-out (see expert's tip 1 - page 279).

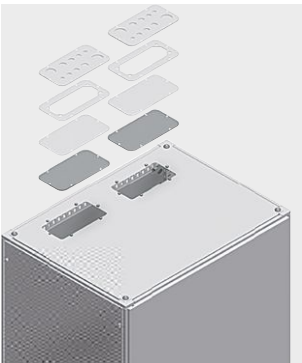

Cable gland plate adapters				
Enclosure range	1 membrane	2 membranes	3 membranes	4 membranes
Spacial S3D	 NSYTL●FL	 NSYTL●2FL	-	 NSYTLG4FL

- **Drilling directly the enclosure:** A cut-out is created on the enclosure's side according to the cable entry's dimensions (see expert's tip 1 - page 279).



Spotlight On...

FL13 and FL21 are standard cut-out dimensions frequently used in northern European countries and also used by our enclosures for several years now.

Key features when selecting a cable entry (3/4)



Full flexibility

5 Flexibility of the installation

- **Full flexibility:** This means that cables can be added/removed easily, changing:
 - quantity
 - diameter
 - position
 (see expert's tip 2, page 279)
- **Medium flexibility:**
 - The amount, diameter or position of cables can be changed to a limited extent.
- **Low flexibility:**
 - It is not possible to change the above parameters.



Medium flexibility

6 Reversibility

- **Full reversibility:** This means that cables can be added/ removed easily without losing their initial characteristics, such as water tightness.
- **Medium reversibility:** For soft membranes, once the cable has been removed, there may be a loss of IP degree depending on the size of the cable and the cut. For hard-plastic entries or combined material entries, initial characteristics are regained by adding plugs.
- **Low reversibility:** The cable entry must be completely replaced in order to regain the initial characteristics.

7 Degree of protection (IP)

- If an enclosure is to be used in a clean, dry and well insulated environment, lower levels of IP may be acceptable (IP54 or IP55).
- In a dusty environment, a higher IP level such as IP65 or IP68 may be required (see expert's tip 4, page 279).

8 Cable retention

- Choose the right level of cable retention according to your needs. For locations accessible to the public, preferably choose a high level of cable retention.

9 Cable diameter

- Choose the cable entry seal according to the cable diameter. Take into account cable diameter tolerances.

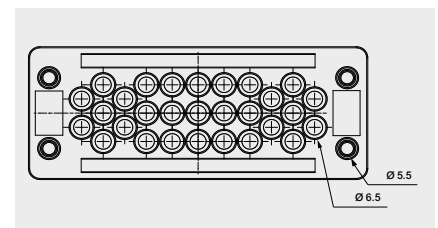
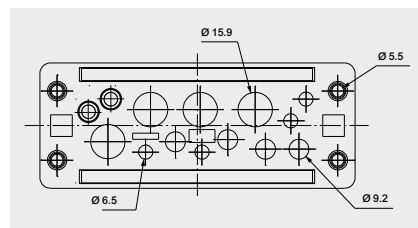

10 Cable installation time

- Each cable entry has different installation characteristics. Some can be installed easily and quickly thanks to the soft membrane. Take this into account depending on labour costs in your region.

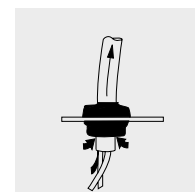
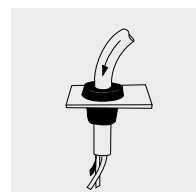
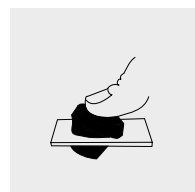

Key features when selecting a cable entry (4/4)



11 Number of cables for a given surface

- For some installations, a large quantity of cables must go through the cable entry. Some cable entries can handle a high density of cables, which can result in a more economical installation (fewer cable entries to be purchased). For small enclosures, it may simply be impossible to install too many cable entries due to the available space on the enclosure's wall (see expert's tip 3, page 279).



12 Cable entries for cables with connectors

- Some cables have large connectors which cannot be pushed through tight cable clamps or cable seals. These cable entries have the unique advantage of not requiring the cable to be cut, thanks to the snap-fitting system.

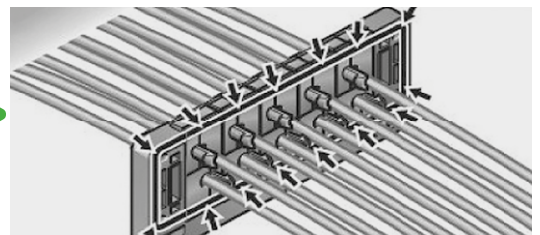
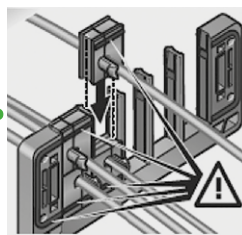
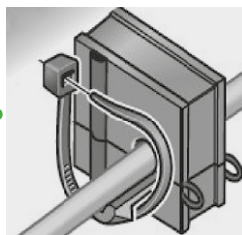
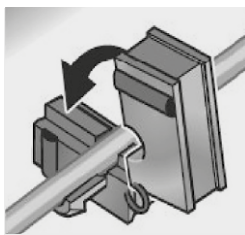

A high cable retention force is provided thanks to the integrated cable fastener

Expert's tip



Specific



Configured



- Some cable entries require cut-outs to be machined on the enclosure or cable gland plate.

- Installing a cable entry with full flexibility is the solution when a large number of enclosures is being prepared for different types of installations. By using one combination of enclosure cable entries, you can cover a large variety of installations!

- When the cable entry has been defined, the next step is cable management inside the enclosure. For correct thermal management, all cables must be fitted and attached so as not to create an obstacle for correct air flow. Consult our Universal Enclosures catalog for cable management accessories (such as cable ducts) and consumables (such as cable ties).

- If your environment requires a high IP level for your installation, make sure you have an appropriate thermal management system to avoid condensation or overheating problems. Consult our Thermal Management offer in our Universal Enclosures catalog and our Control Panel Technical Guide related to this issue.

Multi-A



NSYAECPFLA7



NSYAECPFLA10



NSYAECPFLA25



NSYAECPFLA33



Note:
Details see [page 272](#)

Characteristics	Height mm (in.)	Width mm (in.)	Depth mm (in.)	Diameter of the cable entry (Ø mm (in.))							References	
				No.	13	14	15	16	18	21		30
Multi-A Type FL13	20 (0.79)	135 (5.32)	47 (1.85)	7 (0.28)	-	-	4 (0.16)	-	-	3 (0.12)	-	NSYAECPFLA7
Multi-A Type FL13	20 (0.79)	135 (5.32)	47 (1.85)	10 (0.39)	6 (0.24)	-	-	4 (0.16)	-	-	-	NSYAECPFLA10
Multi-A Type FL21	25 (0.98)	215 (8.46)	86 (3.39)	25 (0.98)	-	16 (0.63)	-	-	6 (0.24)	-	3 (0.12)	NSYAECPFLA25
Multi-A Type FL21	25 (0.98)	215 (8.46)	86 (3.39)	33 (1.30)	-	24 (0.94)	-	-	9 (0.35)	-	-	NSYAECPFLA33

Multi-C



NSYTSAM508SE

Position of the holes on the circular cable entries with diameters 50 and 63 mm:



NSYTSAM504SE NSYTSAM508SE NSYTSAM638SE NSYTSAM6313SE

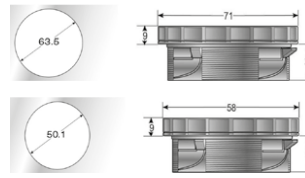

Note:
Details see [page 272](#)

Supply:
10 units.
Reference by unit.
Order by multiples of 10 (10, 20, 30...)

Characteristics	Cut-out Ø mm (in.)	Diameter of the cable entry (Ø mm (in.))							References
		No.	3-5.5	3-6.5	3.6-6.5	5-9.2	6-10	9.6-15.9	
Multi-C	50.5 (1.99)	4	-	-	-	-	3 (0.12)	1 (0.04)	NSYTSAM504SE
Multi-C	50.5 (1.99)	8	-	-	7 (0.28)	-	1 (0.04)	-	NSYTSAM508SE
Multi-C	63.5 (2.50)	8	-	2 (0.08)	-	4 (0.16)	-	2 (0.08)	NSYTSAM638SE
Multi-C	63.5 (2.50)	13	6 (0.24)	-	6 (0.24)	-	1 (0.04)	-	NSYTSAM6313SE

Multi-R

- Material: Polyamide
- Cable entry material: Soft membrane
- Cable glands to be fitted: No
- Installation options: On cable gland plate with special cut-out or directly on enclosure
- Flexibility of the installation: Medium
- Reversibility: Full
- Ingress protection rating: IP55 according to IEC 60529
- Cable retention: Medium
- Cable diameter mm (in.): From 4.3 (0.17) to 15.9 (0.63) mm (in.)
- Cable Installation time: Fast
- Quantity of cables to be fitted for a given surface: ++
- Cable entries for cables with connectors: No

- Cut-out dimensions mm (in.): 112 (4.41) x 36 (1.42) mm (in.)
- External dimensions mm (in.): 146 (5.75) x 14 (0.55) x 58 (2.28) mm (in.)
- Certificates: UL 94 V-0
- Flame resistance: 650°C (1202°F)

Note:
Dimensions and positions of the holes on a rectangular cable entry see [page 314](#)
Details see [page 272](#)

Supply:
1 unit

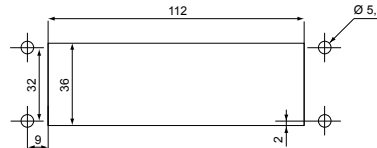

NSYSA2414SE

Characteristics	Cut-out Ø mm (in.)	No.	Diameter of the cable entry (Ø mm (in.))					References
			4.3-8.1	3-6.5	5-9.2	8-12.5	9.6-15.9	
Multi-R	112 (4.41) x 36 (1.42)	14	-	6 (0.24)	4 (0.16)	-	-	NSYSA2414SE
Multi-R	112 (4.41) x 36 (1.42)	17	-	-	17 (0.67)	-	-	NSYSA2417SE
Multi-R	112 (4.41) x 36 (1.42)	22	-	16 (0.63)	4 (0.16)	2 (0.08)	-	NSYSA2422SE
Multi-R	112 (4.41) x 36 (1.42)	23	23 (0.91)	-	-	-	-	NSYSA2423SE
Multi-R	112 (4.41) x 36 (1.42)	29	-	29 (1.14)	-	-	-	NSYSA2429SE

Multi-T

- Type FL21

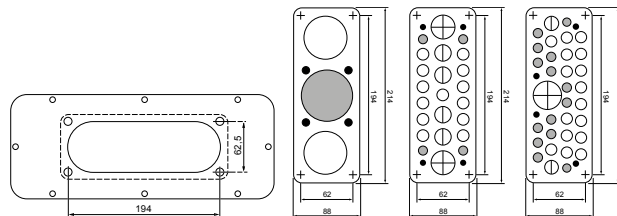

Note:
Details see [page 272](#)



NSYAECFLT25

Characteristics	Diameter of the cable entry (Ø mm (in.))											References	
	No.	5-7	6-10	8-12	8-16	10-14	12-18	14-20	17-32	20-26	24-54		30-60
Multi-T, metal plate	0	-	-	-	-	-	-	-	-	-	-	-	NSYAECFLBP
Multi-T	7	-	-	-	4 (0.16)	-	-	-	-	-	2 (0.08)	1	NSYAECFLT7
Multi-T	27	4 (0.16)	-	4 (0.16)	-	13 (0.51)	-	4 (0.16)	-	2 (0.08)	-	-	NSYAECFLT25
Multi-T	37	-	4 (0.16)	14 (0.55)	-	16 (0.63)	2 (0.08)	-	1 (0.04)	-	-	-	NSYAECFLT35

Multi-H

- Type FL21

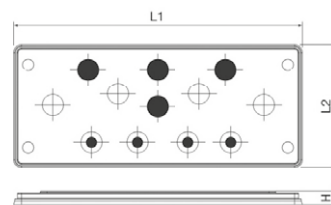

Note:
Details see [page 273](#)



NSYSAKFL

Characteristics	L1	L2	H	Diameter of the cable entry (Ø mm (in.))			References
	mm (in.)	mm (in.)	mm (in.)	M12	M12 or M20	M16 or M25	
Multi-H	10 (0.39)	215 (8.46)	85 (3.35)	4 (0.16)	4 (0.16)	4 (0.16)	NSYSAKFL

Multi-F

- Type FL13 or FL21
- Diameter of the cable entry 4 (0.16) - 10 (0.39) mm (in.): "Pop-out" membranes only
- Diameter of the cable entry M16, M20 or M25: "Pop-out" membranes or cable gland installation
- Diameter of the cable entry M32, M40 or M50: Knock-out system

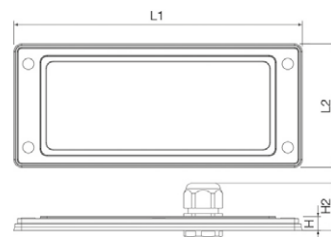

Note:
Details see [page 273](#)



NSYAECPKFL11

Characteristics	Dimensions mm (in.)				Diameter of the cable entry (Ø mm (in.))					References
	L1	L2	H	H2	4-10	M16 (5-10)	M20 (6-13)	M25 (8-17)	M32, M40 or M50	
MMulti-F FL13	134 (5.28)	52 (2.05)	6.5 (0.26)	~ 35	10 (0.39)	-	1 (0.04)	-	-	NSYAECPKFL11
Multi-F	214 (8.42)	90 (3.54)	9 (0.35)	~ 35	-	2 (0.08)	2 (0.08)	2 (0.08)	1 (0.04)	NSYAECPKFL7A
Multi-F	214 (8.42)	90 (3.54)	9 (0.35)	~ 35	-	4 (0.16)	2 (0.08)	4 (0.16)	-	NSYAECPKFL10

Technical changes reserved. Information provided without guarantee. Images are for illustrative purposes only.

Multi-CR

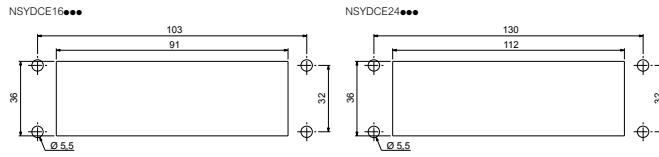

Note:
Details see [page 273](#)

Supply:
1 molded part and fixing elements

Characteristics	Connector cut-out type	Number of cable entries	References
Multi-CR	16	8	NSYDCE168
Multi-CR	24	4	NSYDCE244
Multi-CR	24	10	NSYDCE2410

Split seals for cable entries equipped with connectors

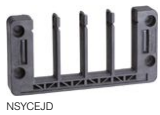

- Split seals suited to the diameter of the cable to be mounted on the cable entry molded parts for the connectors. Ref. **NSYDCE●●●**

Supply:
10 units. Reference per unit. To be ordered in multiples of 10 (10, 20, 30, etc.).

Characteristics	For cables Ø mm (in.)	References
Split seals for cable entries equipped with connectors	0 (0.00)	NSYCEJD
Split seals for cable entries equipped with connectors	3 (0.12)-4 (0.16)	NSYCEJD3
Split seals for cable entries equipped with connectors	5 (0.20)-6 (0.24)	NSYCEJD5
Split seals for cable entries equipped with connectors	7 (0.28)-8 (0.32)	NSYCEJD7
Split seals for cable entries equipped with connectors	9 (0.35)-10 (0.39)	NSYCEJD9
Split seals for cable entries equipped with connectors	11 (0.43)-12 (0.47)	NSYCEJD11
Split seals for cable entries equipped with connectors	13 (0.51)-14 (0.55)	NSYCEJD13
Split seals for cable entries equipped with connectors, large seal, 24/4 die only	16 (0.63)-17 (0.67)	NSYCEJD16
Split seals for cable entries equipped with connectors, large seal, 24/4 die only	18 (0.71)-19 (0.75)	NSYCEJD18
Split seals for cable entries equipped with connectors, large seal, 24/4 die only	20 (0.79)-21 (0.83)	NSYCEJD20
Split seals for cable entries equipped with connectors, large seal, 24/4 die only	22 (0.87)-23 (0.91)	NSYCEJD22
Split seals for cable entries equipped with connectors, large seal, 24/4 die only	24 (0.94)-25 (0.98)	NSYCEJD24
Split seals for cable entries equipped with connectors, large seal, 24/4 die only	26 (1.02)-27 (1.06)	NSYCEJD26
Split seals for cable entries equipped with connectors, large seal, 24/4 die only	28 (1.10)-29 (1.14)	NSYCEJD28
Split seals for cable entries equipped with connectors, large seal, 24/4 die only	30 (1.18)-31 (1.22)	NSYCEJD30

Multi-CS

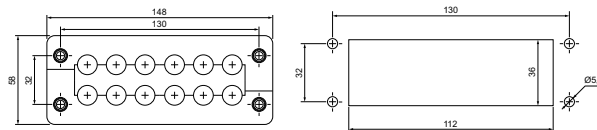

Note:
Details see [page 272](#)

Supply:
1 unit

Characteristics	Cut-out mm (in.)	Diameter of the cable entry (Ø mm (in.))			References
		No.	2-12	12-24	
Multi-CS	112 (4.41) x 36 (1.42)	12 (0.47)	12 (0.47)	-	NSYDCC2412
Multi-CS	112 (4.41) x 36 (1.42)	4 (0.16)	-	4 (0.16)	NSYDCC244
Multi-CS	112 (4.41) x 36 (1.42)	8 (0.32)	6 (0.24)	2 (0.08)	NSYDCC248
Multi-CS	112 (4.41) x 36 (1.42)	9 (0.35)	8 (0.32)	1 (0.04)	NSYDCC249

Cable gland



NSYCEJDS2

Supply:
Small cable gland: Pack of 12
Large cable gland: Pack of 4

Characteristics	Cable Ø mm (in.)	References
Cable gland, small	2 (0.08) - 3 (0.12)	NSYCEJDS2
Cable gland, small	3 (0.12) - 4 (0.16)	NSYCEJDS3
Cable gland, small	4 (0.16) - 5 (0.20)	NSYCEJDS4
Cable gland, small	5 (0.20) - 6 (0.24)	NSYCEJDS5
Cable gland, small	6 (0.24) - 7 (0.28)	NSYCEJDS6
Cable gland, small	7 (0.28) - 8 (0.32)	NSYCEJDS7
Cable gland, small	8 (0.32) - 9 (0.35)	NSYCEJDS8
Cable gland, small	9 (0.35) - 10 (0.39)	NSYCEJDS9
Cable gland, small	10 (0.39) - 11 (0.43)	NSYCEJDS10
Cable gland, small	11 (0.43) - 12 (0.47)	NSYCEJDS11
Cable gland, large	-	-
Cable gland, large	12 (0.47) - 13 (0.51)	NSYCEJDL12
Cable gland, large	13 (0.51) - 14 (0.55)	NSYCEJDL13
Cable gland, large	14 (0.55) - 15 (0.59)	NSYCEJDL14
Cable gland, large	15 (0.59) - 16 (0.63)	NSYCEJDL15
Cable gland, large	16 (0.63) - 17 (0.67)	NSYCEJDL16
Cable gland, large	17 (0.67) - 18 (0.71)	NSYCEJDL17
Cable gland, large	18 (0.71) - 19 (0.75)	NSYCEJDL18
Cable gland, large	19 (0.75) - 20 (0.79)	NSYCEJDL19
Cable gland, large	20 (0.79) - 21 (0.83)	NSYCEJDL20
Cable gland, large	21 (0.83) - 22 (0.87)	NSYCEJDL21

Blanking plugs



NSYCEJDS0

Supply:
Small blanking plugs: Pack of 12
Large blanking plugs: Pack of 4

Characteristics	References
Blanking plugs, small	NSYCEJDS0
Blanking plugs, large	NSYCEJDL0

Multi-CF

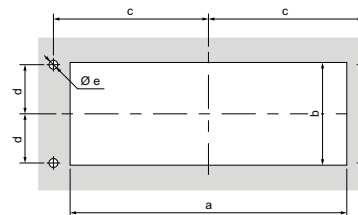

Note:
Details see [page 273](#)

Supply:
1 unit



NSYTLK2414



NSYTLK2422

Characteristics	Diameter of the cable entry (Ø mm (in.))							References
	No.	No. x Ø max.	a	b	c	d	e	
Multi-CF	14	6 x 9 (0.35) 4 x 11 (0.43) 4 x 18 (0.71)	112 (4.41)	36 (1.42)	65 (2.56)	16 (0.63)	5.5 (0.22)	NSYTLK2414
Multi-CF	22	16 x 9 (0.35) 4 x 11 (0.43) 2 x 15 (0.59)	112 (4.41)	36 (1.42)	65 (2.56)	16 (0.63)	5.5 (0.22)	NSYTLK2422
Multi-CF	28	28 x 9 (0.35)	112 (4.41)	36 (1.42)	65 (2.56)	16 (0.63)	5.5 (0.22)	NSYTLK2428
Multi-CF	46	46 x 9 (0.35)	112 (4.41)	36 (1.42)	65 (2.56)	16 (0.63)	5.5 (0.22)	NSYTLK2446
Multi-CF	multi	3 / 27 x 300 (11.81)	112 (4.41)	36 (1.42)	65 (2.56)	16 (0.63)	5.5 (0.22)	NSYTLK24M

Cable clamp for improved cable retention for Multi-A

- Installation on FL 21 membrane type "A" for cable entrance to block cables when installed. It can be easily removed.
- Material: PA6
- Temperature range: -40°C (-40°F) to +85°C (+185°F)

Installation:

1. Push the cable through the membrane entrance to the desired position
2. Put the cable clamp around the cable and slide it into the cable entry
3. Push the cable clamp fully into the membrane entrance and the cable will be fixed

Note:

Secure your installation with an easy solution for cable anchorage.



NSYAECPFLACA30

Characteristics	Cable clamp outer Ø mm (in.)	Membrane entrance Ø mm (in.)	Cable Ø range mm (in.)	References
Set of 8 cable clamps for improved cable retention for Multi-A	15 (0.59)	14 (0.55)	7 (0.28)-9 (0.35)	NSYAECPFLACA14
Set of 6 cable clamps for improved cable retention for Multi-A	18 (0.71)	18 (0.71)	9 (0.35)-11 (0.43)	NSYAECPFLACA18
Set of 6 cable clamps for improved cable retention for Multi-A	20 (0.79)	18 (0.71)	10 (0.39)-12 (0.47)	NSYAECPFLACA20
Set of 3 cable clamps for improved cable retention for Multi-A	30 (1.18)	30 (1.18)	20 (0.79)-23 (0.91)	NSYAECPFLACA30

Steel adapter plate for FL13 and FL21 membranes

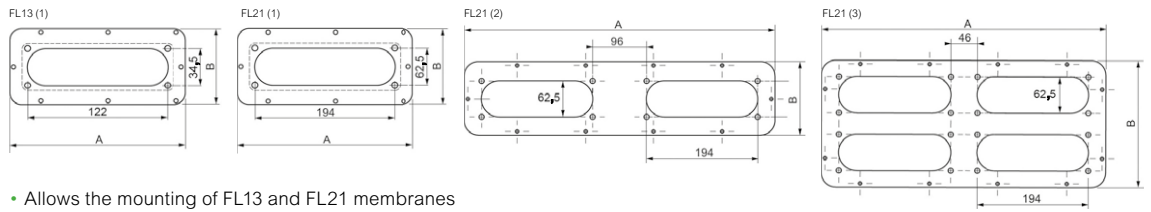

- Allows the mounting of FL13 and FL21 membranes on every type of enclosure.
- Our membrane can be easily adapted to fit onto all our metal enclosures using the adapter plate.
- Ingress protection rating IP55 according to IEC 60529

Supply:
Delivered with fixing screws and gasket



Characteristics	Type	Plate dimensions mm (in.)		Cut-out dimensions mm (in.)		References
		A	B	H	I	
Steel adapter plate for FL13 membranes (1)	B	245 (9.65)	80 (3.15)	212 (8.35)	47 (1.85)	NSYTLBFL
Steel adapter plate for FL21 membranes (1)	C	245 (9.65)	130 (5.12)	212 (8.35)	97 (3.82)	NSYTLCLFL
Steel adapter plate for FL21 membranes (1)	D	345 (13.58)	130 (5.12)	312 (12.28)	97 (3.82)	NSYTLDFL
Steel adapter plate for FL21 membranes (1)	E	445 (17.52)	130 (5.12)	412 (16.22)	97 (3.82)	NSYTLLEFL
Steel adapter plate for FL21 membranes (1)	F	545 (21.46)	130 (5.12)	512 (20.16)	97 (3.82)	NSYTLFFL
Steel adapter plate for FL21 membranes (2)	F	545 (21.46)	130 (5.12)	512 (20.16)	97 (3.82)	NSYTLF2FL
Steel adapter plate for FL21 membranes (1)	G	495 (19.49)	220 (8.66)	462 (18.19)	187 (7.36)	NSYTLGFL
Steel adapter plate for FL21 membranes (2)	G	495 (19.49)	220 (8.66)	462 (18.19)	187 (7.36)	NSYTLG2FL
Steel adapter plate for FL21 membranes (3)	G	495 (19.49)	220 (8.66)	462 (18.19)	187 (7.36)	NSYTLG4FL

Mixed membrane entries for IP55 direct cable entries

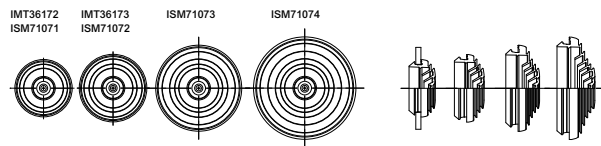

Note:
Details see [page 274](#)

Supply:
Minimal packaging of 10 pieces



Characteristics	Drill hole Ø mm (in.)	Cable / conduit Ø mm (in.)	References
Mixed membrane entries for IP55 direct cable entries, RAL 9010	23 (0.91)	4 (0.16) - 20 (0.79)	IMT36172
Mixed membrane entries for IP55 direct cable entries, RAL 9010	29 (1.14)	4 (0.16) - 25 (0.98)	IMT36173
Mixed membrane entries for IP55 direct cable entries, RAL 7035	23 (0.91)	4 (0.16) - 20 (0.79)	ISM71071
Mixed membrane entries for IP55 direct cable entries, RAL 7035	29 (1.14)	4 (0.16) - 25 (0.98)	ISM71072
Mixed membrane entries for IP55 direct cable entries, RAL 7035	36 (1.42)	4 (0.16) - 32 (1.26)	ISM71073
Mixed membrane entries for IP55 direct cable entries, RAL 7035	44 (1.73)	4 (0.16) - 40 (1.58)	ISM71074

PVC adjustable cone-shaped entries

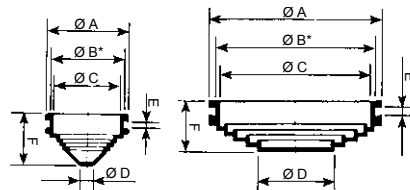

Note:
* Drill-hole for mounting.
Details see [page 274](#)

Supply:
NSYECPC3 50 cable entries,
NSYECPC5 and NSYECPC6
each 25 cable entries,
NSYECPC9 and NSYECPC15
each 10 cable entries



Characteristics	Dimensions mm (in.)						Capacity		References
	Ø A	Ø B*	Ø C	Ø D	E	F	Cable (Ø mm (in.))	Tube	
PVC adjustable cone-shaped entries	25 (0.98)	21.5 (0.85)	18 (0.71)	5 (0.20)	3.2 (0.13)	13 (0.51)	5 (0.20)-18 (0.71)	PG 9-11	NSYECPC3
PVC adjustable cone-shaped entries	33 (1.30)	29.5 (1.16)	26 (1.02)	5 (0.20)	3.2 (0.13)	20 (0.79)	5 (0.20)-26 (1.02)	PG 9-16	NSYECPC5
PVC adjustable cone-shaped entries	43 (1.69)	38.5 (1.52)	36 (1.42)	5 (0.20)	3.2 (0.13)	22 (0.87)	5 (0.20)-36 (1.42)	PG 9-21	NSYECPC6
PVC adjustable cone-shaped entries	70 (2.76)	63 (2.48)	60 (2.36)	28 (1.10)	3 (0.12)	20 (0.79)	28 (1.10)-60 (2.36)	PG 21-48	NSYECPC9
PVC adjustable cone-shaped entries	98 (3.86)	90 (3.54)	87 (3.42)	28 (1.10)	3 (0.12)	23 (0.91)	28 (1.10)-87 (3.42)	PG 21-48	NSYECPC15

ISO cable gland



ISM71503

- The cable gland (ref. **IMT36150**) is especially recommended for security circuits.

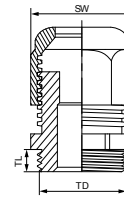

Note:
* In brackets: Tolerance.
Details see [page 274](#)

Supply:
The cable glands are supplied with nuts. Pack of 20 (M12 to M20), 10 (M25 and M32), 5 (M40)

Characteristics	Dimensions						References
	ISO	Cable Ø mm (in.)	Drill hole* Ø mm (in.)	TD	TL		
Cable gland	M12	3 (0.12) / 6.5 (0.26)	12.2 (0.48) (0 + 0.2)	12 (0.47)	6 (0.24)	15 (0.59)	ISM71501
Cable gland	M16	4 (0.16) / 8 (0.32)	16.2 (0.64) (0 + 0.2)	16 (0.63)	8 (0.32)	19 (0.75)	ISM71502
Cable gland	M20	6 (0.24) / 12 (0.47)	20.2 (0.80) (0 + 0.2)	20 (0.79)	10 (0.39)	24 (0.94)	ISM71503
Cable gland with high resistance to fire	M20	6 (0.24) / 12 (0.47)	20.2 (0.80) (0 + 0.2)	20 (0.79)	10 (0.39)	24 (0.94)	IMT36150
Cable gland	M25	11 (0.43) / 17 (0.67)	25.2 (0.99) (0 + 0.2)	25 (0.98)	8 (0.32)	29 (1.14)	ISM71504
Cable gland	M32	15 (0.59) / 21 (0.83)	32.2 (1.27) (0 + 0.3)	32 (1.26)	10 (0.39)	36 (1.42)	ISM71505
Cable gland	M40	19 (0.75) / 28 (1.10)	40.5 (1.59) (0 + 0.3)	40 (1.58)	10 (0.39)	46 (1.81)	ISM71506

Quick cable entries



IMT36179

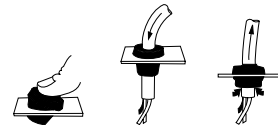

Note:
Details see [page 274](#)

Supply:
50 (M12 to M32), 25 (M40 and M50)

Characteristics	Dimensions			References
	Ø	Drill hole Ø mm (in.)	Cable Ø mm (in.)	
Quick cable entries	M12	12.5 (0.49)	3 (0.12) - 5 (0.20)	IMT36179
Quick cable entries	M16	16 (0.63)	5 (0.20) - 7 (0.28)	IMT36180
Quick cable entries	M20	20.3 (0.80)	7 (0.28) - 10 (0.39)	IMT36181
Quick cable entries	M25	25.3 (1.00)	10 (0.39) - 14 (0.55)	IMT36182
Quick cable entries	M32	32.4 (1.28)	14 (0.55) - 20 (0.79)	IMT36183
Quick cable entries	M40	40.7 (1.60)	20 (0.79) - 26 (1.02)	IMT36184
Quick cable entries	M50	50.7 (2.00)	26 (1.02) - 35 (1.38)	IMT36185

PVC adjustable cone-shaped entries



NSYEC7

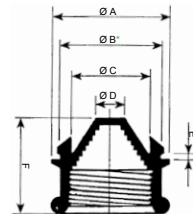

Note:
Details see [page 274](#)

Supply:
25 cable entries

Characteristics	Dimensions mm (in.)						Capacity		References
	Ø A	Ø B	Ø C	Ø D	E	F	Cable Ø mm (in.)	Tube	
PVC adjustable cone-shaped entries	52 (2.05)	48.5 (1.91)	44 (1.73)	13 (0.51)	1.5 (0.06)	30 (1.18)	13 (0.51) to 44 (1.73)	PG 36	NSYEC7

Synthetic snap-in cable gland



NSYCGSP16

- Wall thickness : E = 0.5 (0.02) to 4 (0.16) mm (in.).

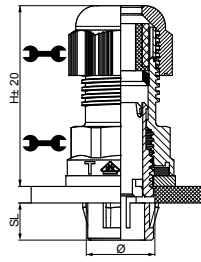

Note:
Details see [page 274](#)

Supply:
The cable glands are supplied with nuts. Pack of 20 (M16 and M20), of 10 (M25 and M32), of 5 (M40)

Characteristics	Dimensions							References
	Ø	Ø min / max	Drill Ø	SL	SD	H		
Synthetic snap-in cable gland	M16	5 (0.20)/10 (0.39)	16.2 to 16.4	9 (0.35)	15.9 (0.63)	42.5 (1.67)	22 (0.87)	NSYCGSP16
Synthetic snap-in cable gland	M20	6 (0.24)/12 (0.47)	20.2 to 20.4	9 (0.35)	19.9 (0.78)	41.5 (1.63)	24 (0.94)	NSYCGSP20
Synthetic snap-in cable gland	M25	11 (0.43)/17 (0.67)	25.2 to 25.4	9 (0.35)	24.9 (0.98)	43.5 (1.71)	29 (1.14)	NSYCGSP25
Synthetic snap-in cable gland	M32	15 (0.59)/21 (0.83)	32.2 to 32.4	9 (0.35)	31.9 (1.26)	49.5 (1.95)	36 (1.42)	NSYCGSP32
Synthetic snap-in cable gland	M40	19 (0.75)/28 (1.10)	40.2 to 40.4	11.5 (0.45)	39.9 (1.57)	56 (2.20)	46 (1.81)	NSYCGSP40

Snap-in cable gland disassembling tool

- Tool to quickly disassemble cable gland.
- Material: Plastic



NSYDT16



NSYDT20

Note:
Details see [page 274](#)

Characteristics	Ø	References
Snap-in cable gland disassembling tool	M16	NSYDT16
Snap-in cable gland disassembling tool	M20	NSYDT20
Snap-in cable gland disassembling tool	M25	NSYDT25
Snap-in cable gland disassembling tool	M32	NSYDT32
Snap-in cable gland disassembling tool	M40	NSYDT40

Stainless-steel cable gland with lamellar insert

- Lamellar technology provides excellent resistance to traction as well as excellent torsional protection. For aggressive environments.
- Material: Stainless-steel AISI 304L or AISI 316L, neoprene gasket
- Cable entry material: Non armoured
- Installation options:
 - On cable gland plate or directly on enclosure
- Flexibility of the installation: Low
- Reversibility: Medium
- Ingress protection rating: IP68
- Cable retention: High
- Cable diameter mm (in.): From 12 (0.47) to 40 (1.58)
- Cable Installation time: Slow
- Quantity of cables to be fitted for a given surface: +
- Cable entries for cables with connectors: No
- Thread type: Metric EN 60423
- Cut-out dimensions mm (in.):
 - Various circular hole diameters according to cable diameter
- External dimensions mm (in.): From Ø 14 (0.55) to 43 (1.69)
- Certificates: UL 94 V-2
- Standard: DIN EN 62444, UL 514
- Temperature range: -20°C (-4°F) to + 100°C (212°F)

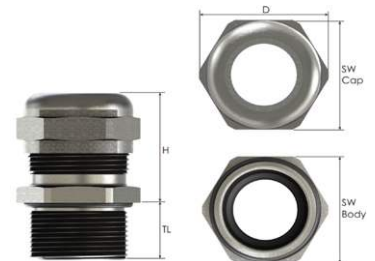

Supply:
The cable glands are supplied with nuts. Pack of 5 (M12 and M16), of 4 (M20 and M25), of 2 (M32 and M40)



NSYCGX12

Characteristics	Dimensions							References
	Ø	Ø min-max mm (in.)	Thread Length TL mm (in.)	SW Cap mm (in.)	SW Body mm (in.)	Outer Ø D mm (in.)	max. Height H mm (in.)	
AISI 304L	M12x1.5	3.0 (0.12) - 6.5 (0.26)	6 (0.24)	14 (0.55)	14 (0.55)	15.5 (0.61)	24 (0.94)	NSYCGX12
AISI 304L	M16x1.5	4.0 (0.16) - 8.0 (0.32)	7 (0.28)	17 (0.67)	19 (0.75)	21 (0.83)	25.5 (10.04)	NSYCGX16
AISI 304L	M20x1.5	10.0 (0.39) - 14.0 (0.55)	8 (0.32)	24 (0.94)	24 (0.94)	26.5 (10.43)	30 (1.18)	NSYCGX20
AISI 304L	M25x1.5	10.0 (0.39) - 14.0 (0.55)	8 (0.32)	24 (0.94)	27 (1.06)	30 (1.18)	30 (1.18)	NSYCGX25
AISI 304L	M32x1.5	13.0 (0.51) - 18.0 (0.71)	9 (0.35)	30 (1.18)	36 (1.42)	39.8 (15.67)	35 (1.38)	NSYCGX32
AISI 304L	M40x1.5	18.0 (0.71) - 25.0 (0.98)	9 (0.35)	41 (1.61)	46 (1.81)	51.4 (20.24)	40.5 (15.95)	NSYCGX40
AISI 316L	M12x1.5	3.0 (0.12) - 6.5 (0.26)	6 (0.24)	14 (0.55)	14 (0.55)	15.5 (0.61)	24 (0.94)	NSYCGX12H
AISI 316L	M16x1.5	4.0 (0.16) - 8.0 (0.32)	7 (0.28)	17 (0.67)	19 (0.75)	21 (0.83)	25.5 (10.04)	NSYCGX16H
AISI 316L	M20x1.5	10.0 (0.39) - 14.0 (0.55)	8 (0.32)	24 (0.94)	24 (0.94)	26.5 (10.43)	30 (1.18)	NSYCGX20H
AISI 316L	M25x1.5	10.0 (0.39) - 14.0 (0.55)	8 (0.32)	24 (0.94)	27 (1.06)	30 (1.18)	30 (1.18)	NSYCGX25H
AISI 316L	M32x1.5	13.0 (0.51) - 18.0 (0.71)	9 (0.35)	30 (1.18)	36 (1.42)	39.8 (15.67)	35 (1.38)	NSYCGX32H
AISI 316L	M40x1.5	18.0 (0.71) - 25.0 (0.98)	9 (0.35)	41 (1.61)	46 (1.81)	51.4 (20.24)	40.5 (15.95)	NSYCGX40H

Technical changes reserved. Information provided without guarantee. Images are for illustrative purposes only.

SM SMX SF SFX Lower cable-guide cross-rail

- It allows the quick-fixing of cables entering and exiting the enclosure.
- Depth adjustable every 25 (0.98) mm (in.).
- Material: Galvanized steel

Fixing:

- Spacial SF: for suitable enclosures with widths of 1200 (47.24) and 1600 (62.99) mm (in.), use the adaptation kit for double-door suitable enclosures, see [page 250](#)
- Spacial SM: for floor-standing enclosures with a width of 1200 (47.24) mm (in.), a top/bottom mounting rail installed in central position is required
- Spacial SFX: no adaptation piece is required for the 1200 (47.24) mm (in.) suitable enclosures
- Spacial SMX: no adaptation piece is required for the 1600 (62.99) mm (in.) floor-standing enclosures



NSYCFP60

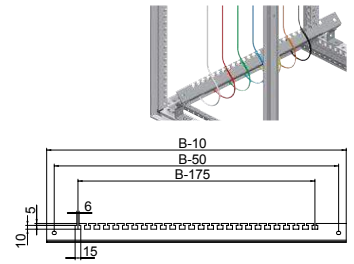

Supply:

1 cable-guide cross-rail and fixing elements

Characteristics	Width mm (in.)	References
Lower cable-guide cross-rail	600 (23.62)	NSYCFP60
Lower cable-guide cross-rail	800 (31.50)	NSYCFP80
Lower cable-guide cross-rail	1000 (39.37)	NSYCFP100
Lower cable-guide cross-rail	1200 (47.24)	2x NSYCFP60
Lower cable-guide cross-rail	1600 (62.99)	2x NSYCFP80

SM SMX SF SFX Cable-guide cross-rails for framework

Support types:

- Angle support at 90°: For vertical cable fixing.
- Angle support at 120°: For fixing cables near the cable entry.
- Material: Zinc-coated steel

Fixing:

- Spacial SF/SFX: support for direct mounting on the framework, cross-rails or rails
- Spacial SM: fixing on the bottom mounting rail, or on the floor-standing enclosure by means of adaptation rails and 40 (1.58) mm (in.) universal cross-rails (1 row) in vertical position
- Spacial SMX: fixing on the bottom mounting rail and 40 (1.58) mm (in.) universal cross-rails (1 row) in vertical position



NSYCF96

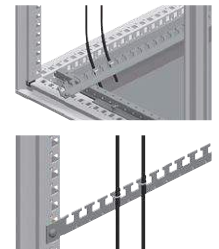

Supply:

2 supports and fixing elements

Characteristics	Support angle	Width mm (in.)	References
Cable-guide cross-rails for framework	90°	600 (23.62)	NSYCF96
Cable-guide cross-rails for framework	120°	600 (23.62)	NSYCF126
Cable-guide cross-rails for framework	90°	800 (31.50)	NSYCF98
Cable-guide cross-rails for framework	120°	800 (31.50)	NSYCF128

SM SMX SF SFX L-rail for fixing cables

- Rail for fixing cables entering from the bottom.
- Adjustable depth with a pitch of 25 (0.98) mm (in.).
- It is not possible to mount it on a plinth cross-rail.
- Material: Zinc-coated steel

Fixing:

- Spacial SF/SFX: fixing to the bottom frame, above the cable entry, or else to the plinth, using the plinth cross-rails, see [page 110](#)
- Spacial SM/SMX: fixing to the bottom adjustment rails, above the cable entry, or else to the plinth, using the plinth cross-rails, see [page 110](#)
- The cables are fixed to the rail by means of metal clamps



NSYFCG60

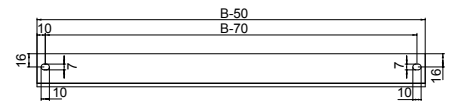
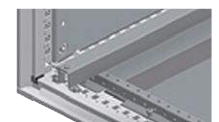

Supply:

One rail, two mounting supports and fixing elements

Characteristics	Width mm (in.)	References
L-rail for fixing cables	600 (23.62)	NSYFCG60
L-rail for fixing cables	800 (31.50)	NSYFCG80
L-rail for fixing cables	1000 (39.37)	NSYFCG100
L-rail for fixing cables	1200 (47.24)	NSYFCG120
L-rail for fixing cables	1600 (62.99)	NSYFCG160

SM SMX SF SFX Door cable-guide cross-rail

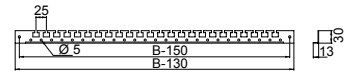

- Recommended for fixing cables in the internal equipment of the door.
- Height adjustable every 25 (0.98) mm (in.).
- Material: Zinc-coated steel
- Fixing: Direct fixing on the reinforcement frame

Supply:
2 cable-guide cross-rails and fixing elements



NSYSDGCR5

Characteristics	Width mm (in.)	References
Door cable-guide cross-rail	600 (23.62)	NSYSDGCR5
Door cable-guide cross-rail	600 (23.62)	NSYSDGCR6
Door cable-guide cross-rail	800 (31.50)	NSYSDGCR8
Door cable-guide cross-rail	1000 (39.37)	NSYSDGCR10

Plastic cable support

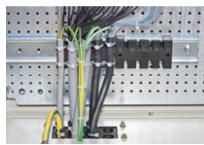
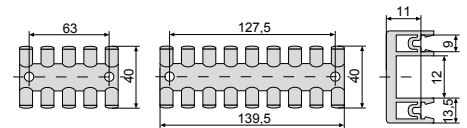

NSYSCCDINLG75

- It clips or screws onto 35 (1.38) mm (in.) symmetric rails or a C-shaped rail. Fixing: Quick and easy fixing of cables using cable ties

Supply:
10 units. Reference by unit. Order by multiples of 10 (10, 20, 30...)

Characteristics	Max. no. of cables	Width mm (in.)	References
Plastic cable support	5	75 (2.95)	NSYSCCDINLG75
Plastic cable support	9	140 (5.51)	NSYSCCDINLG140

CRN S3D S3X Door cable-guide cross-rails for wall-mounted enclosures

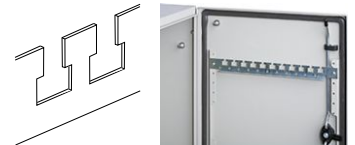

- They are installed on wall-mounted enclosures with heights from 400 (15.75) mm (in.) for Spacial S3D and 500 (19.68) mm (in.) for Spacial S3X.
- They make it easy to equip the inside of the door.
- Installation cable ties, see [page 313](#).
- Fixing: They are fixed to the door reinforcement frame by 2 self-tapping screws. The angle can be directed towards the body of the enclosure or towards the door

Supply:
2 cable-guide cross-rails and fixing elements



NSYTFPCR4

Characteristics	Width mm (in.)	References
Door cable-guide cross-rails for wall-mounted enclosures	400 (15.75)	NSYTFPCR4
Door cable-guide cross-rails for wall-mounted enclosures	500 (19.68)	NSYTFPCR5
Door cable-guide cross-rails for wall-mounted enclosures	600 (23.62)	NSYTFPCR6
Door cable-guide cross-rails for wall-mounted enclosures	800 (31.50)	NSYTFPCR8
Door cable-guide cross-rails for wall-mounted enclosures	1000 (39.37)	NSYTFPCR10

Thorsman cable ties

Description

- Cable ties are used for a wide range of applications including bundle up and fix cables, conduits and tubing
- Material: PA6.6
- Available in black and clear color
- Max operating temperature -40°C (-40°F) to +85°C (185°F)
- Minimum installation temperature -20°C (-4°F)

Application

- There are two types of Thorsman cable ties available: made of clear polyamide, for indoor use
- made of UV-stabilized black polyamide for both indoor and outdoor use

Benefits

- The cable ties are self-locking. They cannot be opened and re-used.
- The cable ties have smooth rounded edges for easier handling and safer installation.
- The rounded tip allows easier insertion through the head of the cable tie.
- User-friendly re-sealable packaging and documented quality.
- Manufactured and tested to EN62275, RoHS compliant.



IMT46026

Characteristics	Type mm (in.)	Length mm (in.)	Color	Qty per package	References
Thorsman cable ties	2.5 (0.10)	100 (3.94)	Clear	100	IMT46026
Thorsman cable ties	2.5 (0.10)	100 (3.94)	Black	100	IMT46033
Thorsman cable ties	2.5 (0.10)	120 (4.72)	Clear	100	IMT46035
Thorsman cable ties	2.5 (0.10)	120 (4.72)	Black	100	IMT46036
Thorsman cable ties	2.5 (0.10)	160 (6.30)	Clear	100	IMT46074
Thorsman cable ties	2.5 (0.10)	160 (6.30)	Black	100	IMT46073
Thorsman cable ties	2.5 (0.10)	200 (7.87)	Clear	100	IMT46158
Thorsman cable ties	2.5 (0.10)	200 (7.87)	Black	100	IMT46157
Thorsman cable ties	3.6 (0.14)	150 (5.91)	Clear	100	IMT46064
Thorsman cable ties	3.6 (0.14)	150 (5.91)	Black	100	IMT46071
Thorsman cable ties	3.6 (0.14)	200 (7.87)	Clear	100	IMT46149
Thorsman cable ties	3.6 (0.14)	200 (7.87)	Black	100	IMT46156
Thorsman cable ties	3.6 (0.14)	300 (11.81)	Clear	100	IMT46921
Thorsman cable ties	3.6 (0.14)	300 (11.81)	Black	100	IMT46922
Thorsman cable ties	4.8 (0.19)	200 (7.87)	Clear	100	IMT46101
Thorsman cable ties	4.8 (0.19)	200 (7.87)	Black	100	IMT46118
Thorsman cable ties	4.8 (0.19)	250 (9.84)	Clear	100	IMT46918
Thorsman cable ties	4.8 (0.19)	250 (9.84)	Black	100	IMT46968
Thorsman cable ties	4.8 (0.19)	300 (11.81)	Clear	100	IMT46919
Thorsman cable ties	4.8 (0.19)	300 (11.81)	Black	100	IMT46969
Thorsman cable ties	4.8 (0.19)	370 (14.57)	Clear	100	IMT46248
Thorsman cable ties	4.8 (0.19)	370 (14.57)	Black	100	IMT46970
Thorsman cable ties	7.6 (0.30)	300 (11.81)	Black	100	IMT46923
Thorsman cable ties	7.6 (0.30)	380 (14.96)	Clear	100	IMT46286
Thorsman cable ties	7.6 (0.30)	380 (14.96)	Black	100	IMT46293
Thorsman cable ties	8.8 (0.35)	550 (21.65)	Clear	100	IMT46926
Thorsman cable ties	8.8 (0.35)	550 (21.65)	Black	100	IMT46924
Thorsman cable ties	8.8 (0.35)	780 (30.71)	Black	100	IMT46927
Thorsman cable ties	2.5 (0.10)	100 (3.94)	Black	20	IMT46231
Thorsman cable ties	2.5 (0.10)	100 (3.94)	Clear	20	IMT46221
Thorsman cable ties	4.6 (0.18)	200 (7.87)	Black	20	IMT46232
Thorsman cable ties	4.6 (0.18)	200 (7.87)	Clear	20	IMT46222
Thorsman cable ties	4.8 (0.19)	280 (11.02)	Black	20	IMT46233
Thorsman cable ties	4.8 (0.19)	280 (11.02)	Clear	20	IMT46223
Thorsman cable ties	4.8 (0.19)	380 (14.96)	Clear	20	IMT46224
Thorsman cable ties	4.8 (0.19)	380 (14.96)	Black	20	IMT46234

Thorsman accessories



IMT47000



IMT47002



IMT47004

- Self-adhesive base for fixing of cable ties. Available in two sizes, one for max. tie width 3.6 (0.14) mm (in.) and the other for max. tie width 4.8 (0.19) mm (in.). Both self-adhesive bases use high-end 3M foam. There are additional screw-fix option cradle for fixing cable tie and cable tie with identification and marking tab.
- Material: PA6.6

Characteristics	Type	Dimensions H x W x D mm (in.)	Color	Qty per package	References
Self-adhesive bases	For max. tie width 3.6 (0.14) mm (in.)	19 (0.75)/19 (0.75)/5.8 (0.23)	Clear	100	IMT47000
Self-adhesive bases	For max. tie width 4.8 (0.19) mm (in.)	28 (1.10)/28 (1.10)/6.4 (0.25)	Clear	100	IMT47001
Cradle	For max. tie width 7.8 (0.31) mm (in.)	22 (0.87)/16 (0.63)/9.6 (0.38)	Clear	100	IMT47002
Cable tie with ID tab	Cable tie with ID tab 100 (3.94) x 2.5 (0.10) mm (in.)	100 (3.94)/2.5 (0.10)	Clear	100	IMT47004

Technical changes reserved. Information provided without guarantee. Images are for illustrative purposes only.

Corrugated cable tube

- Corrugated tube allowing cable entry between the structure and the door.
- Free from halogens and heavy metals.
- UV protection.
- Material: Low-density polyethylene (LDPE)
- Color: Black

Supply:
One 25 m reel



NSYCPT17

Characteristics	Ø Nominal mm (in.)	Ø Inner mm (in.)	Ø Outer mm (in.)	References
Corrugated cable tube	17 (0.67)	16.6 (0.65)	21.2 (0.84)	NSYCPT17
Corrugated cable tube	29 (1.14)	29 (1.14)	34.5 (1.36)	NSYCPT29
Corrugated cable tube	37 (1.46)	36 (1.42)	42.4 (1.67)	NSYCPT37
Corrugated cable tube	50 (1.97)	47.7 (1.88)	54.5 (2.15)	NSYCPT50

Fixing support for corrugated tube

- Mounting options: Directly on the enclosure, on a 19" swing rack and/or on cross-rails, by means of a fixing point.
- The supports can be assembled with one another to form sets of tubes that allow a better arrangement of the cables.
- It allows the rotation of the tube once it is fixed on the support and prevents the corrugated tube from coming loose if subject to pulling movements.
- Material: Polyamide (PA), black.



Supply:
10 units and fixing elements.
The support is supplied with its cover.



NSYCPTS17

Characteristics	Model (nominal Ø)mm (in.)	References
Fixing support for corrugated tube	17 (0.67)	NSYCPTS17
Fixing support for corrugated tube	29 (1.14)	NSYCPTS29
Fixing support for corrugated tube	37 (1.46)	NSYCPTS37
Fixing support for corrugated tube	50 (1.97)	NSYCPTS50

Spiral cable duct

- Spiral strip for bundling cables.
- Allows cables to enter between the body and the door.
- Color: Colorless

Supply:
One 50 m reel



NSYTC12100

Characteristics	Tightening range mm (in.)	Ø Inner mm (in.)	Ø Outer mm (in.)	References
Corrugated cable tube	12 (0.47) to 100 (3.94)	9 (0.35)	12 (0.47)	NSYTC12100

Lyre-shaped clamps

- Clip-on clamps designed for direct installation on the 19" racks, Telequick mounting plates and symmetric DIN rails.
- Color: Black

Supply:
10 units. Reference by unit.
Order by multiples of 10 (10, 20, 30...)



AK2LA39

Characteristics	Use	References
Lyre-shaped clamps	For Telequick mounting plates and 19" racks	AK2LA39
Lyre-shaped clamps	For symmetric DIN rail 90 (3.54) x 2.5 (0.10) mm (in.) cables	AK2LD01
Lyre-shaped clamps	For symmetric DIN rail 75 (2.95) x 2.5 (0.10) mm (in.) cables	AK2LD02

Steel wired cable tray

- Mounting on the cable supports.
- Dimensions (2 types):
1845 (72.64) x 200 (7.87) x 35 (1.38) mm (in.).
1845 (72.64) x 200 (7.87) x 54 (2.13) mm (in.).
- Material: Zinc-coated steel wire

Supply:
1 vertical steel wired cable tray
and fixing elements



NSYBPC3

Characteristics	Necessary depth mm (in.)	References
Steel wired cable tray	35 (1.38)	NSYBPC3
Steel wired cable tray	54 (2.13)	NSYBPC5

Cable-duct

- Temperature resistance: -5°C (23°F) ... +60°C (140°F)
- Behaviour in fire: Material V0 according to UL 94
- Fire resistance: 960°C (1760°F) according to IEC 60695-2-1/1
- Maximum capacity of H07.V.K 1.5 mm² flexible cable (filling factor: 0.6)
- With lateral through slots and rear perforations.
- Material: Rigid PVC
- Color: RAL 7030 grey or RAL 5000 blue
- Standards: Compliance with standards VDE 0660/506 and DIN 43659

Supply:
8 units. Supplied in lengths of 2 m

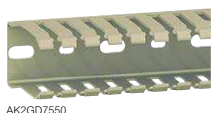

AK2GD7550

Characteristics	Width mm (in.)	Height mm (in.)	Color	References
Cable-duct	25 (0.98)	25 (0.98)	Grey	AK2GD2525
Cable-duct	25 (0.98)	50 (1.97)	Grey	AK2GD2550
Cable-duct	37.5 (1.48)	50 (1.97)	Grey	AK2GD3750
Cable-duct	37.5 (1.48)	75 (2.95)	Grey	AK2GD3775
Cable-duct	50 (1.97)	50 (1.97)	Grey	AK2GD5050
Cable-duct	50 (1.97)	75 (2.95)	Grey	AK2GD5075
Cable-duct	75 (2.95)	50 (1.97)	Grey	AK2GD7550
Cable-duct	75 (2.95)	75 (2.95)	Grey	AK2GD7575
Cable-duct	100 (3.94)	75 (2.95)	Grey	AK2GD10075
Cable-duct	125 (4.92)	75 (2.95)	Grey	AK2GD12575



AK2GA65

Cable-duct	30 (1.18)	35 (1.38)	Blue	AK2GA33
Cable-duct	30 (1.18)	55 (2.16)	Blue	AK2GA35
Cable-duct	30 (1.18)	90 (3.54)	Blue	AK2GA39
Cable-duct	30 (1.18)	144 (5.67)	Blue	AK2GA315
Cable-duct	60 (2.36)	55 (2.16)	Blue	AK2GA65
Cable-duct	60 (2.36)	90 (3.54)	Blue	AK2GA69
Cable-duct	60 (2.36)	144 (5.67)	Blue	AK2GA615

Covers for cable-duct

- Temperature resistance: -5°C (23°F) ... +60°C (140°F)
- Behaviour in fire: Material V0 according to UL 94
- Fire resistance: 960°C (1760°F) according to IEC 60695-2-1/1
- Maximum capacity of H07.V.K 1.5 mm² flexible cable (filling factor: 0.6)
- Replacement covers.
- Material: Rigid PVC
- Color: RAL 7030 grey or RAL 5000 blue
- Standards: Compliance with standards VDE 0660/506 and DIN 43659

Supply:
8 units. Supplied in lengths of 2 m



AK2CD75

Characteristics	Width mm (in.)	Height mm (in.)	Color	For Cable-duct Ref.	References
Covers for cable-duct	25 (0.98)	25 (0.98)	Grey	AK2GD2525	AK2CD25
Covers for cable-duct	25 (0.98)	50 (1.97)	Grey	AK2GD2550	AK2CD25
Covers for cable-duct	37.5 (1.48)	50 (1.97)	Grey	AK2GD3750	AK2CD37
Covers for cable-duct	37.5 (1.48)	75 (2.95)	Grey	AK2GD3775	AK2CD37
Covers for cable-duct	50 (1.97)	50 (1.97)	Grey	AK2GD5050	AK2CD50
Covers for cable-duct	50 (1.97)	75 (2.95)	Grey	AK2GD5075	AK2CD50
Covers for cable-duct	75 (2.95)	50 (1.97)	Grey	AK2GD7550	AK2CD75
Covers for cable-duct	75 (2.95)	75 (2.95)	Grey	AK2GD7575	AK2CD75
Covers for cable-duct	100 (3.94)	75 (2.95)	Grey	AK2GD10075	AK2CD100
Covers for cable-duct	125 (4.92)	75 (2.95)	Grey	AK2GD12575	AK2CD125



AK2CA6

Covers for cable-duct	30 (1.18)	35 (1.38)	Blue	AK2GA33	AK2CA3
Covers for cable-duct	30 (1.18)	55 (2.16)	Blue	AK2GA35	AK2CA3
Covers for cable-duct	30 (1.18)	90 (3.54)	Blue	AK2GA39	AK2CA3
Covers for cable-duct	30 (1.18)	144 (5.67)	Blue	AK2GA315	AK2CA3
Covers for cable-duct	60 (2.36)	55 (2.16)	Blue	AK2GA65	AK2CA6
Covers for cable-duct	60 (2.36)	90 (3.54)	Blue	AK2GA69	AK2CA6
Covers for cable-duct	60 (2.36)	144 (5.67)	Blue	AK2GA615	AK2CA6

S3D SM SF S3X **Ø 22 (0.87) mm (in.) cable-duct support**

SFX SDX PLA



- Installed on the door of the wall-mounted or floor-standing enclosure combined with Ø 22 (0.87) mm (in.) elements.
- Material: Treated steel

Characteristics
Ø 22 (0.87) mm (in.) cable-duct support

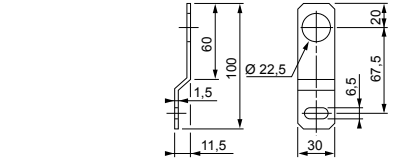

Supply:
10 units. Reference by unit.
Order by multiples of 10 (10, 20, 30...)

References
NSYSPCP

SM SF SD SMX **Cable-duct support on technical upright**

SFX SDX PLA

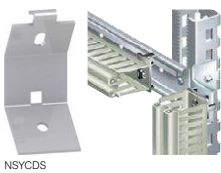

- Allows cable ducts to be installed on technical uprights, while increasing the usable surface of the equipment (up to 20% according to the width of the cable duct).
- Material: Galvanized steel

Characteristics
Cable-duct support on technical upright

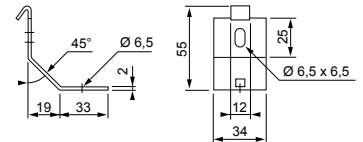

Supply:
10 units. Reference by unit.
Order by multiples of 10 (10, 20, 30...)

References
NSYCDL

Plastic cable-duct support



- Clips onto the Telequick mounting plate or the 35 (1.38) mm (in.) DIN rail.
- Includes a screw for fixing the cable ducts through the 6.5 (0.26) x 14 (0.55) mm (in.) drill holes made in the back.
- The 2 functions, clipping and bolting, provide considerable time savings.
- Respects electrical insulation.
- Material: Black polyamide. Behaviour in fire: V0 according to UL 94

Characteristics
Plastic cable-duct support

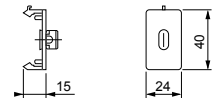

Supply:
20 units. Reference by unit.
Order by multiples of 20 (20, 40, 60...)

References
NSYSPC

Label frame

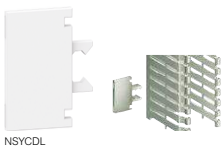

- In transparent plastic, clips onto the slats of the cable ducts.
- Material: Polycarbonate

Characteristics
Label frame

Supply:
50 units. Reference by unit.
Order by multiples of 50 (50, 100, 150...)
Paper labels supplied

References
NSYCDL

Insulated-head screw



- M5 x 10 (0.39) mm (in.) slotted hexagonal head.
- Provides electrical insulation.

Characteristics
Insulated-head screw

Supply:
100 units. Reference by unit.
Order by multiples of 100 (100, 200, 300...)

References
NSYSM10M5HP

Cable-duct support with quick-fixing system



- Fixing mode: By screws - upright location
- Material: Galvanized steel

Characteristics
Cable-duct support with quick-fixing system

Supply:
Set of 3

References
NSYSPCD

Note:
For dimensions see [page 318](#)



Characteristics	Multi-Fixing LED Lamps	
	These LED lamps are designed to optimize the life time, consumption, space and accessibility inside the enclosure, they are available with three fixing options as standard.	
Color	Black RAL 9005	
Ingress protection rating	IP20 according to IEC60529	
Standards	<ul style="list-style-type: none"> IEC 60598 UL 94: For plastic components UL508A: Control Panel 	<ul style="list-style-type: none"> UL1598: Lamps UL8750: LED for lighting EN55015: EMC
Other characteristics	<ul style="list-style-type: none"> Built-in switch Power consumption: 10 W Frequency: 50/60 Hz Power factor: <ul style="list-style-type: none"> V AC lamps: 0.9 V DC lamps: 1 Luminosity: 640 lm* Light temperature: 4000 K* LED service life: 25000 h* 	<ul style="list-style-type: none"> Casing: Plastic UL94 V-0 Degree of insulation: <ul style="list-style-type: none"> Class I - Lamps with socket Class II - Lamps without socket Compliant with RoHS and Reach Ambient temperature: <ul style="list-style-type: none"> Operation: -16°C to +65°C (-3°F to +149°F) Storage: -10°C to +60°C (14°F to +140°F) Max. 2 Apms and 5 lamps in serial connection
Connections	<ul style="list-style-type: none"> 3 (118.11) m (in.) power black or orange cable with quick connector (Not supplied. See reference below) 1.5 (59.06) m (in.) interconnection black or orange cable with quick connectors (Not supplied. See reference below) According to the directive IEC 60204-1: <ul style="list-style-type: none"> Black cables: Power circuits for switch or DC voltage. Orange cables: External voltage that may be present even if the cabinet is turned off. 	
Supply	<ul style="list-style-type: none"> 1 lamp and fixing elements 	

Lamp model	Lamps		Cables			
	Socket	References	Black cables		Orange cables	
			Power (3 (118.11) m (in.)) References	Interconnection (1.5 (59.06) m (in.)) References	Power (3 (118.11) m (in.)) References	Interconnection (1.5 (59.06) m (in.)) References
With socket 120 / 230 V AC	SCHUKO	NSYLAMLDS	NSYLAM3M	NSYLAM1M	NSYLAM3MN	NSYLAM1MN
With socket 120 / 230 V AC	UTE	NSYLAMLDF	NSYLAM3M	NSYLAM1M	NSYLAM3MN	NSYLAM1MN
With socket 120 / 230 V AC	British	NSYLAMLDB	NSYLAM3M	NSYLAM1M	NSYLAM3MN	NSYLAM1MN
Without socket 120 / 230 V AC	-	NSYLAML	NSYLAM3M	NSYLAM1M	NSYLAM3MN	NSYLAM1MN
Without socket	-	NSYLAMLDD	NSYLAM3M	NSYLAM1M	NSYLAM3MN	NSYLAM1MN
With presence detection 230 V AC	-	-	-	-	-	-
Without socket - DC 24-48 V DC	-	NSYLMLDVDC	NSYLAM3MDC	-	-	-
Without socket - DC 24-48 V DC	-	-	NSYLAM3MDCUL	-	-	-

Rack for VDI

- 1 U, 19" rack. For lamp installation in VDI enclosures.

Supply:
supplied with fixing elements.



Characteristics
Rack for VDI

References
NSYLAM1U

Fixing options

Fixing by sliding brackets



Magnetic fixing.



Fixing to DIN rail.

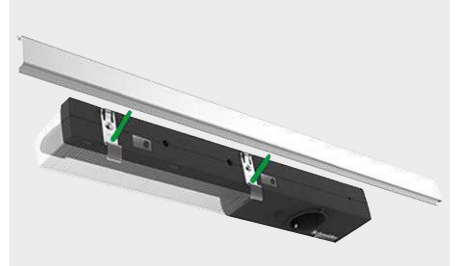

3-pole connectors



NSYLAMACF



NSYLAMDCE



NSYLAMACM



NSYLAMDCEM

- Designed to connect Multi-Fixing LED Lamps.
- Color:
AC: Black
DC: Black (body) and brown (head)
- Ingress protection rating: IP20
- Rated current: 16 A
- Rated voltage: 250 V
- Strain relief: Yes
- Connection type for cabling: Screw connection
- Material: Polyamide
- Dimensions:
Length: 53.2 (2.09) mm (in.)
Width: 23 (0.91) mm (in.)
Height: 13.8 (0.54) mm (in.)

• Connection data:

- Cable diameter: 9 (0.35) mm (in.)
- Cable diameter 2: 5.5 (0.22) mm (in.)
- Cross section solid: 2.5 mm²
- Cross section solid 2: 0.5 mm²
- Connection cross section stranded (max.): 2.5 mm²
- Cross section stranded 2: 0.5 mm²

Characteristics	References
3-pole female connectors AC model	NSYLAMACF
3-pole female connectors DC model	NSYLAMDCE
3-pole male connectors AC model	NSYLAMACM
3-pole male connectors DC model	NSYLAMDCEM

Cost-effective LED lamps

- This LED lamp is designed to optimize costs and can be used in almost all enclosures respecting the dimensions. It can be interconnected using a single power source:
 - 5 W lamps: Max. 10 lamps interconnected,
 - 10 W lamps: Max. 5 lamps interconnected.
- Built-in switch
- Light temperature: 4000 K*
- LED service life: 25000 h*
- Casing:
 - Plastic for transparent cover and connectors
 - Aluminum for body
- Degree of insulation: Class I
- Compliant with RoHS and Reach
- Ambient temperature:
 - Operating: -10°C to +60°C (14°F to +140°F)
 - Storage: -16°C to +65°C (-3°F to +149°F)
- Color: Aluminum
- Ingress protection rating: IP20 according to IEC60529
- Standards: IEC 60598

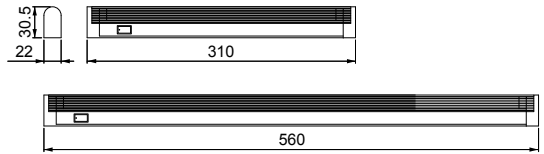

Supply:
 1 lamp and fixing elements
 3 (118.11) m (in.) connection cable with quick connector
 1 (39.37) m (in.) interconnection cable with quick connectors

* Approximate values.



NSYLAMT5LD1

Characteristics	Voltage (V)	Power (W)	Power factor	Frequency (Hz)	Luminous flux (lm)*	References
Cost-effective LED lamps	120/230 V AC	5	0.8	50-60	500	NSYLAMT5LD1
Cost-effective LED lamps	120/230 V AC	10	0.9	50-60	1100	NSYLAMT5LD2
Cost-effective LED lamps	24/48 V DC	5	1	-	470	NSYLAMT5LD1VDC

Portable LED lamp

- This LED portable lamp is designed to be installed as
 - Enclosure lamp or maintenance lamp providing mobility,
 - Resistance, versatility and durability.
- Double function:
 - internal enclosure lamp,
 - maintenance lamp.
- E27 LED lamp
- Built-in recessed switch
- Light temperature: 4000 K*
- LED service life: 25000 h*
- Power cable 3 m long with male plug (European standard type)
- Casing: Plastic, UL94 V-0
- Degree of insulation: Class II
- Compliant with RoHS and Reach
- Ambient temperature:
 - Operating: -16°C to +65°C (-3°F to +149°F)
 - Storage: -10°C to +60°C (14°F to +140°F)
- Color: Black RAL 9005
- Ingress protection rating: IP20 according to IEC60529
- Standards:
 - IEC 60598
 - UL 94: For plastic components

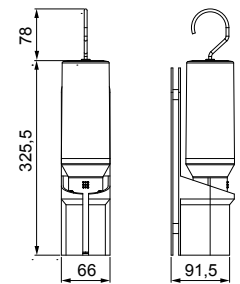

Supply:
 1 lamp with 3 (118.11) m (in.) power cable with European universal plug
 1 fix base
 Fixing elements

* Approximate values.



NSYLAMPORLTD

Characteristics	Voltage (V)	Power (W)	Power factor	Frequency (Hz)	Luminous flux (lm)*	References
Portable LED lamp	120/230 V AC	10	0.5	50-60	1100	NSYLAMPORLTD

Fixing options



Magnetic fixing.



Fixing by adapter brackets.

Possible uses



Fixing by adhesive or by screws.



Used on workbench.

SM SF SD Transport casters*



- Quick installation on plinths with heights of 100 (3.94) and 200 (7.87) mm (in.), except the plinth for enclosure sets.
- They can be installed in front or side position.
- Clipping and fixing to the corner by screws.
- For use on flat surfaces.
- Height: 110 (4.33) mm (in.)
- Maximum load: 200 (440.92) kg (lbs.)

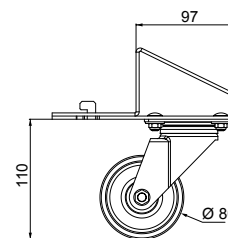

Supply:
4 transport casters
(2 with a blocking system)
and fixing elements

Characteristics

Transport casters

References

NSYSTW

NSYSTW

SM SF SD Enclosure casters



- Double casters.
- Height: 92 (3.62) mm (in.)
- Diameter: 64 (2.52) mm (in.)
- Maximum load:
135 (297.62) kg (lbs.) per caster
1000 (2204.62) kg (lbs.) when it is installed directly on the upright,
400 (881.85) kg (lbs.) when it is installed on the frame

Supply:
4 casters and fixing elements

Characteristics

Enclosure casters

References

NSYSW

NSYSW

SM SF SD Levelling feet



- Height: 42 (1.65) mm (in.)
- Material: Steel
- Maximum load: 400 (881.85) kg (lbs.)

Supply:
Set of 4 floor feet

Characteristics

Levelling feet fixed

References

NSYSPSJ

NSYSPSJ

SM SF SD Levelling feet



- Height: 22 (0.87) mm (in.)
- Maximum load: 400 (881.85) kg (lbs.)

Supply:
Set of 4 floor feet

Characteristics

Levelling feet adjustable

References

NSYSPRJ

NSYSPRJ

SM SF SD Hygienic stainless-steel feet



- Recommended for applications that require special hygiene conditions.
- Material: 316L stainless-steel
- Installation: Adjustable between 140 (5.51) mm (in.) and 200 (7.87) mm (in.) height
- Maximum load: 200 (440.93) kg (lbs.) per foot

Supply:
Set of 4 hygienic feet

Characteristics

Hygienic stainless-steel feet

References

NSYPHX200

NSYPHX200

S3D S3X Door switch for wall-mounted enclosures



- Switch/commutator unit equipped with support and fixings for direct fixing to the enclosure.
- Can be used to control lighting, air-conditioning units, etc.
- Not compatible with the 19" swing rack and the internal door.
- NC + NO contact, 10 A/500 V.

Supply:
1 door switch and fixing elements

Characteristics	References
Door switch for wall-mounted enclosures	NSYINLCRN

SM SF SFX Door switch for floor-standing enclosures



- The switch is fixed to the structure of the enclosure.
- Drilled M20 cable entry for cable gland.
- NC + NO contact, 240 V AC/3 A (IEC 60947-5-1) 250 V DC / 0,1 A (IEC 0947-5-1).

Supply:
1 door switch and fixing elements

Characteristics	For ranges	References
Door switch for floor-standing enclosures	SF and SFX	NSYDCM20
Door switch for floor-standing enclosures	SM	NSYMDCM20

SF SM Metal document pocket



- Direct mounting on the reinforcement frame of the door.
- Adjustable depth with a pitch of 25 (0.98) mm (in.).
- Material: Steel
- Finish: Structured finish, epoxy polyester powder
- Color: RAL 7035 grey

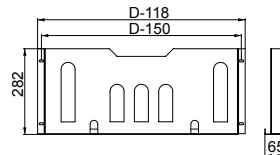

Supply:
1 metal document pocket and fixing elements

Characteristics	Width mm (in.)	References
Spacial SF/SM Metal document pocket	600 (23.62)	NSYSDP6M
Spacial SF/SM Metal document pocket	800 (31.50)	NSYSDP8M

SF SM Plastic document pocket



- Attachment by adhesive tape.
- Material: Polystyrene (PS)
- Color: RAL 7035 grey (NSYDPA4: RAL 9001)

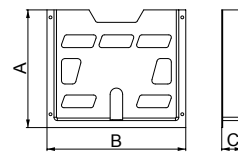

Note:
NSYDPA44 not compatible with 19" chassis or modular distribution.

Supply:
1 plastic document pocket

Characteristics	Doc. format	A mm (in.)	B mm (in.)	C mm (in.)	References
Spacial SF/SM Plastic document pocket	A5	174 (6.85)	188 (7.40)	22 (0.87)	NSYDPA5
Spacial SF/SM Plastic document pocket	A4	230 (9.06)	247 (9.72)	23 (0.91)	NSYDPA4
Spacial SF/SM Plastic document pocket	A4	234 (9.21)	278 (10.94)	40 (1.58)	NSYDPA44
Spacial SF/SM Plastic document pocket	A3	285 (11.22)	476 (18.74)	35 (1.38)	NSYDPA3

SF SM Folding support tray



NSYSDT5

- Adjustable horizontal support for laptop computers, documents or any other element.
- Installation on the reinforcement frame of the door.
- Can also be installed on the door cross-rails.
- 4 positions: 45°, 60°, 75° and 90°.
- Maximum load: 30 (66.14) kg (lbs.)
- Material: Steel
- Finish: Structured finish, epoxy polyester powder
- Color: RAL 7035 grey

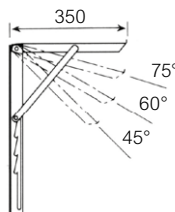

Supply:
1 folding support tray and fixing elements



NSYSDT8

Characteristics	Width of enclosure mm (in.)	Width of tray mm (in.)	References
Spacial SF/SM-Folding support tray	500 (19.68)	325 (12.80)	NSYSDT5
Spacial SF/SM-Folding support tray	600 (23.62)	425 (16.73)	NSYSDT6
Spacial SF/SM-Folding support tray	800 (31.50)	625 (24.61)	NSYSDT8

Door cross-rails



NSYSDCR4

- Direct mounting cross-rails on the profiles of the reinforcement frame of the door.
- Adjustable height with a pitch of 25 (0.98) mm (in.).
- Material: Galvanized steel
- Thickness: 20 (0.79)/10° mm (in.)

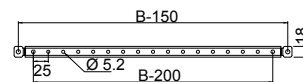

Supply:
2 cross-rails and bag of fixings

Characteristics	Width (B) mm (in.)	References
Door cross-rails	400 (15.75)	NSYSDCR4
Door cross-rails	500 (19.68)	NSYSDCR5
Door cross-rails	600 (23.62)	NSYSDCR6
Door cross-rails	800 (31.50)	NSYSDCR8
Door cross-rails	1000 (39.37)	NSYSDCR10

SM Door retainer for floor-standing enclosure



NSYSMDR

- Door retainer locking the door in open position.
- It is fixed directly to the front frame of them enclosure and to the reinforcement frame of the door.
- It can be installed on doors that open both to the right and to the left.

Supply:
Door stop and fixing elements

Characteristics	Limit	References
Door retainer locking the door in open position	90°	NSYSMDR
Door retainer locking the door in open position, compatible with SFX	90° and 120°	NSYSMNR

SF Door retainer for floor-standing enclosure

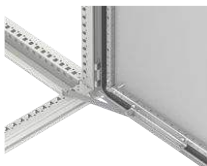

NSYSFMDR

- Door retainer locking the door in open position.
- It is fixed directly to the front frame of them enclosure and to the reinforcement frame of the door.
- It can be installed on doors that open both to the right and to the left.

Supply:
Door stop and fixing elements

Characteristics	Limit	References
Floor-standing door retainer	90° and 120°	NSYSFMDR
Floor-standing door retainer	120°	NSYSFNDR



CRN S3D S3X Door retainer for wall-mounted steel enclosure

Door retainer locking the door in open position

- It is installed on enclosures with heights from 400 (15.75) mm (in.) and widths from 300 (11.81) mm (in.).
- Door opening angle: 120°.
- Earthing connection of the enclosure by means of the reinforcement rail.
- Earthing accessories supplied with the enclosure (earth-connection cable to be ordered separately), see [page 303](#).
- Material: Steel



NSYAEDRSCST

Note:
Cannot be installed on 19" mounting plates or on enclosures equipped with internal door.

Characteristics	References
Door retainer for wall-mounted steel enclosure	NSYAEDRSCST

S3D Door retainer for wall-mounted polyamide enclosure

Door retainer locking the door in open position

- It is installed on the perforated rails of the enclosure doors at the required height.
- Material: Polyamide 6 (PA6)



NSYAEDRS3DPA6

Note:
It is only installed on enclosures with a height of less than 400 (15.75) mm (in.) (no perforated rails).

Characteristics	References
Door retainer for wall-mounted polyamide enclosure	NSYAEDRS3DPA6

Window for modular equipment

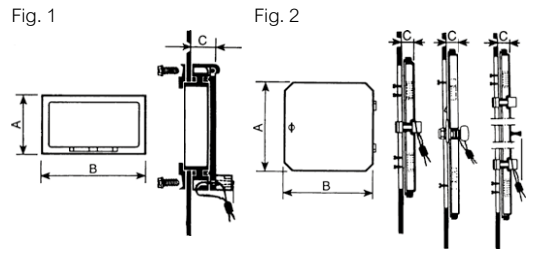

Supply:
1 window

- Material: Transparent polycarbonate



NSYVA2728M

Characteristics	N.° of modules	Fig. n.°	A	B	C	References
Window for modular equipment, Low cover	2	1	78	60	15	NSYVA2722M
Window for modular equipment, Low cover	4	1	78	95	15	NSYVA2744M
Window for modular equipment, Low cover	6	1	78	130	15	NSYVA2766M
Window for modular equipment, Low cover	8	1	78	165	15	NSYVA2788M
Window for modular equipment, Low cover	10	1	78	200	15	NSYVA2710M
Window for modular equipment, Low cover	12	1	78	235	15	NSYVA2712M
Window for modular equipment, High cover	2	1	78	60	25	NSYVA2722MA
Window for modular equipment, High cover	4	1	78	95	25	NSYVA2744MA
Window for modular equipment, High cover	6	1	78	130	25	NSYVA2766MA
Window for modular equipment, High cover	8	1	78	165	25	NSYVA2788MA
Window for modular equipment, High cover	10	1	78	200	25	NSYVA2710MA
Window for modular equipment, High cover	12	1	78	235	25	NSYVA2712MA
Window for modular equipment, Low cover	16	2	195	165	13	NSYVA2716M
Window for modular equipment, Low cover	24 in 2 rows	2	196	235	13	NSYVA2724M



NSYVA2724M

Plastic window

- Plastic window with hinged cover for installation in front panel.
- External dimensions: 213 x 133 mm.
- Internal dimensions of the window: 180 x 78 mm.
- Material:
 - Cover: Polycarbonate
 - Body: PVC

Supply:
1 plastic window delivered with a drilling template



NSYMW10M

Characteristics	References
Plastic window	NSYMW10M

Plastic window for modular equipment

- Frame with transparent hinged cover for mounting modular switchgear on the front panel.
- Opening: 46 x 180 mm (10 modules).
- Material:
 - Cover: Polycarbonate
 - Body: PVC

Supply:
1 modular front panel



NSYMW10MK

Characteristics	References
Plastic window for modular equipment	NSYMW10MK

Kit for fixing the switchgear

- The unit is delivered assembled.

Supply:
1 DIN rail and two supports.



NSYMW10MR

Characteristics	References
Kit for fixing the switchgear	NSYMW10MR

Mounting example

NSYMW10MK + NSYMW10MR.



Technical changes reserved. Information provided without guarantee. Images are for illustrative purposes only.

Control window

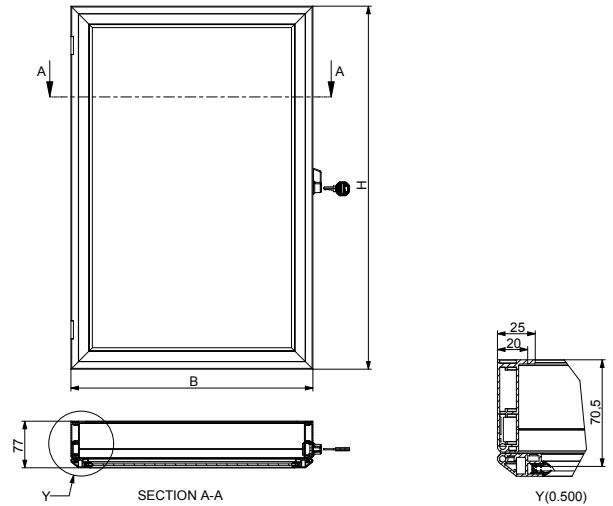

- To prevent accidental operation of the control units by any unauthorised person.
- Allows the displayed information to be read without opening the door.
- Equipped with hinges for opening (180°).
- Locked by a n° 2233X lock.
- Indoor installation.
- Material: Aluminum frame and 3 (0.12) mm (in.) acrylic window

Supply:
1 window, fixings
and instruction sheet



NSYCW33

Characteristics	Dimensions A mm (in.)	Dimensions B mm (in.)	References
Control window	300 (11.81)	300 (11.81)	NSYCW33
Control window	400 (15.75)	400 (15.75)	NSYCW44
Control window	400 (15.75)	500 (19.68)	NSYCW45
Control window	400 (15.75)	600 (23.62)	NSYCW46
Control window	500 (19.68)	400 (15.75)	NSYCW54
Control window	500 (19.68)	500 (19.68)	NSYCW55
Control window	500 (19.68)	600 (23.62)	NSYCW56
Control window	600 (23.62)	500 (19.68)	NSYCW65
Control window	600 (23.62)	600 (23.62)	NSYCW66
Control window	800 (31.50)	600 (23.62)	NSYCW86

Earthing strip

- Perforated brass bar, 15 (0.59) x 3 (0.12) mm (in.).
- 1 (39.37) m (in.) long.
- 87 connection points, M5 drill holes



NSYECB1M153

Characteristics
Earthing strip

Supply:
1 earthing strip
and fixing elements

References

NSYECB1M153

S3D S3X Fixing lugs for the earthing strip



NSYEDCOS

- They allow the mounting of an earthcollector rail or a DIN rail at the top and bottom of an enclosure.
- Mounting incompatible with certain accessories. Please consult us.
- Fixing: On holes made in the gutter of the enclosure.

Characteristics

Fixing lugs for the earthing strip

Supply:
2 lugs and fixings.

References

NSYEDCOS

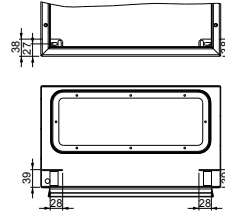

SM SF SD Central earthing point

SMX SFX SDX



NSYCEP

- Connects earthing braids and cables to the structure of the enclosure.
- The earth connection is made by means of the M8 x 18 (0.71) mm (in.) screw.
- Fixing: Fixing to the structure by means of self-tapping screws

Characteristics

Central earthing point

Supply:
1 central earthing point, elements
for fixing to the structure,
and fixings for fixing to the screw

References

NSYCEP

Earth braids

- They guarantee the earth connection for high frequencies, avoiding the disturbing electric currents that are produced.
- Material: Tinned copper.



NSYEB156D6

Characteristics	Section (mm ²)	Terminal Ø mm (in.)	Length mm (in.)	Width mm (in.)	References
Earth braids	6	7 (0.28)	150 (5.91)	12 (0.47)	NSYEB156D6
Earth braids	10	6.5 (0.26)	150 (5.91)	17 (0.67)	NSYEB1510D6
Earth braids	16	8.5 (0.34)	155 (6.10)	17 (0.67)	NSYEB1516D8
Earth braids	25	8.5 (0.34)	200 (7.87)	27 (1.06)	NSYEB2025D8
Earth braids	50	8.5 (0.34)	200 (7.87)	33 (1.30)	NSYEB2050D8

Supply:
10 earth braids
(nuts and washers not included)

Earth cables

- Make it easier to install a safe earth connection, with a perfect contact, with optimized length.
- Material: Brass and copper alloy terminal, green and yellow PVC insulated sheath



NSYEL136D6

Characteristics	Section (mm ²)	Terminal Ø mm (in.)	Length mm (in.)	References
Earth cables	6	6.4 (0.25)	130 (5.12)	NSYEL136D6
Earth cables	6	6.4 (0.25)	160 (6.30)	NSYEL166D6
Earth cables	6	8.3 (0.33)	160 (6.30)	NSYEL166D8
Earth cables	10	8.3 (0.33)	170 (6.69)	NSYEL1710D6
Earth cables	6	6.4 (0.25)	220 (8.66)	NSYEL226D6
Earth cables	6	13 (0.51)	220 (8.66)	NSYEL226D13
Earth cables	25	8.3 (0.33)	220 (8.66)	NSYEL2225D8
Earth cables	10	6.4 (0.25)	250 (9.84)	NSYEL2510D6
Earth cables	25	8.3 (0.33)	350 (13.78)	NSYEL3525D8

Supply:
10 earth cables (nuts and washers
not included). Reference by unit.
Order by multiples of 10
(10, 20, 30...)

Plain and silkscreened mounting plates

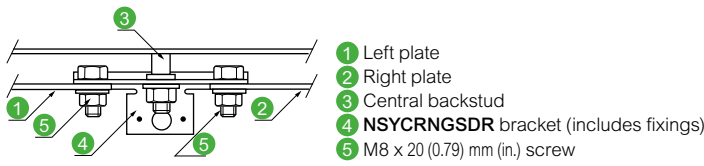
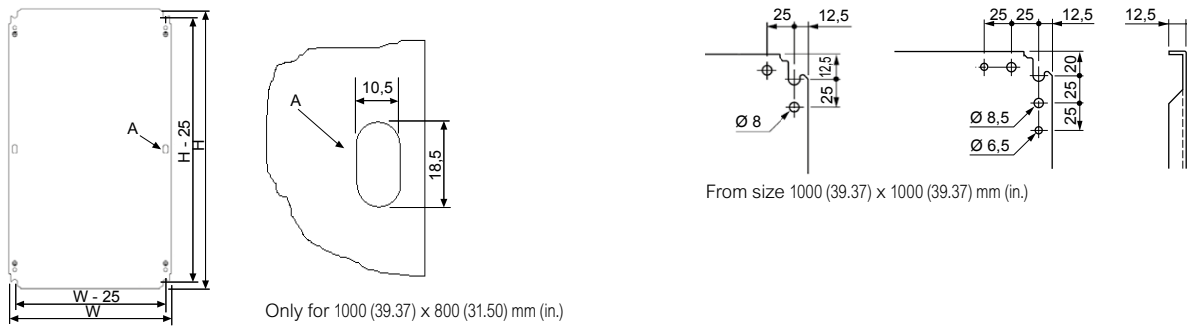

Microperforated mounting plate

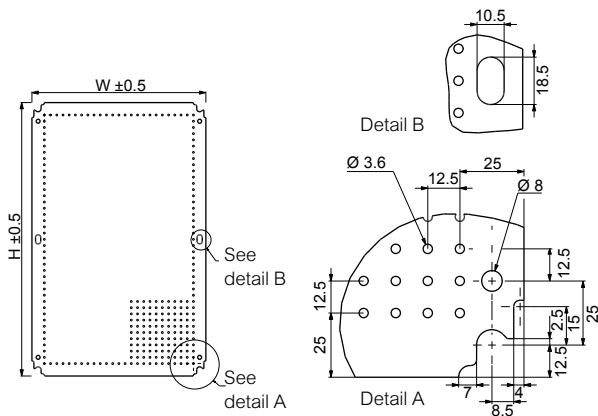

Telequick mounting plate

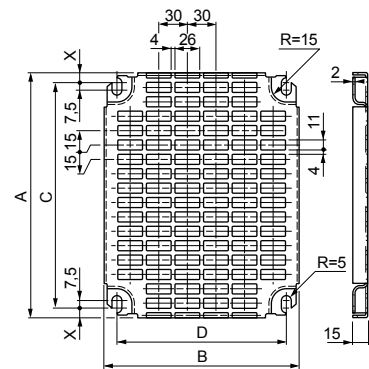

Joinable Telequick mounting plate

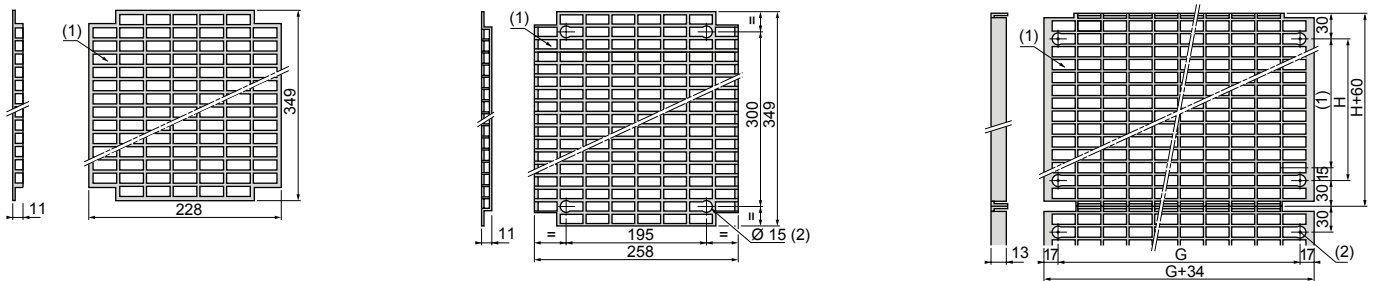

10

Mounting Plates for Wall-Mounted Enclosures

Dimensions

Bakelite and polyester mounting plate

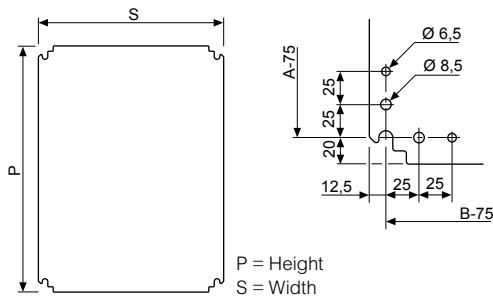

DIN rail chassis

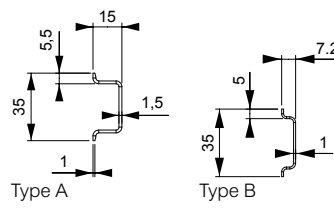

Step slides for mounting plate

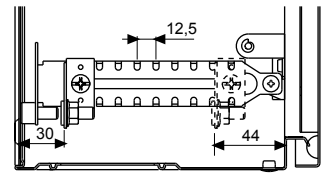

Step slides for 2 mounting plates in one enclosure

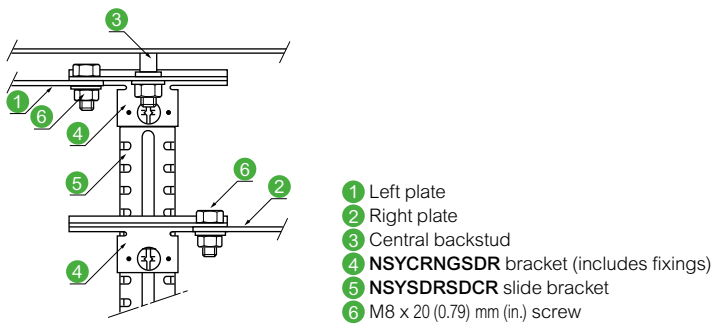

Vertical Rails for Wall-Mounted Enclosures

Dimensions

Slides and brackets

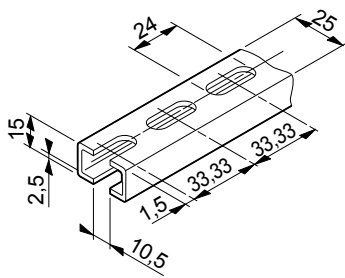

Uprights

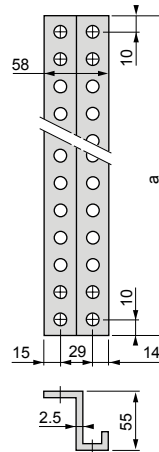

Plain mounting plate

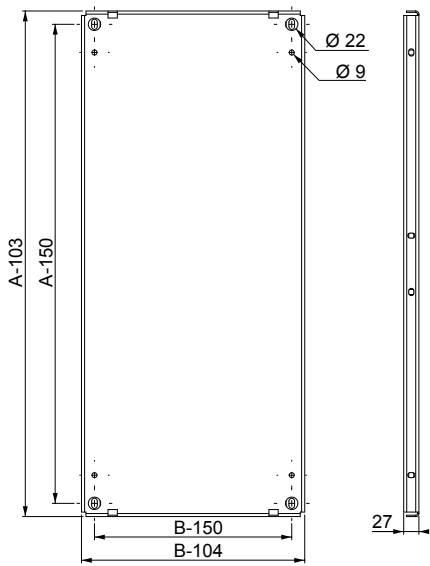

Partial mounting plate

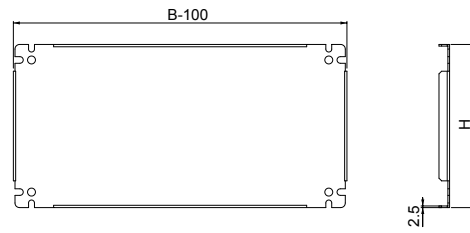

Perforated mounting plate Telequick

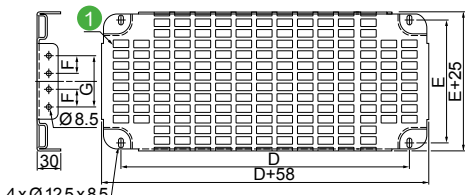

① Cut-outs 11 (0.43) x 26 (1.02) mm (in.) with a pitch of 15 (0.59) x 30 (1.18) mm (in.)

Examples of perforated mounting plate installation

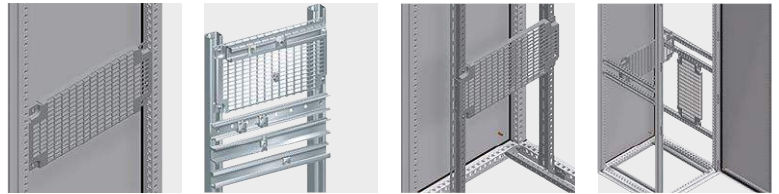

- Perforated plate mounted on structure.
- Perforated plate mounted on technical vertical uprights.
- Perforated plate mounted on standard vertical uprights.
- Perforated plate mounted on cross-rails.

Intermediate mounting plate

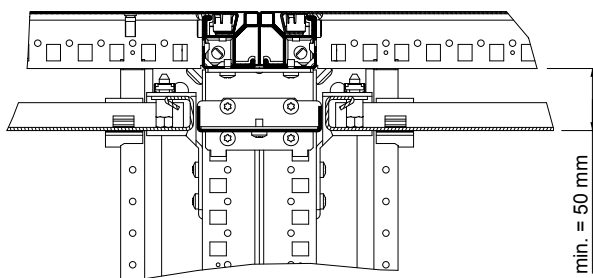

Reinforcement for mounting plate

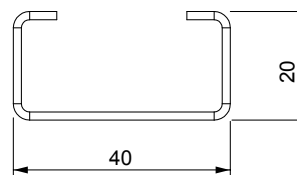

10

Mounting Plate Brackets for Floor-Standing Enclosures Dimensions

Brackets for fixing mounting plates in back-to-back position



Brackets for fixing intermediate mounting plates in back-to-back position

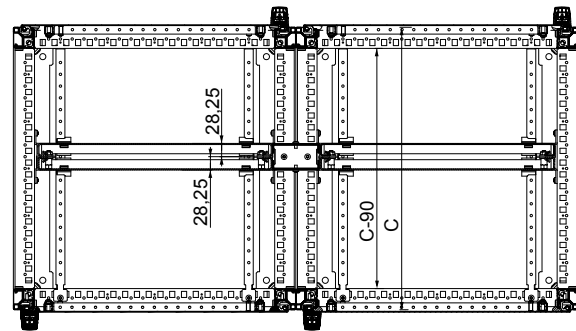

Mounting plates for floor-standing enclosures Dimensions

Examples of combination

Length of joined Spacial SF enclosures mm (in.)	Example of Spacial SF enclosure combination width mm (in.) (B)	Example of combining mounting plates by width mm (in.)	Useful length mm (in.)
1200 (47.24)	1200 (47.24)	600 (23.62) + 800 (31.50)	1192 (46.93)
1400 (55.12)	600 (23.62) + 800 (31.50)	600 (23.62) + 1000 (39.37)	1392 (54.80)
1600 (62.99)	2 x 800 (31.50)	800 (31.50) + 1000 (39.37)	1592 (62.68)
1800 (70.87)	3 x 600 (23.62)	800 (31.50) + 1200 (47.24)	1792 (70.55)
2000 (78.74)	2 x 1000 (39.37)	1000 (39.37) + 1200 (47.24)	1992 (78.42)
2200 (86.61)	600 (23.62) + 2 x 800 (31.50)	1200 (47.24) + 1200 (47.24)	2192 (86.30)
2400 (94.49)	3 x 800 (31.50)	1600 (62.99) + 1000 (39.37)	2392 (94.17)
2400 (94.49)	3 x 800 (31.50)	3 x 600 (23.62) + 1000 (39.37)	2384 (93.86)
2600 (102.36)	2 x 1000 (39.37) + 600 (23.62)	1600 (62.99) + 1200 (47.24)	2592 (102.05)
2600 (102.36)	2 x 1000 (39.37) + 600 (23.62)	3 x 600 (23.62) + 1200 (47.24)	2584 (101.73)
2800 (110.24)	2 x 1000 (39.37) + 800 (31.50)	4 x 800 (31.50)	2784 (109.61)
3000 (118.11)	3 x 1000 (39.37)	3 x 800 (31.50) + 1000 (39.37)	2984 (117.48)
3200 (125.98)	2 x 1000 (39.37) + 1200 (47.24)	3 x 800 (31.50) + 1200 (47.24)	3184 (125.35)
3400 (133.86)	3 x 800 (31.50) + 1000 (39.37)	800 (31.50) + 3 x 1000 (39.37)	3384 (133.23)
3600 (141.73)	3 x 1200 (47.24)	4 x 1000 (39.37)	3584 (141.10)
3800 (149.61)	800 (31.50) + 3 x 1000 (39.37)	600 (23.62) + 3 x 1200 (47.24)	3784 (148.98)
4000 (157.48)	4 x 1000 (39.37)	800 (31.50) + 3 x 1200 (47.24)	3984 (156.85)

Technical uprights

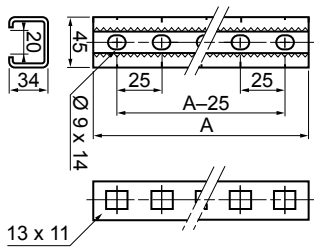

Standard uprights

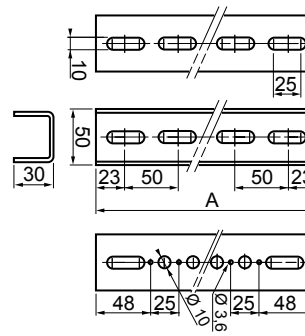

Cross-Rails for Floor-Standing Enclosures

Universal cross-rails

40 (1.58) mm (in.) (1 row)



65 (2.56) mm (in.) (2 rows)



90 (3.54) mm (in.) (3 rows)

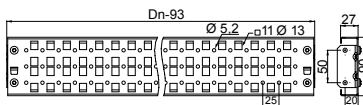

Quick-fixing cross-rails

40 (1.58) mm (in.) (1 row)



65 (2.56) mm (in.) (2 rows)

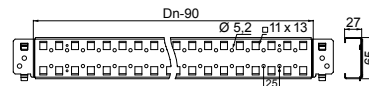

90 (3.54) mm (in.) (3 rows)

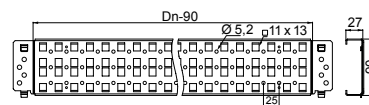

10

Light cross-rails

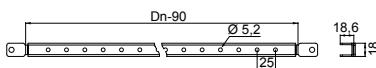

Cross-rail for Lütze chassis

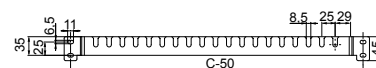

Support for Lütze chassis

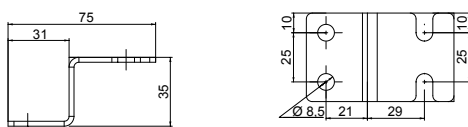

Vertical adaptation profiles

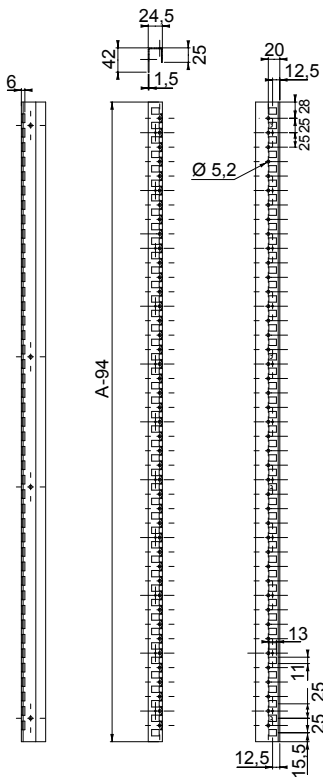

Horizontal adaptation profiles

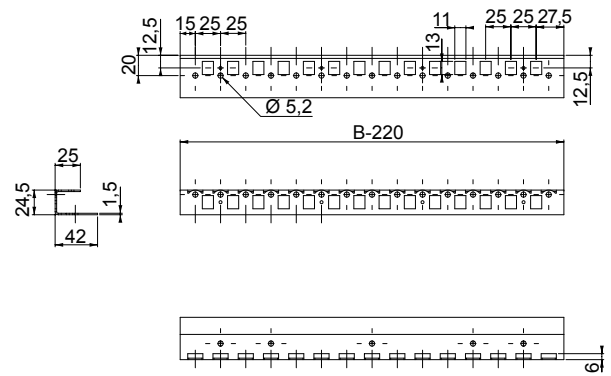

Symmetric mounting rail for wall-mounted enclosures

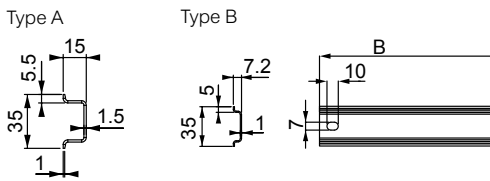

Symmetric DIN rails for floor-standing enclosures

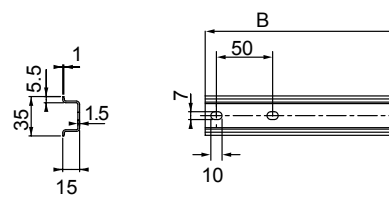

Asymmetric DIN rails for floor-standing enclosures

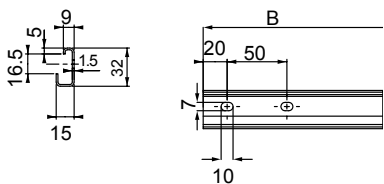

Double-profile DIN rails

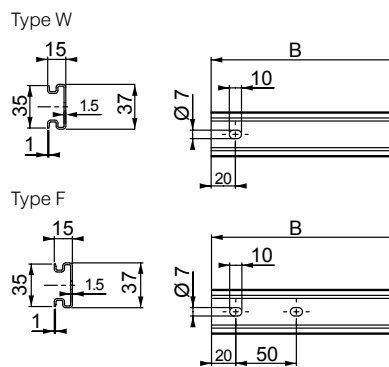

Serrated C-shaped rail for heavy loads

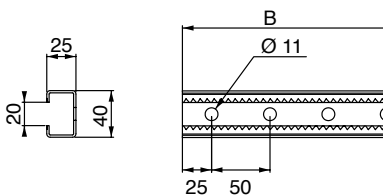

Symmetric C-shaped rails

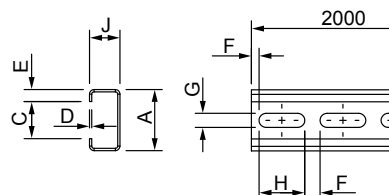

Type	Dimensions mm (in.)								References
	A	J	C	D	E	F	G	H	
C20 Not perforated	21 (0.83)	11 (0.43)	10 (0.39)	1.5 (0.06)	5.5 (0.22)	-	-	-	NSYCN20
C20	21 (0.83)	11 (0.43)	10 (0.39)	1.5 (0.06)	5.5 (0.22)	5 (0.20)	6.2 (0.24)	15 (0.59)	NSYCNT20
C40 Not perforated	40 (1.58)	20 (0.79)	24 (0.94)	1.5 (0.06)	8 (0.32)	-	-	-	NSYCN40
C40	40 (1.58)	20 (0.79)	24 (0.94)	1.5 (0.06)	8 (0.32)	10 (0.39)	8.5 (0.34)	30 (1.18)	NSYCNT40

2000 (78.74) mm (in.) Rails

Dimensions

Symmetric rails

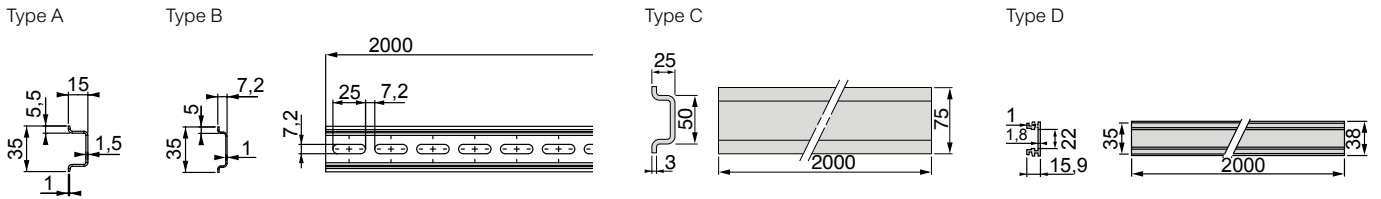

Asymmetric DIN rails

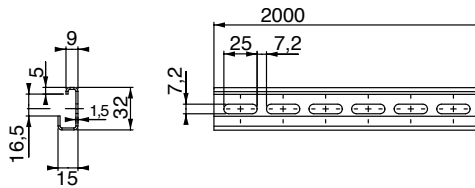

Double-profile DIN rails

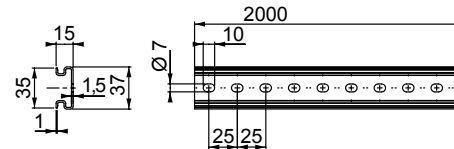

Connectors for Symmetric C-Shaped Rails

Dimensions

Examples



Combinations with connectors for symmetric C-shaped rails

EMA connectors

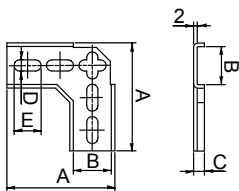

Dimensions mm (in.)					References
A	B	C	D	E	
60 (2.36)	21.3 (0.84)	6 (0.24)	6.2 (0.24)	15 (0.59)	NSYEMA20
100 (3.94)	40.3 (1.59)	10 (0.39)	8.5 (0.34)	25 (0.98)	NSYEMA40

EVA connectors

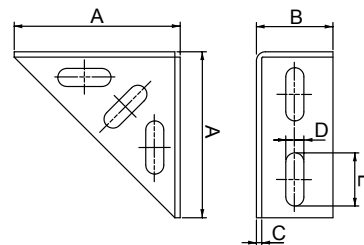

Dimensions mm (in.)					References
A	B	C	D	E	
43 (1.69)	19 (0.75)	2 (0.08)	6.2 (0.24)	15 (0.59)	NSYEVA20
78 (3.07)	36 (1.42)	2.5 (0.10)	8.5 (0.34)	25 (0.98)	NSYEVA40

Connectors for Symmetric C-Shaped Rails

Dimensions

UCA connectors

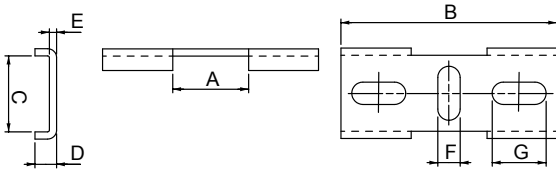

Dimensions mm (in.)							References
A	B	C	D	E	F	G	
21.3 (0.84)	60 (2.36)	21.3 (0.84)	6 (0.24)	2 (0.08)	6.2 (0.24)	15 (0.59)	NSYUCA22
40.3 (1.59)	116 (4.57)	40.3 (1.59)	10 (0.39)	2.5 (0.10)	8.5 (0.34)	25 (0.98)	NSYUCA44

UTA connectors

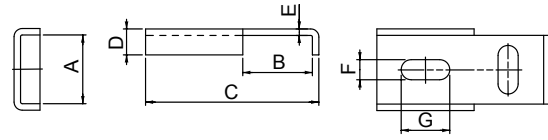

Dimensions mm (in.)							References
A	B	C	D	E	F	G	
21.3 (0.84)	21.5 (0.85)	53.5 (2.11)	8 (0.32)	2 (0.08)	6.2 (0.24)	15 (0.59)	NSYUTA22
21.3 (0.84)	40.5 (1.59)	72.5 (2.85)	8 (0.32)	2 (0.08)	6.2 (0.24)	15 (0.59)	NSYUTA42
40.3 (1.59)	40.5 (1.59)	81 (3.19)	10 (0.39)	2.5 (0.10)	8.5 (0.34)	25 (0.98)	NSYUTA44

ECA connectors

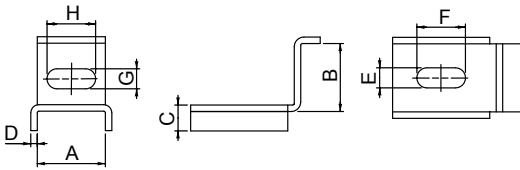

Dimensions mm (in.)								References
A	B	C	D	E	F	G	H	
21.3 (0.84)	21.5 (0.85)	8 (0.32)	2 (0.08)	6.2 (0.24)	15 (0.59)	6.2 (0.24)	15 (0.59)	NSYECA22
21.3 (0.84)	40.5 (1.59)	8 (0.32)	2 (0.08)	6.2 (0.24)	15 (0.59)	6.2 (0.24)	13 (0.51)	NSYECA42
40.3 (1.59)	40.5 (1.59)	10 (0.39)	2.5 (0.10)	8.5 (0.34)	25 (0.98)	8.5 (0.34)	25 (0.98)	NSYECA44

UR connectors

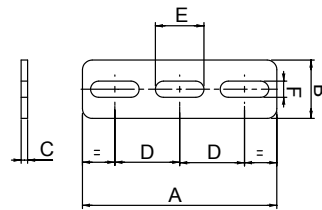

Dimensions mm (in.)						References
A	B	C	D	E	F	
60 (2.36)	18 (0.71)	2 (0.08)	20 (0.79)	15 (0.59)	5 (0.20)	NSYUR20
130 (5.12)	36 (1.42)	3 (0.12)	40 (1.58)	30 (1.18)	10 (0.39)	NSYUR40
130 (5.12)	55 (2.16)	3 (0.12)	40 (1.58)	30 (1.18)	10 (0.39)	NSYUR60

UT connectors

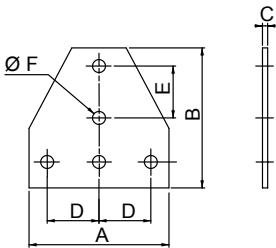

Dimensions mm (in.)						References
A	B	C	D	E	F	
54 (2.13)	54 (2.13)	2 (0.08)	20 (0.79)	20 (0.79)	5 (0.20)	NSYUT20
60 (2.36)	80 (3.15)	2 (0.08)	20 (0.79)	25 (0.98)	8 (0.32)	NSYUT40
80 (3.15)	110 (4.33)	2 (0.08)	20 (0.79)	29 (1.14)	10 (0.39)	NSYUT60

EN connectors

NSYEN20

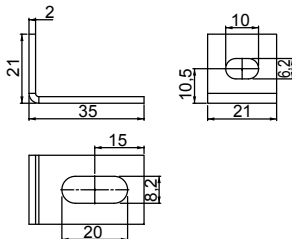

NSYEN40

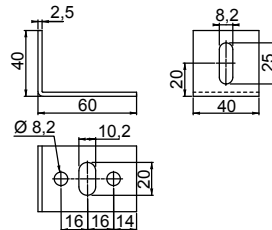

NSYEN60

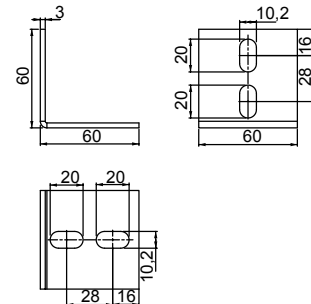

Technical changes reserved. Information provided without guarantee. Images are for illustrative purposes only.

Mounting Spacers

Dimensions

Hexagonal spacers

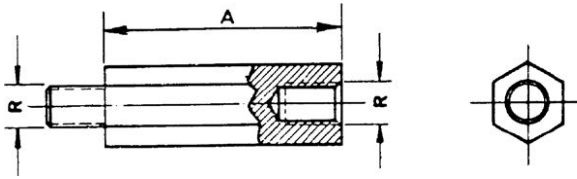

ETU modular spacers

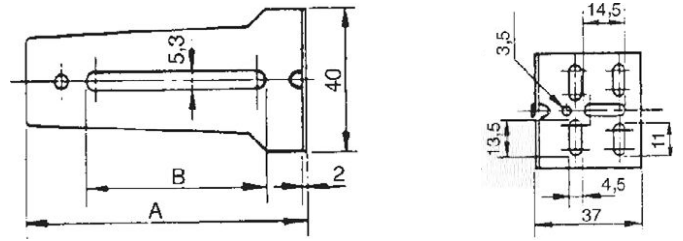

Dimensions mm (in.)		Combination of spacers
Minimum height	Maximum height	References
53 (2.09)	53 (2.09)	NSYETU48 + NSYETU48
63 (2.48)	63 (2.48)	NSYETU48 + NSYETU58
85 (3.35)	85 (3.35)	NSYETU48 + NSYETU79
124 (4.88)	124 (4.88)	NSYETU48 + NSYETU118
73 (2.87)	73 (2.87)	NSYETU58 + NSYETU58
94 (3.70)	94 (3.70)	NSYETU58 + NSYETU79
134 (5.28)	134 (5.28)	NSYETU58 + NSYETU118
84 (3.31)	84 (3.31)	NSYETU79 + NSYETU79
124 (4.88)	124 (4.88)	NSYETU79 + NSYETU118
164 (6.46)	164 (6.46)	NSYETU118 + NSYETU118

Cable Management – Cable Entries

Dimensions

Multi-C

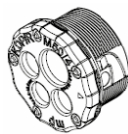
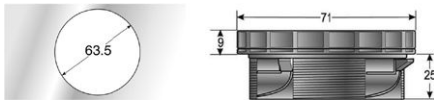

NSYTSAM504SE

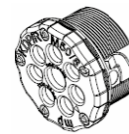

NSYTSAM638SE

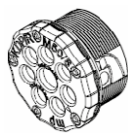
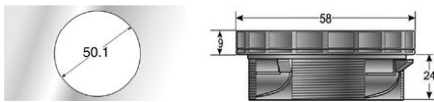

NSYTSAM508SE



NSYTSAM6313SE

Position of the holes on the circular cable entries with diameters 50 (1.97) and 63 (2.48) mm (in.)

Multi-R

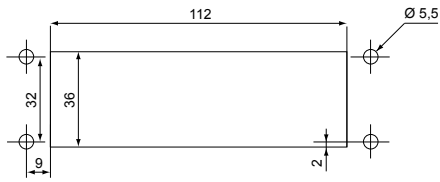

Diagrams of dimensions and positions of the holes on a rectangular cable entry

NSYSA2414SE

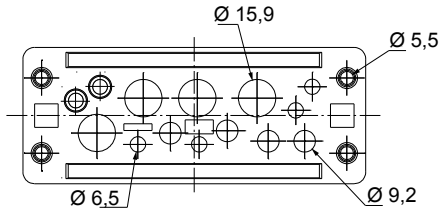

NSYSA2417SE

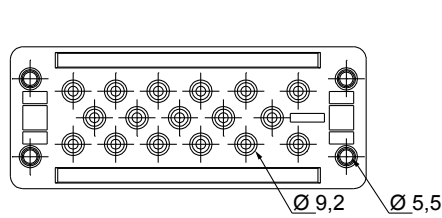

NSYSA2429SE

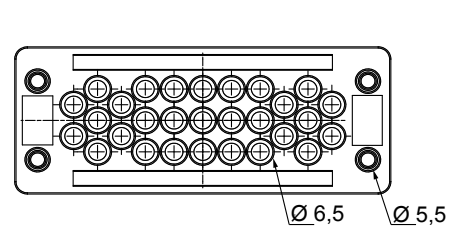

NSYSA2422SE

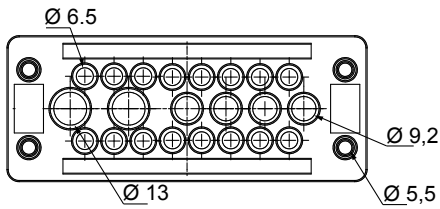

NSYSA2423SE

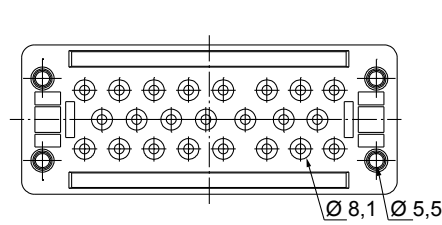

Multi-T

NSYAECFLBP

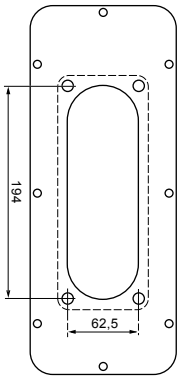

NSYAECFLT7

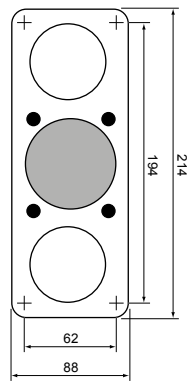

NSYAECFLT25

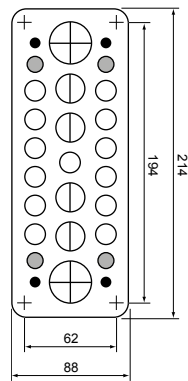

NSYAECFLT35

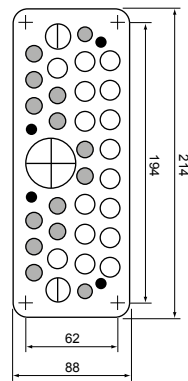

Multi-H

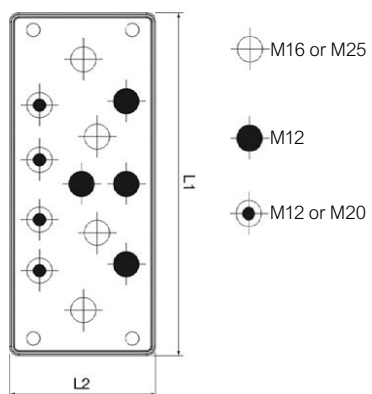

Multi-F

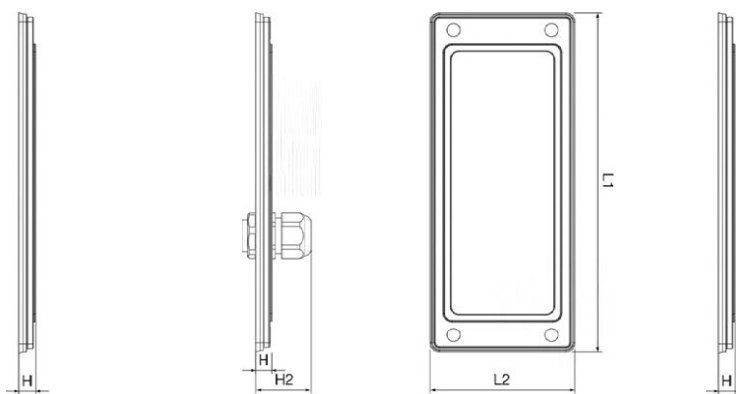

Multi-CR

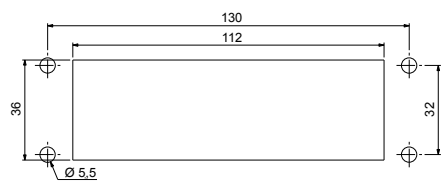

Cut-out for reference NSYDCE24●●●

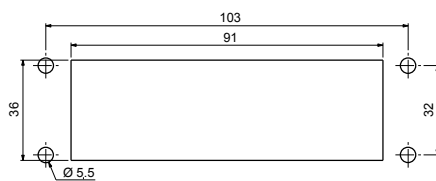

Cut-out for reference NSYDCE16●●●

Multi-CS

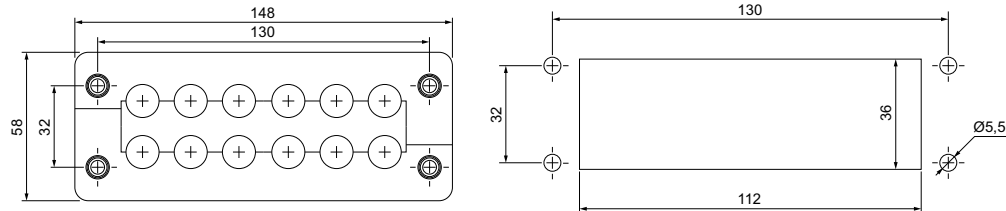

Multi-CF

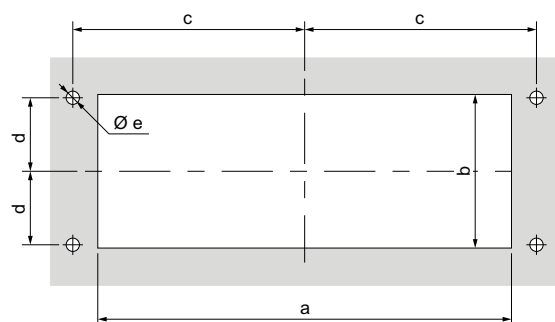

Steel adapter plate for FL13 and FL21 membranes

Application example

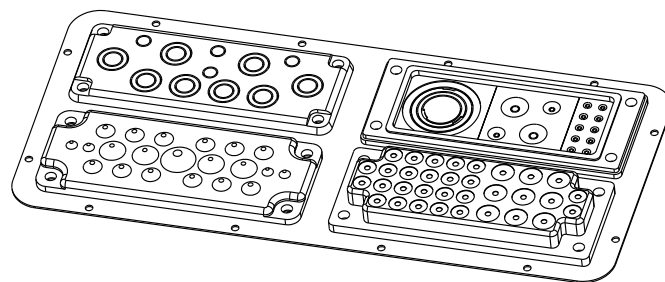
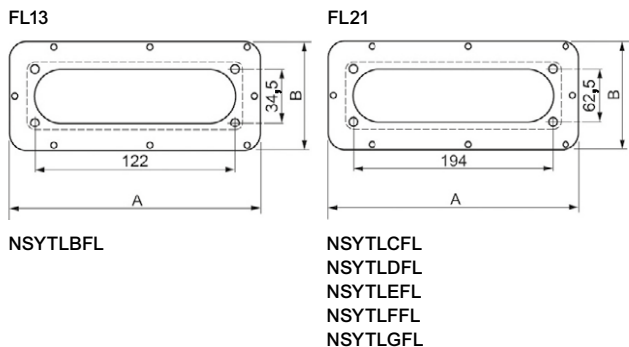

Our membrane can be easily adapted to fit onto all our metal enclosures using the adapter plate.

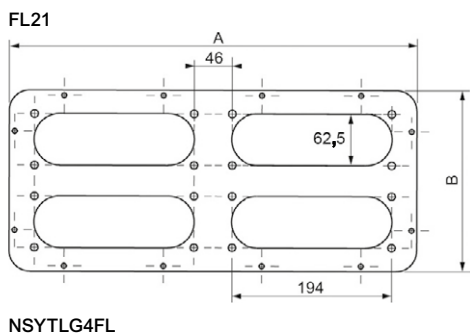
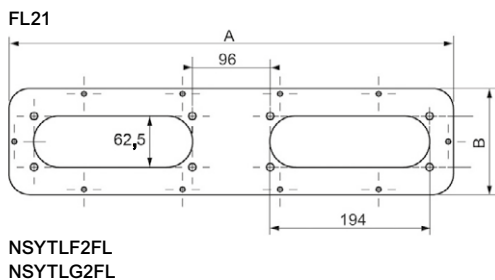

Lower cable-guide cross-rail

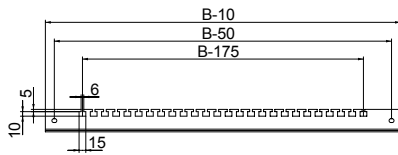

L-rail for fixing cables

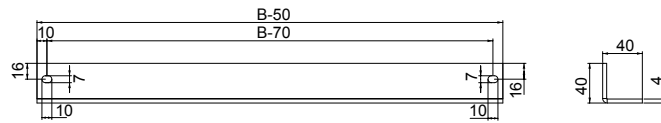

Door cable-guide cross-rail

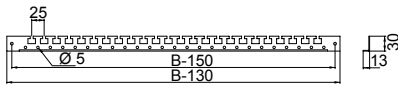

Plastic cable support

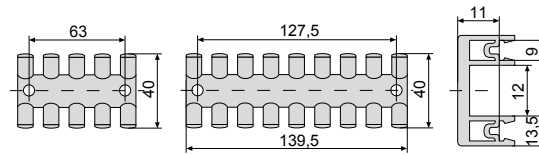

Door cable-guide cross-rails for wall-mounted enclosures

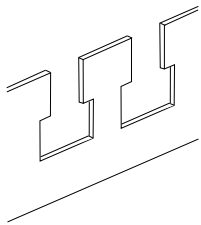

Cable Management – Ducts

Ø 22 (0.87) mm (in.) cable-duct support

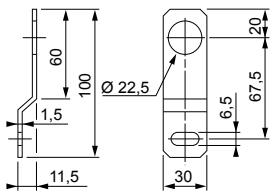

Cable-duct support on technical upright

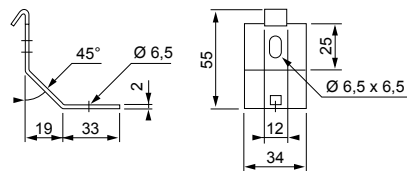

Plastic cable-duct support

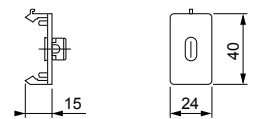

Technical changes reserved. Information provided without guarantee. Images are for illustrative purposes only.

Multi-Fixing LED Lamps

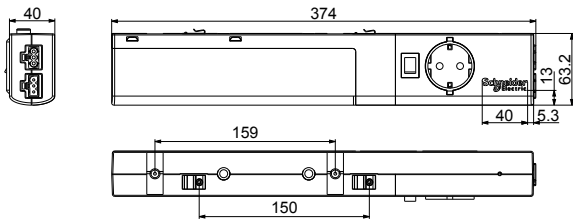

Fixing options



Fixing by sliding brackets



Magnetic fixing.



Fixing to DIN rail.

Cost-effective LED Lamps

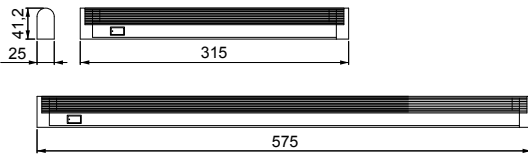

Fixing options



Magnetic fixing



Fixing by adapter brackets

Portable LED lamp

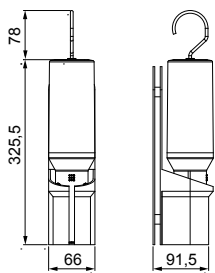

Possible uses



Fixing by adhesive or by screws



Used on workbench

Casters and Feet for Floor-Standing Enclosures

Transport casters only for Spacial SM, SF and SD

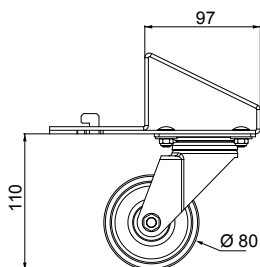

Door accessories - plastic document pocket

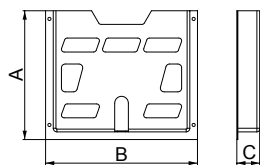

Door accessories - metal document pocket

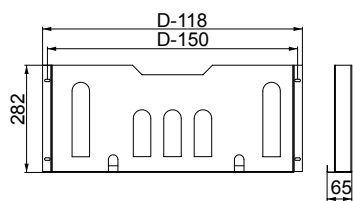

Door Accessories for Floor-Standing Enclosures

Folding support tray

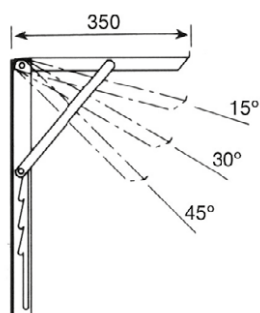

Door cross-rails

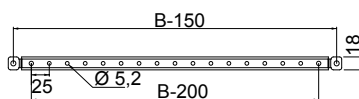

Window for modular equipment

Fig. 1

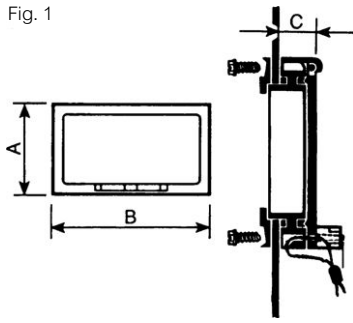
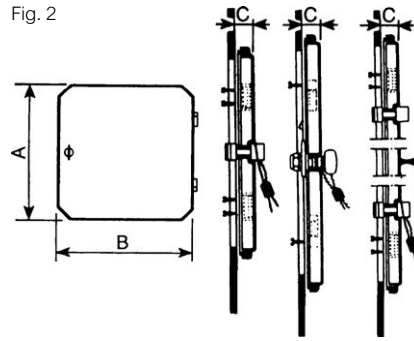
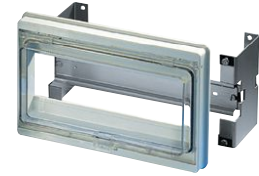

Fig. 2



Plastic window for modular equipment

Mounting example



NSYMW10MK + NSYMW10MR

Control window

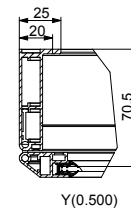
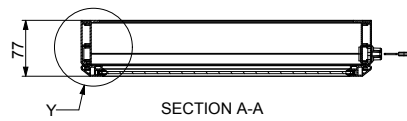
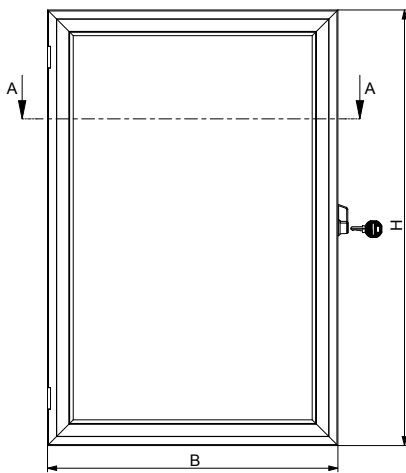

Other Accessories - Earthing Accessories

Fixing lugs for earthing strip

10

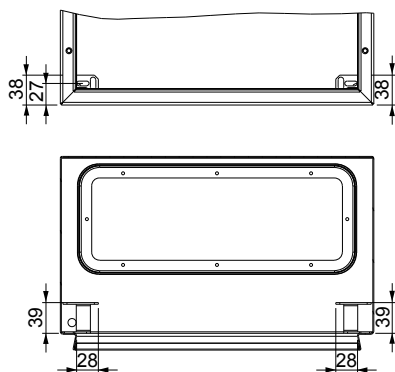

Applicative Solutions



11

Contents

Outdoor Heavy-Duty enclosures	324
Thalassa PLM Landscape	338
Seismic and nuclear enclosures	340
Electronic applications	358
Steel enclosures with protection against electromagnetic interference (EMC)	378
Enclosures for explosive atmospheres (ATEX)	386
Human-Machine Interface Control enclosure, PC racks and control desks	394
Variable-speed drive flush-mounting kits	432
Automotive applications	436

Thalassa PHD is suitable for outdoor public areas thanks to its multiple virtues:

- pressure and shock resistant (IEC 61439-5: 2010),
- anti-posting thanks to its special ribbed-surface door,
- insulated (ready to be Class II according to IEC 61439-1: 2011).



Tough

- PHD: Heavy-Duty polyester reinforced with a double layer of fiberglass. Ultra-resistant, anti-vandalism.



Upper airing module

- The newly engineered roof airing accessory
- Helps to prevent creation of condensation (one of the causes of corrosion).

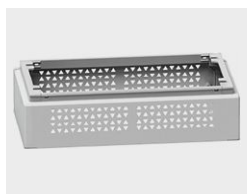

Heavy-Duty accessories

- Dedicated accessories to resist harsh outdoor environments.



Anti-vandalism

- PHD and SFHD: The handle with keylock and additional padlock hole (padlock not included)
- Protects the equipment inside.
- It is standard equipment.



Simplicity

- Installation simplified: Easy lifting even when loaded with up to 1000 (2204.62) kg (lbs.) of equipment. HD lifting accessories also available.



Fully equipped

- Standard, pre-installed equipment includes:
- A curved canopy to avoid water stagnation
 - A door retainer to keep the door open even with strong wind or when a vehicle passes by
 - An aluminum cable gland plate to easily drill holes and avoid corrosion
 - A document pocket to hold your documents in a practical place.

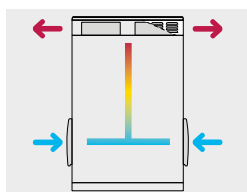

Thermal management solutions

- 3 airing architectures help protecting the equipment installed inside from overheating and humidity.

For details consult our web site www.se.com



Prolonged exposure to UV radiation, wind and rain can cause aesthetics changes in the external surface of the enclosure. Without affecting the technical properties according to IEC 62208. For long exposure applications, it is recommended to use painted enclosures available through the P&S offer.



Polyester outdoor Heavy-Duty enclosures



Steel outdoor Heavy-Duty enclosures

Characteristics	Polyester outdoor Heavy-Duty enclosures		Steel outdoor Heavy-Duty enclosures	
	Wall-mounted enclosure	Floor-standing enclosure	Wall-mounted enclosure	Floor-standing enclosure
	Outdoor Heavy-Duty (HD) enclosures made of polyester insulated material. Suitable to be installed in public areas thanks to its features: <ul style="list-style-type: none"> • Pressure and shock-resistant • Posting-deterrent • Insulated. 		Outdoor Heavy-Duty (HD) enclosures made of coated steel. Suitable to be installed in private areas with harsh environments thanks to its capacity to resist: <ul style="list-style-type: none"> • Corrosion (up to C4H level according ISO 12944:2018) • UV. 	
Material	HD Polyester reinforced with fiberglass to meet standard EN 439-5		HD steel with anti-corrosive coating	
Finish	-		Structured finish, 100% polyester powder	
Color	RAL 7035 grey		RAL 7035 grey	
Conditions of use	Outdoor and/or harsh environments		Outdoor and/or harsh environments	
Temperature range	-40°C (-40°F)...80°C (176°F)		-40°C (-40°F)...80°C (176°F)	
Ingress protection rating	IP65 according to IEC 60529	IP55 according to IEC 60529	IP66 according to IEC 60529	IP55 according to IEC 60529
Mechanical protection rating	IK10 according to IEC 62262		IK10 according to IEC 62262	
Standards	IEC 61439-5: 2010, IEC 62208: 2011, IEC 61439-1: 2011, IEC 61969-3: 2011, IEC 60297-3-100: 2009		IEC 61439-5: 2010, IEC 62208: 2011, IEC 61969-3: 2011, IEC 60297-3-100: 2009, ISO 12.944: 2018 (C4H)	
Certifications	See table page 336		See table page 336	
Fixing	On wall by means of optional wall fixing accessory	2 options for installation on floor: <ul style="list-style-type: none"> • With floor fixing kit NSYMF2PLAZ4 or NSYMF2PLAZ6 for integrated plinth (50 (1.97) mm (in.)) • With additional ZZ plinths (ventilated or non-ventilated) available as accessory • (200 (7.87) mm (in.)) (see page 327) 	<ul style="list-style-type: none"> • On wall by means of optional stainless-steel wall fixing lugs • On post by means of optional HD post fixing device 	<ul style="list-style-type: none"> • Directly on floor by means of optional plinth (see page 331)
Maximum load according to IEC 62208	500 (1102.31) kg (lbs.)		200 (440.92) kg (lbs.)	1000 (2204.62) kg (lbs.)
Other characteristics	<ul style="list-style-type: none"> • Fire resistant (EN 1794-2:2011) • Lifting possible from top with eyebolt accessory • New dedicated airing solutions to be integrated in roof, lateral or plinth. 3 airing architectures proposed (see page 334 and 335) 		New dedicated airing solutions to be integrated in roof, side or plinth	
Options Supply	Plain door or ribbed door	<ul style="list-style-type: none"> • Curved canopy • Integrated plinth • Handle with keylock (1242E type) and padlock • Aluminum cable gland plate • Door retainer • Plastic document pocket (A4 size) 	<ul style="list-style-type: none"> • Curved canopy • 3 (0.12) mm (in.) double-bar lock • Plastic document pocket (A4 size) • Door retainer • Aluminum cable gland plate 	<ul style="list-style-type: none"> • Curved canopy • Rear panel • Handle with keylock (1242E type) and padlock • Aluminum cable gland plate • Door retainer • Plastic document pocket (A4 size)

Polyester outdoor Heavy-Duty enclosures

- Outdoor Heavy-Duty (HD) enclosures made of polyester insulated material. Suitable to be installed in public areas thanks to its features: pressure and shock-resistant, posting-deterrent, insulated.
 - Material: HD Polyester reinforced with fiberglass to meet standard EN 439-5
 - Color: RAL 7035 grey
 - Conditions of use: Outdoor and/or harsh environments
 - Temperature range: -40°C (-40°F)...80°C (176°F)
 - Mechanical protection rating: IK10 according to IEC 62262
 - Standards: IEC 61439-5: 2010, IEC 62208: 2011, IEC 61439-1: 2011, IEC 61969-3: 2011, IEC 60297-3-100: 2009
- Certifications: See table [page 336](#)
- Maximum load according to IEC 62208: 500 (1102.31) kg (lbs.)
 - Other characteristics: Fire resistant (EN 1794-2:2011), Lifting possible from top with eyebolt accessory, new dedicated airing solutions to be integrated in roof, lateral or plinth.
3 airing architectures proposed (see [page 334](#) and [335](#))
 - Options: Plain door or ribbed door

Wall-mounted enclosure



NSYPHDT553

- Ingress protection rating: IP65 according to IEC 60529
- Fixing: On wall by means of optional wall fixing accessory

Supply:

- Curved canopy
- Handle with keylock (1242E type) and padlock
- Door retainer
- Plastic document pocket (A4 size)

Characteristics	Door type	No. of doors	Dimensions (H x W x D) mm (in.)	References
Wall-mounted enclosure	Anti-posting	1	538 (21.18) x 500 (19.68) x 320 (12.60)	NSYPHDT553
Wall-mounted enclosure	Anti-posting	1	788 (31.02) x 500 (19.68) x 320 (12.60)	NSYPHDT753
Wall-mounted enclosure	Plain	1	538 (21.18) x 500 (19.68) x 320 (12.60)	NSYPHDT553P
Wall-mounted enclosure	Plain	1	788 (31.02) x 500 (19.68) x 320 (12.60)	NSYPHDT753P

Floor-standing enclosure



NSYPHDZT774

- Ingress protection rating: IP55 according to IEC 60529
- Fixing: 2 options for installation on floor:
- With floor fixing kit **NSYMF2PLAZ4** or **NSYMF2PLAZ6** for integrated plinth (50 (1.97) mm (in.))
- With additional ZZ plinths (ventilated or non-ventilated) available as accessory (200 (7.87) mm (in.)) (see [page 327](#))

Supply:

- Curved canopy
- Integrated plinth
- Handle with keylock (1242E type) and padlock
- Aluminum cable gland plate
- Door retainer
- Plastic document pocket (A4 size)

Characteristics	Door type	No. of doors	Dimensions (H x W x D) mm (in.)	References
Floor-standing enclosure	Anti-posting	1	843 (33.19) x 750 (29.53) x 420 (16.54)	NSYPHDZT774
Floor-standing enclosure	Anti-posting	1	843 (33.19) x 750 (29.53) x 620 (24.41)	NSYPHDZT776
Floor-standing enclosure	Anti-posting	1	1093 (43.03) x 500 (19.68) x 420 (16.54)	NSYPHDZT1054
Floor-standing enclosure	Anti-posting	1	1093 (43.03) x 750 (29.53) x 420 (16.54)	NSYPHDZT1074
Floor-standing enclosure	Anti-posting	1	1343 (52.87) x 500 (19.68) x 420 (16.54)	NSYPHDZT1254
Floor-standing enclosure	Anti-posting	1	1343 (52.87) x 750 (29.53) x 420 (16.54)	NSYPHDZT1274
Floor-standing enclosure	Anti-posting	1	1343 (52.87) x 750 (29.53) x 620 (24.41)	NSYPHDZT1276
Floor-standing enclosure	Anti-posting	2	1343 (52.87) x 1250 (49.21) x 420 (16.54)	NSYPHDZT12124
Floor-standing enclosure	Anti-posting	2	1343 (52.87) x 1250 (49.21) x 620 (24.41)	NSYPHDZT12126
Floor-standing enclosure	Anti-posting	1	1593 (62.72) x 750 (29.53) x 420 (16.54)	NSYPHDZT1574
Floor-standing enclosure	Anti-posting	1	1593 (62.72) x 750 (29.53) x 620 (24.41)	NSYPHDZT1576
Floor-standing enclosure	Anti-posting	2	1593 (62.72) x 1250 (49.21) x 420 (16.54)	NSYPHDZT15124
Floor-standing enclosure	Anti-posting	2	1593 (62.72) x 1250 (49.21) x 620 (24.41)	NSYPHDZT15126
Floor-standing enclosure	Anti-posting	2 Vertical	2093 (82.40) x 750 (29.53) x 420 (16.54)	NSYPHDZT2074
Floor-standing enclosure	Plain	1	843 (33.19) x 750 (29.53) x 420 (16.54)	NSYPHDZT774P
Floor-standing enclosure	Plain	1	843 (33.19) x 750 (29.53) x 620 (24.41)	NSYPHDZT776P
Floor-standing enclosure	Plain	1	1093 (43.03) x 500 (19.68) x 420 (16.54)	NSYPHDZT1054P
Floor-standing enclosure	Plain	1	1093 (43.03) x 750 (29.53) x 420 (16.54)	NSYPHDZT1074P
Floor-standing enclosure	Plain	1	1343 (52.87) x 500 (19.68) x 420 (16.54)	NSYPHDZT1254P
Floor-standing enclosure	Plain	1	1343 (52.87) x 750 (29.53) x 420 (16.54)	NSYPHDZT1274P
Floor-standing enclosure	Plain	1	1343 (52.87) x 750 (29.53) x 620 (24.41)	NSYPHDZT1276P
Floor-standing enclosure	Plain	2	1343 (52.87) x 1250 (49.21) x 420 (16.54)	NSYPHDZT12124P
Floor-standing enclosure	Plain	2	1343 (52.87) x 1250 (49.21) x 620 (24.41)	NSYPHDZT12126P
Floor-standing enclosure	Plain	1	1593 (62.72) x 750 (29.53) x 420 (16.54)	NSYPHDZT1574P
Floor-standing enclosure	Plain	1	1593 (62.72) x 750 (29.53) x 620 (24.41)	NSYPHDZT1576P
Floor-standing enclosure	Plain	2	1593 (62.72) x 1250 (49.21) x 420 (16.54)	NSYPHDZT15124P
Floor-standing enclosure	Plain	2	1593 (62.72) x 1250 (49.21) x 620 (24.41)	NSYPHDZT15126P
Floor-standing enclosure	Plain	2 Vertical	2093 (82.40) x 750 (29.53) x 420 (16.54)	NSYPHDZT2074P



NSYPHDZT774P

Eyebolts



NSYPLHD

- Top lifting accessory for polyester outdoor Heavy-Duty enclosure.
- Maximum load per enclosure: 500 (1102.31) kg (lbs.)
- Material: Galvanized cast steel

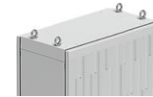

Supply:
4

Characteristics	References
Eyebolts	NSYPLHD

Wall fixing accessory



NSYFMPHD

- Wall fixing support for polyester outdoor Heavy-Duty enclosure.
- No change in ingress protection rate.
- Maximum load per enclosure: 180 (396.83) kg (lbs.)
- Material: Zinc-coated steel
- Finish: Zinc coating



Supply:
6

Characteristics	References
Wall fixing accessory	NSYFMPHD

Floor fixing kit



NSYMF2PLAZ4

- To fix the enclosure on the floor without a plinth.
- Material: Steel
- Finish: Insulated coating
- Installation: On dry concrete



Supply:
1

Characteristics	Depth mm (in.)	References
Floor fixing kit	420 (16.54)	NSYMF2PLAZ4
Floor fixing kit	620 (24.41)	NSYMF2PLAZ6

Ventilated ZZ plinth 200 (7.87) mm (in.)

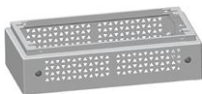

NSYZZ254VHD

- Height: 200 (7.87) mm (in.)
- The front part can be removed with a 1242 key.
- Includes a polyester anti-insect filter.
- Material: Glass-reinforced polyester
- Color: RAL 7035 grey



Note:

The coupling kit **NSYMUPLA●●●** is not applicable for enclosures using ZZ or ZH type plinths.

Supply:
1

Characteristics	Dimensions (W x D) mm (in.)	References
Ventilated ZZ plinth 200 (7.87) mm (in.)	500 (19.68) x 420 (16.54)	NSYZZ254VHD
Ventilated ZZ plinth 200 (7.87) mm (in.)	750 (29.53) x 420 (16.54)	NSYZZ274VHD
Ventilated ZZ plinth 200 (7.87) mm (in.)	750 (29.53) x 620 (24.41)	NSYZZ276VHD
Ventilated ZZ plinth 200 (7.87) mm (in.)	1250 (49.21) x 420 (16.54)	NSYZZ2124VHD
Ventilated ZZ plinth 200 (7.87) mm (in.)	1250 (49.21) x 620 (24.41)	NSYZZ2126VHD

ZZ plinth 200 (7.87) mm (in.)



NSYZZ254G

- Height: 200 (7.87) mm (in.)
- The front and back plates can only be removed from the inside.
- It is provided with one or two reinforcement cross-rails, adjustable to adapt to the position of the cables.
- Material: Glass-reinforced polyester
- Color: RAL 7035 grey



Note:

The coupling kit **NSYMUPLA●●●** is not applicable for enclosures using ZZ or ZH type plinths.

Supply:
1

Characteristics	Dimensions (W x D) mm (in.)	References
ZZ plinth 200 (7.87) mm (in.)	500 (19.68) x 420 (16.54)	NSYZZ254G
ZZ plinth 200 (7.87) mm (in.)	750 (29.53) x 420 (16.54)	NSYZZ274G
ZZ plinth 200 (7.87) mm (in.)	750 (29.53) x 620 (24.41)	NSYZZ276G
ZZ plinth 200 (7.87) mm (in.)	1250 (49.21) x 420 (16.54)	NSYZZ2124G
ZZ plinth 200 (7.87) mm (in.)	1250 (49.21) x 620 (24.41)	NSYZZ2126G

Plain mounting plate

- The enclosures with height of ≥ 1000 (39.37) mm (in.) have intermediate bosses to fix the mounting plate (M8 inserts, ref. **NSYTEX8**, to be ordered separately).
 - Material: Galvanized steel
- Installation:**
- Direct installation on M8 inserts at the rear of the enclosure or on step slides for depth adjustment (see [page 230](#))
 - In the double-door enclosures, it is possible to install 1 complete mounting plate or 2 individual mounting plates

Supply:
1



NSYPMM55

Characteristics	Dimensions (H x W) mm (in.)	References
Plain mounting plate	538 (21.18) x 500 (19.68)	NSYPMM55
Plain mounting plate	788 (31.02) x 500 (19.68)	NSYPMM75
Plain mounting plate	843 (33.19) x 750 (29.53)	NSYPMM77
Plain mounting plate	1093 (43.03) x 500 (19.68)	NSYPMM105
Plain mounting plate	1093 (43.03) x 750 (29.53)	NSYPMM107
Plain mounting plate	1343 (52.87) x 500 (19.68)	NSYPMM125
Plain mounting plate	1343 (52.87) x 750 (29.53)	NSYPMM127
Plain mounting plate	1343 (52.87) x 1250 (49.21)	NSYPMM1212
Plain mounting plate	1583 (62.32) x 750 (29.53)	NSYPMM157
Plain mounting plate	1583 (62.32) x 1250 (49.21)	NSYPMM1512
Plain mounting plate (or 2 x NSYPMM107)	2093 (82.40) x 750 (29.53)	NSYPMM207

Roof airing module

- Airing module to enable airing from the top of the enclosure (H = 95 (3.74) mm (in.)).
- Material: Steel with anti-corrosive coating (C4H according ISO 12.944: 2018)
- Finish: Structured finish, 100% polyester powder
- Color: RAL 7035 grey



Supply:
1



NSYPCVR54HD

Characteristics	Dimensions (W x D) mm (in.)	References
Roof airing module	500 (19.68) x 420 (16.54)	NSYPCVR54HD
Roof airing module	750 (29.53) x 420 (16.54)	NSYPCVR74HD
Roof airing module	750 (29.53) x 620 (24.41)	NSYPCVR76HD
Roof airing module	1250 (49.21) x 420 (16.54)	NSYPCVR124HD
Roof airing module	1250 (49.21) x 620 (24.41)	NSYPCVR126HD

Anti burglary accessory

- Anti burglary accessory for polyester outdoor Heavy-Duty in accordance with ENV 1627-1630:2011 class 2.
- It keeps the Insulation Class II according to IEC 61439-1:2011.
- Material: Steel with anti-corrosive coating (C4H according ISO 12.944: 2018)
- Finish: Structured finish, 100% polyester powder
- Color: RAL 7035 grey
- Installation: Easy installation on the outside of the enclosure



Supply:
1



NSYBGN774HD

Characteristics	Dimensions (H x W x D) mm (in.)	References
Anti burglary accessory	843 (33.19) x 750 (29.53) x 420 (16.54)	NSYBGN774HD
Anti burglary accessory	843 (33.19) x 750 (29.53) x 620 (24.41)	NSYBGN776HD
Anti burglary accessory	1093 (43.03) x 500 (19.68) x 420 (16.54)	NSYBGN1054HD
Anti burglary accessory	1093 (43.03) x 750 (29.53) x 420 (16.54)	NSYBGN1074HD
Anti burglary accessory	1343 (52.87) x 500 (19.68) x 420 (16.54)	NSYBGN1254HD
Anti burglary accessory	1343 (52.87) x 750 (29.53) x 420 (16.54)	NSYBGN1274HD
Anti burglary accessory	1343 (52.87) x 750 (29.53) x 620 (24.41)	NSYBGN1276HD
Anti burglary accessory	1343 (52.87) x 1250 (49.21) x 420 (16.54)	NSYBGN12124HD
Anti burglary accessory	1343 (52.87) x 1250 (49.21) x 620 (24.41)	NSYBGN12126HD
Anti burglary accessory	1593 (62.72) x 750 (29.53) x 420 (16.54)	NSYBGN1574HD
Anti burglary accessory	1593 (62.72) x 750 (29.53) x 620 (24.41)	NSYBGN1576HD
Anti burglary accessory	1593 (62.72) x 1250 (49.21) x 420 (16.54)	NSYBGN15124HD
Anti burglary accessory	1593 (62.72) x 1250 (49.21) x 620 (24.41)	NSYBGN15126HD
Anti burglary accessory	2093 (82.40) x 750 (29.53) x 420 (16.54)	NSYBGN2074HD

Steel outdoor HD enclosures

- Outdoor Heavy-Duty (HD) enclosures made of coated steel.
- Suitable to be installed in private areas with harsh environments thanks to its capacity to resist: corrosion (up to C4H level according to ISO 12944:2018), UV
- Material: HD steel with anti-corrosive coating
- Finish: Structured finish, 100% polyester powder
- Color: RAL 7035 grey
- Conditions of use: Outdoor and/or harsh environments
- Temperature range: -40°C (-40°F) ... 80°C (176°F)
- Mechanical protection rating: IK10 according to IEC 62262
- Standards: IEC 61439-5: 2010, IEC 62208: 2011, IEC 61969-3: 2011, IEC 60297-3-100: 2009, ISO 12.944: 2018 (C4H)
- Certifications: See table [page 336](#)
- Other characteristics: New dedicated airing solutions to be integrated in roof, side or plinth

Supply:
 Curved canopy
 Plastic document pocket (A4 size)
 Door retainer
 Aluminum cable gland plate

Wall-mounted enclosure

- Ingress protection rating: IP66 according to IEC 60529
- Fixing: On wall by means of optional stainless-steel wall fixing lugs, on post by means of optional HD post fixing device
- Maximum load according to IEC 62208: 200 (440.92) kg (lbs.)
- cUL according to 508A CSA C.22.2 N° 14 .
- Environmental rating according to UL50E 4, 4x and 13

Supply:
 3 (0.12) mm (in.) double-bar lock



NSYS3HD3215

Characteristics	Dimensions (H x W x D) mm (in.)	References
Wall-mounted enclosure	343 (13.50) x 200 (7.87) x 180 (7.09)	NSYS3HD3215
Wall-mounted enclosure	448 (17.64) x 300 (11.81) x 230 (9.06)	NSYS3HD4320
Wall-mounted enclosure	548 (21.58) x 400 (15.75) x 230 (9.06)	NSYS3HD5420
Wall-mounted enclosure	653 (25.71) x 400 (15.75) x 280 (11.02)	NSYS3HD6425
Wall-mounted enclosure	658 (25.91) x 600 (23.62) x 330 (12.99)	NSYS3HD6630
Wall-mounted enclosure	753 (29.65) x 500 (19.68) x 280 (11.02)	NSYS3HD7525
Wall-mounted enclosure	858 (33.78) x 600 (23.62) x 330 (12.99)	NSYS3HD8630
Wall-mounted enclosure	862 (33.94) x 800 (31.50) x 430 (16.93)	NSYS3HD8840
Wall-mounted enclosure	1062 (41.81) x 600 (23.62) x 430 (16.93)	NSYS3HD10640
Wall-mounted enclosure	1062 (41.81) x 800 (31.50) x 430 (16.93)	NSYS3HD10840

Floor-standing enclosure

- Ingress protection rating: IP55 according to IEC 60529
- Fixing: Directly on floor by means of optional plinth
- Maximum load according to IEC 62208: 1000 (2204.62) kg (lbs.)
- Coupling only possible on demand
- cUL according to UL508a.
- Environmental ratings according to UL50E,12 and 3R

Supply:
 Rear panel
 Handle with keylock (1242E type) and padlock



NSYSFHD12640

Characteristics	Dimensions (H x W x D) mm (in.)	References
Floor-standing enclosure	1262 (49.68) x 600 (23.62) x 430 (16.93)	NSYSFHD12640
Floor-standing enclosure	1262 (49.68) x 800 (31.50) x 430 (16.93)	NSYSFHD12840
Floor-standing enclosure	1262 (49.68) x 1200 (47.24) x 430 (16.93)	NSYSFHD1212402D
Floor-standing enclosure	1281 (50.43) x 600 (23.62) x 630 (24.80)	NSYSFHD12660
Floor-standing enclosure	1281 (50.43) x 800 (31.50) x 630 (24.80)	NSYSFHD12860
Floor-standing enclosure	1281 (50.43) x 1200 (47.24) x 630 (24.80)	NSYSFHD1212602D
Floor-standing enclosure	1662 (65.43) x 800 (31.50) x 430 (16.93)	NSYSFHD16840
Floor-standing enclosure	1662 (65.43) x 1200 (47.24) x 430 (16.93)	NSYSFHD1612402D
Floor-standing enclosure	1681 (66.18) x 600 (23.62) x 630 (24.80)	NSYSFHD16660
Floor-standing enclosure	1681 (66.18) x 800 (31.50) x 630 (24.80)	NSYSFHD16860
Floor-standing enclosure	1681 (66.18) x 1200 (47.24) x 630 (24.80)	NSYSFHD1612602D
Floor-standing enclosure	2062 (81.18) x 800 (31.50) x 430 (16.93)	NSYSFHD20840

Side panels for floor-standing enclosures

- Side panel fixing for SFHD.
- Material: Steel with anti-corrosive coating (C4H according ISO 12.944: 2018)
- Finish: Structured finish, 100% polyester powder
- Color: RAL 7035 grey

Supply:
2 side panels with fixing elements and sealing gasket



NSY2SPHD124

Characteristics	Dimensions (H x D) mm (in.)	References
Side panels, external fixing	1262 (49.68) x 430 (16.93)	NSY2SPHD124
Side panels, external fixing	1281 (50.43) x 630 (24.80)	NSY2SPHD126
Side panels, external fixing	1662 (65.43) x 430 (16.93)	NSY2SPHD164
Side panels, external fixing	1681 (66.18) x 630 (24.80)	NSY2SPHD166
Side panels, external fixing	2060 (81.10) x 430 (16.93)	NSY2SPHD204
Side panels, internal fixing	1262 (49.68) x 430 (16.93)	NSY2SPIHD124
Side panels, internal fixing	1281 (50.43) x 630 (24.80)	NSY2SPIHD126
Side panels, internal fixing	1662 (65.43) x 430 (16.93)	NSY2SPIHD164
Side panels, internal fixing	1681 (66.18) x 630 (24.80)	NSY2SPIHD166
Side panels, internal fixing	2060 (81.10) x 430 (16.93)	NSY2SPIHD204

Stainless-steel wall fixing lugs

- Set of 4 wall fixing lugs.
- Mounted directly on the rear of the enclosure, either in horizontal or vertical position.
- Wall-enclosure separation of 12 (0.47) mm (in.)
- Do not use for dynamic loads.
- Maximum load: 250 (551.16) kg (lbs.)



NSYAEFFFXSC

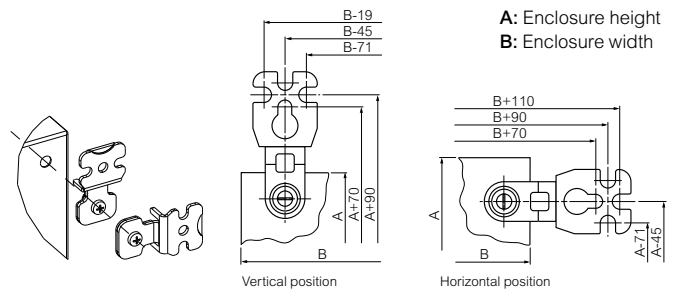

Supply:
Supplied with fixing screws and pre-mounted sealing gaskets

Characteristics	References
Wall fixing lugs, 304L stainless-steel	NSYAEFFFXSC

Heavy-Duty padlockable double lock, for wall-mounted enclosures

- Easy mounting instead of the standard lock.
- Material: Zamak
- Finish: Anti-corrosive coating

Supply:
Delivered with 3 (0.12) mm (in.) double-bar metal key



NSYAEPLPADS3DHD

Characteristics	References
Heavy-Duty padlockable double lock	NSYAEPLPADS3DHD

Stainless-steel plinths 200 (7.87) mm (in.)

- Material: Stainless-steel AISI 304L
- Finish: Scotch-Brite® brushing

Installation: For wall-mounted enclosure: It is necessary to order separately the plinth fixing kit (ref. **NSYAPFXWM**) composed by fixing hardware and drilling template, for floor-standing enclosure: Mounting in the holes for fixing the enclosures to the floor

Ventilated plinths, front and rear kit



NSYSFVX6200

- The front and rear of the plinth consists of 4 corners with 2 panels.

Supply:
1 kit

Characteristics	Width mm (in.)	References
Ventilated plinths, front and rear kit	600 (23.62)	NSYSFVX6200
Ventilated plinths, front and rear kit	800 (31.50)	NSYSFVX8200
Ventilated plinths, front and rear kit	1200 (47.24)	NSYSFVX12200

Ventilated plinths, lateral kit



NSYSPLVX4200SF

- They are fixed to the corner of the plinth by fixing screws.

Supply:
1 kit

Characteristics	Depth mm (in.)	References
Ventilated plinths, for wall-mounted enclosure	330 (12.99)	NSYSPLVX3200
Ventilated plinths, for wall-mounted enclosure	430 (16.93)	NSYSPLVX4200
Ventilated plinths, for floor-standing enclosure	430 (16.93)	NSYSPLVX4200SF
Ventilated plinths, for floor-standing enclosure	630 (24.80)	NSYSPLVX6200SF

Standard plinths, front and rear kit



NSYSFVX6200

- The front and rear of the plinth consists of 4 corners with 2 panels.

Supply:
1 kit

Characteristics	Width mm (in.)	References
Plinth height 200 (7.87) mm (in.), Kit (4 corners + front and back), AISI 304L	600 (23.62)	NSYSFVX6200
Plinth height 200 (7.87) mm (in.), Kit (4 corners + front and back), AISI 304L	800 (31.50)	NSYSFVX8200
Plinth height 200 (7.87) mm (in.), Kit (4 corners + front and back), AISI 304L	1200 (47.24)	NSYSFVX12200

Standard plinths, lateral kit



NSYSPSX3200

- They are fixed to the corner of the plinth by fixing screws.

Supply:
1 kit

Characteristics	Depth mm (in.)	References
Standard plinths height 200 (7.87) mm (in.), for wall-mounted enclosure, AISI 304L	330 (12.99)	NSYSPSX3200
Standard plinths height 200 (7.87) mm (in.), for wall-mounted enclosure, AISI 304L	430 (16.93)	NSYSPSX4200
Standard plinths height 200 (7.87) mm (in.), for floor-standing enclosure, AISI 304L	430 (16.93)	NSYSPSX4200SF
Standard plinths height 200 (7.87) mm (in.), for floor-standing enclosure, AISI 304L	630 (24.80)	NSYSPSX6200SF

Plain mounting plate



- Material: Galvanized steel

Supply:
1 mounting plate and fixing elements

Characteristics	Dimensions (H x W) mm (in.)	References
Plain mounting plate, for wall-mounted enclosure	300 (11.81) x 200 (7.87)	NSYMM32
Plain mounting plate, for wall-mounted enclosure	500 (19.68) x 400 (15.75)	NSYMM54
Plain mounting plate, for wall-mounted enclosure	600 (23.62) x 400 (15.75)	NSYMM64
Plain mounting plate, for wall-mounted enclosure	600 (23.62) x 600 (23.62)	NSYMM66
Plain mounting plate, for wall-mounted enclosure	700 (27.56) x 500 (19.68)	NSYMM75
Plain mounting plate, for wall-mounted enclosure ⁽¹⁾	800 (31.50) x 600 (23.62)	NSYMM86
Plain mounting plate, for wall-mounted enclosure	800 (31.50) x 800 (31.50)	NSYMM88
Plain mounting plate, for wall-mounted enclosure	1000 (39.37) x 600 (23.62)	NSYMM106
Plain mounting plate, for wall-mounted enclosure ⁽¹⁾	1000 (39.37) x 800 (31.50)	NSYMM108
Plain mounting plate, for floor-standing enclosure	1200 (47.24) x 600 (23.62)	NSYMP126
Plain mounting plate, for floor-standing enclosure	1200 (47.24) x 800 (31.50)	NSYMP128
Plain mounting plate, for floor-standing enclosure	1200 (47.24) x 1200 (47.24)	NSYMP1212
Plain mounting plate, for floor-standing enclosure	1600 (62.99) x 600 (23.62)	NSYMP168
Plain mounting plate, for floor-standing enclosure	1600 (62.99) x 800 (31.50)	NSYMP1612
Plain mounting plate, for floor-standing enclosure	1600 (62.99) x 1200 (47.24)	NSYMP166
Plain mounting plate, for floor-standing enclosure	2000 (78.74) x 800 (31.50)	NSYMP208

Roof airing module

- Airing module to enable airing from the top of the enclosure (H = 95 (3.74) mm (in.)).
- Material: Steel with anticorrosive coating
- Finish: Structured finish, 100% polyester powder
- Color: RAL 7035 grey

Supply:
1



Characteristics	For enclosure dimensions (W x D) mm (in.)	References
Roof airing module, for wall-mounted enclosure	600 (23.62) x 430 (16.93)	NSYS3CVR64HD
Roof airing module, for wall-mounted enclosure	800 (31.50) x 430 (16.93)	NSYS3CVR84HD
Roof airing module, for floor-standing enclosure	600 (23.62) x 430 (16.93)	NSYSFCVR64HD
Roof airing module, for floor-standing enclosure	600 (23.62) x 630 (24.80)	NSYSFCVR66HD
Roof airing module, for floor-standing enclosure	800 (31.50) x 430 (16.93)	NSYSFCVR84HD
Roof airing module, for floor-standing enclosure	800 (31.50) x 630 (24.80)	NSYSFCVR86HD
Roof airing module, for floor-standing enclosure	1200 (47.24) x 430 (16.93)	NSYSFCVR124HD
Roof airing module, for floor-standing enclosure	1200 (47.24) x 630 (24.80)	NSYSFCVR126HD

Airing system Heavy-Duty

Fanbox



NSYCVF550M24FB

- Free flow rate: 550 m³/h (323.72 ft³/min) (50/60 Hz).
- Minimal depth inside the enclosure (90 (3.54) mm (in.)).
- Allows multiple cooling architectures (see page 334 and 335).
- Material: Plastic
- Color: RAL 7016 dark grey

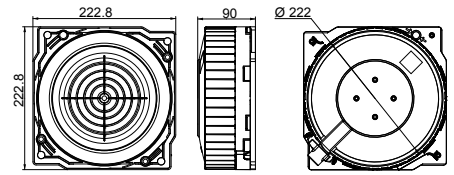

Supply:
1 (grille not included)

Characteristics	Voltage	References
Fanbox	24 V DC	NSYCVF550M24FB
Fanbox	115 V AC	NSYCVF550M115FB
Fanbox	230 V AC	NSYCVF550M230FB

Filter



NSYCAF223T

- Replacement G3 M1 type synthetic filter for HD metal grille.
- Dimensions: 215 (8.46) x 215 (8.46) mm (in.).
- Material: 100% polyester fibers
- Color: White

Supply:
5

Characteristics	Height mm (in.)	Width mm (in.)	Depth mm (in.)	Cut-out mm (in.)	References
G3 M1 synthetic fine filters	268 (10.55)	248 (9.76)	18 (0.71)	223 (8.78) x 223 (8.78)	NSYCAF223T

Roof filter for fanbox



NSYCAF190

- Roof G2 round synthetic filter designed to cover the fanbox. Covers completely the fanbox and helps to protect it from dust and humidity. Mandatory for fanbox installation in the roof airing module for IP55 configurations.
- Material: 100% polyester fibers
- Color: White

Supply:
1

Characteristics	References
Roof filter for fanbox	NSYCAF190

IP55 HD Metal Grille



NSYCAAG223LFHD

- Slim grille (35 (1.38) mm (in.) external depth).
- Includes a G3 M1
- Material: Steel with anti-corrosive coating + plastic PA6 / GF25 for fixing frame
- Finish: Structured finish, 100% polyester powder
- Color: RAL 7035 grey
- Ingress protection rating: IP55 according to IEC 60529
- Mechanical protection rating: IK10 according to IEC 62262

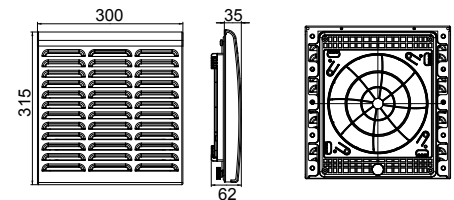

Supply:
1 grille delivered with G3 M1 type synthetic filter (215 (8.46) x 215 (8.46) mm (in.)) and fixings

Characteristics	References
IP55 HD Metal Grille	NSYCAAG223LFHD

Anti-vandalism kit for HD metal grille



NSYCAAPVHD

- Fixings that help to prevent to open the grille from the outside with standard tools (EN 1627-1630:2011 Class 2).
- Quick installation without tools.
- Material: Steel with anticorrosive coating + plastic for fixing screws

Note:
not compatible with NSYSPLA150

Supply:
4 grip knob
4 clip nuts

Characteristics	References
Anti-vandalism kit for HD metal grille	NSYCAAPVHD

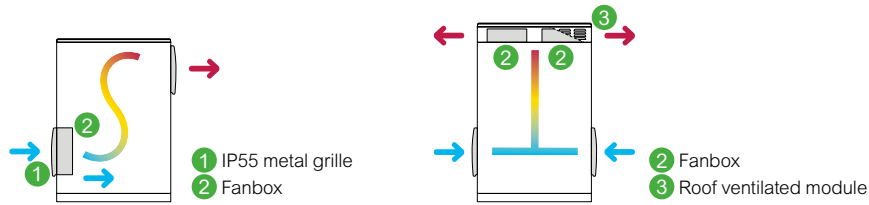

	S-Line				T-Line				
Architecture benefits	<ul style="list-style-type: none"> • Most common and competitive architecture • Maximum heat dissipation to extract 800 W-1000 W • ΔT° of 5°C (41°F) • Easy access to mount-dismount fanbox • Air flow in horizontal axis 				<ul style="list-style-type: none"> • High thermal extraction capacity up to 1500 W • Noise level with 1 fan: 55 dB when installed inside the upper airing module • ΔT° of 5°C (41°F) • Air flow in vertical axis 				
	IP55 metal grille		Fanbox		IP55 metal grille		Fanbox (1 filter NSYCAF190 for each Fanbox)		Roof airing module
	Door	Side	Door	Side	Door	Side			

Polyester outdoor HD enclosure

References	Amount to be installed				Amount to be installed				References
NSYPHDT553	-	-	-	-	-	-	-	-	-
NSYPHDT553P	-	-	-	-	-	-	-	-	-
NSYPHDT753	-	-	-	-	-	-	-	-	-
NSYPHDT753P	1 to 2	-	1 to 2	-	1 to 2	-	-	-	-
NSYPHDT774	-	1 to 2	-	1 to 2	-	1 to 2	1 to 2	1	NSYPCVR74HD
NSYPHDT774P	1 to 2	1 to 2	1 to 2	1 to 2	1 to 2	1 to 2	1 to 2	1	NSYPCVR74HD
NSYPHDT776	-	1 to 2	-	1 to 2	-	1 to 2	1 to 2	1	NSYPCVR76HD
NSYPHDT776P	1 to 2	1 to 2	1 to 2	1 to 2	1 to 2	1 to 2	1 to 2	1	NSYPCVR76HD
NSYPHDT1054	-	1	-	1	-	1	1	1	NSYPCVR54HD
NSYPHDT1054P	1 to 2	1	1 to 2	1	1 to 2	1	1	1	NSYPCVR54HD
NSYPHDT1074	-	1 to 2	-	1 to 2	-	1 to 2	1 to 2	1	NSYPCVR74HD
NSYPHDT1074P	1 to 4	1 to 2	1 to 4	1 to 2	1 to 4	1 to 2	1 to 2	1	NSYPCVR74HD
NSYPHDT12124	-	1 to 3	-	1 to 3	-	1 to 3	1 to 3	1	NSYPCVR124HD
NSYPHDT12124P	1 to 4	1 to 3	1 to 4	1 to 3	1 to 4	1 to 3	1 to 3	1	NSYPCVR124HD
NSYPHDT12126	-	1 to 3	-	1 to 3	-	1 to 3	1 to 3	1	NSYPCVR126HD
NSYPHDT12126P	1 to 4	1 to 3	1 to 4	1 to 3	1 to 4	1 to 3	1 to 3	1	NSYPCVR126HD
NSYPHDT1254	-	1	-	1	-	1	1	1	NSYPCVR54HD
NSYPHDT1254P	1 to 3	1	1 to 3	1	1 to 3	1	1	1	NSYPCVR54HD
NSYPHDT1274	-	1 to 2	-	1 to 2	-	1 to 2	1 to 2	1	NSYPCVR74HD
NSYPHDT1274P	1 to 4	1 to 2	1 to 4	1 to 2	1 to 4	1 to 2	1 to 2	1	NSYPCVR74HD
NSYPHDT1276	-	1 to 2	-	1 to 2	-	1 to 2	1 to 2	1	NSYPCVR76HD
NSYPHDT1276P	1 to 4	1 to 2	1 to 4	1 to 2	1 to 4	1 to 2	1 to 2	1	NSYPCVR76HD
NSYPHDT15124	-	1 to 3	-	1 to 3	-	1 to 3	1 to 3	1	NSYPCVR124HD
NSYPHDT15124P	1 to 4	1 to 3	1 to 4	1 to 3	1 to 4	1 to 3	1 to 3	1	NSYPCVR124HD
NSYPHDT15126	-	1 to 3	-	1 to 3	-	1 to 3	1 to 3	1	NSYPCVR126HD
NSYPHDT15126P	1 to 4	1 to 3	1 to 4	1 to 3	1 to 4	1 to 3	1 to 3	1	NSYPCVR126HD
NSYPHDT1574	-	1 to 2	-	1 to 2	-	1 to 2	1 to 2	1	NSYPCVR74HD
NSYPHDT1574P	1 to 4	1 to 2	1 to 4	1 to 2	1 to 4	1 to 2	1 to 2	1	NSYPCVR74HD
NSYPHDT1576	-	1 to 2	-	1 to 2	-	1 to 2	1 to 2	1	NSYPCVR76HD
NSYPHDT1576P	1 to 4	1 to 2	1 to 4	1 to 2	1 to 4	1 to 2	1 to 2	1	NSYPCVR76HD
NSYPHDT2074	-	1 to 2	-	1 to 2	-	1 to 2	1 to 2	1	NSYPCVR74HD
NSYPHDT2074P	1 to 4	1 to 2	1 to 4	1 to 2	1 to 4	1 to 2	1 to 2	1	NSYPCVR74HD

Steel outdoor HD enclosure

NSYS3HD8630	1 to 2	-	1 to 2	-	1 to 2	-	-	-	-
NSYS3HD8840	1 to 2	1 to 2	1 to 2	1 to 2	1 to 2	1 to 2	1 to 2	1	NSYS3CVR84HD
NSYS3HD10640	1 to 2	1 to 2	1 to 2	1 to 2	1 to 2	1 to 2	1	1	NSYS3CVR64HD
NSYS3HD10840	1 to 4	1 to 2	1 to 4	1 to 2	1 to 4	1 to 2	1 to 2	1	NSYS3CVR84HD
NSYSFHD12640	1 to 3	1 to 3	1 to 3	1 to 3	1 to 3	1 to 3	1	1	NSYSFCVR64HD
NSYSFHD12660	1 to 3	1 to 3	1 to 3	1 to 3	1 to 3	1 to 3	1	1	NSYSFCVR66HD
NSYSFHD12840	1 to 4	1 to 3	1 to 4	1 to 3	1 to 4	1 to 3	1 to 2	1	NSYSFCVR84HD
NSYSFHD12860	1 to 4	1 to 3	1 to 4	1 to 3	1 to 4	1 to 3	1 to 2	1	NSYSFECA66HD
NSYSFHD16660	1 to 4	1 to 4	1 to 4	1 to 4	1 to 4	1 to 4	1	1	NSYSFCVR66HD
NSYSFHD16840	1 to 4	1 to 4	1 to 4	1 to 3	1 to 4	1 to 3	1 to 2	1	NSYSFCVR84HD
NSYSFHD16860	1 to 4	1 to 4	1 to 4	1 to 4	1 to 4	1 to 4	1 to 2	1	NSYSFECA66HD
NSYSFHD20840	1 to 4	1 to 4	1 to 4	1 to 4	1 to 4	1 to 4	1 to 2	1	NSYSFCVR84HD
NSYSFHD1212402D	1 to 4	1 to 3	1 to 4	1 to 2	1 to 4	1 to 2	1 to 3	1	NSYSFCVR124HD
NSYSFHD1212602D	1 to 4	1 to 3	1 to 4	1 to 3	1 to 4	1 to 2	1 to 3	1	NSYSFCVR126HD
NSYSFHD1612402D	1 to 4	1 to 4	1 to 4	1 to 3	1 to 4	1 to 3	1 to 3	1	NSYSFCVR124HD
NSYSFHD1612602D	1 to 4	1 to 4	1 to 4	1 to 3	1 to 4	1 to 3	1 to 3	1	NSYSFCVR126HD

Technical changes reserved. Information provided without guarantee. Images are for illustrative purposes only.

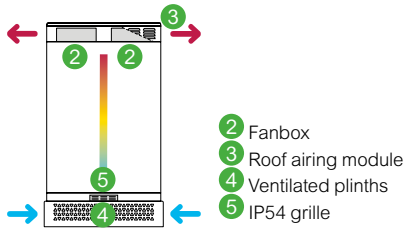

This table helps to configure thermal architectures, but it is highly recommended to use ProClima Software to ensure the right thermal solution according to the selected architecture.

I-Line	
<ul style="list-style-type: none"> • Integrated architecture particularly suitable for public areas • High thermal extraction capacity up to 1500 W • Noise level with 1 fan: 55 dB when installed inside the upper airing module • Good extraction flow rate power • Air flow in vertical axis 	

IP54 outlet grille (NSYCAG223LPF + G3 filter NSYCAF223T)	Ventilated plinths	Fanbox (1 filter NSYCAF190 for each Fanbox)	Roof airing module
--	--------------------	---	--------------------

Amount to be installed		References		Amount to be installed		References	
-	-	-	-	-	-	-	-
-	-	-	-	-	-	-	-
-	-	-	-	-	-	-	-
-	-	-	-	-	-	-	-
1 to 2	1	NSYZZ274VHD	-	1 to 2	1	NSYPCVR74HD	-
1 to 2	1	NSYZZ274VHD	-	1 to 2	1	NSYPCVR74HD	-
1 to 2	1	NSYZZ276VHD	-	1 to 2	1	NSYPCVR76HD	-
1 to 2	1	NSYZZ276VHD	-	1 to 2	1	NSYPCVR76HD	-
1	1	NSYZZ254VHD	-	1	1	NSYPCVR54HD	-
1	1	NSYZZ254VHD	-	1	1	NSYPCVR54HD	-
1 to 2	1	NSYZZ274VHD	-	1 to 2	1	NSYPCVR74HD	-
1 to 2	1	NSYZZ274VHD	-	1 to 2	1	NSYPCVR74HD	-
1 to 3	1	NSYZZ2124VHD	-	1 to 3	1	NSYPCVR124HD	-
1 to 3	1	NSYZZ2124VHD	-	1 to 3	1	NSYPCVR124HD	-
1 to 3	1	NSYZZ2126VHD	-	1 to 3	1	NSYPCVR126HD	-
1 to 3	1	NSYZZ2126VHD	-	1 to 3	1	NSYPCVR126HD	-
1	1	NSYZZ254VHD	-	1	1	NSYPCVR54HD	-
1	1	NSYZZ254VHD	-	1	1	NSYPCVR54HD	-
1 to 2	1	NSYZZ274VHD	-	1 to 2	1	NSYPCVR74HD	-
1 to 2	1	NSYZZ274VHD	-	1 to 2	1	NSYPCVR74HD	-
1 to 2	1	NSYZZ276VHD	-	1 to 2	1	NSYPCVR76HD	-
1 to 2	1	NSYZZ276VHD	-	1 to 2	1	NSYPCVR76HD	-
1 to 3	1	NSYZZ2124VHD	-	1 to 3	1	NSYPCVR124HD	-
1 to 3	1	NSYZZ2124VHD	-	1 to 3	1	NSYPCVR124HD	-
1 to 3	1	NSYZZ2126VHD	-	1 to 3	1	NSYPCVR126HD	-
1 to 3	1	NSYZZ2126VHD	-	1 to 3	1	NSYPCVR126HD	-
1 to 2	1	NSYZZ274VHD	-	1 to 2	1	NSYPCVR74HD	-
1 to 2	1	NSYZZ274VHD	-	1 to 2	1	NSYPCVR74HD	-
1 to 2	1	NSYZZ276VHD	-	1 to 2	1	NSYPCVR76HD	-
1 to 2	1	NSYZZ276VHD	-	1 to 2	1	NSYPCVR76HD	-
1 to 2	1	NSYZZ274VHD	-	1 to 2	1	NSYPCVR74HD	-
1 to 2	1	NSYZZ274VHD	-	1 to 2	1	NSYPCVR74HD	-

1	1	NSYSPFVX6200	NSYSPSX3200	-	-	-	-
1 to 2	1	NSYSPFVX8200	NSYSPLVX4200	1 to 2	1	NSYS3CVR84HD	-
1	1	NSYSPFVX6200	NSYSPLVX4200	1	1	NSYS3CVR64HD	-
1	1	NSYSPFVX8200	NSYSPLVX4200	1 to 2	1	NSYS3CVR84HD	-
1	1	NSYSPFVX6200	NSYSPLVX4200	1	1	NSYSFCVR64HD	-
1	1	NSYSPFVX6200	NSYSPLVX6200	1	1	NSYSFCVR66HD	-
1 to 2	1	NSYSPFVX8200	NSYSPLVX4200	1 to 2	1	NSYSFCVR84HD	-
1 to 2	1	NSYSPFVX8200	NSYSPLVX6200	1 to 2	1	NSYSFECA66HD	-
1	1	NSYSPFVX6200	NSYSPLVX6200	1	1	NSYSFCVR66HD	-
1 to 2	1	NSYSPFVX8200	NSYSPLVX4200	1 to 2	1	NSYSFCVR84HD	-
1 to 2	1	NSYSPFVX8200	NSYSPLVX6200	1 to 2	1	NSYSFECA66HD	-
1 to 2	1	NSYSPFVX8200	NSYSPLVX4200	1 to 2	1	NSYSFCVR84HD	-
1 to 3	1	NSYSPFVX12200	NSYSPLVX4200	1 to 3	1	NSYSFCVR124HD	-
1 to 3	1	NSYSPFVX12200	NSYSPLVX6200	1 to 3	1	NSYSFCVR126HD	-
1 to 3	1	NSYSPFVX12200	NSYSPLVX4200	1 to 3	1	NSYSFCVR124HD	-
1 to 3	1	NSYSPFVX12200	NSYSPLVX6200	1 to 3	1	NSYSFCVR126HD	-

POLYESTER Thalassa PHD				
Test description	Standard	Standard title	Certification	Declaration
IP55, IK10, lifting: 500 (1102.31) kg (lbs.) max. (IP65 for wall-mounted)	IEC 62208: 2011	Empty enclosures for low-voltage switchgear and controlgear assemblies - General requirements	●	-
Class II Insulation	IEC 61439-1: 2011	Low-voltage switchgear and controlgear assemblies Part 1: General rules	-	✓
Strength of materials and parts	IEC 61439-5: 2010	Low-voltage switchgear and controlgear assemblies Part 5: Assemblies for power distribution in public networks	●	-
Corrosion resistance C4H. It affects the painted accessories (ventilated roof, anti-burglary kit). All other metal parts have special treatment to pass the same test.	ISO 12.944: 2018	Paints and varnishes-corrosion protection of steel structures by protective paint systems Part 6: laboratory performance testing methods	-	✓
Climatic test, Biological Test, Resistance against chemically and mechanical active substances. Mechanical test, Lifting and stiffness test	IEC 61969-3: 2011	Electronic "Mechanical structures for electronic equipment - Outdoor enclosures" Part 3: Environmental requirements, tests and safety aspects	●	-
Space for electronics	IEC 60297-3-100: 2009	Mechanical structures for electronic equipment Dimensions of mechanical structures of the 482.6 (19.00) mm (in.) series - Part 3-100: Basic dimensions of front panels, subracks, chassis, racks and cabinets	-	✓
Dimensional	EIA-310-E	Cabinets, Racks, Panels, and associated equipment	-	✓
Fire resistance	EN 1794-2:2011	Vandalism: Fire resistance	-	✓
Posting	Internal test	Door anti-posting internal test	-	✓
Single-door: types 1, 2, 3, 3R, 4, 4X, 5, 12 and 13 Double-door: types 1, 2, 3, 3R, 5, 12 and 13	UL 508 A: 2007	Standard for Industrial Control Panels	●	-
Spacial SFHD (floor-standing enclosures)				
IP55, IK10, lifting: 1000 (2204.62) kg (lbs.) max.	IEC 62208: 2011	Empty enclosures for low-voltage switchgear and controlgear assemblies - General requirements	●	-
Strength of materials and parts	IEC 61.439-5: 2010	Low-voltage switchgear and controlgear assemblies Part 5: Assemblies for power distribution in public networks	●	-
Corrosion resistance C4H	ISO 12.944: 2018	Paints and varnishes-corrosion protection of steel structures by protective paint systems Part 6: laboratory performance testing methods	●	-
Climatic test, Biological Test, Resistance against chemically and mechanical active substances. Mechanical test, Lifting and stiffness test	IEC 61969-3: 2011	Electronic "Mechanical structures for electronic equipment - Outdoor enclosures" Part 3: Environmental requirements, tests and safety aspects	●	-
Space for electronics	IEC 60297-3-100: 2009	Mechanical structures for electronic equipment Dimensions of mechanical structures of the 482.6 (19.00) mm (in.) series - Part 3-100: Basic dimensions of front panels, subracks, chassis, racks and cabinets	-	✓
Dimensional	EIA-310-E	Cabinets, Racks, Panels, and associated equipment	-	✓
Single-door: Types 1, 3R, 12, 12K Double-door: Types 1, 3R, 12, 12K	UL 508 A: 2007	Standard for Industrial Control Panels	●	-
Spacial S3HD (wall-mounted enclosures)				
IP66, IK10, lifting: 200 (440.92) kg (lbs.) max.	IEC 62208: 2011	Empty enclosures for low-voltage switchgear and controlgear assemblies - General requirements	●	-
Strength of materials and parts	IEC 61.439-5: 2010	Low-voltage switchgear and controlgear assemblies Part 5: Assemblies for power distribution in public networks	●	-
Corrosion resistance C4H	ISO 12.944: 2018	Paints and varnishes-corrosion protection of steel structures by protective paint systems Part 6: Laboratory performance testing methods	●	-
Climatic test, Biological Test, Resistance against chemically and mechanical active substances. Mechanical test, Lifting and stiffness test	IEC 61969-3: 2011	Electronic "Mechanical structures for electronic equipment - Outdoor enclosures" Part 3: Environmental requirements, tests and safety aspects	●	-
Space for electronics	IEC 60297-3-100: 2009	Mechanical structures for electronic equipment Dimensions of mechanical structures of the 482.6 (19.00) mm (in.) series - Part 3-100: Basic dimensions of front panels, subracks, chassis, racks and cabinets	-	✓
Dimensional	EIA-310-E	Cabinets, Racks, Panels, and associated equipment	-	✓
Single-door: Types 1, 2, 3, 3R, 4, 4X, 5, 12 and 13	UL 508 A: 2007	Standard for Industrial Control Panels	●	-

HD ACCESSORIES HD THERMAL Management, Fanbox				
Test description	Standard	Standard title	Certification	Declaration
NSYCVF Series are intended for mounting on the flat surface of a Type 12 or 12K enclosure	UL 508A CAN/CSA-C22.2 No. 14, CAN/CSA C22.2 No. 94-M91 CAN/CSA C22.2 No. 73	Industrial Control Panels Industrial Control Equipment Special Purpose Enclosures Electrically Equipped Machine Tools	●	-
IP55 HD Metal grille (NSYCAG223LFHD)				
IP55 (in conditions of use)	IEC 60529: 2013	Degrees of protection provided by enclosures (IP Code)	-	✓
Corrosion resistance C4H	ISO 12.944: 2018	Paints and varnishes-corrosion protection of steel structures by protective paint systems - part 6: Laboratory performance testing methods	●	-
Anti-vandalism kit for HD metal grille (NSYCAAPVHD)				
Resistance Class 2	ENV 1627:2011	Burglar resistance - Requirements and classification	●	-
Upper airing module (PHD / SFHD / S3HD)				
IP55 (in conditions of use)	IEC 60529: 2013	Degrees of protection provided by enclosures (IP Code)	-	✓
Corrosion resistance at level C4H	ISO 12.944: 2018	Paints and varnishes-corrosion protection of steel structures by protective paint systems Part 6: Laboratory performance testing methods	●	-
HD POLYESTER ENCLOSURES				
Anti burglary accessory (NSYBGN•••HD)				
Resistance Class 2	ENV 1627:2011	Burglar resistance - Requirements and classification	●	-
Corrosion resistance at level C4H	ISO 12.944: 2018	Paints and varnishes-corrosion protection of steel structures by protective paint systems Part 6: Laboratory performance testing methods	●	-
ZZ plinths (NSYZZ••• and NSYZZ•••VHD)				
ZZ Plinth: IP44 (in conditions of use) Ventilated ZZ Plinth: IP43 (in conditions of use)	IEC 60.529:2013	Degrees of protection provided by enclosures (IP Code)	-	✓
Eyebolts (NSYPLHD)				
Maximum load 500 (1102.31) kg (lbs.)	IEC 62208: 2011	Empty enclosures for low-voltage switchgear and controlgear assemblies - General requirements	-	✓
HD STEEL ENCLOSURES				
Stainless-steel plinths (NSYSPFVX••• / NSYSPLVX••• / NSYSPSX••• / NSYSPSX•••)				
Ventilated plinth: IP20 (in conditions of use) Standard plinth: IP30 (in conditions of use)	IEC 60.529:2013	Degrees of protection provided by enclosures (IP Code)	-	✓

Horizontal wall-mounted enclosures designed for photovoltaic and multiple outdoor applications installed in harsh environments

New

- Wall-mounted enclosures made of **fiberglass reinforced polyester** molded by hot compression.
- Monobloc body with polyurethane gasket.
- **Wider sizes with more space available in the bottom of the enclosure** to install additional cable entries.
- **Impact resistance IK10**, IEC 62262.
- **Protection degree IP 66**, IEC 60529.
- Class II insulation.
- Certifications: **IEC 62208 & UL 508A - NEMA type: 1, 2, 3, 3R, 3S, 4, 4X, 5, 12 and 13.**
- Reach & RoHs compliance.
- Color: **RAL 7035.**

Removable door system

- Removable door system that allows:
 - Total access without limitations to the internal part of the enclosure.
 - Easy and quick assembly/disassembly of the door. (without dismantling the hinges and removing the pin)



Self-adhesive and fixable canopy

- Self-adhesive and fixable canopy made of PVC available as an accessory - black RAL 9005 Color. Die-cut to be easily fixed by two screws. IP degree is maintained.
- For outdoor use, the canopy must be installed to protect the door gasket against water stagnation.

Wall fixing lugs

- Set of 4 wall fixing lugs (plastic or stainless-steel) available as an accessory.
- Quick and easy assembly through the inserts, without drilling the enclosure. IP guaranteed.

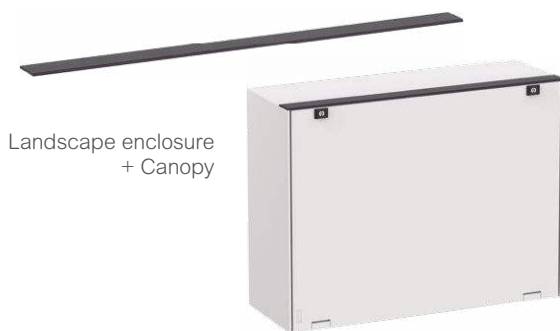

Landscape enclosures. RAL 7035



NSYS3HD3215



NSYPLM810G

Characteristics	Height mm (in.)	Width mm (in.)	Depth mm (in.)	Number of locks	References
Landscape enclosures. RAL 7035	536 (21.10)	747 (29.41)	300 (11.81)	2	NSYPLM57G New
Landscape enclosures. RAL 7035	636 (25.04)	847 (33.35)	300 (11.81)	2	NSYPLM68G New
Landscape enclosures. RAL 7035	852 (33.54)	1056 (41.58)	350 (13.78)	1	NSYPLM810G New

Canopy PVC - RAL 9005

- Self-adhesive & fixable by screws
- Holes pre die-cut
- IP is maintained



NSYS3HD3215

Characteristics	Height mm (in.)	Width mm (in.)	Depth mm (in.)	Enclosure	References
Canopy PVC - RAL 9005	5 (0.20)	747 (29.41)	62 (2.44)	NSYPLM57G	NSYCSA57 New
Canopy PVC - RAL 9005	5 (0.20)	847 (33.35)	62 (2.44)	NSYPLM68G	NSYCSA68 New
Canopy PVC - RAL 9005	5 (0.20)	1056 (41.58)	62 (2.44)	NSYPLM810G	NSYCSA810 New

Plain mounting plate



NSYMM75

- Material: Galvanized steel

Characteristics	Dimensions (W x D) mm (in.)	Enclosure	References
Plain mounting plate, for wall-mounted enclosure	700 (27.56) x 500 (19.68)	NSYPLM57G	NSYMM75
Plain mounting plate, for wall-mounted enclosure	800 (31.50) x 600 (23.62)	NSYPLM68G	NSYMM86
Plain mounting plate, for wall-mounted enclosure	1000 (39.37) x 800 (31.50)	NSYPLM810G	NSYMM108

Plain mounting plate



NSYMP75

- Material: Polyester

Characteristics	Dimensions (W x D) mm (in.)	Enclosure	References
Plain mounting plate, for wall-mounted enclosure	700 (27.56) x 500 (19.68)	NSYPLM57G	NSYMP75
Plain mounting plate, for wall-mounted enclosure	800 (31.50) x 600 (23.62)	NSYPLM68G	NSYMP86
Plain mounting plate, for wall-mounted enclosure	1000 (39.37) x 800 (31.50)	NSYPLM810G	NSYMP108

Wall fixing lugs



NSYFPPLMG

Set of 4 wall fixing lugs. Mounted directly on the enclosure, either in horizontal position or in vertical position.

- Material: Fiberglass-reinforced polyamide
- Color: RAL 7035 grey
- **Maximum load:**
On PLM32: Vertical or horizontal: 10 (22.05)kg (lbs.)
Other PLM models: Vertical position: 200 (440.93) kg (lbs.), horizontal position: 100 (220.55) kg (lbs.)

Supply:
Delivered with fixings

Characteristics	Reference
Wall fixing lugs	NSYFPPLMG

Wall fixing lugs



NSYFPXPLM

Set of 4 wall fixing lugs. Mounted directly on the enclosure, either in horizontal position or in vertical position.

- Material: Stainless-steel
- Color: RAL 7035 grey
- **Maximum load:**
Other PLM models: Vertical position: 200 (440.93) kg (lbs.), horizontal position: 100 (220.55) kg (lbs.)

Supply:
Delivered with fixings

Characteristics	Reference
Wall fixing lugs	NSYFPXPLM



Scan or click for video



The seismic risk

No point of the globe is immune to an earthquake. However, the probability of being subjected to an earthquake of a given intensity varies from one location to another. The map below, taken from IEC 60721-2-6, shows the distribution of the seismic risk on the 5 continents.

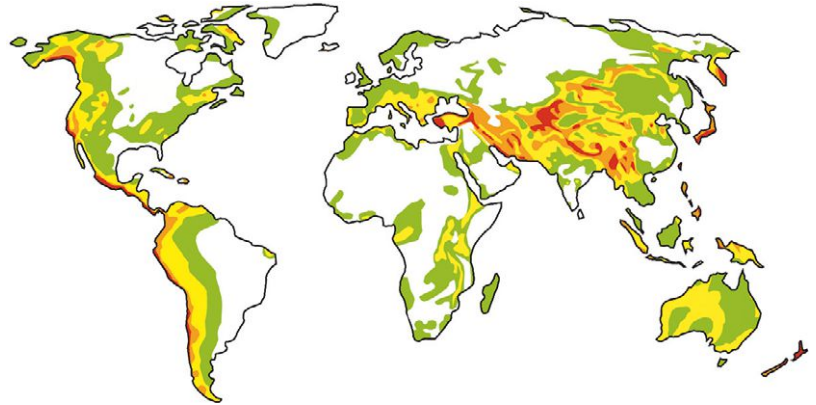
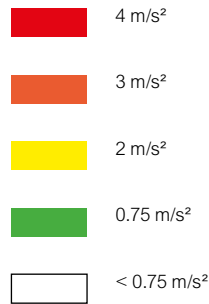

Spacial enclosures and the seismic constraint

Spacial standard range solutions

The Spacial standard offers have been qualified for use in areas subject to medium intensity earthquakes (ground acceleration $\leq 3 \text{ m/s}^2$).

For details of the seismic resistance of the standard offers, refer to the individual chapters of the following offers:

- S3D, CRN, CRNG et 19" wall-mounted enclosures,
- SBM industrial boxes,
- SF enclosures (automation and monitoring/control),
- PrismaSeT HD enclosures (functional system for low-voltage electricity distribution),
- 19" SF enclosures (pivoting rack).

Enclosures for strong earthquakes

In order to meet the requirements of high-seismic zones (ground acceleration $\geq 4 \text{ m/s}^2$), Schneider Electric has developed 2 offers:

- Floor-standing enclosures SF 6G and PrismaSeT HD 5G,
- Wall-mounted enclosure S3D 6G,

Certifications

All tests have been performed according to the following technical regulations:

- IEC 60068-3-3 (first edition): International standard. Environmental testing – Part 3 : Guidance – Seismic test methods for equipment
- CRT 91-C-112-00: Seismic resistance of equipment Generic provisions for bi-axial testing using accelerograms

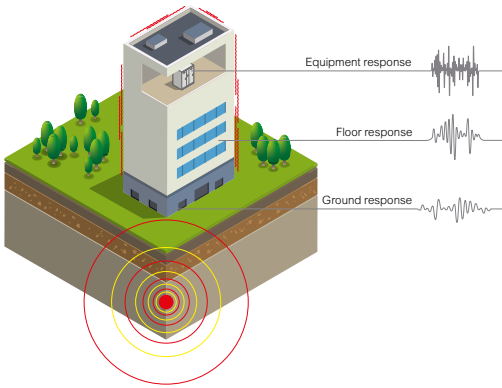

Technical information

Seismic standards

There is no single international standard. The standards depend on each country/zone and are linked to civil engineering standards.

The main ones are:

- International Building Code (I.B.C. Ex UBC)
- IEC 60068-3-3,
- EDF specification CRT 91C11200 (ex-HN-20-E-53)

The Spacial enclosures have been tested according to standards IEC 60068-3-3 and CRT 91-C-112-00. CRT 91-C-112-00 is one of the most restrictive specifications, and for which it is therefore more difficult to obtain certification.

Geology
Equivalence between scales characterizing the earthquake

MSK	Richter	IEC 60068-3-3 (ground acc.)
<VIII	< 5.5	2 m/s ²
VIII to IX	≥ 5.5 and ≤ 7	3 m/s ²
>IX	> 7	5 m/s ²

To define the seismic resistance of equipment, it is necessary to take into account the geological characteristics of the earthquake and the behavior of the building, and compare these with the equipment's seismic performance.

Civil engineering
Example acceleration levels on the floor of a building (RRS)

All types of building (IEC 60068-3-3)

6 m/s ²
9 m/s ²
15 m/s ²

Definitions

Ground acceleration: Ground acceleration resulting from an earthquake.
Note: In practice, ground acceleration can be broken down into horizontal and vertical components.

Floor acceleration: Ground acceleration measured on a particular floor in a building (at the location of an equipment item).

Note: In practice, floor acceleration can be broken down into horizontal and vertical components.

Required response spectrum (RRS): Representation of the amplification of the ground acceleration caused by the structure or equipment according to the wave frequency. Used for determining equipment dimensions and qualifying the equipment.

Test response spectrum (TRS): Representation of the amplification of tested products during tests on vibrating table.

Equipment performance tested according to CRT 91 C 112 00

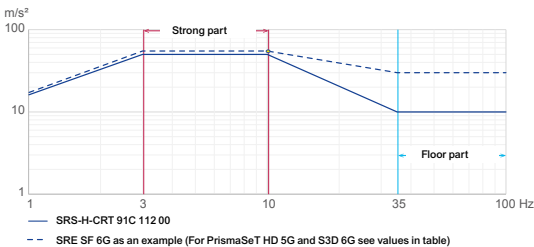

Two parts are defined in the response spectra:

- **Floor part:** On the product zone in contact with the vibrating table there is no amplification of the acceleration. The acceleration value recorded for the spectrum is that measured on the ground.
- **Strong part:** The acceleration value recorded for the spectrum is the maximum amplified acceleration expected at the center of gravity of the equipment. This is not a measurable quantity but a mathematical representation.

Products	Floor part acc	Strong part acc
PrismaSeT HD 5G	20 m/s ²	50 m/s ²
SF 6G*	30 m/s ²	50 m/s ²
S3D 6G*	30 m/s ²	55 m/s ²

Conclusion: The TRS values must be compared to the RRS values. If they are greater, the equipment will resist the effects of the earthquake.

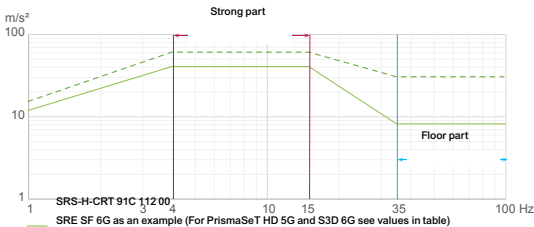

Products	Floor part acc	Strong part acc
PrismaSeT HD 5G	20 m/s ²	40 m/s ²
SF 6G*	30 m/s ²	60 m/s ²
S3D 6G*	30 m/s ²	80 m/s ²

The **Spacial SF 6G** enclosures have been designed to withstand earthquakes corresponding to UBC Zone 4.

Spacial SF 6G for seismic risks



Panel mounting

- 12 fastening points by M6 screws per panel..



Plinths

- Enhanced mechanical strength (monobloc structure).
- Assembled on the enclosure.
- Floor fixing: 10 fastening points by M12 screws.



Security locking system

- Seismic locking system.
- Special connecting rods and handle to prevent any accidental door opening under severe vibration conditions.



Multi-purpose corners

- To strengthen the enclosure and respond to seismic risks.
- To strengthen fastening of the side panels and rear panel.
- To fasten the door connecting rods.

Spacial SF 6G for seismic risks



NSYSF6G20680

- Enclosures designed to be installed in UBC Zone 4.
- They have been tested with a plain mounting plate and 19" rack.
- Integrated plinth.
- Material: Steel
- Ingress protection rating: IP55 according to IEC 60529
- Mechanical protection rating: IK10 according to IEC 62262
- Maximum load: 80 (176.37) kg (lbs.)/m² on plain mounting plate,
- Standards: IEC 62208 (enclosure) - IEC 60068-3-3 (seismic methods to apply for materials)
- Certifications: 6G certification as per CRT 91-C-112-00 (EDF) - UL 508 types 1, 3R, 12

Characteristics	Height mm (in.)	Width mm (in.)	Depth mm (in.)	References
Spacial SF 6G	2000 (78.74)	600 (23.62)	800 (31.50)	NSYSF6G20680
Spacial SF 6G	2000 (78.74)	800 (31.50)	600 (23.62)	NSYSF6G20860
Spacial SF 6G	2000 (78.74)	800 (31.50)	800 (31.50)	NSYSF6G20880

Supply:

Framework

- 1 upper frame with roof
- 1 lower frame
- 1 rear panel
- 4 uprights
- 8 multi-purpose reinforcement corners
- 8 cross-rails fastened to the framework contributing to the seismic resistance (3 left, 3 right, 2 rear)

Plinth

- Monobloc base 4 (0.16) mm (in.) thick, 100 (3.94) mm (in.) high

Door

- Plain door with EDF 1600 captive key lock
- 3 fastening points with connecting rods
- Door hinges on right (opposite direction available on request)

Coupling

- Possibility to couple SF 6G enclosures with the coupling kits ref. **NSYSFBK19** + **NSYSFBKR**
- Possibility to couple plinth with the ref. **NSYPLK6G**

Side panels



NSY6G2SP206

- Enclosures designed to be installed in UBC Zone 4.
- They have been tested with a plain mounting plate and 19" rack.
- Integrated plinth.
- Material: Steel
- Installation: 12 fastening points

Supply:

2 side panels and fasteners

Characteristics	Height mm (in.)	Depth mm (in.)	References
Side panel	2000 (78.74)	600 (23.62)	NSY6G2SP206
Side panel	2000 (78.74)	800 (31.50)	NSY6G2SP208

Mounting plate



NSYMP206

- Material: Galvanized steel
- Installation: Mounting plate to be installed with **NSYSFPB6G** fastening kit + **NSYHLCR●●** cross-rails

Supply:

1 mounting plate and sliding shoes

Characteristics	Height mm (in.)	Depth mm (in.)	References
Mounting plate	2000 (78.74)	600 (23.62)	NSYMP206
Mounting plate	2000 (78.74)	800 (31.50)	NSYMP208

Rails for heavy load

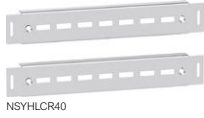

NSYHLCR40

- Material: Zinc-coated steel

Characteristics	Depth mm (in.)	References
Rails for heavy load	400 (15.75)	NSYHLCR40
Rails for heavy load	600 (23.62)	NSYHLCR60
Rails for heavy load	800 (31.50)	NSYHLCR80

Supply:
2 cross-rails and fixing elements

Reinforced fixing kit for mounting plate

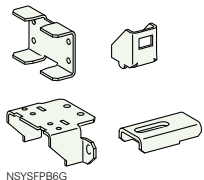

NSYSFPB6G

- Material: Steel

Characteristics	References
Reinforced fixing kit for mounting plate	NSYSFPB6G

Supply:
6 anti-vibration supports
4 mounting brackets
4 supports
2 connectors and fixing elements

Trim cap for SF 6G panels



NSYCSP6G

- Material: Plastic

Characteristics	References
Trim cap for SF 6G panels	NSYCSP6G

Supply:
50 units

19" fixed uprights

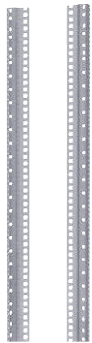

NSYRCK42

- Uprights designed to be assembled on enclosures 800 (31.50) mm (in.) wide and 800 (31.50) mm (in.) deep.
- Material: Zinc-coated steel
- Fixing: To fasten the 19" uprights, it is necessary to use the fixing kit **NSYRCK19KIT6G**

Characteristics	References
19" fixed uprights	NSYRCK42

Note:
For a 19" seismic configuration, 4 uprights must be used

Supply:
2 uprights and fasteners,

19" fixed uprights

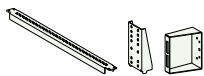

NSYRCK19KIT6G

- Material: Steel

Characteristics	References
19" fixed uprights	NSYRCK19KIT6G

Supply:
4 cross-rails
8 fastening brackets
4 reinforcements
Fixing elements

Optional locks for enclosure



NSYAEDLEDF9K33

- With captive key.
- Material: Polyamide handle, metal connecting rods and cam

Characteristics	References
Optional lock for enclosure, EDF 900	NSYAEDLEDF9K33
Optional lock for enclosure, EDF 1300	NSYAEDLEDF13K33
Optional lock for enclosure, EDF 1400	NSYAEDLEDF14K33
Optional lock for enclosure, 1242E	NSYAEDL1242K33
Optional lock for enclosure, 405E	NSYAEDL405K33
Optional lock for enclosure, 455E	NSYAEDL455K33

Supply:
3-point lock with
1 lock button and
1 cremone screw

Local seismic standards: Conformity with acceleration severity levels

Standards	Specifications
EDF book of technical rules CRT 91C11200	"Large equipment" MRI RRS: Horizontal: Floor acceleration = 2 (0.07) g (oz.) Amplified max. acceleration at center of gravity = 5 (0.18) g (oz.) Vertical: Floor acceleration = 2.4 (0.08) g (oz.) Amplified max. acceleration at center of gravity = 6 (0.21) g (oz.)
EAK 2000 Greece	Seismic risk zone: IV Importance category: S4
ENDESA 1986	All seismic categories Ground acceleration = 0.5 (0.02) g (oz.)
RPA 99 2003 Algeria	All types of soil class Ground acceleration factor A = 0.36 Behavior factor R = 2 Quality factor Q = 1.35
Core GR 63 Turkish Seismic Code 2009	Zone 4 All types of site class Importance factor = 1.5 Ground acceleration factor: A0 = 0.4
GOST 17516.1-90 Russia	Civil market: MSK intensity 9, level 3. Nuclear market: MSK intensity 9, level 2.
IEEE 693-2005 Eurocode 8	High level All soil types agR = 3 m/s ² Importance factor = 1.3

Spacial SF 6G for seismic risks

Busbar compartment enclosure, available depths with conformity declaration

Height mm (in.)	Width mm (in.)			
	300 (11.81)	400 (15.75)	600 (23.62)	800 (31.50)
2200 (86.61)	-	600 (23.62)	-	-
2000 (78.74)	500 (19.68) / 600 (23.62) / 800 (31.50)	400 (15.75) / 500 (19.68) / 600 (23.62) / 800 (31.50)	-	-
1800 (70.87)	-	400 (15.75) / 500 (19.68) / 600 (23.62)	-	-
1600 (62.99)	-	-	-	-
1400 (55.12)	-	-	-	-
1200 (47.24)	-	-	-	-

Enclosure equipped with plain mounting plate, available depths

Height mm (in.)	Width mm (in.)			
	300 (11.81)	400 (15.75)	600 (23.62)	800 (31.50)
2200 (86.61)	-	-	800 (31.50)	600 (23.62) / 800 (31.50)
1800 (70.87)	-	-	600 (23.62) / 800 (31.50)	600 (23.62)
1600 (62.99)	-	-	600 (23.62) / 800 (31.50)	600 (23.62) / 800 (31.50)
1200 (47.24)	-	-	400 (15.75) / 600 (23.62)	400 (15.75) / 600 (23.62)

Enclosure equipped with 19" fixed rack, available depths

Height mm (in.)	Width mm (in.)			
	300 (11.81)	400 (15.75)	600 (23.62)	800 (31.50)
2200 (86.61)	-	-	-	800 (31.50)
2000 (78.74)	-	-	-	-
1600 (62.99)	-	-	-	800 (31.50)
1400 (55.12)	-	-	-	-
1200 (47.24)	-	-	-	-

SF enclosures for seismic risks Compatibility of accessories

Accessories Trade references impacted	Description	SF 6G compatibility	Comments
NSYSDT●	Folding mounting shelf	Please contact us	Depends on size
NSYSDP●M	Metal document holder	Please contact us	Depends on size
NSYDPA●●	Plastic document holder	Compatible	-
NSYMP●●●	Mounting plate	Compatible	Position 200 (7.87) mm (in.) mini from the rear panel
NSYSUCR●●	Universal cross-rail	Compatible	-
NSYSQCR●●	Quick cross-rail	Compatible	-
NSYSICR●●	Integrated cross-rail	Compatible	-
NSYHLCR●●	Cross-rail for heavy loads	Compatible	-
NSYSLCR●●	Light cross-rail	Compatible	-
NSYFXT●●●●	Fixed Trays	Compatible	-
NSYSPMP●	Partial plain mounting plate	Compatible	-
NSYSTMP●●	Telequick mounting plate	Compatible	-
NSYSDCR●●	Door cable-guide cross-rail	Compatible	Select the smaller-sized cross-rail

Spacial SF 6G for seismic risks

Cut-outs

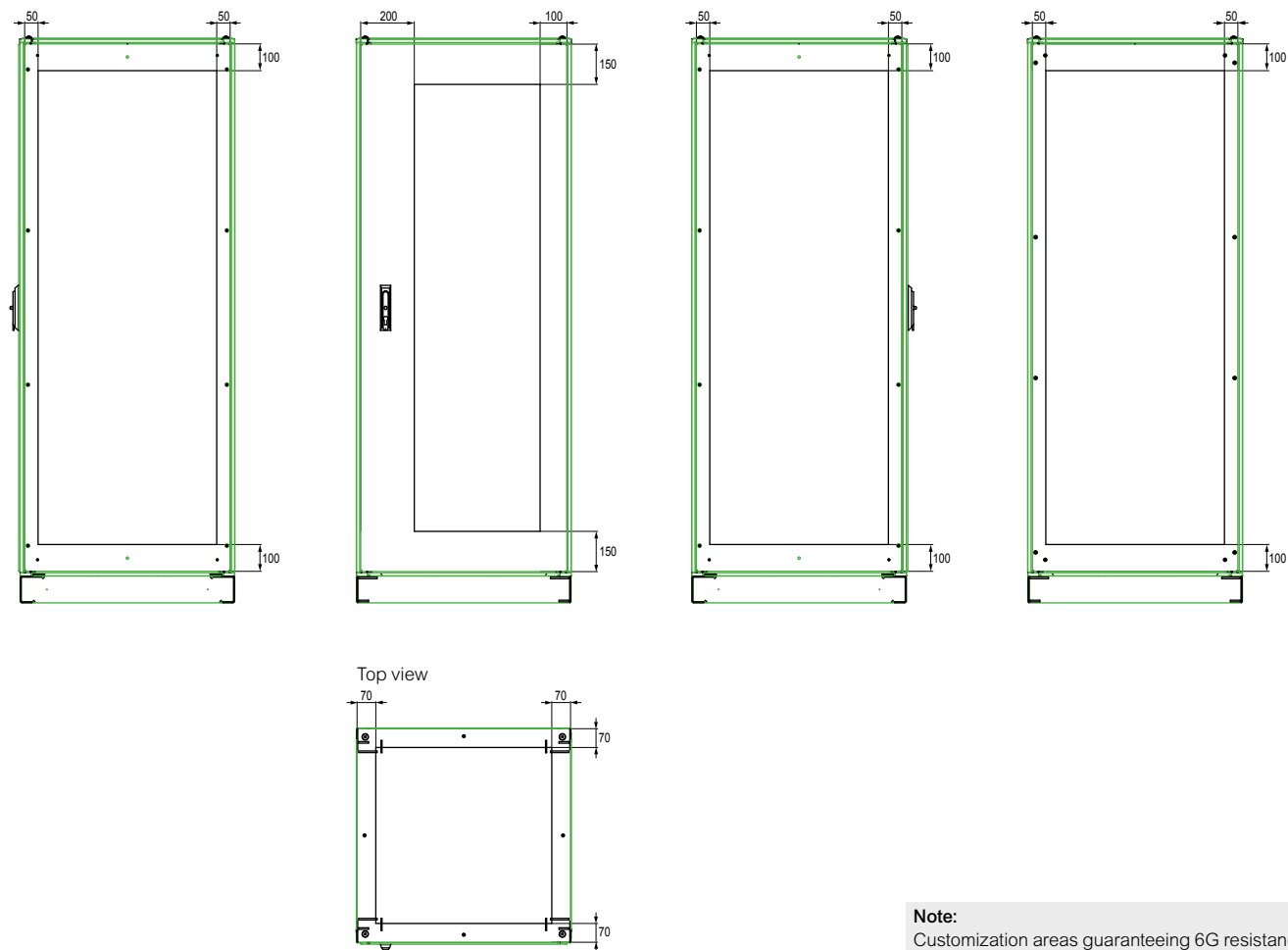

Note:
Customization areas guaranteeing 6G resistance

Spacial S3D 6G enclosures are designed to withstand earthquakes up to UBC zone 4.



Strength

Panel thickness:

- Casing + door: 20 (0.79)/10 mm (in.);
- Entry flange: 15 (0.59)/10 mm (in.).



Reinforced mounting plate

- Mounting plate reinforcement.
- Increased number of attachment points.



Security locking system

- EDF 1600 security locking system with captive key.



Wall-mounted

- Reinforced bracket for wall-mounted.

Spacial S3D 6G solutions for seismic risks

- Seismic applications up to UBC zone 4.
- Material: Steel
- Ingress protection rating: IP65 according to IEC 60529
- Mechanical protection rating: IK10 according to IEC 62262
- Maximum load: 80 (176.37) kg (lbs.)/m² on plain mounting plate, 250 (551.16) kg (lbs.) on 19" fixed uprights
- Standards: IEC 62208 (enclosure) - IEC 60068-3-3 (seismic methods to apply for materials)
- Certifications: 6G certification as per CRT 91-C-112-00 (EDF)

Supply:

Body

- Monobloc casing (cross structure). Gutter-shaped front profile. Flat back
- M6 x 16 (0.63) mm (in.) earthing screws and earth strap for equipotential connection between the enclosure door and casing
- Entry flange
- Maximum load: 10 (22.05) kg (lbs.)

Door

- Plain door with EDF 1600 captive key lock
 - H < 600: 1 fastening point
 - H ≥ 600: 3 fastening points
- Non-reversible door (for reversibility, please contact us)
- M6 x 16 earthing screws and earth strap for equipotential connection between the enclosure door and casing
- 120° door opening
- Maximum load: 10 (22.05) kg (lbs.)

Mounting plate

- Mounting plate galvanized before mounting
- Maximum load: 80 (176.37) kg (lbs.)/m²
- Two wall-mounted brackets



NSYS3D6G32515P

Characteristics	Height mm (in.)	Width mm (in.)	Depth mm (in.)	References
Spacial S3D seismic plain door with mount.plate	300 (11.81)	250 (9.84)	150 (5.91)	NSYS3D6G32515P
Spacial S3D seismic plain door with mount.plate	400 (15.75)	300 (11.81)	200 (7.87)	NSYS3D6G4320P
Spacial S3D seismic plain door with mount.plate	600 (23.62)	500 (19.68)	250 (9.84)	NSYS3D6G6525P
Spacial S3D seismic plain door with mount.plate	700 (27.56)	500 (19.68)	250 (9.84)	NSYS3D6G7525P
Spacial S3D seismic plain door with mount.plate	800 (31.50)	600 (23.62)	300 (11.81)	NSYS3D6G8630P
Spacial S3D seismic plain door with mount.plate	1200 (47.24)	800 (31.50)	400 (15.75)	NSYS3D6G12840P

Locks for enclosure

- ≤ H 600 (23.62) mm (in.)
- With captive key.
- Material: Zamak lock and metal cam

Supply:

- 1- or 3-point lock with 1 lock button and 1 cremone screw



NSYAEDLEDF9K31

Characteristics	Key lock	References
Lock for enclosure	EDF 900	NSYAEDLEDF9K31
Lock for enclosure	EDF 1300	NSYAEDLEDF13K31
Lock for enclosure	EDF 1400	NSYAEDLEDF14K31
Lock for enclosure	1242E	NSYAEDL1242K31
Lock for enclosure	405E	NSYAEDL405K31
Lock for enclosure	455E	NSYAEDL455K31

Locks for enclosure

- > H 600 (23.62) mm (in.)
- With captive key.
- Material: Polyamide handle, metal connecting rods and cam

Supply:

- 3-point lock with 1 lock button and 1 cremone screw



NSYAEDLEDF9K33

Characteristics	Key lock	References
Lock for enclosure	EDF 900	NSYAEDLEDF9K33
Lock for enclosure	EDF 1300	NSYAEDLEDF13K33
Lock for enclosure	EDF 1400	NSYAEDLEDF14K33
Lock for enclosure	1242E	NSYAEDL1242K33
Lock for enclosure	405E	NSYAEDL405K33
Lock for enclosure	455E	NSYAEDL455K33

Padlocking lug

- Securing of enclosure access.
- Material: White galvanized steel



NSYAEDLPADS3DK3

Characteristics	References
Padlocking lug	NSYAEDLPADS3DK3

Local seismic standards: Conformity with acceleration severity levels ,not considered other aspects

Standards	Specifications
EDF book of technical rules CRT 91C11200	<p>Large equipment" MRI RRS:</p> <p>Horizontal:</p> <ul style="list-style-type: none"> • Floor acceleration = 2 (0.07) g (oz) • Amplified max. acceleration at center of gravity = 5 (0.18) g (oz) <p>Vertical:</p> <ul style="list-style-type: none"> • Floor acceleration = 2.4 (0.08) g (oz) • Amplified max. acceleration at center of gravity = 6 (0.21) g (oz)
EAK 2000 Greece	<p>Seismic risk zone: IV</p> <p>Importance category: S4</p>
ENDESA 1986	<p>All seismic categories</p> <p>Ground acceleration = 0.5 (0.02) g (oz)</p>
RPA 99 2003 Algeria	<p>All types of soil class</p> <p>Ground acceleration factor A = 0.36</p> <p>Behavior factor R = 2</p> <p>Quality factor Q = 1.35</p>
Turkish Seismic Code 2009	<p>All types of site class</p> <p>Importance factor = 1.5</p> <p>Ground acceleration factor: A0 = 0.4</p>
GOST 17516.1-90 Russia	<p>Civil market:</p> <p>MSK intensity 9, level 3.</p> <p>Nuclear market:</p> <p>MSK intensity 9, level 2.</p>
Eurocode 8	<p>All soil types</p> <p>agR = 3 m/s²</p> <p>Importance factor = 1.3</p>

Table of Compatibility of accessories in 6G seismic S3D enclosures

Accessories		Compatibility	Comments	Trade references impacted
	19" rack	Limited	Conditions: Drilling by customization department to be provided for	NSYVDM●●●●
	Door switch	Limited	Conditions: Drilling by customization department to be provided for	NSYINLCRN
	Diagram holder	Yes	-	NSYDPA●●
	Lifting rings	Limited	Conditions: Drilling by customization department to be provided for	NSYAELYTCRG8

Comment: None of the accessories is certified 6G.

The **Spacial S3D 6G K3** enclosure meets K3 requirements in accordance with RCCE 2012.

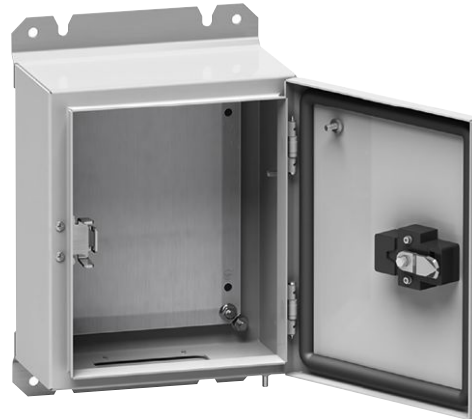

Strength

Panel thickness:

- Casing + door: 20 (0.79) / 10 (0.39) mm (in.);
- Entry flange: 15 (0.59) / 10 (0.39) mm (in.).



Reinforced mounting plate

- Mounting plate reinforcement.
- Increased number of attachment points.

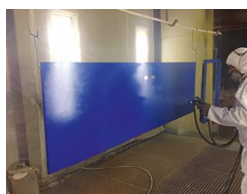

Decontaminable smooth paint, PID 100 series

- In compliance with CCTR 91.C.031.06
Two coats of paint
(minimum thickness: 60 μ).
- Epoxy polyester powder, PID 100 series.
- PIA-PIC 100 on request.



Earth continuity

- Earth continuity between the interior and exterior of the enclosure is provided by 2 opposite welded studs (external earth screw principle).

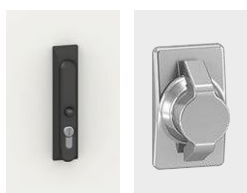

Security locking system

- EDF 1600 security locking system with captive key.



Wall-mounted

- Reinforced bracket for wall-mounted.

Spacial S3D 6G K3 solutions for nuclear applications

Seismic application for nuclear power station.

- Material: Steel
- Ingress protection rating: IP65 according to IEC 60529
- Mechanical protection rating: IK10 according to IEC 62262
- Standards: IEC 62208 - IEC 60068-3-3 (seismic methods to apply for materials)
- Certifications: 6G certification as per CRT 91-C-112-00 (EDF)
- Meets K3 requirements in accordance with RCCE 2012
- EDF reference documents:
 - CCTR paint and FNP file;
 - RCC-E: Electrical equipment construction code;
 - Packaging technical specification;
 - "PMUC" (products and materials used in nuclear generating stations)



NSYS3D32515PK3

Characteristics	Height mm (in.)	Width mm (in.)	Depth mm (in.)	References
Spacial S3D seismic plain door with mount.plate	300 (11.81)	250 (9.84)	150 (5.91)	NSYS3D32515PK3
Spacial S3D seismic plain door with mount.plate	400 (15.75)	300 (11.81)	200 (7.87)	NSYS3D4320PK3
Spacial S3D seismic plain door with mount.plate	600 (23.62)	500 (19.68)	250 (9.84)	NSYS3D6525PK3
Spacial S3D seismic plain door with mount.plate	700 (27.56)	500 (19.68)	250 (9.84)	NSYS3D7525PK3
Spacial S3D seismic plain door with mount.plate	800 (31.50)	600 (23.62)	300 (11.81)	NSYS3D8630PK3
Spacial S3D seismic plain door with mount.plate	1200 (47.24)	800 (31.50)	400 (15.75)	NSYS3D12840PK3

Supply:

Body

- Monobloc casing (cross structure). Gutter-shaped front profile. Flat back
- M6 x 16 earthing screws and earth strap for equipotential connection between the enclosure door and casing
- Entry flange
- Maximum load: 10 (22.05) kg (lbs.)

Door

- Plain door with EDF 1600 captive key lock
 - H < 600: 1 fastening point
 - H ≥ 600: 3 fastening points
- Non-reversible door (for reversibility, please contact us)
- M6 x 16 earthing screws and earth strap for equipotential connection between the enclosure door and casing
- 120° door opening
- Maximum load: 10 (22.05) kg (lbs.)

Mounting plate

- Mounting plate galvanized before mounting
- Maximum load: 80 (176.37) kg (lbs.)/m²
- Two wall-mounted brackets

Locks for enclosure

- ≤ H 600 (23.62) mm (in.)
- With captive key.
- Material: Zamak lock and metal cam



NSYAEDLEDF9K31

Characteristics	Key lock	References
Lock for enclosure	EDF 900	NSYAEDLEDF9K31
Lock for enclosure	EDF 1300	NSYAEDLEDF13K31
Lock for enclosure	EDF 1400	NSYAEDLEDF14K31
Lock for enclosure	1242E	NSYAEDL1242K31
Lock for enclosure	405E	NSYAEDL405K31
Lock for enclosure	455E	NSYAEDL455K31

Supply:

- 1- or 3-point lock with 1 lock button and 1 cremone screw

Locks for enclosure

- > H 600 (23.62) mm (in.)
- With captive key.
- Material: Polyamide handle, metal connecting rods and cam



NSYAEDLEDF9K33

Characteristics	Key lock	References
Lock for enclosure	EDF 900	NSYAEDLEDF9K33
Lock for enclosure	EDF 1300	NSYAEDLEDF13K33
Lock for enclosure	EDF 1400	NSYAEDLEDF14K33
Lock for enclosure	1242E	NSYAEDL1242K33
Lock for enclosure	405E	NSYAEDL405K33
Lock for enclosure	455E	NSYAEDL455K33

Supply:

- 3-point lock with 1 lock button and 1 cremone screw

Padlocking lug

- Securing of enclosure access.
- Material: White galvanized steel



NSYAEDLPADS3DK3

Characteristics	References
Padlocking lug	NSYAEDLPADS3DK3

Table of Compatibility of accessories in 6G seismic S3D enclosures

Accessories		Compatibility	Comments	Trade references impacted
	19" rack	Limited	Conditions: Drilling by customization department to be provided for	NSYVDM●●●●
	Door switch	Limited	Conditions: Drilling by customization department to be provided for	NSYINLCRN
	Diagram holder	Yes	-	NSYDPA●●
	Lifting rings	Limited	Conditions: Drilling by customization department to be provided for	NSYAELYTCR8

Comment: None of the accessories is certified 6G.

Special dimensions

Height mm (in.)	Width mm (in.)					
	250 (9.84)	300 (11.81)	400 (15.75)	500 (19.68)	600 (23.62)	800 (31.50)
1200 (47.24)	-	-	-	-	200 (7.87) / 250 (9.84) / 300 (11.81) / 400 (15.75)	200 (7.87) / 250 (9.84) / 300 (11.81) / 400 (15.75)
1000 (39.37)	-	-	-	-	200 (7.87) / 250 (9.84) / 300 (11.81) / 400 (15.75)	200 (7.87) / 250 (9.84) / 300 (11.81) / 400 (15.75)
800 (31.50)	-	-	200 (7.87) / 250 (9.84) / 300 (11.81)	200 (7.87) / 250 (9.84) / 300 (11.81)	200 (7.87) / 250 (9.84) / 400 (15.75)	200 (7.87) / 250 (9.84) / 300 (11.81)
700 (27.56)	-	-	200 (7.87) / 250 (9.84) / 300 (11.81)	200 (7.87) / 300 (11.81)	200 (7.87) / 250 (9.84) / 300 (11.81) / 400 (15.75)	-
600 (23.62)	-	-	200 (7.87) / 250 (9.84) / 300 (11.81)	200 (7.87) / 300 (11.81)	200 (7.87) / 250 (9.84) / 300 (11.81) / 400 (15.75)	-
500 (19.68)	200 (7.87)	150 (5.91) / 200 (7.87) / 250 (9.84)	200 (7.87) / 250 (9.84) / 300 (11.81)	200 (7.87) / 250 (9.84) / 300 (11.81)	-	-
400 (15.75)	150 (5.91) / 200 (7.87)	150 (5.91) / 250 (9.84)	-	-	-	-
300 (11.81)	150 (5.91) / 200 (7.87)	150 (5.91) / 200 (7.87) / 250 (9.84)	-	-	-	-

Note:

We meet the K3 requirements as per RCCE 2012 for the special dimensions mentioned below. These dimensions appear in the Reference File.

Cut-outs

Customization areas ensuring K3 certification

Door

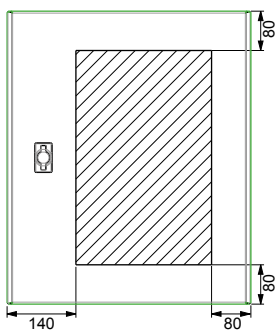

Entry flange

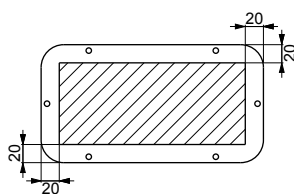

Casing

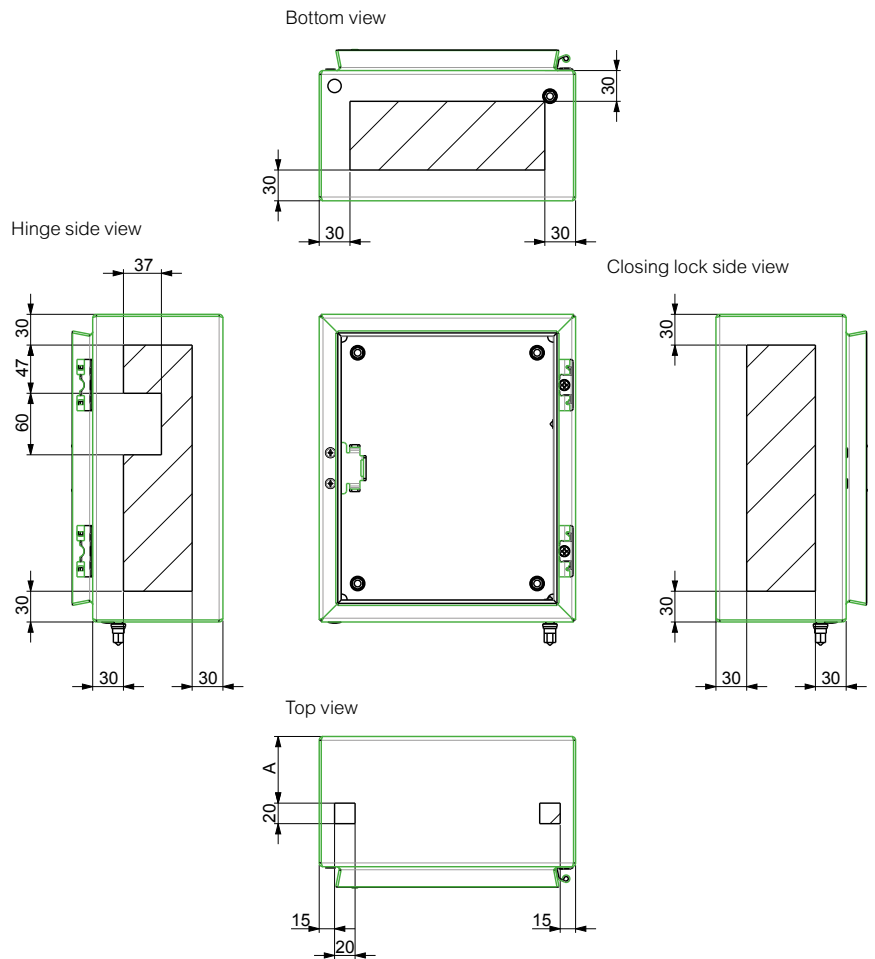

Depth mm (in.)	A mm (in.)
150 (5.91)	65 (2.56)
200 (7.87)	82 (3.23)
250 (9.84)	98 (3.86)
300 (11.81)	115 (4.53)
400 (15.75)	148 (5.83)

Note:

We meet the K3 requirements as per RCCE 2012 for the cut-outs mentioned below. These cut-outs appear in the Reference File.

Paints

AFNOR / RAL	Colors of PIA-PID 100 series	Colors of PIC 100 series
AFNOR	1550	1550
AFNOR	1570	1570
AFNOR	2550	2550
AFNOR	2570	2570
RAL	1003	1003
RAL	5005	5005
RAL	5024	5024
RAL	7036	7036

Note:
Referencing of the following paints in the FNP (national paint file):
Others colors available: Consult us.

Packaging



Note:
We can produce a special corrosion protection packaging (Gardac type).

S3D

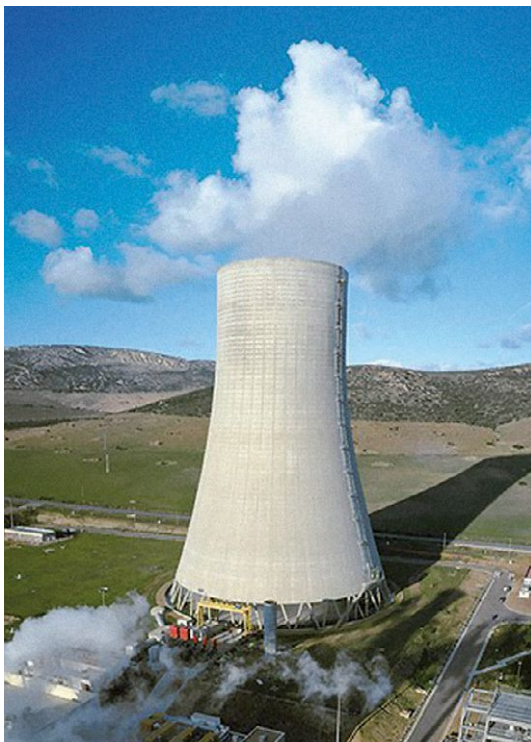

Our range of Spacial 3D nuclear enclosures meets the K3 requirements of RCCE 2012. The Schneider Electric enclosure production plant has established processes to ensure K3 certification.

Establishment of a line architecture adapted to the requirements mentioned in RCCE 2012, implying:

- Hold points;
- Check points;
- Control of "AIP" activities that are important for protection

Manufacturing completion report with:

- Declaration of conformity.
- Monitoring document.
- Report and test report.

Establishment of a Particular Quality Assurance Plan (PQAP)

Reference documents for the nuclear industry:

- RCC-E, CCTR, FNP, packaging technical specification, "PMUC" (products and materials used in nuclear generating stations), SGAQ-2013-03, Arrêté INB 2012

S3D

Nuclear safety has 3 objectives

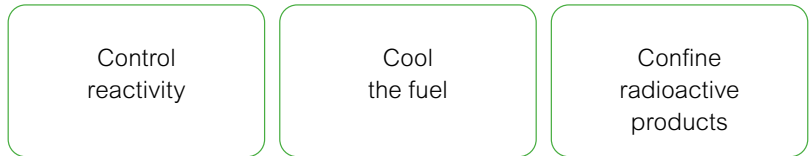

Technical choices and safety rules

The technical choices and safety rules are stipulated by the operator with full responsibility relative to the French nuclear safety authority (ASN) (representing the state) depending on the location in the installation and whether or not they form part of the safety circuits. The products undergo tests to ensure their operation in accidental conditions.

Nuclear island

Conventional island

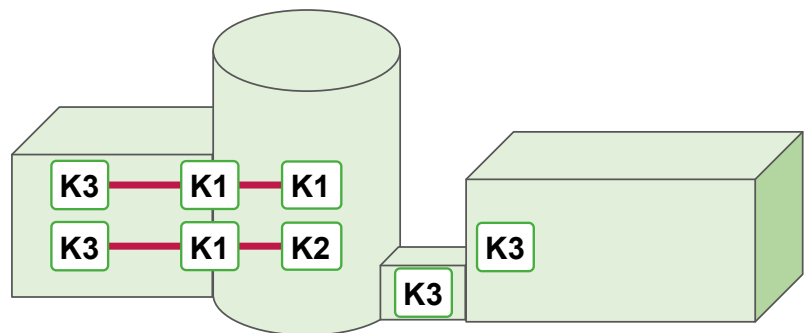

A safety circuit consists of several equipment items. Their certification depends on their location. Equipment interfacing between the core and the other buildings is always K1 (risk of radioactive leakage).

Certifications necessary to work in the nuclear industry

2 certifications are necessary to work in the nuclear industry

- 1• Product and equipment certifications imply demanding performances validated by technical documents and by tests. In the event of a change in the product, it must be explained and justified that the initial certification is maintained.
- 2• Certifications of industrial organizations and services related to products and equipment.

The products equipping French nuclear facilities in this catalog comply with the RCC-E 2012 standard.

Terminology of equipment classifications used in nuclear power stations

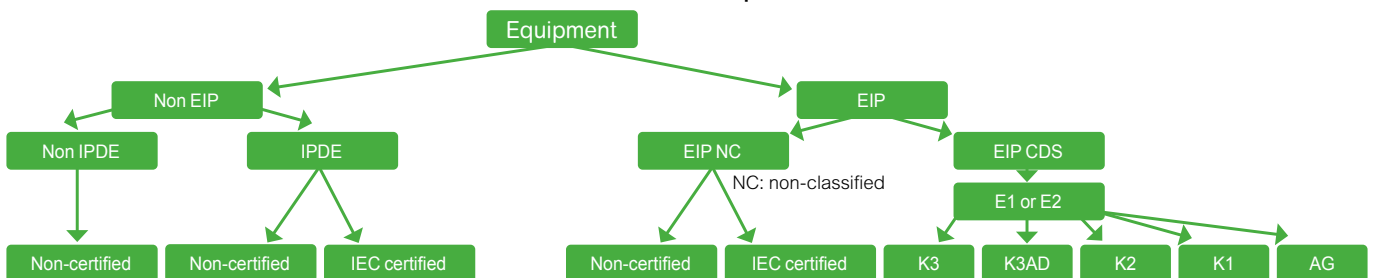

EIP: Equipment Important for Protection.
 IPDE: Important for operating availability.
 CDS: Safety-classified.
 Schneider is concerned only by E1 (elec. classification).

Tests corresponding to specific classifications for EIP equipment

- K3 > ref. tests + functional operating limits + ageing + earthquake
- K3AD > K3 + environmental resistance (irradiation, heat, spraying)
- K2 > K3 + resistance to ageing irradiation (250 Kgy)
- K1 > K2 + resistance to accidental irradiation (600 Kgy) + ADR
- AG > K1 reinforced only for EPR power stations

Spacial VDM



Spacial SF

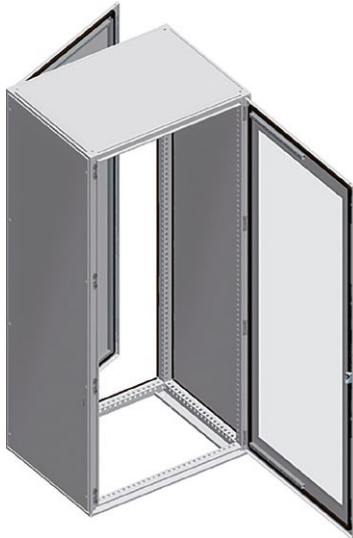

Spacial S3D



Practical

- Cable gland plates at top and bottom:
- On the rear part (2-body enclosure),
- On the body (1-body enclosure).

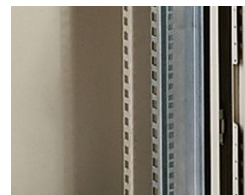

Simplified installation

- Pre-installed fixed or swing rack; Earth connection placed between the door and the body; The enclosure is ready to use; The cardboard packaging can be reused after cabling.

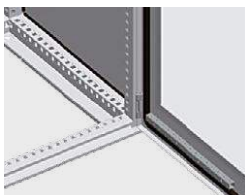

Suitable metal enclosure

- Enclosure prepared for the installation of standard 19" racks in professional telecommunication, voice, data and electronic facilities, by means of 19" fixed and swing racks, see [page 368](#).

For details consult our web site
www.se.com

Spacial VDM 19"

- Single-piece body, folded and welded.
Front rail with double sheet thickness, gutter-shaped.
- Perforated rails on the door, with drill holes of Ø 4.2 (0.16) mm (in.) in steps of 25 (0.98) mm (in.).
- Transparent door, Securit® glass, easily removable and reversible, with 20 (0.79) mm (in.) return with double thickness granting excellent rigidity, opening to 120°, equipped with 2 or 3 invisible hinges.
- Three locking system points for heights of more than 600 (23.62) mm (in.).
- Polyurethane gasket.
- 6 mm² earth connection between door and body of the enclosure.
- Material: Steel
- Finish: Structured finish, epoxi-polyester powder
- Color: RAL 7035 grey
- Ingress protection rating: IP66 according to IEC 60529
- Mechanical protection rating: IK08 according to IEC 62262

Supply:

Wall-mounted enclosure supplied with 3 (0.12) mm (in.) double-bar lock as standard

Fixed rack



NSYVDM5U4F

- Maximum load: 3 (6.61) kg (lbs.) per unit

Characteristics	Number of U	Height mm (in.)	Width mm (in.)	Depth mm (in.)	References
Fixed rack, 1-body	5	300 (11.81)	600 (23.62)	400 (15.75)	NSYVDM5U4F
Fixed rack, 1-body	8	400 (15.75)	600 (23.62)	400 (15.75)	NSYVDM8U4F
Fixed rack, 1-body	10	500 (19.68)	600 (23.62)	400 (15.75)	NSYVDM10U4F
Fixed rack, 1-body	14	700 (27.56)	600 (23.62)	400 (15.75)	NSYVDM14U4F
Fixed rack, 1-body	17	800 (31.50)	600 (23.62)	400 (15.75)	NSYVDM17U4F

Swing rack



NSYVDM4U4P

- Maximum load: 3 (6.61) kg (lbs.) per unit

Characteristics	Number of U	Height mm (in.)	Width mm (in.)	Depth mm (in.)	References
Swing rack, 1-body	4	300 (11.81)	600 (23.62)	400 (15.75)	NSYVDM4U4P
Swing rack, 1-body	7	400 (15.75)	600 (23.62)	400 (15.75)	NSYVDM7U4P
Swing rack, 1-body	9	500 (19.68)	600 (23.62)	400 (15.75)	NSYVDM9U4P
Swing rack, 1-body	13	700 (27.56)	600 (23.62)	400 (15.75)	NSYVDM13U4P
Swing rack, 1-body	16	800 (31.50)	600 (23.62)	400 (15.75)	NSYVDM16U4P

Other characteristics:

- Enclosure in 2 pieces: Body + door
- Cable gland plate at the bottom of the enclosure
- Fixed rack depth-adjustable in steps of 25 (0.98) mm (in.) using the step slides

Fixed rack



NSYVD2M5U4

- Maximum load: 2 (4.41) kg (lbs.) per unit

Characteristics	Number of U	Height mm (in.)	Width mm (in.)	Depth mm (in.)	References
Fixed rack, 2-bodies	5	300 (11.81)	600 (23.62)	380 (14.96)	NSYVD2M5U4
Fixed rack, 2-bodies	5	300 (11.81)	600 (23.62)	480 (18.90)	NSYVD2M5U5
Fixed rack, 2-bodies	8	400 (15.75)	600 (23.62)	380 (14.96)	NSYVD2M8U4
Fixed rack, 2-bodies	8	400 (15.75)	600 (23.62)	480 (18.90)	NSYVD2M8U5
Fixed rack, 2-bodies	10	500 (19.68)	600 (23.62)	380 (14.96)	NSYVD2M10U4
Fixed rack, 2-bodies	10	500 (19.68)	600 (23.62)	480 (18.90)	NSYVD2M10U5
Fixed rack, 2-bodies	14	700 (27.56)	600 (23.62)	380 (14.96)	NSYVD2M14U4
Fixed rack, 2-bodies	14	700 (27.56)	600 (23.62)	480 (18.90)	NSYVD2M14U5
Fixed rack, 2-bodies	17	800 (31.50)	600 (23.62)	380 (14.96)	NSYVD2M17U4
Fixed rack, 2-bodies	17	800 (31.50)	600 (23.62)	480 (18.90)	NSYVD2M17U5

Other characteristics:

Rear

- Depth: 150 (5.91) mm (in.)
- Internal attachment point for fixing various supports
- Hinges and locking system
- Cable gland plate at the top and bottom on the rear part

Body

- Usable depth of 183 (7.20) or 283 (11.14) mm (in.)
- Two 19" uprights made from steel, installed 65 (2.56) mm (in.) back from the front panel
- Intermediate body installed on the rear with 120° hinge

Spacial S3D empty enclosure

- Single-piece body (cross-shaped structure). Gutter-shaped front profile with double fold. Flat rear.
- Cable gland plate with marking for easy drilling and to guarantee the maximum access surface; Delivered with the enclosure. This plate is flush with the body of the enclosure.
- Glazed door, 4 (0.16) mm (in.) -thick Securit® glass, easily removable and reversible, with 20 (0.79) mm (in.) return with double thickness granting excellent rigidity, opening to 120°, equipped with 2 or 3 invisible hinges (From the height of 800 (31.50) mm (in.).)
- Material: Steel
- Finish: Structured finish, epoxy polyester powder
- Color: RAL 7035 grey
- Ingress protection rating according to IEC 60529: IP66 for the single-door enclosures, IP55 for the double-door enclosures
- Mechanical protection rating according to IEC 62262: IK10 for the plain-door enclosures, IK08 for the glazed-door enclosures
- Maximum load: 50 (110.23) kg (lbs.)/m²
- Fixing: Direct wall-mounted (4 Ø 10 (0.39) mm (in.) holes for the sealing plugs guaranteeing the IP) or with the help of fixing lugs installed from the outside (to be ordered separately, see [page 79](#))
- Other characteristics: For heights from 600 (23.62) mm (in.), three locking points with linkage, with a single control point. Simple reversal of linkage

Delivery includes a handle with two functions:

- Operating key
- Tool for loosening the stud protection caps.

This handle can be solidly attached to the locking system by means of a captive element.

Perforated rails on the door, with drill holes with a diameter of 4.2 (0.16) mm (in.) in steps of 25 (0.98) mm (in.):

- 2 vertical rails from the height of 400 (15.75) mm (in.)
- 2 vertical rails and 2 horizontal rails from the width of 800 (31.50) mm (in.)

Note:

Door opening to 180° with optional hinges ([page 68](#))

Supply:

Wall-mounted enclosure supplied with 3 (0.12) mm (in.) double-bar lock as standard

Glazed door



NSYS3D4620T

Characteristics	Fixed rack	Swing rack	Height mm (in.)	Width mm (in.)	Depth mm (in.)	References
Glazed door	NSYVDM8UF	NSYVDM7UP	400 (15.75)	600 (23.62)	200 (7.87)	NSYS3D4620T
Glazed door	NSYVDM8UF	NSYVDM7UP	400 (15.75)	600 (23.62)	250 (9.84)	NSYS3D4625T
Glazed door	NSYVDM12UF	NSYVDM11UP	600 (23.62)	600 (23.62)	200 (7.87)	NSYS3D6620T
Glazed door	NSYVDM12UF	NSYVDM11UP	600 (23.62)	600 (23.62)	250 (9.84)	NSYS3D6625T
Glazed door	NSYVDM12UF	NSYVDM11UP	600 (23.62)	600 (23.62)	300 (11.81)	NSYS3D6630T
Glazed door	NSYVDM12UF	NSYVDM11UP	600 (23.62)	600 (23.62)	400 (15.75)	NSYS3D6640T
Glazed door	NSYVDM17UF	NSYVDM16UP	800 (31.50)	600 (23.62)	200 (7.87)	NSYS3D8620T
Glazed door	NSYVDM17UF	NSYVDM16UP	800 (31.50)	600 (23.62)	250 (9.84)	NSYS3D8625T
Glazed door	NSYVDM17UF	NSYVDM16UP	800 (31.50)	600 (23.62)	300 (11.81)	NSYS3D8630T
Glazed door	NSYVDM17UF	NSYVDM16UP	800 (31.50)	600 (23.62)	400 (15.75)	NSYS3D8640T
Glazed door	NSYVDM21UF	NSYVDM20UP	1000 (39.37)	600 (23.62)	250 (9.84)	NSYS3D10625T
Glazed door	-	-	1000 (39.37)	600 (23.62)	300 (11.81)	NSYS3D10630T
Glazed door	NSYVDM21UF	NSYVDM20UP	1000 (39.37)	600 (23.62)	400 (15.75)	NSYS3D10640T
Glazed door	-	NSYVDM20U8P	1000 (39.37)	800 (31.50)	250 (9.84)	NSYS3D10825T
Glazed door	-	NSYVDM20U8P	1000 (39.37)	800 (31.50)	300 (11.81)	NSYS3D10830T
Glazed door	-	NSYVDM20U8P	1000 (39.37)	800 (31.50)	400 (15.75)	NSYS3D10840T
Glazed door	-	NSYVDM25U8P	1200 (47.24)	800 (31.50)	300 (11.81)	NSYS3D12830T
Glazed door	-	NSYVDM25U8P	1200 (47.24)	800 (31.50)	400 (15.75)	NSYS3D12840T

Plain door



NSYS3D4620

Characteristics	Fixed rack	Swing rack	Height mm (in.)	Width mm (in.)	Depth mm (in.)	References
Plain door	NSYVDM8UF	NSYVDM7UP	400 (15.75)	600 (23.62)	200 (7.87)	NSYS3D4620
Plain door	NSYVDM8UF	NSYVDM7UP	400 (15.75)	600 (23.62)	250 (9.84)	NSYS3D4625
Plain door	NSYVDM12UF	NSYVDM11UP	600 (23.62)	600 (23.62)	200 (7.87)	NSYS3D6620
Plain door	NSYVDM12UF	NSYVDM11UP	600 (23.62)	600 (23.62)	250 (9.84)	NSYS3D6625
Plain door	NSYVDM12UF	NSYVDM11UP	600 (23.62)	600 (23.62)	300 (11.81)	NSYS3D6630
Plain door	NSYVDM12UF	NSYVDM11UP	600 (23.62)	600 (23.62)	400 (15.75)	NSYS3D6640
Plain door	NSYVDM17UF	NSYVDM16UP	800 (31.50)	600 (23.62)	200 (7.87)	NSYS3D8620
Plain door	NSYVDM17UF	NSYVDM16UP	800 (31.50)	600 (23.62)	250 (9.84)	NSYS3D8625
Plain door	NSYVDM17UF	NSYVDM16UP	800 (31.50)	600 (23.62)	300 (11.81)	NSYS3D8630
Plain door	NSYVDM17UF	NSYVDM16UP	800 (31.50)	600 (23.62)	400 (15.75)	NSYS3D8640
Plain door	NSYVDM21UF	NSYVDM20UP	1000 (39.37)	600 (23.62)	250 (9.84)	NSYS3D10625
Plain door	-	-	1000 (39.37)	600 (23.62)	300 (11.81)	NSYS3D10630
Plain door	NSYVDM21UF	NSYVDM20UP	1000 (39.37)	600 (23.62)	400 (15.75)	NSYS3D10640
Plain door	-	NSYVDM20U8P	1000 (39.37)	800 (31.50)	250 (9.84)	NSYS3D10825
Plain door	-	NSYVDM20U8P	1000 (39.37)	800 (31.50)	300 (11.81)	NSYS3D10830
Plain door	-	NSYVDM20U8P	1000 (39.37)	800 (31.50)	400 (15.75)	NSYS3D10840
Plain door	-	NSYVDM25U8P	1200 (47.24)	800 (31.50)	300 (11.81)	NSYS3D12830
Plain door	-	NSYVDM25U8P	1200 (47.24)	800 (31.50)	400 (15.75)	NSYS3D12840

Spacial S3D Fixed rack (Racks to be ordered separately)

- 19" fixed chassis composed by 2 19" uprights with fixing hardware.
- Thickness: 20 (0.79)/10^e mm (in.).
- Material: Galvanized steel
- Maximum load: 3 (6.61) kg (lbs.) per unit

Note:
Adjustable in depth by fixing on the step slides in accessories (see [page 77](#)).



NSYVDM8UF

Characteristics	Number of U	Height mm (in.)	Width mm (in.)	Depth mm (in.)	References
Fixed rack	8	400 (15.75)	600 (23.62)	200 (7.87)	NSYVDM8UF
Fixed rack	8	400 (15.75)	600 (23.62)	250 (9.84)	NSYVDM8UF
Fixed rack	12	600 (23.62)	600 (23.62)	200 (7.87)	NSYVDM12UF
Fixed rack	12	600 (23.62)	600 (23.62)	250 (9.84)	NSYVDM12UF
Fixed rack	12	600 (23.62)	600 (23.62)	300 (11.81)	NSYVDM12UF
Fixed rack	12	600 (23.62)	600 (23.62)	400 (15.75)	NSYVDM12UF
Fixed rack	17	800 (31.50)	600 (23.62)	200 (7.87)	NSYVDM17UF
Fixed rack	17	800 (31.50)	600 (23.62)	250 (9.84)	NSYVDM17UF
Fixed rack	17	800 (31.50)	600 (23.62)	300 (11.81)	NSYVDM17UF
Fixed rack	17	800 (31.50)	600 (23.62)	400 (15.75)	NSYVDM17UF
Fixed rack	21	1000 (39.37)	600 (23.62)	250 (9.84)	NSYVDM21UF
Fixed rack	21	1000 (39.37)	600 (23.62)	400 (15.75)	NSYVDM21UF

Spacial S3D Swing rack (Racks to be ordered separately)

- 19" swing chassis opening to 120° with locking system by 3 (0.12) mm (in.) double-bar insert.
- Material: Steel
- Finish: Epoxy polyester powder
- Color: RAL 7035 grey
- Maximum load: 3 (6.61) kg (lbs.) per unit



NSYVDM7UP

Characteristics	Number of U	Height mm (in.)	Width mm (in.)	Depth mm (in.)	References
Swing rack	7	400 (15.75)	600 (23.62)	200 (7.87)	NSYVDM7UP
Swing rack	7	400 (15.75)	600 (23.62)	250 (9.84)	NSYVDM7UP
Swing rack	11	600 (23.62)	600 (23.62)	200 (7.87)	NSYVDM11UP
Swing rack	11	600 (23.62)	600 (23.62)	250 (9.84)	NSYVDM11UP
Swing rack	11	600 (23.62)	600 (23.62)	300 (11.81)	NSYVDM11UP
Swing rack	11	600 (23.62)	600 (23.62)	400 (15.75)	NSYVDM11UP
Swing rack	16	800 (31.50)	600 (23.62)	200 (7.87)	NSYVDM16UP
Swing rack	16	800 (31.50)	600 (23.62)	250 (9.84)	NSYVDM16UP
Swing rack	16	800 (31.50)	600 (23.62)	300 (11.81)	NSYVDM16UP
Swing rack	16	800 (31.50)	600 (23.62)	400 (15.75)	NSYVDM16UP
Swing rack	20	1000 (39.37)	600 (23.62)	250 (9.84)	NSYVDM20UP
Swing rack	20	1000 (39.37)	600 (23.62)	400 (15.75)	NSYVDM20UP
Swing rack	20	1000 (39.37)	800 (31.50)	250 (9.84)	NSYVDM20U8P
Swing rack	20	1000 (39.37)	800 (31.50)	300 (11.81)	NSYVDM20U8P
Swing rack	20	1000 (39.37)	800 (31.50)	400 (15.75)	NSYVDM20U8P
Swing rack	25	1200 (47.24)	800 (31.50)	300 (11.81)	NSYVDM25U8P
Swing rack	25	1200 (47.24)	800 (31.50)	400 (15.75)	NSYVDM25U8P

Spacial SF 19" electronic enclosure

- Structure: Top and bottom frame and vertical uprights.
- Transparent front door with Securit® glass.
- Plain rear door.
- Standard locking system with handle and 5 (0.20) mm (in.) double-bar insert.
- Removable roof.
- External fixing of double-folded side panels to increase rigidity, captive fixing screws that reduce installation time.
- In enclosures with widths of 600 (23.62) and 800 (31.50) mm (in.), it is possible to install fixed or swing racks, to be ordered separately.
- Material: Steel
- Finish: Structured finish, epoxy polyester powder
- Color: RAL 7035 grey
- Certifications: UL 508A Types 1, 12 and CUL

For more details see [page 376](#)



NSYSF12660E

Characteristics	Height mm (in.)	Width mm (in.)	Depth mm (in.)	References
Spacial SF 19" electronic enclosur	1200 (47.24)	600 (23.62)	600 (23.62)	NSYSF12660E
Spacial SF 19" electronic enclosur	1200 (47.24)	600 (23.62)	800 (31.50)	NSYSF12680E
Spacial SF 19" electronic enclosur	1200 (47.24)	800 (31.50)	600 (23.62)	NSYSF12860E
Spacial SF 19" electronic enclosur	1200 (47.24)	800 (31.50)	800 (31.50)	NSYSF12880E
Spacial SF 19" electronic enclosur	2000 (78.74)	600 (23.62)	600 (23.62)	NSYSF20660E
Spacial SF 19" electronic enclosur	2000 (78.74)	600 (23.62)	800 (31.50)	NSYSF20680E
Spacial SF 19" electronic enclosur	2000 (78.74)	800 (31.50)	600 (23.62)	NSYSF20860E
Spacial SF 19" electronic enclosur	2000 (78.74)	800 (31.50)	800 (31.50)	NSYSF20880E
Spacial SF 19" electronic enclosur	2000 (78.74)	800 (31.50)	1000 (39.37)	NSYSF208100E
Spacial SF 19" electronic enclosur	2200 (86.61)	600 (23.62)	600 (23.62)	NSYSF22660E
Spacial SF 19" electronic enclosur	2200 (86.61)	600 (23.62)	800 (31.50)	NSYSF22680E
Spacial SF 19" electronic enclosur	2200 (86.61)	600 (23.62)	1000 (39.37)	NSYSF226100E
Spacial SF 19" electronic enclosur	2200 (86.61)	800 (31.50)	600 (23.62)	NSYSF22860E
Spacial SF 19" electronic enclosur	2200 (86.61)	800 (31.50)	800 (31.50)	NSYSF22880E
Spacial SF 19" electronic enclosur	2200 (86.61)	800 (31.50)	1000 (39.37)	NSYSF228100E

Single ventilated door for 19" racks

- Door designed to achieve natural airing of the enclosure.
- Installation on enclosures with a width of 800 (31.50) mm (in.), equipped with centered fixed or swing racks. Opening of 120°.
- Standard locking system with handle and 5 (0.20) mm (in.) double-bar insert.
- Material: Steel
- Finish: Structured finish, epoxy polyester powder
- Color: RAL 7035 grey

Supply:
1 ventilated door for racks



NSYPCVD126

Characteristics	Height mm (in.)	Width mm (in.)	References
Single ventilated door	1200 (47.24)	600 (23.62)	NSYPCVD126
Single ventilated door	1200 (47.24)	800 (31.50)	NSYPCVD128
Single ventilated door	1400 (55.12)	800 (31.50)	NSYPCVD148
Single ventilated door	1600 (62.99)	800 (31.50)	NSYPCVD168
Single ventilated door	1800 (70.87)	800 (31.50)	NSYPCVD188
Single ventilated door	2000 (78.74)	600 (23.62)	NSYPCVD206
Single ventilated door	2000 (78.74)	800 (31.50)	NSYPCVD208
Single ventilated door	2200 (86.61)	600 (23.62)	NSYPCVD226
Single ventilated door	2200 (86.61)	800 (31.50)	NSYPCVD228

Front and rear plinths

- The front and rear of the plinth consists of 4 corners with 2 or 4 panels.
- Material: Folded sheet steel, corner with a thickness of 25 (0.98)/10^e mm (in.)
- Finish: Epoxy polyester paint
- Color: RAL 7022 grey
- Ingress protection rating: IP30 according to IEC 60529
- Mechanical protection rating: IK10 according to IEC 62262

Note:

For more information see [page 110](#)

Supply:

Height 100 (3.94) mm (in.): 4 corners, 2 panels (front and rear), 4 corner covers and fixing elements.
 Height 200 (7.87) mm (in.): 4 corners, 4 panels (2 front and 2 rear), 4 corner covers and fixing elements



Characteristics	Width mm (in.)	Height mm (in.)	References
Front plinths for Spacial	600 (23.62)	100 (3.94)	NSYSPF6100
Front plinths for Spacial	800 (31.50)	100 (3.94)	NSYSPF8100
Front plinths for Spacial	600 (23.62)	200 (7.87)	NSYSPF6200
Front plinths for Spacial	800 (31.50)	200 (7.87)	NSYSPF8200

Plinth side panels

- They are fixed to the corner of the plinth by 2 fixing screws.
- Folded sheet steel
- Finish: Epoxy polyester paint
- Color: RAL 7022 grey
- Ingress protection rating: IP30 according to IEC 60529
- Mechanical protection rating: IK10 according to IEC 62262

Supply:

Height 100 (3.94) mm (in.): 2 side panels, 4 corner covers and fixing elements. Height 200 (7.87) mm (in.): 4 side panels (height of 100 (3.94) mm (in.), 2 for each side), 4 corner covers and fixing elements



Characteristics	Depth mm (in.)	Height mm (in.)	References
Side plinths for Spacial	600 (23.62)	100 (3.94)	NSYSPS6100
Side plinths for Spacial	800 (31.50)	100 (3.94)	NSYSPS8100
Side plinths for Spacial	1000 (39.37)	100 (3.94)	NSYSPS10100
Side plinths for Spacial	600 (23.62)	100 (3.94)	NSYSPS6100
Side plinths for Spacial	800 (31.50)	100 (3.94)	NSYSPS8100
Side plinths for Spacial	1000 (39.37)	100 (3.94)	NSYSPS10100
Side plinths for Spacial	600 (23.62)	200 (7.87)	NSYSPS6200
Side plinths for Spacial	800 (31.50)	200 (7.87)	NSYSPS8200
Side plinths for Spacial	1000 (39.37)	200 (7.87)	NSYSPF10200
Side plinths for Spacial	600 (23.62)	200 (7.87)	NSYSPS6200
Side plinths for Spacial	800 (31.50)	200 (7.87)	NSYSPS8200
Side plinths for Spacial	1000 (39.37)	200 (7.87)	NSYSPF10200

Ventilated front plinth

- The front and rear of the ventilated plinth is made up of 4 corners with 2 front panels.
- Material: Folded sheet steel, corner with a thickness of 25 (0.98)/10° mm (in.)
- Finish: Structured finish, epoxy polyester powder
- Color: RAL 7022 grey
- Ingress protection rating: IP20 according to IEC 60529
- Mechanical protection rating: IK10 according to IEC 62262



NSYSPFV6100

Supply:
Height 100 (3.94) mm (in.): 4 corners, 2 ventilated panels (front and rear), 4 corner covers and fixing elements

Characteristics	Height mm (in.)	Width mm (in.)	References
Ventilated front plinth for Spacial SF-SM	100 (3.94)	600 (23.62)	NSYSPFV6100
Ventilated front plinth for Spacial SF-SM	100 (3.94)	800 (31.50)	NSYSPFV8100

Ventilated side panels

- They are fixed to the corner of the plinth by fixing screws.
- Material: Folded sheet steel
- Finish: Structured finish, epoxy polyester powder
- Color: RAL 7022 grey
- Ingress protection rating: IP20 according to IEC 60529
- Mechanical protection rating: IK10 according to IEC 62262



NSYSPV6100

Supply:
Height 100 (3.94) mm (in.): 2 ventilated side panels, 4 corner covers and fixing elements

Characteristics	Height mm (in.)	Depth mm (in.)	References
Ventilated side panels for Spacial SF-SM	100 (3.94)	600 (23.62)	NSYSPV6100
Ventilated side panels for Spacial SF-SM	100 (3.94)	800 (31.50)	NSYSPV8100

Plain cable gland plate

- The design of the compact cable gland plate, coupled with the use of the sealing gasket **NSYCEK** enable the maximum dust/water tightness.
- Material: Galvanized steel
- Thicknesses: 15 (0.59)/10° mm (in.)



NSYEC66

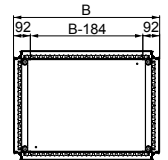

Supply:
Plain plate and fixing elements

Characteristics	(B) Width mm (in.)	(C) Depth mm (in.)	References
Spacial SF Plain cable gland plate	600 (23.62)	600 (23.62)	NSYEC66
Spacial SF Plain cable gland plate	600 (23.62)	800 (31.50)	NSYEC68
Spacial SF Plain cable gland plate	600 (23.62)	1000 (39.37)	NSYEC610
Spacial SF Plain cable gland plate	800 (31.50)	600 (23.62)	NSYEC86
Spacial SF Plain cable gland plate	800 (31.50)	800 (31.50)	NSYEC88
Spacial SF Plain cable gland plate	800 (31.50)	1000 (39.37)	NSYEC810

Plate with 1 entry

- Facilitates the entry of cables thanks to a longitudinal opening.
- Material: Galvanized steel
- Thicknesses: 15 (0.59)/10° mm (in.)



NSYEC661

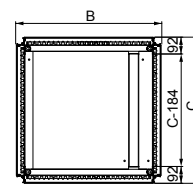

Enclosures of 300 and 400 mm width.

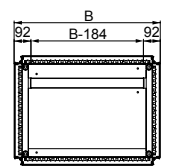

Enclosures of 600, 800, 1000 and 1200 mm width.

Supply:
Plate with 1 entry; Self-extinguishing polyurethane adhesive gasket with cross-section of 15 (0.59) x 25 (0.98) mm (in.) (guarantees good sealing) and fixing elements

Characteristics	(B) Width mm (in.)	(C) Depth mm (in.)	References
Spacial SF Plate with 1 entry	600 (23.62)	600 (23.62)	NSYEC661
Spacial SF Plate with 1 entry	600 (23.62)	800 (31.50)	NSYEC681
Spacial SF Plate with 1 entry	600 (23.62)	1000 (39.37)	NSYEC6101
Spacial SF Plate with 1 entry	800 (31.50)	600 (23.62)	NSYEC861
Spacial SF Plate with 1 entry	800 (31.50)	800 (31.50)	NSYEC881
Spacial SF Plate with 1 entry	800 (31.50)	1000 (39.37)	NSYEC8101

Plate with 2 entries

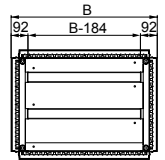

- Cable entry for very deep enclosures (600 (23.62) and 800 (31.50) mm (in.)).
- Two longitudinal openings allowing a large number of cables through.
- Material: Galvanized steel
- Thicknesses: 15 (0.59)/10^ø mm (in.)

Supply:

1 plate with 2 entries; Polyurethane adhesiv gasket with cross-section of 15 (0.59) x 25 (0.98) mm (in.) (guarantee good sealing) and fixing elements



NSYEC662

Characteristics	(B) Width mm (in.)	(C) Depth mm (in.)	References
Spacial SF Plate with 2 entries	600 (23.62)	600 (23.62)	NSYEC662
Spacial SF Plate with 2 entries	600 (23.62)	800 (31.50)	NSYEC682
Spacial SF Plate with 2 entries	600 (23.62)	1000 (39.37)	NSYEC6102
Spacial SF Plate with 2 entries	800 (31.50)	600 (23.62)	NSYEC862
Spacial SF Plate with 2 entries	800 (31.50)	800 (31.50)	NSYEC882
Spacial SF Plate with 2 entries	800 (31.50)	1000 (39.37)	NSYEC8102

Actassi plain plate for roof

- Removable plate made from folded sheet steel, to be installed on roof ref. **NSYSRSYS8•**.
- Option of installing roof elevators for aeration, ref. **NSYEX206**, and cable glands.
- Material: Steel
- Finish: Structured finish, epoxy polyester powder
- Color: RAL 7035 grey

Supply:
1 plain plate and fixing elements

Characteristics

Actassi plain plate for roof

References

NSYTSPC450



NSYTSPC450

Actassi plate with brush gasket for roof

- Removable folded sheet steel plate, equipped with a gasket with cable gland brush, to be installed on roof ref. **NSYSRSYS8•**.
- Optional installation of roof elevators for aeration, ref. **NSYEX206**, and cable gland plates.
- Material: Steel
- Finish: Structured finish, epoxy polyester powder
- Color: RAL 7035 grey

Supply:
1 plate with brush gasket and fixing elements

Characteristics

Actassi plate with brush gasket for roof

References

NSYTSP450



NSYTSP450

Actassi ventilated plate for roof

- Removable plate made from folded sheet steel, to be installed on roof ref. **NSYSRSYS8•**.
- Optional installation of roof elevators for aeration, ref. **NSYEX206**, cable gland plates and fans.
- Material: Steel
- Finish: Structured finish, epoxy polyester powder
- Color: RAL 7035 grey

Supply:
1 ventilated plate and fixing elements

Characteristics

Actassi ventilated plate for roof

References

NSYTSPV450



NSYTSPV450

Roof plate elevators for aeration

- Columns with a height of 20 (0.79) mm (in.).
- Fixing: Between the roofplate and the roof.

Supply:
100 units. Reference by unit.
Order by multiples of 100 (100, 200, 300...).

Characteristics

Roof plate elevators for aeration

References

NSYEX206



NSYEX206

Actassi plain cable gland plate

- Material: Galvanized steel
- Fixing: Fixing on the outside of the roof and bottom support plate
Can be combined with other types of cable gland plates

For more details see [page 376](#)

Supply:
1 plain cable gland plate and fixing elements



NSYEC440

Characteristics	References
Actassi plain cable gland plate	NSYEC440

Actassi cable gland plate with brush

- Material: Galvanized steel
- Fixing: Fixing on the outside of the roof and bottom support plate
Can be combined with other types of cable gland plates

Supply:
1 cable gland plate with brush and fixing elements



NSYEC440

Characteristics	References
Actassi cable gland plate with brush	NSYEC440

Actassi self-ventilated cable gland plate

- Material: Galvanized steel
- Fixing: Fixing on the outside of the roof and bottom support plate
Can be combined with other types of cable gland plates

Supply:
1 self-ventilated cable gland plate and fixing elements



NSYEC440

Characteristics	References
Actassi self-ventilated cable gland plate	NSYEC440

Actassi airing plate with or without fans, symbol diameter before 120 (4.72) mm (in.)

- Fixing: Fixing on the outside of the roof and bottom support plate
Can be combined with other types of cable gland plates
- Other characteristics: Sound level: 34 dB (A)

Supply:
1 cable gland plate with or without fans, 2 (78.74) m (in.) power cord (version with fans) and fixing elements
Versions with 2 or 3 fans: Each of them has an output capacity of 170 m³/h (100.06 ft³/min), 220 V-50/60 Hz, installed and wired to a terminal strip. A 2-m power cord is supplied connected



NSYECVT3440

Characteristics	Description	References
Actassi airing plate with or without fans, symbol diameter before 120 (4.72) mm (in.)	No fans, 3 positions	NSYECVT3440
Actassi airing plate with or without fans, symbol diameter before 120 (4.72) mm (in.)	With 3 fans	NSYECVT3V440
Actassi airing plate with or without fans, symbol diameter before 120 (4.72) mm (in.)	No fans, 2 positions	NSYECVT2440
Actassi airing plate with or without fans, symbol diameter before 120 (4.72) mm (in.)	With 2 fans	NSYECVT2V440

Actassi ventilated support with filter

- Fixing: To be mounted on the cable gland plate with or without fan or on the self-ventilated cable gland plate.
- Color: RAL 9011

Supply:
1 mounting support and filter



NSYFECVT440

Characteristics	References
Actassi ventilated support with filter	NSYFECVT440

Spare filter for Actassi ventilated support

Supply:
5 units



NSYCEFILS

Characteristics	References
Spare filter for Actassi ventilated support	NSYCEFILS

Ventilated roof

- Roof for providing natural airing for the enclosure, with IP30 protection.
- Height: An extra 63 (2.48) mm (in.) in relation to the structure.
- Material: Steel
- Finish: Structured finish, epoxy polyester powder
- Color: RAL 7035 grey

For more details see [page 376](#)

Supply:
1 ventilated roof and fixing elements



NSYSVR606

Characteristics	Width mm (in.)	Depth mm (in.)	References
Spacial SF Ventilated roof	600 (23.62)	600 (23.62)	NSYSVR606
Spacial SF Ventilated roof	600 (23.62)	800 (31.50)	NSYSVR608
Spacial SF Ventilated roof	800 (31.50)	600 (23.62)	NSYSVR806
Spacial SF Ventilated roof	800 (31.50)	800 (31.50)	NSYSVR808

Partial 19" fixed rack

- Rack designed for coupling in enclosures with a width of 600 (23.62) mm (in.).
- Adjustable depth with a pitch of 25 (0.98) mm (in.).
- Material: Zinc-coated steel
- Maximum load: 2 (4.41) kg (lbs.)/U

Installation:

Spacial SF:

- Installation at the top front of the enclosure, no cross-rails needed ⁽¹⁾
- Depth adjustment of the partial rack:
two cross-rails need to be installed, see [page 255](#)
- For installation at any other height, four cross-rails are required ⁽²⁾

Spacial SM:

- At the front of the enclosure ⁽¹⁾: Install two front vertical adaptation profiles, see [page 258](#)
- For depth adjustment ⁽²⁾: Install two front vertical adaptation profiles, see [page 258](#) and two rear vertical 40 (1.58) mm (in.) (1 row) cross-rails and four cross-rails, see [page 255](#)

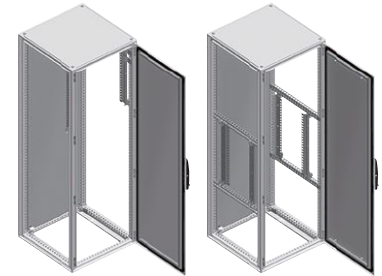

(1)

(2)

Supply:
2 uprights and fixing elements

Characteristics	No. of units	Height mm (in.)	References
Partial 19" fixed rack	4	200 (7.87)	NSYRCKP4
Partial 19" fixed rack	8	400 (15.75)	NSYRCKP8
Partial 19" fixed rack	12	600 (23.62)	NSYRCKP12
Partial 19" fixed rack	17	800 (31.50)	NSYRCKP17
Partial 19" fixed rack	21	1000 (39.37)	NSYRCKP21
Partial 19" fixed rack	26	1200 (47.24)	NSYRCKP26



NSYRCKP4

19" fixed rack

- Rack designed for installation in enclosures with a width of 600 (23.62) mm (in.).
- Adjustable depth with a pitch of 25 (0.98) mm (in.).
- Material: Zinc-coated steel
- Maximum load: 400 (881,85) kg (lbs.) for 4 uprights
- Maximum load: 200 (440,93) kg (lbs.) for 2 uprights

Installation:

Spacial SF:

- Direct fixing on the structure of the enclosures:
- For installation on enclosures with a width of 800 (31.50) mm (in.), use the 19" fixed-rack support brackets,
- To reinforce the rigidity of the uprights in enclosures with a width of 800 (31.50) mm (in.), it is advisable to use the central fixing kit, for enclosure heights above 1800 (70.87) mm (in.), ref. **NSYRCK19KIT**.

Spacial SM:

- Fixing on the top/bottom adjustment rails.

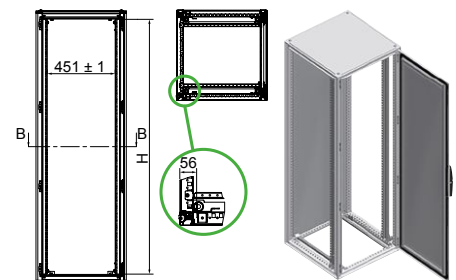

Supply:
2 uprights and fixing elements

Characteristics	No. of units	Height mm (in.)	References
19" fixed rack	24	1200 (47.24)	NSYRCK24
19" fixed rack	29	1400 (55.12)	NSYRCK29
19" fixed rack	33	1600 (62.99)	NSYRCK33
19" fixed rack	38	1800 (70.87)	NSYRCK38
19" fixed rack	42	2000 (78.74)	NSYRCK42
19" fixed rack	47	2200 (86.61)	NSYRCK47

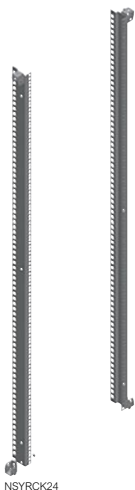

NSYRCK24

Support brackets for 19" fixed rack with a width of 800 (31.50) mm (in.)

- Support brackets for coupling the fixed rack to enclosures with a width of more than 600 (23.62) mm (in.).
- They allow the depth of the fixed rack to be adjusted with a pitch of 25 (0.98) mm (in.).
- The fixed sizes are delivered in pairs.
- Material: Zinc-coated steel
- Maximum load: 400 (881.85) kg (lbs.)

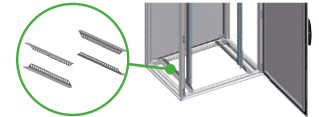

Supply:
4 support brackets and fixing elements



NSYRCKS6

Characteristics	Depth mm (in.)	References
Support brackets for 19" fixed rack	600 (23.62)	NSYRCKS6
Support brackets for 19" fixed rack	800 (31.50)	NSYRCKS8
Support brackets for 19" fixed rack	1000 (39.37)	NSYRCKS10

Side plates of the centered fixed rack for a width of 800 (31.50) mm (in.)

- Side plates for coupling to the fixed rack in enclosures with a width of 800 (31.50) mm (in.).
- Direct installation on the rack by screws.
- The fixed sizes are delivered in pairs.
- Material: Steel
- Finish: Structured finish, epoxy polyester powder
- Color: RAL 7035 grey



Supply:
2 side plates and fixing elements



NSYRC12

Characteristics	Height mm (in.)	References
Side plates of the centered fixed rack	1200 (47.24)	NSYRC12
Side plates of the centered fixed rack	1400 (55.12)	NSYRC14
Side plates of the centered fixed rack	1600 (62.99)	NSYRC16
Side plates of the centered fixed rack	1800 (70.87)	NSYRC18
Side plates of the centered fixed rack	2000 (78.74)	NSYRC20
Side plates of the centered fixed rack	2200 (86.61)	NSYRC22

Central fixing kit

- To reinforce the rigidity of the 19" fixed racks in enclosures with a width of 800 (31.50) mm (in.).
- Fixing to the enclosure by cross-rails or light cross-rails installed depthwise. See [page 256](#).
- Material: Zinc-coated steel

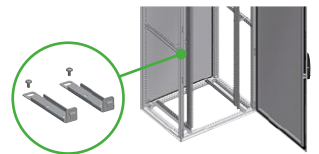

Supply:
2 supports and fixing elements



NSYRCK19KIT

Characteristics	References
Central fixing kit	NSYRCK19KIT

Partial 19" swing rack for 600 (23.62) and 800 (31.50) mm (in.) enclosures

- Rack for coupling to enclosures with widths of 600 (23.62) and 800 (31.50) mm (in.).
- In enclosures with a width of 800 (31.50) mm (in.), the rack can be installed centered or off-center.
- Maximum opening: 120°.
- Reversible opening direction: Left/right.
- Locking system, top and bottom, with 5 (0.20) mm (in.) double-bar key.
- The 6 and 9 units racks only with bottom lock.
- Maximum equipment installation depth: 180 (7.09) mm (in.), in enclosures with a width of 600 (23.62) mm (in.).
- Material: Zinc-coated steel

Installation:

Spacial SF:

- To install at the front at any height of the enclosure: directly to the framework by rack fixing elements
- For depth adjustment: Install two (for top height) or four (for any height) 65 (2.56) mm (in.) (2 rows) cross-rails, see [page 255](#)

Spacial SM:

- To install at the front at any height of the enclosure: install two front vertical adaptation profiles, see [page 258](#)
- For depth adjustment: Install two front vertical adaptation profiles, see [page 258](#) and two rear vertical 40 (1.58) mm (in.) cross-rails and four 65 (2.56) mm (in.) (2 rows) cross-rails, see [page 255](#)
- Maximum load: 2 (4.41) kg (lbs.)/U

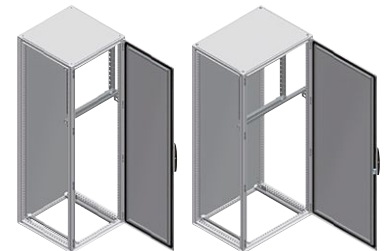

For more details see [page 376](#)

⁽¹⁾ Optional installation in enclosures with height of 1200 (47.24) mm (in.).

Supply:

1 partial 19" swing rack



NSYRSWP6

Characteristics	No. of units (H)	Height mm (in.)	References
Partial 19" swing rack	6	355 (13.98)	NSYRSWP6
Partial 19" swing rack	9	468 (18.42)	NSYRSWP9
Partial 19" swing rack	12	601 (23.66)	NSYRSWP12
Partial 19" swing rack	15	735 (28.94)	NSYRSWP15
Partial 19" swing rack	18	868 (34.17)	NSYRSWP18
Partial 19" swing rack ⁽¹⁾	21	1002 (39.45)	NSYRSWP21

Partial 19" swing rack support for 600 (23.62) and 800 (31.50) mm (in.) enclosures

- Supports for coupling the partial swing rack to enclosures with widths of 600 (23.62) and 800 (31.50) mm (in.).
- Height or depth adjustment, with a pitch of 25 (0.98) mm (in.), by two 65 (2.56) mm (in.) (2 rows) universal cross-rails and a 19" multiple bracket, ref. **NSYMBR19**.
- Spacial SF: Direct fixing to the structure.
- Spacial SM: Fixing to the enclosure by means of the vertical adaptation profile, see [page 258](#).
- Material: Zinc-coated steel

Installation:

- Installation of the rack in centered or off-center position, for enclosures with a width of 800 (31.50) mm (in.)

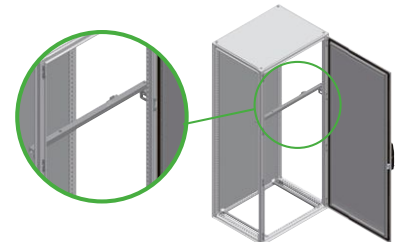

Supply:

2 supports and fixing elements



NSYRSWSP6

Characteristics	Width mm (in.)	References
Partial 19" swing rack support	600 (23.62)	NSYRSWSP6
Partial 19" swing rack support	800 (31.50)	NSYRSWSP8

19" multiple bracket

- Bracket for fixing 65 (2.56) mm (in.) universal cross-rails (2 rows), depthwise, to position the partial 19" swing rack in any direction, up and down and/or depthwise.
- Material: Zinc-coated steel.

Supply:

4 brackets and fixing elements



NSYMBR19

Characteristics	Width mm (in.)	References
19" multiple bracket	600 (23.62)	NSYMBR19

19" swing rack for 600 (23.62) mm (in.) enclosures

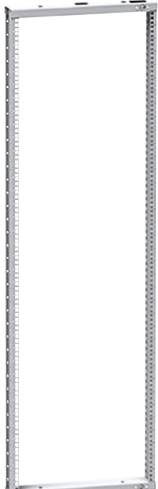

NSYRSW627

- To be coupled to enclosures with widths of 600 (23.62) mm (in.).
- Can be moved depthwise with a pitch of 25 (0.98) mm (in.).
- Reversible opening direction: Left/right.
- Locking system, top and bottom, with 5 (0.20) mm (in.) double-bar key.
- Maximum opening: 130°.
- Maximum equipment installation depth: 180 (7.09) mm (in.).
- Not compatible with 120° mechanical retainer **NSYRCDR12**

Fixing to the enclosure structure:

Spacial SF:

- Fixing to the enclosure structure.

Spacial SM:

- Fixing to the enclosure on top/bottom adjustment rails.

Components:

- Zinc-coated steel central structure.
- Mounting cross-rail on structure made from steel painted with epoxy polyester resin, textured RAL 7035 grey. Fixed to the central structure by screws.

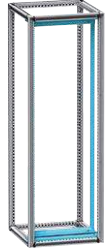

For more details see [page 376](#)

Supply:

1 19" swing rack with no panels

Characteristics	No. of units (H)	Height mm (in.)	References
19" swing rack	27	1400 (55.12)	NSYRSW627
19" swing rack	31	1600 (62.99)	NSYRSW631
19" swing rack	36	1800 (70.87)	NSYRSW636
19" swing rack	40	2000 (78.74)	NSYRSW640
19" swing rack	45	2200 (86.61)	NSYRSW645

19" swing rack for 800 (31.50) mm (in.) enclosures, off-center



NSYRSW27

- To be coupled to enclosures with widths of 800 (31.50) mm (in.).
- Can be moved depthwise with a pitch of 25 (0.98) mm (in.).
- Reversible opening direction: Left/right.
- Locking system, top and bottom, with 5 (0.20) mm (in.) double-bar key.
- Maximum opening: 130° (option of opening to 180° using 180° hinges).
- Material: Zinc-coated steel and steel painted
- Maximum load: 3.75 (8.27) kg (lbs./unit with a max of 150 (330.69) kg (lbs.)

Installation:

- Spacial SF - SM
- Other mounting options: Consult us

Maximum equipment installation depth:

- Off-center 19" swing rack: 470 (18.50) mm (in.)
- Centered 19" swing rack: 390 (15.35) mm (in.)

Fixing to the enclosure structure:

- Spacial SF: Fixing to the entire height of the enclosure structure.
- Spacial SM: Fixing to the enclosure on top/bottom adjustment rails.

Components:

- Zinc-coated steel central structure.
- Mounting cross-rail on structure made from steel painted with epoxy polyester resin, textured RAL 7035 grey.
- Fixed to the central structure by screws.
- Side plate made from steel painted with epoxy polyester resin, textured RAL 7035 grey. Fixed to the central structure by screws.

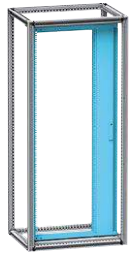

For more details see [page 376](#)

Supply:

Centered and off-center 19" swing rack: hinged rack, 800 (31.50) mm (in.) swing rack supports, side plates with locking system double-bar and fixing elements

Characteristics	No. of units (H)	Height mm (in.)	References
19" swing rack, off-center	27	1400 (55.12)	NSYRSW27
19" swing rack, off-center	31	1600 (62.99)	NSYRSW31
19" swing rack, off-center	36	1800 (70.87)	NSYRSW36
19" swing rack, off-center	40	2000 (78.74)	NSYRSW40
19" swing rack, off-center	45	2200 (86.61)	NSYRSW45

19" swing rack for 800 (31.50) mm (in.) enclosures, centered

- To be coupled to enclosures with widths of 800 (31.50) mm (in.).
- Can be moved depthwise with a pitch of 25 (0.98) mm (in.).
- Reversible opening direction: Left/right.
- Locking system, top and bottom, with 5 (0.20) mm (in.) double-bar key.
- Maximum opening: 130° (option of opening to 180° using 180° hinges).
- Material: Zinc-coated steel and steel painted
- Maximum load: 3.75 (8.27) kg (lbs./unit with a max of 150 (330.69) kg (lbs.)

Installation:

- Spacial SF - SM
- Other mounting options: Consult us

Maximum equipment installation depth:

- Off-center 19" swing rack: 470 (18.50) mm (in.)
- Centered 19" swing rack: 390 (15.35) mm (in.)

Fixing to the enclosure structure:

- Spacial SF: Fixing to the entire height of the enclosure structure.
- Spacial SM: Fixing to the enclosure on top/bottom adjustment rails.

Components:

- Zinc-coated steel central structure.
- Mounting cross-rail on structure made from steel painted with epoxy polyester resin, textured RAL 7035 grey.
- Fixed to the central structure by screws.
- Side plate made from steel painted with epoxy polyester resin, textured RAL 7035 grey. Fixed to the central structure by screws.

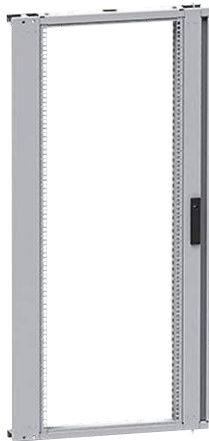

NSYRSWC27

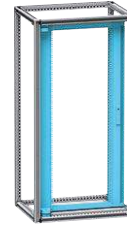

For more details see [page 376](#)

Supply:

Centered and off-center 19" swing rack: hinged rack, 800 (31.50) mm (in.) swing rack supports, side plates with locking system double-bar and fixing elements

Characteristics	No. of units (H)	Height mm (in.)	References
19" swing rack, centered	27	1400 (55.12)	NSYRSWC27
19" swing rack, centered	31	1600 (62.99)	NSYRSWC31
19" swing rack, centered	36	1800 (70.87)	NSYRSWC36
19" swing rack, centered	40	2000 (78.74)	NSYRSWC40
19" swing rack, centered	45	2200 (86.61)	NSYRSWC45

180° hinge

- Hinge for installation on centered and off-center 19" swing racks.
- Allows the swing rack to be opened to 180°.
- Fixing by M8 screws directly to the swing rack.
- Material: Zamak 5

Maximum equipment installation depth:

- Off-center 19" swing rack: 425 (16.73) mm (in.),
- Centered 19" swing rack: 345 (13.58) mm (in.).



NSYRSWH180

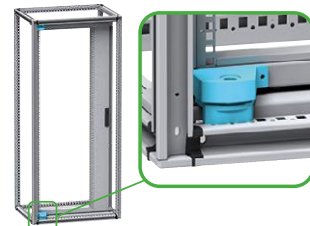

Supply:

2 hinges and fixing elements

Characteristics	References
180° hinge	NSYRSWH180

1 U / 3 U support

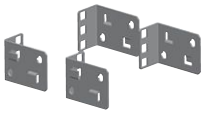

NSYRC1U

- Support prepared for installing equipment 1 U or 3 U high.
- Designed with quick-locking for easy installation.
- **Spacial SF:** Direct fixing to the structure.
- **Spacial SM:** Fixing to the enclosure by means of the vertical adapter section, see [page 258](#).
- Material Zinc-coated steel

Characteristics	References
1 U / 3 U support	NSYRC1U

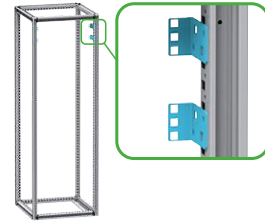

For more details see [page 376](#)

Supply:
4 1 U/3 U supports (2 units right and 2 units left) and fixing elements

19" partial single slides



NSYGB140

- Rails for installation on fixed or swing racks.
- Direct fixing on the structure of the enclosure, by quick-locking.
- Material: Zinc-coated steel
- Thickness: 12 (0.47)/10^a mm (in.)
- Maximum load: 15 (33.07) kg (lbs.)

Characteristics	References
19" partial single slides	NSYGB140

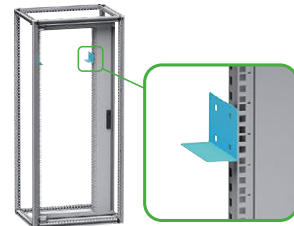

Supply:
2 rails and fixing elements

Fixing of cable ducts on 19" racks



NSYRCDFIX

- Allows vertical fixing of cable ducts for cable guide.
- Service depth: 150 (5.91) mm (in.).
- Fixed by quick-locking to the 19" rack profile.
- Material: Zinc-coated steel

Characteristics	References
Fixing of cable ducts on 19" racks	NSYRCDFIX

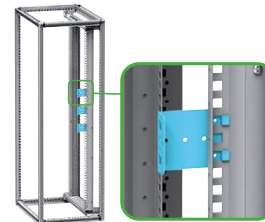

Supply:
3 units and fixing elements

Rear cable-guide support



NSYRCSUP15

- Supports used for installation on the rear of the swing racks.
- Suitable for fixing cable-guide accessories.
- Allow vertical fixing of cable ducts: Adjustable depth with a pitch of 44.45 (1.75) mm (in.).
- Material: Z \neq steel

Characteristics	Service depth mm (in.)	References
Rear cable-guide support	150 (5.91)	NSYRCSUP15
Rear cable-guide support	250 (9.84)	NSYRCSUP25

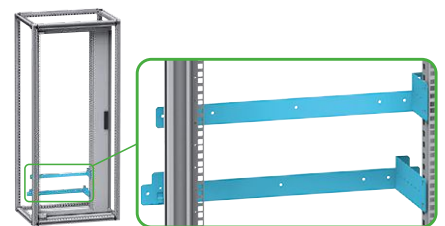

Supply:
2 cable-guide supports, crossbar and fixing elements

120° mechanical retainer

- Retainer for installation on the swing racks.
- Maximum opening: 120°.
- Not compatible with the 19" swing racks for 600 (23.62) mm (in.) enclosures (NSYRSW6*)

Fixing:

Direct fixing to the rack support and the 19" rack

Supply:

1 mechanical door stop and fixing elements



NSYRCDR12

Characteristics	References
120° mechanical retainer	NSYRCDR12

180° pneumatic retainer

- Retainer for installation on the swing racks installed with 180° hinges, in enclosures with a depth of 600 (23.62), 800 (31.50) or 1000 (39.37) mm (in.).
- Maximum opening: 180°.

Fixing:

Spacial SF:

Fixing to the base of the structure and to the rack.

Spacial SM:

Direct fixing to the rack support and to the 19" rack.

Supply:

1 pneumatic door stop and fixing elements



NSYRCDR18

Characteristics	References
180° pneumatic retainer	NSYRCDR18

Switch for swing 19" rack

- Switch for direct fixing on the bottom or top support of the swing rack.
- M20 connection.
- NO + NC contact, 10 A/500 V.

Supply:

1 19" rack switch and fixing elements



NSYRCINT

Characteristics	References
Switch for swing 19" rack	NSYRCINT

Fixings for 19" rack

- They allow 19" accessories to be mounted.
- Caged nut compatible with 8.5 (0.34) x 8.5 (0.34) mm (in.) and 9.5 (0.37) x 9.5 (0.37) mm (in.) holes.



NSYGFR95M63

Characteristics	Set of	References
M6 screws + washers + nuts	30	NSYGFR95M63
M6 x 16 screws and washers	50	NSYGFR166P
M6 caged nuts	100	NSYCN9M625
M6 screws + washers + nuts	50	NSYGFR95M65
M5 screws + washers + nuts	50	NSYGFR95M55

1-body 19" enclosure

Fixed chassis

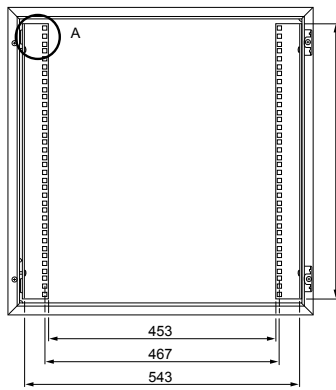

Swing chassis

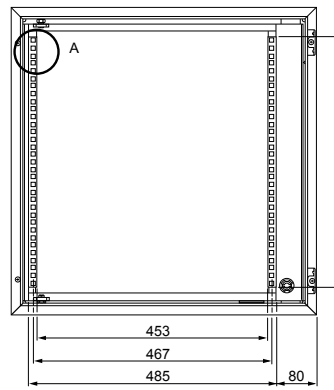

Fixed chassis mounted on the step slides

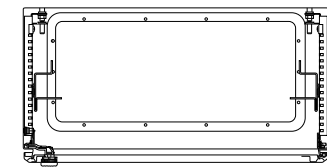
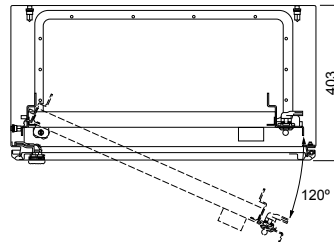
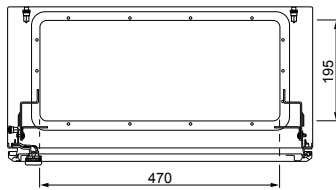
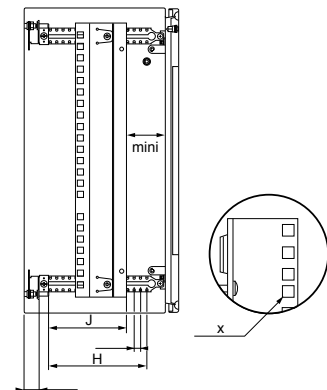

Cable gland plate 495 (19.49) x 220 (8.66) mm (in.).

H (bars) mm (in.)	J (travel) mm (in.)
200 (7.87)	100 (3.94)
250 (9.84)	150 (5.91)
300 (11.81)	200 (7.87)
400 (15.75)	300 (11.81)

Double-body 19" enclosure

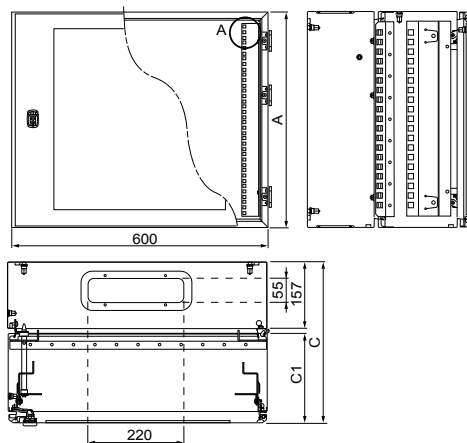

A mm (in.)	C mm (in.)	C1 mm (in.)	References
300 (11.81)	373 (14.68)	183 (7.20)	NSYVD2M5U4
400 (15.75)	373 (14.68)	183 (7.20)	NSYVD2M5U5
500 (19.68)	373 (14.68)	183 (7.20)	NSYVD2M8U4
700 (27.56)	373 (14.68)	183 (7.20)	NSYVD2M8U5
800 (31.50)	373 (14.68)	183 (7.20)	NSYVD2M10U4
300 (11.81)	473 (18.62)	283 (11.14)	NSYVD2M10U5
400 (15.75)	473 (18.62)	283 (11.14)	NSYVD2M14U4
500 (19.68)	473 (18.62)	283 (11.14)	NSYVD2M14U5
700 (27.56)	473 (18.62)	283 (11.14)	NSYVD2M17U4
800 (31.50)	473 (18.62)	283 (11.14)	NSYVD2M17U5

Cable gland plate S3D type dimensions 245 (9.65) x 80 (3.15) mm (in.).

Ventilated roof

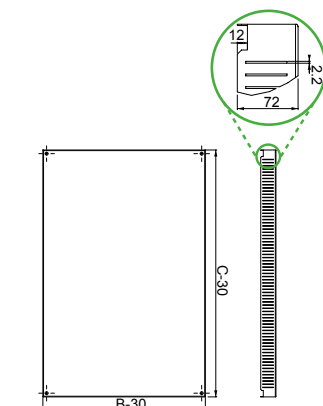

Examples of possible combinations

Cable gland plates for the roof

Spacial SF dimensions		Combination 1	Combination 2
Width mm (in.)	Depth mm (in.)		
600 (23.62) / 800 (31.50)	600 (23.62)		
600 (23.62) / 800 (31.50)	800 (31.50)		
600 (23.62) / 800 (31.50)	1000 (39.37)		

Spacial SF 19" electronic enclosure

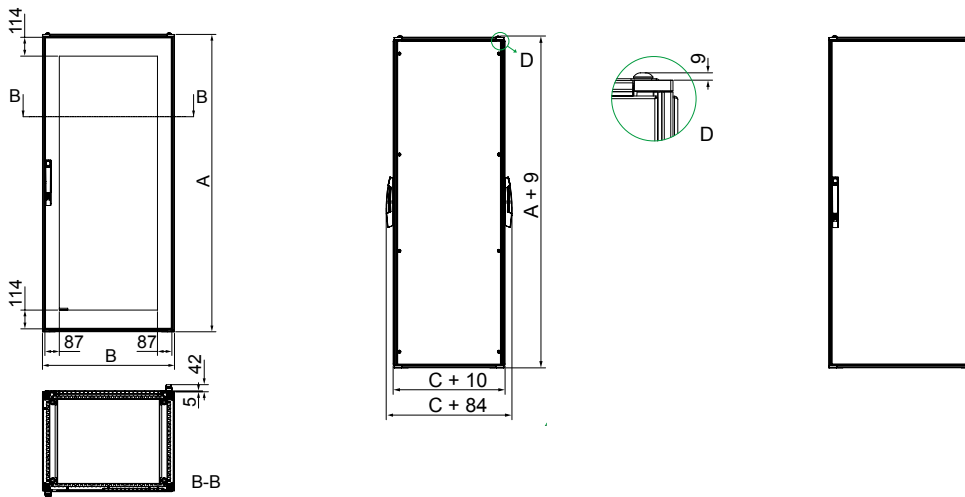

Partial 19" swing rack for 600 (23.62) and 800 (31.50) mm (in.) enclosures

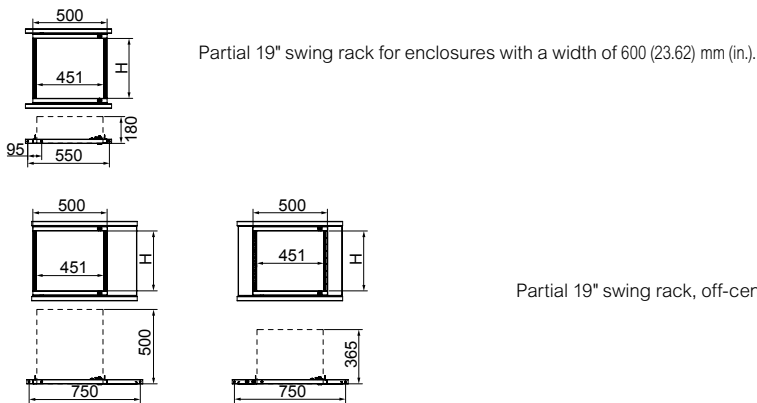

19" swing rack for 600 (23.62) mm (in.) enclosures

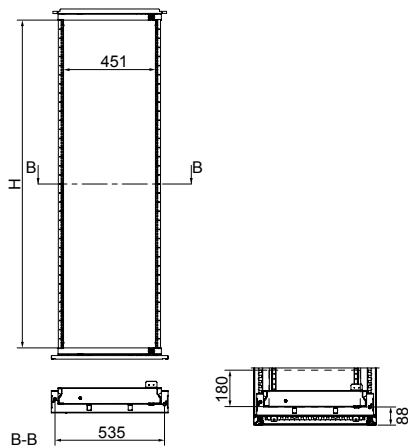

19" swing racks for 800 (31.50) mm (in.) enclosures

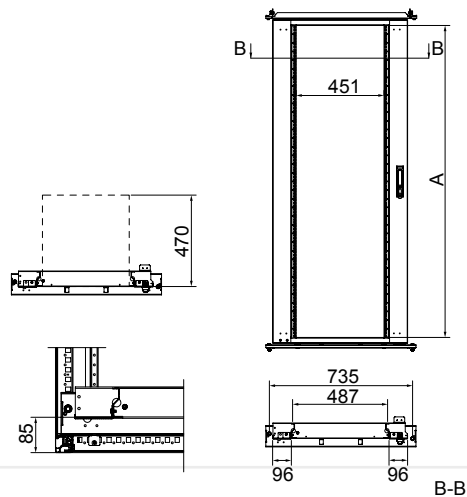

1 U / 3 U support

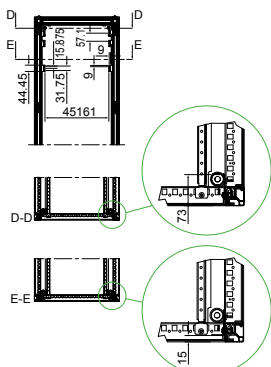

Technical changes reserved. Information provided without guarantee. Images are for illustrative purposes only.

EcoStruxure™ Micro Data Center for Rugged Environments

Spacial SF 19" electronic enclosure

Solution at a Glance

IOT and Industry 4.0 transformations mean that critical IT and OT equipment is moving closer to where it's used. That's why Schneider Electric™ has expanded its EcoStruxure™ Micro Data Center R-series to include all new NEMA and IP ratings for harsh environments. It's everything you already love about EcoStruxure Micro Data Center – a complete, simple-to-deploy, simple-to-manage solution – fine-tuned for industrial use.



Up and running in weeks, not months.



Costs 42-48% less than typical data center build!



Securely manage from anywhere.

Secure physically to ensure cybersecurity

- NEMA and IP rating for harsh environments
- Essential access control
- Environmental monitoring and alerts
- Remote video surveillance



Enclosure description



- Structure: Top and bottom frame and vertical uprights.
- Plain front door
- Plain rear door.
- Locking system with handle and insert key **NSYIN405E1**
- Removable roof assembled
- External fixing of double-folded side panels to increase rigidity, captive fixing screws that reduce installation time.
- Side panels mounted
- Plinth H=100mm mounted
- Gland plate mounted
- 4 crossrails mounted (2 on each side) for 1200 (47.24) heights
- 6 crossrails mounted (3 on each side) for 2000 (78.74) heights
- 4 x 19" upright mounted
- Enclosure width 800 with support bracket **NSYCRKS...** and **NSYRCK19KIT** in order to mount 19" upright
- 5 earthcable **NSYEL2225D8** mounted
- Material: Steel
- Finish: Structured finish, epoxy polyester powder
- Color: RAL 7035 grey
- UL, CUL according to UL 508A and CSA C22.2 NO.14
- Nema 1 and 12 according to NEMA 250
- RoHS and REACH directive compliance.

For more details Please consult us

Characteristics	Height mm (in.)	Width mm (in.)	Depth mm (in.)	References
Spacial SF 12x8x6 Solution Edge Micro data center	1200 (47.24)	600 (23.62)	800 (31.50)	NSYSFRSEDC1268E
Spacial SF 20x6x8 Solution Edge Micro data center	2000 (78.74)	600 (23.62)	800 (31.50)	NSYSFRSEDC268E
Spacial SF 20x8x10 Solution Edge Micro data center	2000 (78.74)	800 (31.50)	1000 (39.37)	NSYSFRSEDC281E
Spacial SF 20x6x10 Solution Edge Micro data center	2000 (78.74)	600 (23.62)	1000 (39.37)	NSYSFRSEDC261E
Spacial SF 20x8x12 Solution Edge Micro data center	2000 (78.74)	800 (31.50)	1200 (47.24)	NSYSFRSEDC2812E

Technical changes reserved. Information provided without guarantee. Images are for illustrative purposes only.

Electromagnetic interference

Introduction

LV networks are highly polluted and subject to a large number of aggressions. Electrotechnical equipment and in particular electronic devices, which are increasingly numerous and process ever lower signals, must withstand a harsh electromagnetic environment. At the same time availability requirements, whether for production, management or commerce, are steadily increasing.

Definition

Electromagnetic interference is defined as any electromagnetic phenomenon capable of impairing the performance of a device, equipment or system, etc. An electromagnetic disturbance can be electromagnetic noise, an unwanted signal or a change in the propagation medium itself.

An electromagnetic disturbance, as its name suggests, consists of an electric field \vec{E} generated by a potential difference and a magnetic field \vec{H} difference caused by the flow of a current I along a conductor.

Unwanted electromagnetic interference is simply an unwanted electrical signal that is added to the useful signal.

This unwanted signal is propagated via conductors and by radiation.

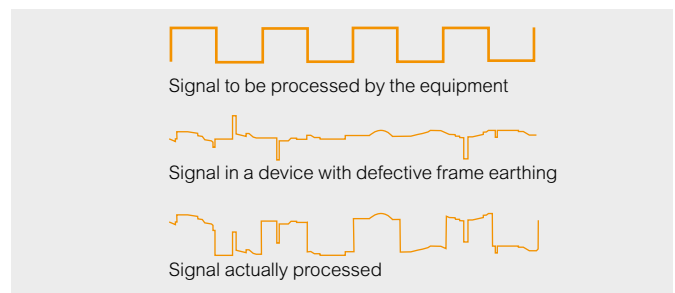
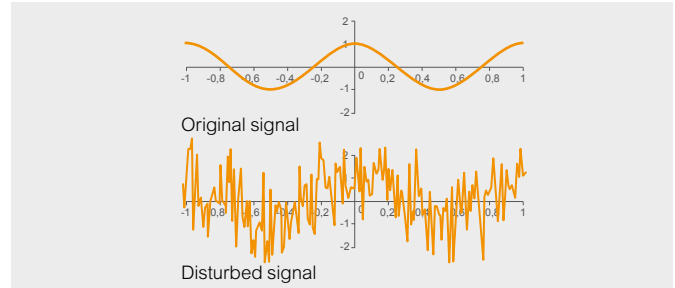

Examples of sources of electromagnetic interference

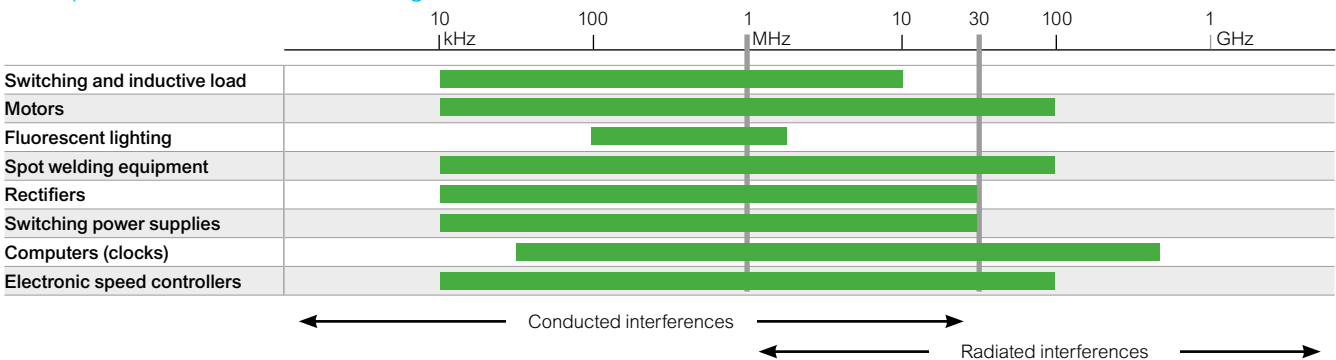

EMC standards

The standards define electromagnetic compatibility (EMC) as "the ability of a device, equipment or a system to function satisfactorily in its electromagnetic environment without introducing intolerable disturbances to that environment or to other equipment".

Classification

In an electrical switchboard, the signals coming from these sources of disturbance will coexist with more sensitive devices. These signals may be classified as follows (sources: standards IEC 61000-5-2 and IEC 60364-4-44):

Class	Examples
1 Sensitive	<ul style="list-style-type: none"> Low-power devices with analog output, transducers etc. Instrument circuits (probe, sensors...)
2 Not very sensitive	<ul style="list-style-type: none"> Control/command circuits with resistive load Digitalized low-level circuits (Bus...) Low-level circuits with on-off output unit (sensors...) Low-level direct power supply
3 Not very disturber	<ul style="list-style-type: none"> Control/command circuits with inductive load (relay, contactors, coils, inverters...) with adapted protection Alternating power supply Main power supply connected to power devices
4 Disturber	<ul style="list-style-type: none"> Welding machines Power circuits Drives, switched-mode power supplies ...

How to obtain EMC

Rules to be followed: General description

Electromagnetic interference generated by devices is classified in 2 categories according to its frequency:

- Low frequency (up to 30 MHz): Interference conducted by sensor cables;
- High frequency (above 1 MHz): Interference radiated by a device.

The rules to be followed concern the selection and installation of the electrical installation's components. Overall, they break down as follows:

Conducted interferences

- Importance of the choice of architecture for the power supplies and associated protective devices.
- Use of filters.

Radiated interferences

- Specification of installation rules: grounding, length and cross section of cables, cabling rules, choice of cable tray, connections, choice and installation of the enclosure.
- Use of filters.

Shielding connection

Shielding connections eliminate interference by conducting them to earth. The decision to connect one or both ends to earth means priority is given to protection against low or high frequencies:

- If one end is earthed, 50-Hz stray current cannot flow, HF protection is moderate;
- if both ends are earthed, 50-Hz current may occur but the barrier against higher frequencies is enhanced.

Isolation transformers

Isolation transformers are used to guard against high-frequency disturbances generated by the network power supply (primary circuit). An electrostatic shield is connected to earth by a short link. This link must be free of paint and any other insulated material. Physical separation of the cables of the primary circuit (network power supply) and those of the secondary circuit (power distribution) is also essential.

Earth connection of metal raceways

Increasing shielding efficiency of highly disturbing cables

The radiation from a shielded variable speed drive/motor connecting cable will be further reduced if it runs in a closed metal raceway or, even better, in a metal conduit. The raceway and tube need to be connected to earth at either end.

Enclosures

The interfering and sensitive components, cables etc. should be installed in separate enclosures or located at some distance from each other.

Note:

For further information, consult your local sales office or our educational leaflet entitled "Electromagnetic compatibility" - ref. **UE17MK08FR**.

Connect the shielding

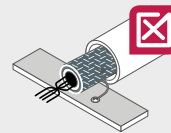

Example 1
Shielding connected to frame earth by a wire (pigtail) and no mechanical fastener.

Arrangement to be avoided.

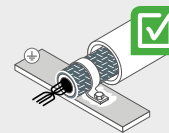

Example 2
Shielding connected to frame earth over its entire circumference, but no mechanical fastener.

Acceptable arrangement.

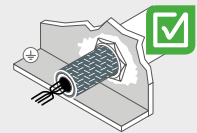

Example 3
Shielding connected to frame earth over its entire circumference, and a mechanical fastener.

Recommended arrangement.

Isolation transformers

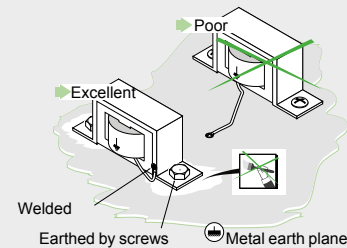

Earth connection of metal raceways

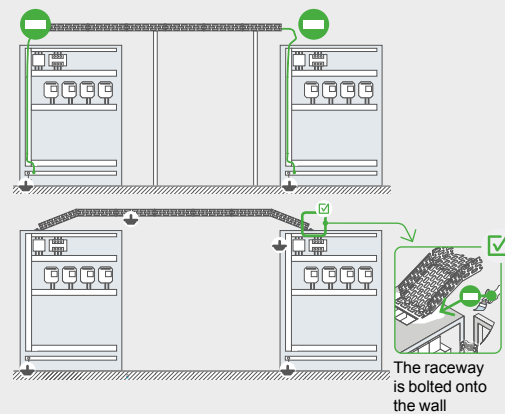

Enclosures

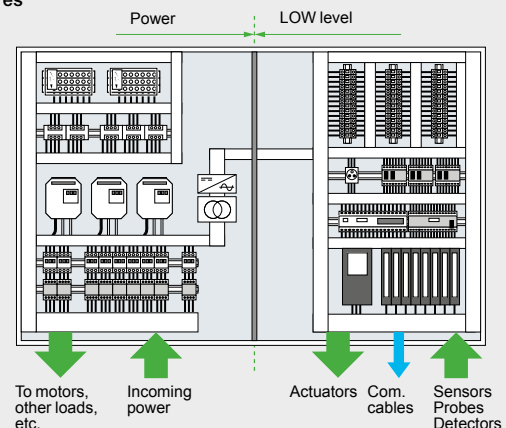

EMC offer of Schneider Electric



Spacial S3HF wall-mounted enclosure, IP55, IK10

From H 400 (15.75) x W 300 (11.81) x D 200 (7.87) to H 1200 (47.24) x W 800 (31.50) x D 300 (11.81) mm (in.)

- Metal monobloc enclosures constructed from special ALU-ZINC 150 sheet.
- Body constructed from single folded and welded sheet.
- The enclosure surface, comprising 55% aluminum, ensures good reflection of radiated electromagnetic interference.
- Ingress protection rating: IP55.
- Mechanical protection rating: IK10.
- Structured finish, exclusively epoxy polyester paint on the outside
- RAL 7035 grey.

Spacial SFHF suitable enclosure IP55 IK10

From H 1800 (70.87) x W 600 (23.62) x D 600 (23.62) to H 2200 (86.61) x W 800 (31.50) x D 800 (31.50) mm (in.)

- Metal, extendable enclosure constructed from a closed triangular profile, door and panel from special ALU-ZINC 150 sheet.
- The enclosure surface, comprising 55% aluminum, ensures good reflection of radiated electromagnetic interference.
- Ingress protection rating: IP55.
- Mechanical protection rating: IK10.
- Structured finish, exclusively epoxy polyester paint on the outside
- RAL 7035 grey.

Attenuation of electromagnetic interference

The next illustrations indicates the attenuation (dB) curves related to the frequency (MHz).

Attenuation of the Spacial S3HF enclosure

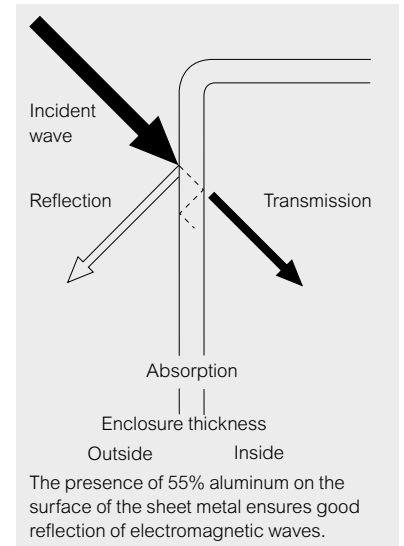
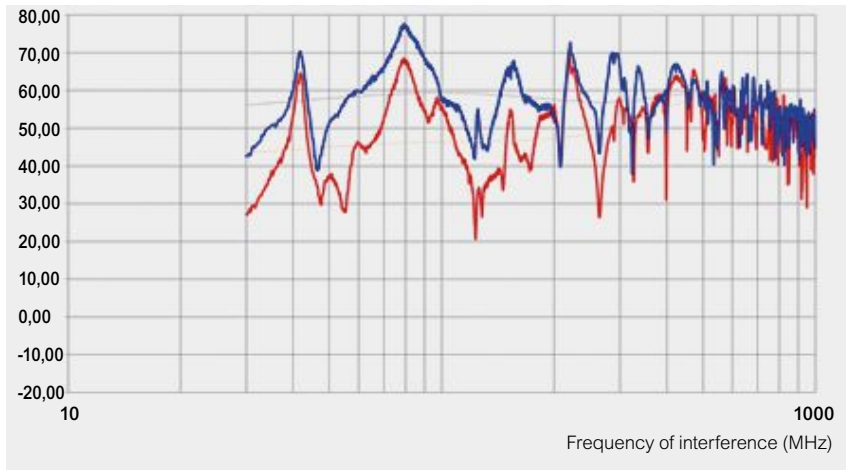

Attenuation of the Spacial SFHF suitable enclosure

Enclosure is tested with its sides panels and earth braids mounted on all claddings (test performed following IEC 61587-3).

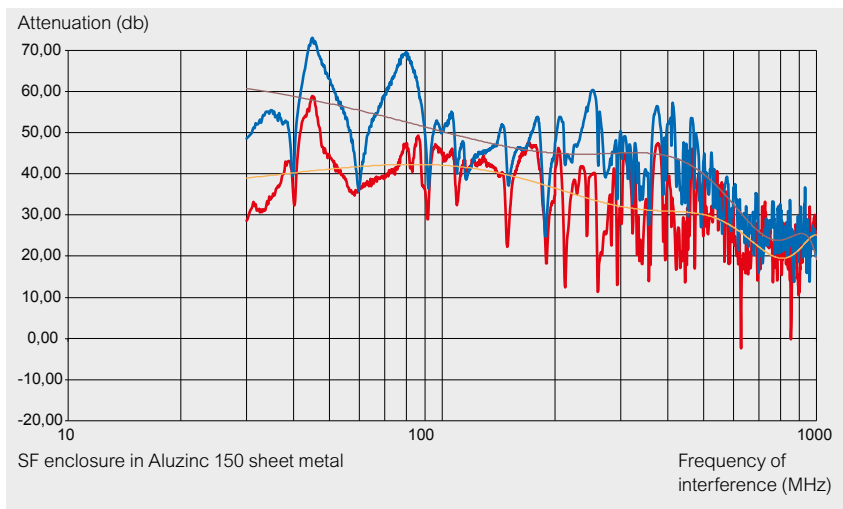

Attenuation curves

— Horizontal attenuation — Vertical attenuation

Trend curves (polynomial of order 6)

— Horizontal attenuation — Vertical attenuation

Spacial S3HF

- Single-piece metal enclosures made from special sheets of ALUZINC 150.
- The presence of 55% aluminum on the surface of the sheet metal ensures good reflection of electromagnetic waves.

Body

- Single-piece body, folded and welded,
- Entirely sealed body with no cable entry and no opening,
- Equipped with four shouldered backstuds allowing direct fixing of the mounting plate,
- Low resistivity for good earth continuity
- Direct fixing or using wall fixing lugs, ref. **NSYPFCR** (to be ordered separately).

Door

- The special body-door gasket (IP + EMC) provides, in addition to water and dust tightness, electric continuity between the door and the body of the enclosure,
- The metal lock with earth continuity helps improve the general shielding,
- An earthing braid added to the enclosure between the body and the door guarantees a good earth connection and, consequently, good electromagnetic compatibility,
- 3 (0.12 mm (in.)) double-bar lock as standard delivery (if a 405 key is needed it is possible to mount ref. **NSYCLL405CRN**).
- Other sizes: Consult us.
- Finish: Structured finish, epoxy polyester powder (inside not painted)
- Color: RAL 7035 grey
- Ingress protection rating: IP55 according to IEC 60529
- Mechanical protection rating: IK10 according to IEC 62262
- Certifications and declarations: UL, CE declaration
- Fixing: Fixing lugs, ref. **NSYPFCR** to be ordered separately (1 set of 4 lugs)

For more details see [page 385](#)

Supply:

Enclosure delivered with galvanized mounting plate.



NSYS3HF4320P

Characteristics	Fig.	Weight kg (lbs.)	Width mm (in.)	Height mm (in.)	Depth mm (in.)	References
Spacial S3HF	1	7.5 (16.53)	300 (11.81)	400 (15.75)	200 (7.87)	NSYS3HF4320P
Spacial S3HF	2	13.0 (28.66)	400 (15.75)	600 (23.62)	200 (7.87)	NSYS3HF6420P
Spacial S3HF	2	20.5 (45.19)	600 (23.62)	600 (23.62)	250 (9.84)	NSYS3HF6625P
Spacial S3HF	2	32.8 (72.31)	600 (23.62)	800 (31.50)	300 (11.81)	NSYS3HF8630P
Spacial S3HF	2	53.2 (117.29)	800 (31.50)	1000 (39.37)	300 (11.81)	NSYS3HF10830P

Support bracket for enclosure with anti-tilt kit and reinforcement

- The support bracket is used when the enclosure cannot be mounted to a wall or post.
- Maximum enclosure dimensions: 1000 (39.37) x 800 (31.50) x 300 (11.81) mm (in.).
- Floor attachment by standard M12 fasteners.
- Material: Steel
- Finish: Epoxy polyester paint
- Color: RAL 7035 grey
- Maximum load: 120 (264.55) kg (lbs.)



NSYCOENS1400

Characteristics	Height mm (in.)	References
Support bracket for enclosure with anti-tilt kit and reinforcement	1400 (55.12)	NSYCOENS1400
Support bracket for enclosure with anti-tilt kit and reinforcement	1800 (70.87)	NSYCOENS1800

Spacial SFHF

Structure

- Galvanized steel structure,
- Top and bottom frame, vertical upright.

Claddings

- Enclosure with screwed panels (on side and rear) and front plain door (with reinforcement frame) made from Aluzinc steel,
- Side panels to be ordered separately,
- Special gasket (IP + EMC) between body, door and panels.
- Finish: Epoxy polyester paint on the outside (inside not painted)
- Color: RAL 7035 grey
- Ingress protection rating: IP55
- Mechanical protection rating: IK10
- Certifications: RoHS compliant
- Dimensions manufacturing on demand

Note:

Only available on demand.
For more details see [page 385](#)

Supply:

- 1 single plain door with door-reinforcement frame (double-door on request, please consult us).
- Left or right opening to 120°.
- Delivered with standard locking system handle and 5 (0.20) mm (in.) double-bar insert.
- 1 rear panel screwed from the outside.
- 1 removable roof.
- 1 part cable gland plate with special gasket (IP + EMC).



Characteristics	Height mm (in.)	Width mm (in.)	Depth mm (in.)	References
Spacial SFHF	1800 (70.87)	600 (23.62)	600 (23.62)	
Spacial SFHF	1800 (70.87)	800 (31.50)	400 (15.75)	
Spacial SFHF	1800 (70.87)	800 (31.50)	600 (23.62)	
Spacial SFHF	2000 (78.74)	600 (23.62)	400 (15.75)	
Spacial SFHF	2000 (78.74)	600 (23.62)	600 (23.62)	
Spacial SFHF	2000 (78.74)	600 (23.62)	800 (31.50)	
Spacial SFHF	2000 (78.74)	600 (23.62)	1000 (39.37)	
Spacial SFHF	2000 (78.74)	800 (31.50)	400 (15.75)	
Spacial SFHF	2000 (78.74)	800 (31.50)	600 (23.62)	
Spacial SFHF	2000 (78.74)	800 (31.50)	800 (31.50)	
Spacial SFHF	2000 (78.74)	800 (31.50)	1000 (39.37)	
Spacial SFHF	2200 (86.61)	600 (23.62)	600 (23.62)	
Spacial SFHF	2200 (86.61)	800 (31.50)	600 (23.62)	
Spacial SFHF	2200 (86.61)	800 (31.50)	800 (31.50)	

Side panel

- Finish: Epoxy polyester paint on the outside (inside not painted)
- Color: RAL 7035 grey
- Dimensions manufacturing on demand

Note:

Only available on demand.

Characteristics	Height mm (in.)	Width mm (in.)	References
Side panel	1800 (70.87)	600 (23.62)	
Side panel	1800 (70.87)	400 (15.75)	
Side panel	2000 (78.74)	400 (15.75)	
Side panel	2000 (78.74)	600 (23.62)	
Side panel	2000 (78.74)	800 (31.50)	
Side panel	2000 (78.74)	1000 (39.37)	
Side panel	2200 (86.61)	600 (23.62)	
Side panel	2200 (86.61)	800 (31.50)	

All mounting accessories are compatible with the SF and SM standard range.

- Mounting plate (see page 245).
- Rails (see page 253).
- 19" frame (fixed and swing-out) (see page 368).



Earth braids

- They guarantee the earth connection for high frequencies, avoiding the disturbing electric currents that are produced.
- Material: Tinned copper.

Supply:

10 earth braids (nuts and washers not included)



NSYEB156D6

Characteristics	Section (mm ²)	Terminal Ø mm (in.)	Length mm (in.)	Width mm (in.)	References
Earth braids	6	6.5 (0.26)	150 (5.91)	12 (0.47)	NSYEB156D6
Earth braids	10	6.5 (0.26)	150 (5.91)	17 (0.67)	NSYEB1510D6
Earth braids	16	8.5 (0.34)	155 (6.10)	17 (0.67)	NSYEB1516D8
Earth braids	25	8.5 (0.34)	200 (7.87)	27 (1.06)	NSYEB2025D8
Earth braids	50	8.5 (0.34)	200 (7.87)	33 (1.30)	NSYEB2050D8

EMC coupling kit

- Used to join enclosures side-by-side or back-to-back. Special gasket for EMC solution.
- Attenuation level is decreased by 5 db when enclosures are joined (please consult us).
- Ingress protection rating: IP55.

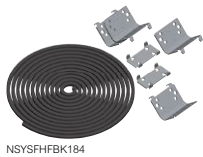

NSYSFHFBK184

Characteristics	Height mm (in.)	Depth mm (in.)	References
EMC coupling kit	1800 (70.87)	400 (15.75)	NSYSFHFBK184
EMC coupling kit	1800 (70.87)	600 (23.62)	NSYSFHFBK186
EMC coupling kit	2000 (78.74)	400 (15.75)	NSYSFHFBK204
EMC coupling kit	2000 (78.74)	600 (23.62)	NSYSFHFBK206
EMC coupling kit	2000 (78.74)	800 (31.50)	NSYSFHFBK208
EMC coupling kit	2000 (78.74)	1000 (39.37)	NSYSFHFBK2010
EMC coupling kit	2200 (86.61)	600 (23.62)	NSYSFHFBK226
EMC coupling kit	2200 (86.61)	800 (31.50)	NSYSFHFBK228

EMC cable gland with contact spring

- Thread type: Metric EN 60423, other types are available upon request
- Material: Nickel-plated brass, neoprene gasket
- Ingress protection rating: IP66
- Flame resistance: UL94 V-2
- Temperature range: -20°C (-4°F) to + 100°C (212°F)
- Cable type: Unshielded

Supply:

The cable glands are supplied with nuts.
Pack of 10 (M12 and M16), of 5 (M20 and M25),
of 4 (M32 and M40)



NSYCGHF12

Characteristics	Ø	Ø min/max	Drill Ø	TD	TL	Wrench width mm (in.)	References
New EMC cable gland with contact spring	M12	3/6.5	12 to 12.2	12	6	14 (0.55)	NSYCGHF12
New EMC cable gland with contact spring	M16	5/10	16 to 16.2	16	7	20 (0.79)	NSYCGHF16
New EMC cable gland with contact spring	M20	6/12	20 to 20.2	20	8	22 (0.87)	NSYCGHF20
New EMC cable gland with contact spring	M25	11/17	25 to 25.2	25	8	27 (1.06)	NSYCGHF25
New EMC cable gland with contact spring	M32	15/21	32 to 32.3	32	8	34 (1.34)	NSYCGHF32
New EMC cable gland with contact spring	M40	19/28	40 to 40.3	40	9	43 (1.69)	NSYCGHF40

Spacial S3HF

Fig. 1

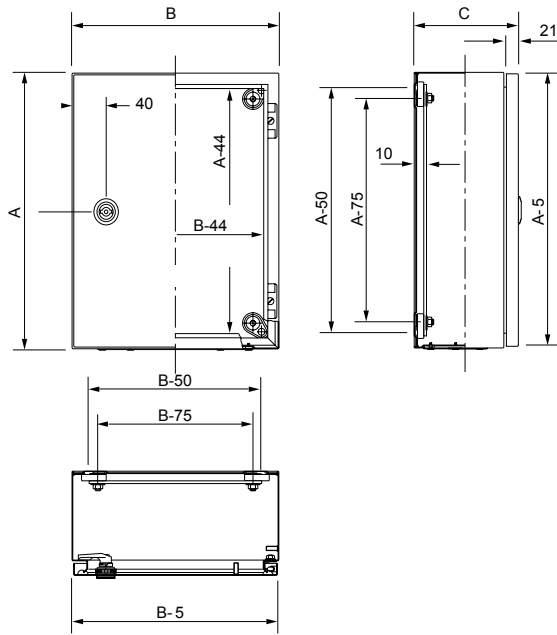
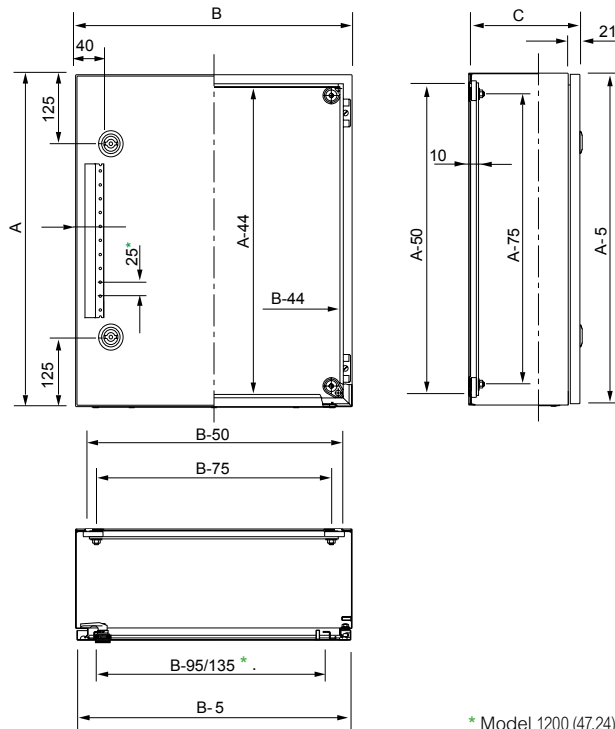

Fig. 2



A: Height
B: Width
C: Depth

* Model 1200 (47.24) x 800 (31.50) mm (in.)

Spacial SFHF

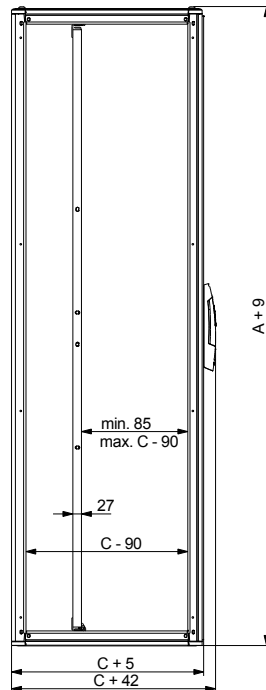
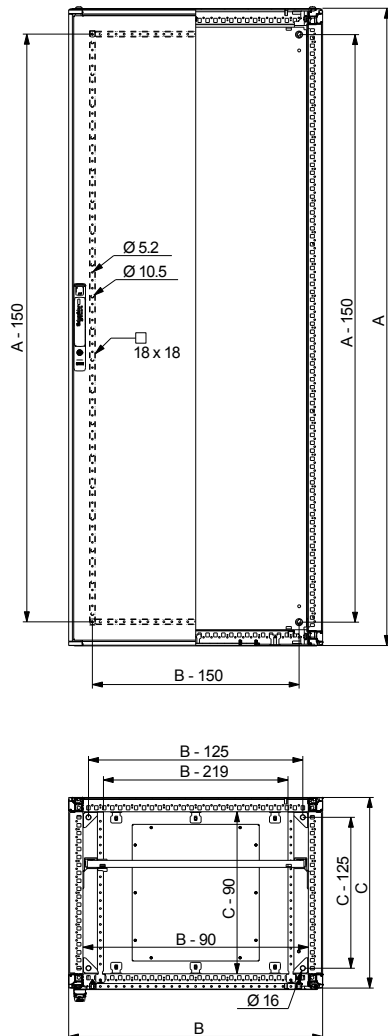

A: Height
B: Width
C: Depth

Industrial environments, equipment rooms

Spacial S3DEX steel enclosure

The Spacial S3DEX steel enclosure is certified by the LCIE with no. LCIE 02ATEX0037U (component certification).

- Ten sizes: From 300 (11.81) x 200 (7.87) x 150 (5.91) mm (in.) to 1000 (39.37) x 800 (31.50) x 300 (11.81) mm (in.).
- Degree of protection: IP66 according to IEC 60529.
- Ambient temperature range: -20°C (-4°F) ≤ Ta ≤ +40°C (104°F)
- Resistance to external mechanical impacts: IK10.
- Structured finish, epoxy polyester powder paint, RAL 7035 grey color.



Safety

- Blind nut for external earth connection.



- The 4 fixing holes are blocked by 4 crimped blind nuts.



- Earthing studs welded to the door and inside the body.

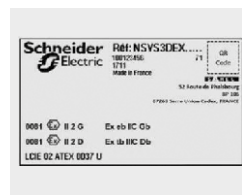

Label

- Example of specific ATEX marking (description: [Page 517](#)).



Robust

- The chassis is mounted on four 10 (0.39) mm (in.) shouldered backstuds.

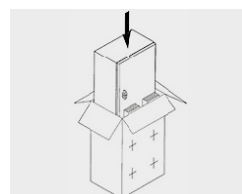

Easy handling

- Reusable, eco-friendly packaging.
- No sharp edges.



In accordance with the ATEX directive

- The enclosures bear the marking shown on [page 517](#).
- The enclosures offer a degree of protection of IP66 according to EN 60529, reaching the highest dust protection according to ATEX standards.
- The certification of our production sites and inspection procedures guarantees the observance and regularity of the quality level.

Protection of all applications in ATEX II2 or II3 areas

- Surface installations with occasional or accidental
- Thanks to ATEX-certified steel.

ATEX enclosures from Schneider Electric



Steel enclosures

- All the wall-mounted enclosures presented in this brochure comply with standards for protection against the potential risk of explosion in atmospheres containing gas (G) or dust (D).
- The Schneider Electric offer, designed to be used in group II, is classified as category 2.

Protection of equipment against explosion			ATEX	
Group *	Category	Level	Probability	Zone
I	M1	Very high	Permanent	0 / 20
I	M2	High	Occasional	1 / 21
II	1	Very high	Permanent	0 / 20
II	2	High	Occasional	1 / 21
II	3	Normal	Accidental	2 / 22

* I = equipment designed to be used in the mining and quarrying industries
 II = equipment designed to be used in surface industries

 Zone of application of Schneider Electric ATEX wall-mounted enclosures.

- Products of category 2 can be used as category 3.
- Our products are certified:**
- For gas environments: Increased safety "e" (Ex e) but not flameproof safety "d" (Ex d);
 - For dust environments: Protection by enclosure "t" or "tb".
 - The wall-mounted enclosures offer a degree of protection of IP66 according to IEC 60529, exceeding the recommendations of the ATEX directive.
 - Certification of our production sites and inspection procedures guarantees observance and consistency of the quality level.

Potentially explosive atmospheres (ATEX)

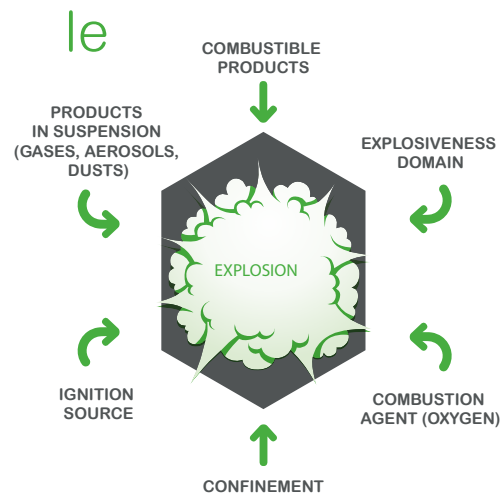

Explosion hexagon

Process leading to an explosion in an explosive atmosphere

For an explosion to occur, six conditions must be met simultaneously (see explosion hexagon opposite). The process is as follows:

- Mixing combustible substances (gases, dusts) with air whose oxygen acts as combustion agent;
- Dosing of combustible products and combustion agents in precise proportions; thereby obtaining a potentially explosive atmosphere;
- Confining the explosive atmosphere thus obtained in a place conducive to explosion;
- Exposing it to an ignition source having sufficient energy to cause an explosion.

ATEX regulations

Two EU directives and an international standard regulate potentially explosive atmospheres:

- The objective of the two EU directives (the so-called ATEX directives) is to enhance protection from explosions by making various technical and organizational measures compulsory;
- The 2014/34/EU directive (a revision of the 94/9/EC directive) came into application on 20 April 2016. It describes the requirements that must be met by protection devices and systems, and the conformity assessment procedures;
- The 99/92/EC directive, a labour relations supplement to the preceding one, presents the minimum requirements to be met to improve the protection of workers liable to be exposed to ATEX-related risks.



Definition



Product directive 2014/34/UE: defines the manufacturers' obligations.



Personal protection directive 99/92/CE: defines the users' obligations.

Degree of protection:

In hazardous areas, equipment is required to offer a minimum degree of protection of IP54, but it can be tested or certified for a higher degree of protection.

- An IEC international standard harmonized with the European standard EN:
- IEC 60079: electrical equipment for potentially explosive gaseous atmospheres.

Classification

Locations liable to be in the presence of an explosive atmosphere have been classified according to 2 criteria:

- The probability assessed on a scale comprising 3 levels;
- The nature of the combustible product.

The following 6 ATEX zones are obtained:

Probability of an explosive atmosphere	Gas / vapor or mist	Dust
Place in which an explosive atmosphere is present constantly , or for long periods or frequently	Zone 0	Zone 20
Place in which an explosive atmosphere is likely to occur occasionally in normal operation	Zone 1	Zone 21
Place in which an explosive atmosphere is not likely to occur in normal operation or, if it does occur, will persist for a short period only	Zone 2	Zone 22

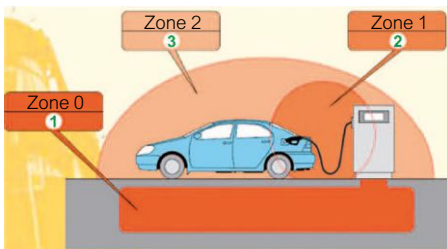

Equipment installed in an explosive-atmosphere zone must be protected against the risk of explosion. Three levels of protection have been defined, corresponding to the three probabilities of existence of an explosive atmosphere. They are broken down into 5 categories depending on the type of industry.

Protection of equipment against explosions			ATEX	
Group *	Category	Level	Probability	Zone
I	M1	Very high	Permanent	0 / 20
I	M2	High	Occasional	1 / 21
II	1	Very high	Permanent	0 / 20
II	2	High	Occasional	1 / 21
II	3	Normal	Accidental	2 / 22

* I = equipment designed to be used in the mining and quarrying industries
 II = equipment designed to be used in surface industries

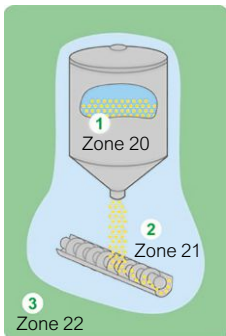

Protection of electrical equipment

The standards define various methods of protection for electrical equipment according to the application in explosive atmospheres containing gas or dust.

Electrical equipment		ATEX	Methods of protection	
CENELEC	IEC		Symbol	Title
EN 50015	IEC 60079-6	G, D	o	Immersion in oil
EN 50016	IEC 60079-2	G, D	p	Enclosures with internal overpressure
EN 50017	IEC 60079-5	G, D	q	Filling with powder product
EN 60079-1	IEC 60079-1	G, D	d	Explosion-proof enclosures
EN 60079-7	IEC 60079-7	G, D	e	Increased safety "e"
EN 50020	IEC 60079-11	G, D	i	Intrinsic safety
EN 60079-15	IEC 60079-15	G, D	n	Product design
EN 60079-31	IEC 60079-31	G, D	tD	Protection by enclosure "t"

G = gas / vapor or mist
D = dust

ATEX certification of electrical switchboards

- Since 1 July 2003, the European Union has made it compulsory to use certified equipment (electrical or non-electrical) when it is to be installed in areas where the atmosphere is potentially explosive.
- The certification must be established by an approved organization in accordance with the 2014/34/EU directive.
- The organization certifies that the product complies with the health and safety requirements defined in the European directive and the international standards.
- The certificate indicates, via the marking, the product's category and accordingly the zone and the atmosphere in which it may be used.
- Enclosures are certified as components. They will be assembled with other ATEX components (electrical, pneumatic, hydraulic, etc.), to form a final solution which must itself be ATEX-certified and covered by a declaration of conformity.

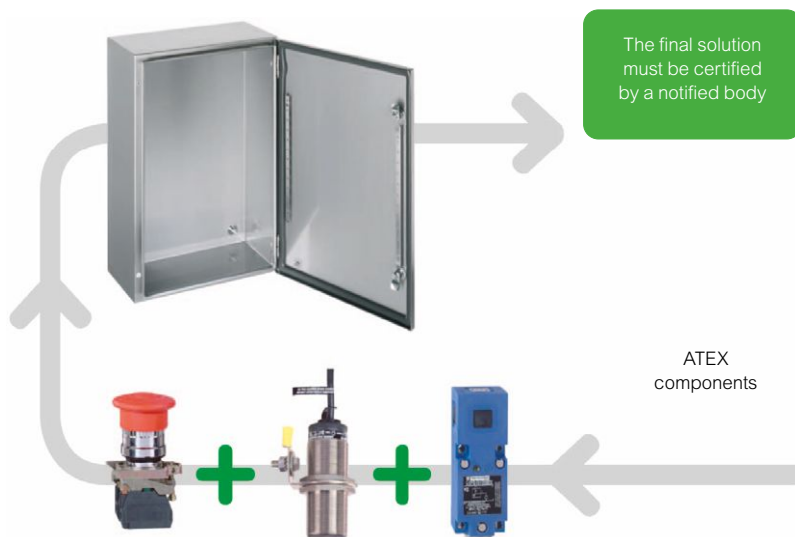

Spacial S3DEX

Protection for users

- Earthing: The Spacial S3DEX steel enclosures are provided with M6 x 16 earth studs welded to the casing and door for equipotential connection. Earth strap to be ordered separately.
- Closing: Enclosures higher than 600 (23.62) mm (in.) are provided with three locking points with connecting rods, with a single control point preventing the enclosures from being left half-open.

Casing

- Monobloc casing (cross-structure). Gutter-shaped front profile.
- 4 bottom shoulder studs M8 x 25 (0.98) mm (in.) for mounting the chassis and notched bars to provide a space of 10 (0.39) mm (in.) at the rear.

Door

- Standard fastening by 3 (0.12) mm (in.) double-bar lock
- Polyurethane door seal
- Double-thickness 20 (0.79) mm (in.) return conferring excellent rigidity;
- 2 concealed hinges (3 above H = 800 (31.50) mm (in.)) to facilitate dismantling and reversibility of the door. Opening angle: 120°
- Maximum load: 50 (110.23) kg (lbs.)/m².
- Perforated sections on the door, with holes of diameter 4.2 (0.16) mm (in.) every 25 (0.98) mm (in.) for mounting accessories:
- 2 vertical sections from H = 400 (15.75) mm (in.);
- 2 vertical sections and 2 horizontal sections from L = 800 (31.50) mm (in.).

Specific ATEX features

- 4 fastening holes closed by 4 crimped blind nuts.
- One crimped M8 blind nut for an external frame earth link (strap not provided)
- Ambient temperature: -20°C (-4°F) ≤ Ta ≤ +40°C (104°F)
- Marking: See [page 517](#).
- Material: Steel
- Finish: Structured finish, epoxi-polyester powder painting
- Color: RAL 7035 grey
- Ingress protection rating: IP66 (enclosures with single-door) according to IEC 60529
- Mechanical protection rating: IK10 (enclosures with plain door) according to IEC 62262
- Fixing: Wall fixing lugs:
 Passivated zinc-coated steel: Reference **NSYAEFPFSC**
 304L stainless-steel: Reference **NSYAEFPFXSC**



NSYS3DEX3215

Characteristics	Height mm (in.)	Width mm (in.)	Depth mm (in.)	References
Spacial S3DEX	300 (11.81)	200 (7.87)	150 (5.91)	NSYS3DEX3215
Spacial S3DEX	300 (11.81)	300 (11.81)	200 (7.87)	NSYS3DEX3320
Spacial S3DEX	400 (15.75)	300 (11.81)	200 (7.87)	NSYS3DEX4320
Spacial S3DEX	400 (15.75)	400 (15.75)	200 (7.87)	NSYS3DEX4420
Spacial S3DEX	500 (19.68)	400 (15.75)	200 (7.87)	NSYS3DEX5420
Spacial S3DEX	600 (23.62)	400 (15.75)	250 (9.84)	NSYS3DEX6425
Spacial S3DEX	600 (23.62)	600 (23.62)	250 (9.84)	NSYS3DEX6625
Spacial S3DEX	700 (27.56)	500 (19.68)	250 (9.84)	NSYS3DEX7525
Spacial S3DEX	800 (31.50)	600 (23.62)	300 (11.81)	NSYS3DEX8630
Spacial S3DEX	1000 (39.37)	800 (31.50)	300 (11.81)	NSYS3DEX10830



The accessories of the Spacial standard wall-mounted enclosures can be installed in the Spacial S3DEX wall-mounted enclosures. However, plastic accessories should not be used due to the risk of a static charge.

Mounting plate Plain



NSYMM32

Characteristics	Height mm (in.)	Width mm (in.)	References
Mounting plate Plain	300 (11.81)	200 (7.87)	NSYMM32
Mounting plate Plain	300 (11.81)	300 (11.81)	NSYMM33
Mounting plate Plain	308 (12.13)	255 (10.04)	NSYMM3025
Mounting plate Plain	400 (15.75) / 430 (16.93)	300 (11.81) / 330 (12.99)	NSYMM43
Mounting plate Plain	400 (15.75)	400 (15.75)	NSYMM44
Mounting plate Plain	500 (19.68) / 530 (20.87)	400 (15.75) / 430 (16.93)	NSYMM54
Mounting plate Plain	600 (23.62) / 647 (25.47)	400 (15.75) / 436 (17.16)	NSYMM64
Mounting plate Plain	600 (23.62)	600 (23.62)	NSYMM66
Mounting plate Plain	700 (27.56) / 747 (29.41)	500 (19.68) / 536 (21.10)	NSYMM75
Mounting plate Plain	800 (31.50) / 847 (33.35)	600 (23.62) / 636 (25.04)	NSYMM86
Mounting plate Plain	1000 (39.37) / 1056 (41.58)	800 (31.50) / 852 (33.54)	NSYMM108

Mounting plate Silkscreened



NSYMS43

Characteristics	Height mm (in.)	Width mm (in.)	References
Mounting plate Silkscreened	400 (15.75) / 430 (16.93)	300 (11.81) / 330 (12.99)	NSYMS43
Mounting plate Silkscreened	400 (15.75)	400 (15.75)	NSYMS44
Mounting plate Silkscreened	500 (19.68) / 530 (20.87)	400 (15.75) / 430 (16.93)	NSYMS54
Mounting plate Silkscreened	600 (23.62) / 647 (25.47)	400 (15.75) / 436 (17.16)	NSYMS64
Mounting plate Silkscreened	600 (23.62)	600 (23.62)	NSYMS66
Mounting plate Silkscreened	700 (27.56) / 747 (29.41)	500 (19.68) / 536 (21.10)	NSYMS75
Mounting plate Silkscreened	800 (31.50) / 847 (33.35)	600 (23.62) / 636 (25.04)	NSYMS86

Mounting plate Microperforated

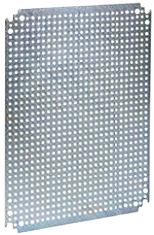

NSYMF33

Characteristics	Height mm (in.)	Width mm (in.)	References
Mounting plate Microperforated	300 (11.81)	300 (11.81)	NSYMF33
Mounting plate Microperforated	400 (15.75) / 430 (16.93)	300 (11.81) / 330 (12.99)	NSYMF43
Mounting plate Microperforated	400 (15.75)	400 (15.75)	NSYMF44
Mounting plate Microperforated	500 (19.68) / 530 (20.87)	400 (15.75) / 430 (16.93)	NSYMF54
Mounting plate Microperforated	600 (23.62) / 647 (25.47)	400 (15.75) / 436 (17.16)	NSYMF64
Mounting plate Microperforated	600 (23.62)	600 (23.62)	NSYMF66
Mounting plate Microperforated	700 (27.56) / 747 (29.41)	500 (19.68) / 536 (21.10)	NSYMF75
Mounting plate Microperforated	800 (31.50) / 847 (33.35)	600 (23.62) / 636 (25.04)	NSYMF86
Mounting plate Microperforated	1000 (39.37) / 1056 (41.58)	800 (31.50) / 852 (33.54)	NSYMF108

Mounting plate Telequick



NSYMR32

Characteristics	Height mm (in.)	Width mm (in.)	References
Mounting plate Telequick	300 (11.81)	200 (7.87)	NSYMR32
Mounting plate Telequick	300 (11.81)	300 (11.81)	NSYMR33
Mounting plate Telequick	308 (12.13)	255 (10.04)	NSYMR3025
Mounting plate Telequick	400 (15.75) / 430 (16.93)	300 (11.81) / 330 (12.99)	NSYMR43
Mounting plate Telequick	500 (19.68) / 530 (20.87)	400 (15.75) / 430 (16.93)	NSYMR54
Mounting plate Telequick	600 (23.62) / 647 (25.47)	400 (15.75) / 436 (17.16)	NSYMR64
Mounting plate Telequick	600 (23.62)	600 (23.62)	NSYMR66
Mounting plate Telequick	700 (27.56) / 747 (29.41)	500 (19.68) / 536 (21.10)	NSYMR75
Mounting plate Telequick	800 (31.50) / 847 (33.35)	600 (23.62) / 636 (25.04)	NSYMR86
Mounting plate Telequick	1000 (39.37) / 1056 (41.58)	800 (31.50) / 852 (33.54)	NSYMR108

Mixed symmetrical chassis



NSYMD33

Characteristics	Height mm (in.)	Width mm (in.)	References
Mixed symmetrical chassis	300 (11.81)	300 (11.81)	NSYMD33
Mixed symmetrical chassis	400 (15.75)	300 (11.81)	NSYMD43
Mixed symmetrical chassis	500 (19.68)	400 (15.75)	NSYMD54
Mixed symmetrical chassis	600 (23.62)	400 (15.75)	NSYMD64
Mixed symmetrical chassis	600 (23.62)	600 (23.62)	NSYMD66
Mixed symmetrical chassis	700 (27.56)	500 (19.68)	NSYMD75
Mixed symmetrical chassis	800 (31.50)	600 (23.62)	NSYMD86
Mixed symmetrical chassis	1000 (39.37)	800 (31.50)	NSYMD108

Step slides



NSYSDCR200

Characteristics	Depth mm (in.)	References
Step slides	200 (7.87)	NSYSDCR200
Step slides	200 (7.87)	NSYDPLM200
Step slides	250 (9.84)	NSYSDCR250
Step slides	250 (9.84)	NSYDPLM250
Step slides	300 (11.81)	NSYSDCR300
Step slides	300 (11.81)	NSYDPLM300
Step slides	350 (13.78)	NSYDPLM350

Single-door enclosure

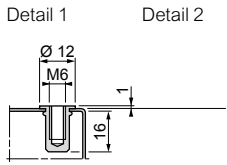
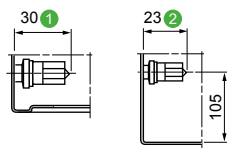

Detail 4
4 crimped blind nuts for direct fixing of the fixing lugs

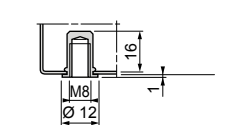

Detail 5
1 crimped blind nut for the external earth

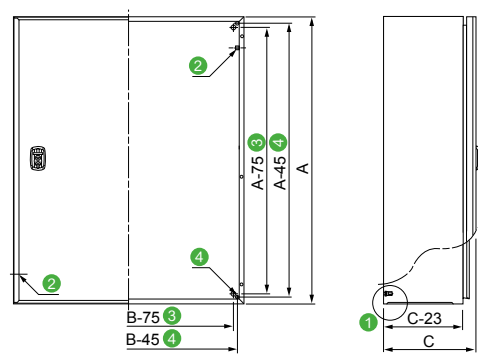

- 1 4 M8 x 25 (0.98) mm (in.) backstuds.
- 2 2 M6 x 17.5 (0.69) mm (in.) earthing studs.
- 3 Stud center-to-center distance.
- 4 Crimped blind nut center-to-center distance.
- 5 Blind nut for external earth.

A: Height
B: Width
C: Depth

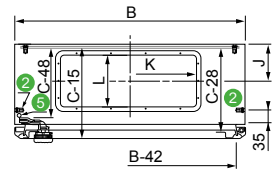

Perforated rails on the door

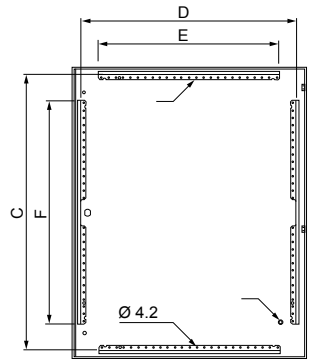

Enclosure (8)		Perforated rails on the door mm (in.)			
Height (A) mm (in.)	Width (B) mm (in.)	Vertical F	Vertical D	Horizontal E	Horizontal C
400 (15.75)	300 (11.81)	320 (12.60)	237 (9.33)	-	-
400 (15.75)	400 (15.75)	320 (12.60)	337 (13.27)	-	-
600 (23.62)	400 (15.75)	370 (14.57)	337 (13.27)	-	-
600 (23.62)	600 (23.62)	370 (14.57)	537 (21.14)	-	-
700 (27.56)	500 (19.68)	470 (18.50)	437 (17.20)	-	-
800 (31.50)	600 (23.62)	570 (22.44)	537 (21.14)	-	-
1000 (39.37)	800 (31.50)	770 (30.32)	737 (29.02)	620 (24.41)	949 (37.36)

- 6 Perforations with a pitch of 25 (0.98) mm (in.).
- 7 1 M6 x 17.5 (0.69) mm (in.) earthing stud.
- 8 The doors of enclosures with dimensions less than 800 (31.50) x 600 (23.62) mm (in.) do not have horizontal cable guides.

Human-Machine Interface Solutions

Indoor non-clean industrial environments

Steel



Demanding industrial environments

Stainless-steel



11

Technical changes reserved. Information provided without guarantee. Images are for illustrative purposes only.

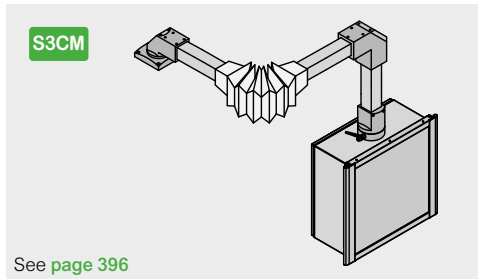

Spacial S3CM control enclosure with suspension system

The Spacial S3CM offer for human-machine interface combines robustness with aesthetics and ergonomics. Consist of:

- Control enclosure,
- A keyboard box,
- A suspension system of arms and joints, for a fixed or rotating solution and support accessories.



Spacial SD control desks

The range of Spacial SD control desks provides all functions required of a workstation intended for industrial and infrastructure applications. Spacial SD products offer two distinct solutions:

- The SD Compact control desk,
- The SD Control desk with console.

The range has protection ratings of IP55 and IK10 guaranteeing the safety and the protection of the installed devices.



Spacial SF suitable PC rack

The Spacial SF PC rack is designed to protect and control computer equipment in industrial environments. Access to various functions and working heights, guaranteeing optimal comfort. The roof and panels, fixed from the inside, prevent access by unauthorized personnel.



Spacial SDX Control desks

The Spacial SDX range of control desks offers all the functions required to set up a control station that meets the industrial or infrastructural needs of applications in harsh environments or in the food and beverage sector. These control panels are easy to implement, compatible with data communication components, and they ensure the safety and protection of control devices. They are available in many dimensions and meet the most stringent user requirements.



Spacial SMX monobloc PC rack

The stainless-steel monobloc PC racks have been especially designed to protect computer equipment installed in corrosive or specially environments that require washing or exposure to sprays of liquid. Access to the various functions and working heights ensure optimal comfort.

The Spacial S3CM offer for human-machine dialogue consists of: control enclosures, a box keyboard, a system of fixed or swiveling arms and joints, accessories. The global dialogue system combines robustness with aesthetics and ergonomics.

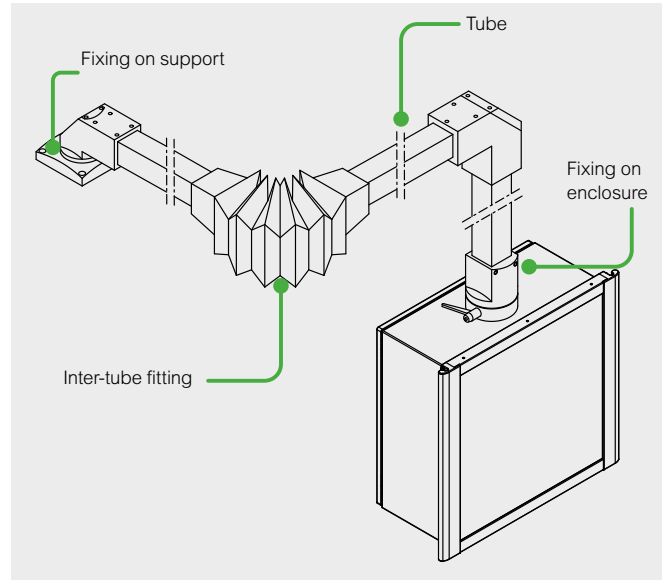

Human-Machine Interface Solutions



Robust

2 tube sizes in extruded steel, 50 (1.97) and 80 (3.15) mm (in.) square, thickness 40 (1.58)/10^e mm (in.). Top wall reinforced by a plate with a thickness of 30 (1.18)/10^e mm (in.).



Ease of use

Easy access to the equipment by a rear door, opening to 120°. Direct installation of accessories on the enclosure frame rail: - vertical document support, - keyboard support, - laptop computer support. A box keyboard is installed directly on the enclosure.



Aesthetics

Extruded aluminum rail frame. Frame: RAL 7040 Window grey Enclosure: RAL 7035 Light grey



Flexibility

Flexibility



Ergonomics

Frame designed to facilitate the handling and usage of the enclosure by the operator.

For details consult our web site www.se.com

Every model is suitable for tubes with a cross-section of:

- 50 (1.97) mm (in.) for medium loads,
- 80 (3.15) mm (in.) for heavy loads

(see selection table on [page 398](#)).

Steps to choose the suspension system (medium or heavy loads)

- 1 - Define the total load of the system*: a + b + enclosure + installed equipment (Y-axis).
- 2 - Define the length of arm L (X-axis).
- 3 - Define the configuration:

Suspension system without intermediate joint.

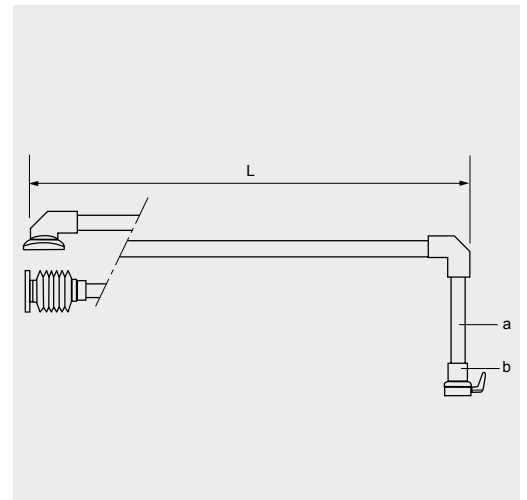
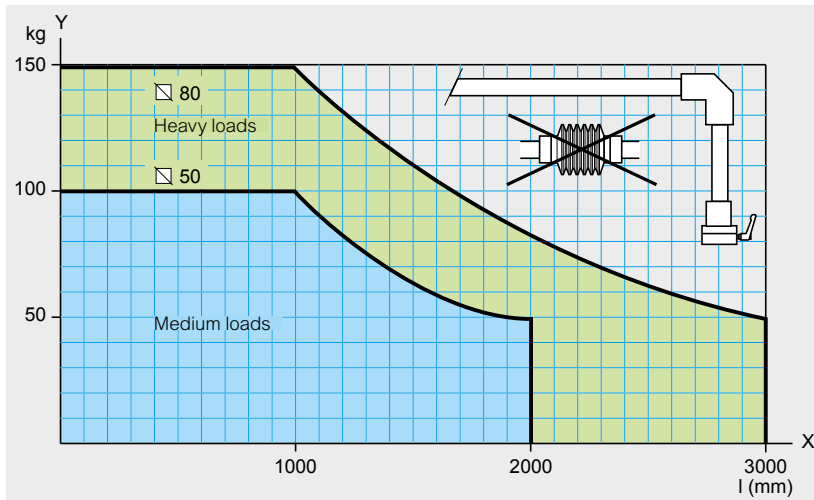

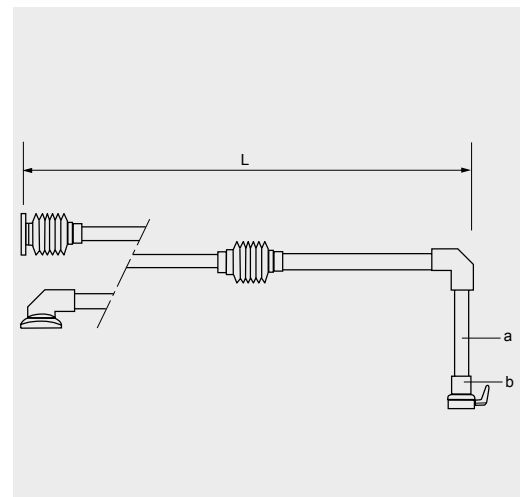
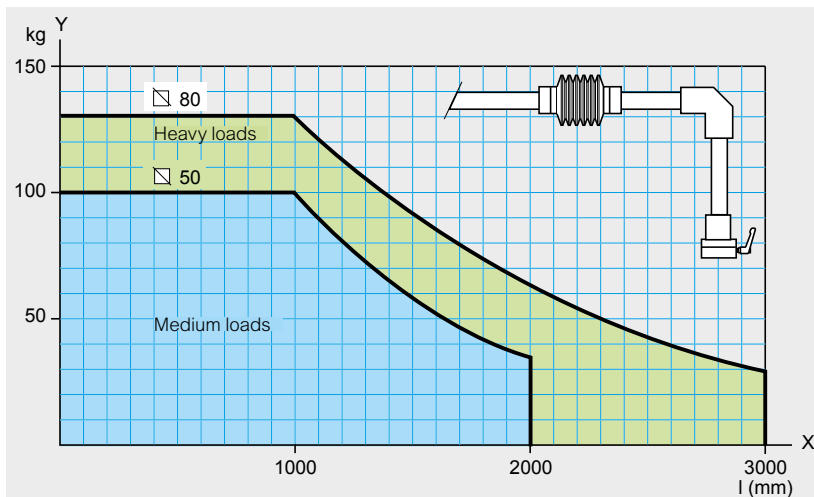

Suspension system with intermediate joint.

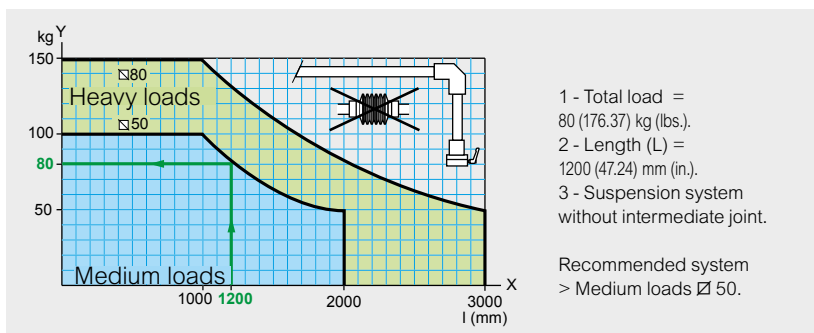

* The load (a + b + enclosure + installed equipment) must be less than the maximum load.

Example



Enclosure dimensions mm (in.)				Tube section U 50 (1.97) mm (in.)	Tube section U 80 (3.15) mm (in.)
	H mm (in.)	W mm (in.)	D mm (in.)	References	References
	300 (11.81)	300 (11.81)	200 (7.87)	NSYS3CM303020	-
	300 (11.81)	400 (15.75)	200 (7.87)	NSYS3CM304020	-
	400 (15.75)	400 (15.75)	200 (7.87)	NSYS3CM404020	-
	400 (15.75)	600 (23.62)	250 (9.84)	NSYS3CM406025*	-
	500 (19.68)	500 (19.68)	250 (9.84)	NSYS3CM505025	-
	600 (23.62)	600 (23.62)	200 (7.87)	NSYS3CM606020*	-
	600 (23.62)	800 (31.50)	300 (11.81)	-	NSYS3CM608030
	800 (31.50)	600 (23.62)	300 (11.81)	-	NSYS3CM806030*

Tube	Length (m)	Tube section U 50 (1.97) mm (in.)	Tube section U 80 (3.15) mm (in.)
		References	References
	0.5 (19.68)	NSYCMT5005	NSYCMT8005
	1 (39.37)	NSYCMT5010	NSYCMT8010
	1.5 (59.06)	NSYCMT5015	NSYCMT8015
	2 (78.74)	NSYCMT5020	NSYCMT8020

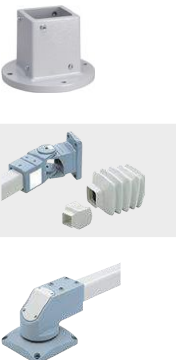
Fixing on support (steel material)		Tube section U 50 (1.97) mm (in.)	Tube section U 80 (3.15) mm (in.)
		References	References
	1 Fixed base	NSYCMUMR50	NSYCMUMR80
	2 Wall fixing with joint	NSYCMUMA50	NSYCMUMA80
	3 Rotating straight fitting	NSYCMUMC50	NSYCMUMC80

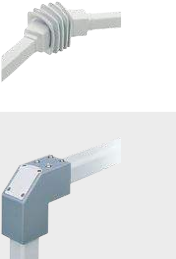
Inter-tube fitting (aluminum material)		Tube section U 50 (1.97) mm (in.)	Tube section U 80 (3.15) mm (in.)
		References	References
	4 Horizontal inter-tube joint	NSYCMUIA50	NSYCMUIA80
	5 Fixed bracket	NSYCMUTC50	NSYCMUTC80

Fixing on enclosure (aluminum material)		Tube section U 50 (1.97) mm (in.)	Tube section U 80 (3.15) mm (in.)
		References	References
	6 Rotating fixing on enclosure	NSYCMUCR50	NSYCMUCR80
	7 Rotating fixing in bracket on enclosure	NSYCMUCC50	NSYCMUCC80
	8 Tilting fixing on enclosure	NSYCMUCP50	NSYCMUCP80⁽¹⁾

* Enclosure equipped with a cable gland plate.

(1) Installation on an enclosure D 300 (11.81) mm (in.) requires plate ref. NSYCMUCPAD87 (see page 402).

Technical changes reserved. Information provided without guarantee. Images are for illustrative purposes only.

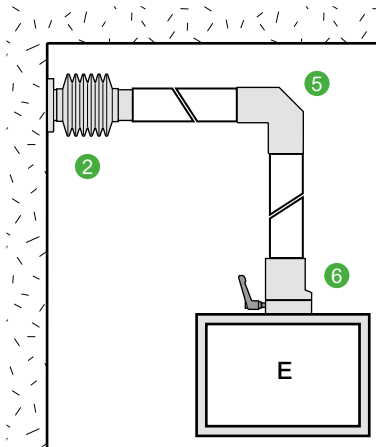

- Fixing on support
2 See page 401
- Inter-tube fitting
5 See page 402
- Fixing on enclosure
6 See page 402

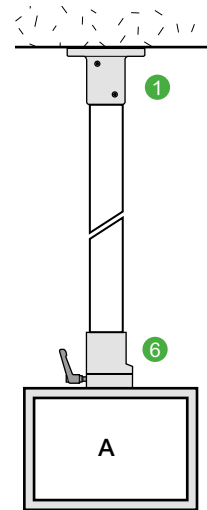

- Fixing on support
1 See page 401
- Inter-tube fitting
- Fixing on enclosure
6 See page 402

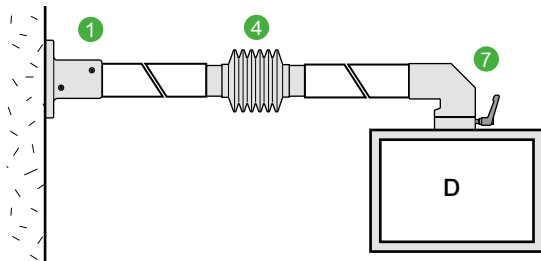

- Fixing on support
1 See page 401
- Inter-tube fitting
4 See page 401
- Fixing on enclosure
7 See page 402

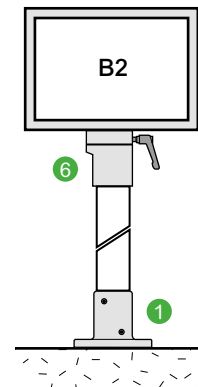

- Fixing on support
1 See page 401
- Inter-tube fitting
- Fixing on enclosure
6 See page 402

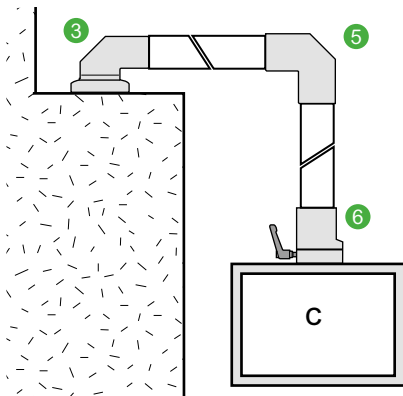

- Fixing on support
3 See page 401
- Inter-tube fitting
5 See page 402
- Fixing on enclosure
6 See page 402

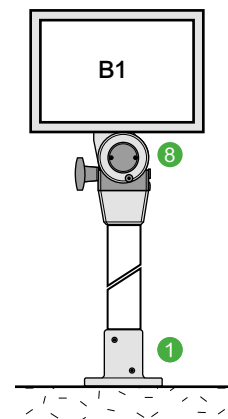

- Fixing on support
1 See page 401
- Inter-tube fitting
- Fixing on enclosure
8 See page 402

Spacial S3CM

The control enclosures consist of:

A steel body equipped with:

- Reinforcement plate: The top wall is reinforced by a plate (3 (0.12) mm (in.)) and pierced with a hole Ø 54 (2.13) or 87 (3.42) mm (in.) (according to the reference) to allow hanging installation of the enclosure,
- 4 welded studs on the 2 inner vertical walls, for fixing the rails,
- 2 rails (with drill holes) for installing equipment,
- A rear door, opening to 120° and closing with double-bar lock.

⁽¹⁾ Enclosure equipped with a cable gland plate

An aluminum front face (2.5 (0.10) mm (in.) thick):

- This surface is protected on both sides by a plastic film, allowing the installation of the dialogue elements,
- A trim frame made from 4 extruded-aluminum rails.
- Structured finish, epoxy polyester powder, RAL 7040 grey color (other colors on demand).
- The design of these rails takes into account the accessory mounting functions (lamp, document support, keyboard support, laptop support, etc.), the ergonomics for handling the enclosure and its overall aesthetics.
- Finish: Structured finish, epoxy polyester powder
- Color: RAL 7035 grey
- Ingress protection rating: IP54 according to IEC 60529
- Mechanical protection rating: IK10 according to IEC 62262

For more details see [page 424](#)



Characteristics	Enclosure load kg (lbs.)	Tube section mm (in.)	Height mm (in.)	Width mm (in.)	Depth mm (in.)	References
HMI encl. Spacial S3CM	8.6 (18.96)	50 (1.97)	300 (11.81)	300 (11.81)	200 (7.87)	NSYS3CM303020
HMI encl. Spacial S3CM	9.5 (20.94)	50 (1.97)	300 (11.81)	400 (15.75)	200 (7.87)	NSYS3CM304020
HMI encl. Spacial S3CM	11.4 (25.13)	50 (1.97)	400 (15.75)	400 (15.75)	200 (7.87)	NSYS3CM404020
HMI encl. Spacial S3CM ⁽¹⁾	17.9 (39.46)	50 (1.97)	400 (15.75)	600 (23.62)	250 (9.84)	NSYS3CM406025
HMI encl. Spacial S3CM	20.2 (44.53)	50 (1.97)	500 (19.68)	500 (19.68)	250 (9.84)	NSYS3CM505025
HMI encl. Spacial S3CM ⁽¹⁾	26.5 (58.42)	50 (1.97)	600 (23.62)	600 (23.62)	200 (7.87)	NSYS3CM606020
HMI encl. Spacial S3CM	34.9 (76.94)	80 (3.15)	600 (23.62)	800 (31.50)	300 (11.81)	NSYS3CM608030
HMI encl. Spacial S3CM ⁽¹⁾	33.6 (74.08)	80 (3.15)	800 (31.50)	600 (23.62)	300 (11.81)	NSYS3CM806030

Human-Machine Interface - specific accessories

Box keyboard for control enclosure

- The box is installed on the control enclosures with a width of 600 (23.62) mm (in.). It then has an angle of 120° with its front face. All the accessories required for installation are delivered with 2 brackets and 1 trim rail, 1 hose for cable entry.

The box consists of:

- A steel body, structured finish, epoxy polyester powder, RAL 7035 grey color, with a screwed cover, an aluminum front face (2.5 (0.10) mm (in.) thick) for installing a keyboard,

- A trim frame made from 2 extruded-aluminum rails guaranteeing ergonomic handling of the box and the aesthetics of the unit. The frame and the front face are delivered assembled. Structured finish, epoxy polyester powder painting, RAL 7040 grey color.
- Ingress protection rating: IP54
- Mechanical protection rating: IK10
- Weight: 8 (17.64) kg (lbs.)

For more details see [page 425](#)



Characteristics	Height mm (in.)	Width mm (in.)	References
Box-keyboard for control enclosure	250 (9.84)	600 (23.62)	NSYCMT2560110

Support

- Installation on the left or right rail of the frame of the control enclosure.
- Material: Sheet steel
- Finish: Structured finish, epoxy polyester powder
- Color: RAL 7035 grey
- Thickness: 15 (0.59)/10^e mm (in.)

For more details see [page 425](#)



Characteristics	References
Support for Keyboard	NSYCMBPT

Tube

The tubes are available in:

- 2 sizes: Square of 50 (1.97) and 80 (3.15) mm (in.),
- 4 lengths: 0.5 (19.68) m (in.), 1 (39.37) m (in.), 1.5 (59.06) m (in.) and 2 (78.74) m (in.)
- Material: Extruded steel
- Finish: structured finish, powder
- Color: RAL 7035 grey
- Thickness: 40 (1.58)/10° mm (in.)



NSYCMT5005

Characteristics	Square mm (in.)	Length (m)	Weight kg (lbs.)	References
Tube	50 (1.97)	0.5 (19.68)	6.5 (14.33)	NSYCMT5005
Tube	50 (1.97)	1 (39.37)	6.5 (14.33)	NSYCMT5010
Tube	50 (1.97)	1.5 (59.06)	6.5 (14.33)	NSYCMT5015
Tube	50 (1.97)	2 (78.74)	6.5 (14.33)	NSYCMT5020
Tube	80 (3.15)	0.5 (19.68)	10.5 (23.15)	NSYCMT8005
Tube	80 (3.15)	1 (39.37)	10.5 (23.15)	NSYCMT8010
Tube	80 (3.15)	1.5 (59.06)	10.5 (23.15)	NSYCMT8015
Tube	80 (3.15)	2 (78.74)	10.5 (23.15)	NSYCMT8020

Fixed base



NSYCMUMR50

- Support foot for direct horizontal or vertical connection.
- Material: Molded steel
- Color: RAL 7040 grey

For more details see [page 426](#)

Characteristics	Square mm (in.)	Weight kg (lbs.)	References
Fixed base	50 (1.97)	3.25 (7.17)	NSYCMUMR50
Fixed base	80 (3.15)	7 (15.43)	NSYCMUMR80

Wall fixing with joint



NSYCMUMA50

- Device allowing rotation through 170° of a horizontal tube, with a square section of 50 (1.97) or 80 (3.15) mm (in.), and its fixing on a vertical surface.
- Protection by bellows, RAL 7035 grey color.
- Possibility of passing cables through the inside of the joint.
- Material: Molded steel
- Color: RAL 7040 grey

For more details see [page 426](#)

Characteristics	Square mm (in.)	Weight kg (lbs.)	References
Wall fixing with joint	50 (1.97)	4.35 (9.59)	NSYCMUMA50
Wall fixing with joint	80 (3.15)	9.45 (20.83)	NSYCMUMA80

Rotating straight fitting



NSYCMUMC50

- Device allowing the fixing and rotation through 295° of tubes, with a square section of 50 (1.97) or 80 (3.15) mm (in.), in horizontal position.
- Without blocking the chosen position.
- Fixing by 4 screws, not included.
- Material: Molded steel
- Color: RAL 7040 grey

For more details see [page 426](#)

Characteristics	Square mm (in.)	Weight kg (lbs.)	References
Rotating straight fitting	50 (1.97)	5.4 (11.90)	NSYCMUMC50
Rotating straight fitting	80 (3.15)	15.7 (34.61)	NSYCMUMC80

Horizontal inter-tube joint



NSYCMUIA50

- Device allowing the linking and rotation through 170° of 2 horizontal tubes, with a square section of 50 (1.97) or 80 (3.15) mm (in.).
- Protection by bellows, RAL 7035 grey color.
- Possibility of passing cables through the inside of the joint.
- Material: Molded steel
- Color: RAL 7040 grey

For more details see [page 426](#)

Characteristics	Square mm (in.)	Weight kg (lbs.)	References
Horizontal inter-tube joint	50 (1.97)	4.25 (9.37)	NSYCMUIA50
Horizontal inter-tube joint	80 (3.15)	10 (22.05)	NSYCMUIA80

Adapter part for enclosure D 300 (11.81) / Ø 80 (3.15) mm (in.)

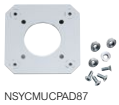

NSYCMUCPAD87

Characteristics	Square mm (in.)	Weight kg (lbs.)	References
Adapter part for enclosure D 300 (11.81) / Ø 80 (3.15) mm (in.)	80 (3.15)	0.5 (1.10)	NSYCMUCPAD87

Fixed bracket



NSYCMUTC50

- Our system of tubes and joints, fixed or rotating, enables all the solutions to respond to the installation needs of the control enclosures for human-machine dialogue.
- Device allowing the combination and fixing of a horizontal tube with a vertical tube.
- Material: Aluminum
- Color: RAL 7040 grey

For more details see [page 427](#)

Characteristics	Square mm (in.)	Weight kg (lbs.)	References
Fixed bracket	50 (1.97)	1.35 (2.98)	NSYCMUTC50
Fixed bracket	80 (3.15)	2.4 (5.29)	NSYCMUTC80

Rotating fixing on enclosure



NSYCMUCR50

- Device allowing the fixing and rotation through 300° of tubes, with a square section of 50 (1.97) or 80 (3.15) mm (in.), in vertical position.
- System for blocking in the chosen position.
- Fixing through the support surface by 4 screws.
- Material: Aluminum
- Color: RAL 7040 grey

For more details see [page 427](#)

Characteristics	Square mm (in.)	Weight kg (lbs.)	References
Rotating fixing on enclosure	50 (1.97)	1.25 (2.76)	NSYCMUCR50
Rotating fixing on enclosure	80 (3.15)	3.1 (6.83)	NSYCMUCR80

Rotating fixing in bracket on enclosure



NSYCMUCC50

- Devices allowing the fixing and rotation through 300° of tubes, with a square section of 50 (1.97) or 80 (3.15) mm (in.), in horizontal position.
- System for blocking in the chosen position.
- Fixing through the support surface by 4 screws.
- Material: Aluminum
- Color: RAL 7040 grey

For more details see [page 427](#)

Characteristics	Square mm (in.)	Weight kg (lbs.)	References
Rotating fixing in bracket on enclosure	50 (1.97)	2 (4.41)	NSYCMUCC50
Rotating fixing in bracket on enclosure	80 (3.15)	6.55 (14.44)	NSYCMUCC80

Tilting fixing on enclosure



NSYCMUCP50

- This fixing allows the enclosures to be tilted up to 30°.
- System for blocking in the chosen position.
- It is installed on enclosures with depths of 200 (7.87) and 250 (9.84) mm (in.).
- The installation on enclosures with a depth of 300 (11.81) mm (in.) requires an adapter plate.
- Material: Aluminum + PA
- Color: RAL 7040 grey + PA black

For more details see [page 427](#)

Characteristics	Square mm (in.)	Weight kg (lbs.)	References
Tilting fixing on enclosure	50 (1.97)	2.98 (6.57)	NSYCMUCP50
Tilting fixing on enclosure	80 (3.15)	3.10 (6.83)	NSYCMUCP80

Adapter for signalling beacon



NSYCMACS50

- It is installed on fixed brackets ref. NSYCMUTC50 and NSYCMUTC80.
- Material: Aluminum.
- Finish: Structured finish, powder.
- Color: RAL 7040 grey

For more details see [page 427](#)

Characteristics	Square mm (in.)	Weight kg (lbs.)	References
Adapter for signalling beacon	50 (1.97)	0.025 (0.06)	NSYCMACS50
Adapter for signalling beacon	80 (3.15)	0.08 (0.18)	NSYCMACS80

The range of **Spacial SD** control desks provides all functions required of a workstation intended for industrial and infrastructure applications.



Steel control desks



Accessibility

There are two versions of the Compact control desk:

- Front accessibility: Designed for straight-forward solutions.
- Front and rear accessibility through a removable panel: Enables the installation of two adjoining plates and to work at the rear. The control desk with console offers full accessibility since it is fully accessible from the rear thanks to the 3-point locking door it includes. For Spacial SD, the accessibility which allows quick and easy work is one of its main priorities. For this reason, its design excludes the central upright.



Convenience

The possibility of connecting the modular control desk to the modular consoles affords multiple combinations. The opening direction of the door can be changed quickly thanks to the included hinges.



Ease of use

The console opens easily and safely thanks to the installed pneumatic opening lid stays. Cable entry is optimized because all the models of the range include a cable gland plate with two adjustable parts.



Compatibility

Furthermore, the Spacial SD control desk is compatible with most of the accessories of the Spacial SF and SM ranges.

For details consult our web site
www.se.com

The combination of a monobloc control desk with one or more consoles enables all combinations. Complete accessibility to the inside of the control desk thanks to its design without intermediate crossbars.



Examples of associations

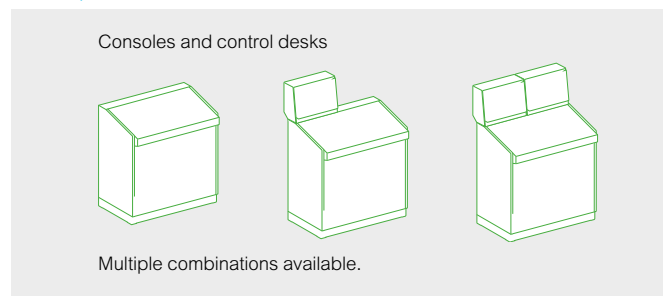

Stainless-steel control desks



Hygiene

The high quality of the standard finish enables very easy maintenance while avoiding contamination. The hygienic feet made from 316L stainless-steel, adjustable between 140 (5.51) mm (in.) and 200 (7.87) mm (in.) height, make it easier to clean under the enclosures.

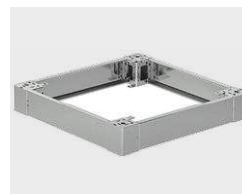

Compatibility with other ranges

Stainless-steel accessories:

- Plinths, locks.
- Accessories of the steel control desks offer:
 - Mounting plate, pneumatic opening stay, etc.



Resistance to corrosion

High resistance to corrosion. 304L and 316L stainless-steels provide the best solutions for applications in extremely demanding environments.



Convenience

The desk lid and the console are equipped with pneumatic opening stays (opening to 75°) allowing complete access to the inside and preventing sudden falls of the console or the hinged cover. Equipped with adjustment rails for adjusting the depth of the mounting plate. Removable rear panel.

For details consult our web site
www.se.com

Compact control desk



- This range is available in 4 widths with fixed rear panel.
- Full accessibility is provided from the front (no central upright).
- Easy removable and reversible door opening to 120°.
- Locking by 3 (0.12) mm (in.) doublebar lock (other inserts or cylinders also available, to be ordered separately, see [page 413](#)).
- Desk lid equipped with a pneumatic opening stay.
- Opens to 75°. Perforated reinforcement rails with a pitch of 25 (0.98) mm (in.).
- Control desk equipped with adjustment rails with a pitch of 25 (0.98) mm (in.) and brackets allowing adjustment of the mounting plate depth.
- Cable gland plate with 2 adjustable parts, with polyurethane gasket.
- M8 x 18 (0.71) mm (in.) earthing screw for equipotential connection between the door and the body.
- Material: Welded folded steel
- Finish: Structured finish, epoxy polyester powder
- Color: RAL 7035 grey
- Thickness: 15 (0.59)/10° mm (in.)
- Ingress protection rating according to IEC 60529: IP55
- Mechanical protection rating according to IEC 62262: IK10

Options:
It can also be equipped with a mounting plate, see [page 415](#)

For more details see [page 428](#)

Characteristics	No. doors	Width mm (in.)	Height mm (in.)	Depth mm (in.)	References
Compact control desk	1	600 (23.62)	1000 (39.37)	469 (18.46)	NSYS D6
Compact control desk	1	800 (31.50)	1000 (39.37)	469 (18.46)	NSYS D8
Compact control desk	2	1000 (39.37)	1000 (39.37)	469 (18.46)	NSYS D10
Compact control desk	2	1200 (47.24)	1000 (39.37)	469 (18.46)	NSYS D12

Control desk with console



- Full accessibility is provided from the front and rear.
- Easy removable and reversible front door, opening to 120°.
- Locking by two-point locks with 3 (0.12) mm (in.) double-bar insert.
- Desk lid equipped with a pneumatic opening stay. Opens to 75°.
- Perforated reinforcement rails with a pitch of 25 (0.98) mm (in.) for quick installation of cables and cable ducts.
- Locking by two-point locks with 3 (0.12) mm (in.) double-bar insert.
- Hinged console cover equipped with a pneumatic opening stay.
- Opens to 75°.
- Locking by two-point locks with 3 (0.12) mm (in.) double-bar insert.
- Easy removable and reversible rear door, opening to 120°.
- Locking by three-point lock with flat escutcheon, 5 (0.20) mm (in.) double-bar insert.
- One entry cable gland plate, with polyurethane gasket.
- Control desk equipped with adjustment rails with a pitch of 25 (0.98) mm (in.) and brackets allowing adjustment of the mounting plate depth.
- M8 x 18 (0.71) mm (in.) earthing screw for equipotential connection between the door and the body.
- Material: Welded folded steel
- Finish: Structured finish, epoxy polyester powder
- Color: RAL 7035 grey
- Thickness: 15 (0.59)/10° mm (in.)
- Ingress protection rating according to IEC 60529: IP55
- Mechanical protection rating according to IEC 62262: IK10

Options:
Plinth options see [page 411](#).
It can also be equipped with a mounting plate, see [page 415](#).
Locking system: Other inserts or cylinders also available, see [page 413](#).
The console can support the installation of a 14" display with an optional PC support plate, see [page 415](#).

For more details see [page 428](#)

Characteristics	No. Front doors	No. Rear doors	No. cable gland plates	Width mm (in.)	Height mm (in.)	Depth mm (in.)	References
Control desk with console	1	1	1	800 (31.50)	1400 (55.12)	845 (33.27)	NSYS DF88
Control desk with console	1	1	1	800 (31.50)	1400 (55.12)	1045 (41.14)	NSYS DF810
Control desk with console	2	2	1	1000 (39.37)	1400 (55.12)	845 (33.27)	NSYS DF108
Control desk with console	2	2	1	1000 (39.37)	1400 (55.12)	1045 (41.14)	NSYS DF1010
Control desk with console	2	2	1	1200 (47.24)	1400 (55.12)	845 (33.27)	NSYS DF128
Control desk with console	2	2	1	1200 (47.24)	1400 (55.12)	1045 (41.14)	NSYS DF1210
Control desk with console	2	2	2	1600 (62.99)	1400 (55.12)	845 (33.27)	NSYS DF168
Control desk with console	2	2	2	1600 (62.99)	1400 (55.12)	1045 (41.14)	NSYS DF1610

SD Compact control desk with rear panel

- Removable rear panel. It enables the installation of two mounting plates back-to-back, allowing the installation of a large number of devices, while ensuring full accessibility from the front and the rear.
- At the top, these control desks are equipped with cable entry cut-outs, that allows the installation of one or more modular consoles.
- Easy removable and reversible door, opening to 120°.
- Locking by 3 (0.12) mm (in.) doublebar lock (other inserts or cylinders also available, to be ordered separately, see [page 413](#)).
- Desk lid equipped with a pneumatic opening stay.
- Opens to 75°. Perforated reinforcement rails with a pitch of 25 (0.98) mm (in.).
- Top cable entry cut-outs covered by a entire blanking cover.
- Control desk equipped with adjustment rails with a pitch of 25 (0.98) mm (in.) and brackets allowing adjustment of the mounting plate depth.
- Cable gland plate with 2 adjustable parts, with polyurethane gasket.
- M8 x 18 (0.71) mm (in.) earthing screw for equipotential connection between the door and the body.
- Material: Welded folded steel
- Finish: Structured finish, epoxy polyester powder paint
- Color: RAL 7035 grey
- Thickness: 15 (0.59)/10° mm (in.)
- Ingress protection rating according to IEC 60529: IP55
- Mechanical protection rating according to IEC 62262: IK10



NSYS06R

Options:

Modular consoles to be installed on top of compact control desk. See details and combinations [page 407](#). It can also be equipped with a mounting plate, see [page 415](#).

For more details see [page 429](#)

Characteristics	No. doors	Width mm (in.)	Height mm (in.)	Depth mm (in.)	References
Compact control desk with rear panel	1	600 (23.62)	1000 (39.37)	600 (23.62)	NSYS06R
Compact control desk with rear panel	1	800 (31.50)	1000 (39.37)	600 (23.62)	NSYS08R
Compact control desk with rear panel	2	1000 (39.37)	1000 (39.37)	600 (23.62)	NSYS10R
Compact control desk with rear panel	2	1200 (47.24)	1000 (39.37)	600 (23.62)	NSYS12R

SDX Compact control desk with rear panel

- Removable rear panel. It enables the installation of two mounting plates back-to-back, allowing the installation of a large number of devices, while ensuring full accessibility from the front and the rear.
- At the top, these control desks are equipped with cable entry cut-outs, that allows the installation of one or more modular consoles.
- Easy removable and reversible door, opening to 120°.
- Locking by 3 (0.12) mm (in.) doublebar lock (other inserts or cylinders also available, to be ordered separately, see [page 413](#)).
- Desk lid equipped with a pneumatic opening stay.
- Opens to 75°. Perforated reinforcement rails with a pitch of 25 (0.98) mm (in.).
- Top cable entry cut-outs covered by a entire blanking cover.
- Control desk equipped with adjustment rails with a pitch of 25 (0.98) mm (in.) and brackets allowing adjustment of the mounting plate depth.
- Cable gland plate with 2 adjustable parts, with polyurethane gasket.
- M8 x 18 (0.71) mm (in.) earthing screw for equipotential connection between the door and the body.
- Material: 304L stainless-steel
- Finish: Scotch-Brite® brushed finish
- Thickness: 15 (0.59)/10° mm (in.)
- Ingress protection rating according to IEC 60529: IP55
- Mechanical protection rating according to IEC 62262: IK10



NSYS06S

Options:

Stainless-steel modular consoles to be installed on top of compact control desk. See details and combinations [page 407](#). It can also be equipped with a mounting plate, see [page 415](#).

For more details see [page 429](#)

Characteristics	No. doors	Width mm (in.)	Height mm (in.)	Depth mm (in.)	References
Compact control desk with rear panel	1	600 (23.62)	1000 (39.37)	500 (19.68)	NSYS06S
Compact control desk with rear panel	1	800 (31.50)	1000 (39.37)	500 (19.68)	NSYS08S
Compact control desk with rear panel	2	1000 (39.37)	1000 (39.37)	500 (19.68)	NSYS10S
Compact control desk with rear panel	2	1200 (47.24)	1000 (39.37)	500 (19.68)	NSYS12S

SD Modular consoles

- Hinged modular console cover equipped with a pneumatic opening stay.
- Opens to 75°. Locking of the hinged modular console cover by two 3 (0.12) mm (in.) double-bar locks (other inserts or barrels also available, to be ordered separately, see [page 413](#)).
- Screw fixed rear panel equipped with step slides in the version with a depth of 300 (11.81) mm (in.).
- Material: Welded folded steel
- Finish: Structured finish, epoxy polyester powder
- Color: RAL 7035 grey
- Thickness: 15 (0.59)/10^e mm (in.)
- Ingress protection rating: IP55 according to IEC 60529
- Mechanical protection rating: IK10 according to IEC 62262

Options:

The link between the control desk and the modular console requires, in certain cases, the addition of one or several blanking covers (to be ordered separately).
Optional galvanized mounting plate.



NSYSDC42

Characteristics	No. of cable entry cut-outs	Width mm (in.)	Height mm (in.)	Depth mm (in.)	References
Modular consoles	2	400 (15.75)	483 (19.02)	200 (7.87)	NSYSDC42
Modular consoles	2	400 (15.75)	483 (19.02)	300 (11.81)	NSYSDC43
Modular consoles	3	600 (23.62)	483 (19.02)	200 (7.87)	NSYSDC62
Modular consoles	3	600 (23.62)	483 (19.02)	300 (11.81)	NSYSDC63

SDX Modular consoles

- Hinged modular console cover equipped with a pneumatic opening stay.
- Opens to 75°. Locking of the hinged modular console cover by two 3 (0.12) mm (in.) double-bar locks (other inserts or barrels also available, to be ordered separately, see [page 413](#)).
- Screw fixed rear panel equipped with step slides in the version with a depth of 300 (11.81) mm (in.).
- Material: 304L stainless-steel
- Finish: Scotch-Brite® brushed finish
- Thickness: 15 (0.59)/10^e mm (in.)
- Ingress protection rating: IP55 according to IEC 60529
- Mechanical protection rating: IK10 according to IEC 62262

Options:

The link between the control desk and the modular console requires, in certain cases, the addition of one or several blanking covers (to be ordered separately).
Optional galvanized mounting plate.



NSYSDCX42

Characteristics	No. of cable entry cut-outs	Width mm (in.)	Height mm (in.)	Depth mm (in.)	References
Modular consoles	2	400 (15.75)	483 (19.02)	200 (7.87)	NSYSDCX42
Modular consoles	2	400 (15.75)	483 (19.02)	300 (11.81)	NSYSDCX43
Modular consoles	3	600 (23.62)	483 (19.02)	200 (7.87)	NSYSDCX62
Modular consoles	3	600 (23.62)	483 (19.02)	300 (11.81)	NSYSDCX63

SD Blanking cover

- To conceal the free space of the control desk when the width of the console or consoles is less than the width of the control desk.
- In any case, it is necessary to first remove the top plate delivered with the control desk.
- Material: Steel
- Finish: Structured finish, epoxy polyester powder
- Color: RAL 7035 grey
- Thickness: 15 (0.59)/10^e mm (in.)
- Fixing: Fixing by screws



NSYRP2

Characteristics	Width mm (in.)	Height mm (in.)	References
Blanking cover	200 (7.87)	40 (1.58)	NSYRP2

SDX Blanking cover

- To conceal the free space of the control desk when the width of the console or consoles is less than the width of the control desk.
- In any case, it is necessary to first remove the top plate delivered with the control desk.
- Material: 304L stainless-steel
- Thickness: 15 (0.59)/10^e mm (in.)
- Fixing: Fixing by screws



NSYRPX2

Characteristics	Width mm (in.)	Height mm (in.)	References
Blanking cover	200 (7.87)	40 (1.58)	NSYRPX2

Mounting plates for modular consoles

- Steel mounting plates can be installed at the back of modular consoles (F).
- Material: 304L Galvanized Steel

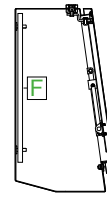

Example installation of a mounting plate in a console depth 200 (7.87) mm (in.).

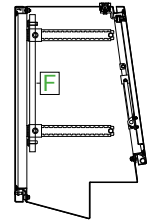

Example installation of a mounting plate in a console depth 300 (11.81) mm (in.).



NSYMM44

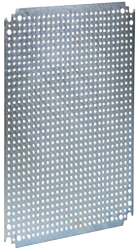

NSYMF44



NSYMR44

Characteristics	Modular console Width mm (in.)	Fixing center-to-center distance		References
		Height mm (in.)	Width mm (in.)	
Mounting plate	400 (15.75)	325 (12.80)	325 (12.80)	NSYMM44
Mounting plate	600 (23.62)	625 (24.61)	325 (12.80)	NSYMM64

Characteristics	Modular console Width mm (in.)	Fixing center-to-center distance		References
		Height mm (in.)	Width mm (in.)	
Mounting plate Microperforated	400 (15.75)	325 (12.80)	325 (12.80)	NSYMF44
Mounting plate Microperforated	600 (23.62)	625 (24.61)	325 (12.80)	NSYMF64

Characteristics	Modular console Width mm (in.)	Fixing center-to-center distance		References
		Height mm (in.)	Width mm (in.)	
Mounting plate Telequick	400 (15.75)	325 (12.80)	325 (12.80)	NSYMR44
Mounting plate Telequick	600 (23.62)	625 (24.61)	325 (12.80)	NSYMR64

Combination examples of modular consoles installation		Compact control desk		Modular console		Blanking cover	
600 (23.62) mm (in.)		Spacial SD	Spacial SDX	Spacial SD	Spacial SDX	Spacial SD	Spacial SDX
		NSYSD6R	NSYSDX6	NSYSDC42 / NSYSDC43	NSYSDCX42 / NSYSDCX43	NSYRP2	NSYRPX2
		NSYSD6R	NSYSDX6	NSYSDC62 / NSYSDC63	NSYSDCX62 / NSYSDCX63	-	-
800 (31.50) mm (in.)		Spacial SD	Spacial SDX	Spacial SD	Spacial SDX	Spacial SD	Spacial SDX
		NSYSD8R	NSYSDX8	NSYSDC42 / NSYSDC43	NSYSDCX42 / NSYSDCX43	2 x NSYRP2	2 x NSYRPX2
		NSYSD8R	NSYSDX8	2 x NSYSDC42 / 2 x NSYSDC43	2 x NSYSDCX42 / 2 x NSYSDCX43	-	-
		NSYSD8R	NSYSDX8	NSYSDC62 / NSYSDC63	NSYSDCX62 / NSYSDCX63	NSYRP2	NSYRPX2
1000 (39.37) mm (in.)		Spacial SD	Spacial SDX	Spacial SD	Spacial SDX	Spacial SD	Spacial SDX
		NSYSD10R	NSYSDX10	NSYSDC42 / NSYSDC43	NSYSDCX42 / NSYSDCX43	3 x NSYRP2	3 x NSYRPX2
		NSYSD10R	NSYSDX10	NSYSDC62 / NSYSDC63	NSYSDCX62 / NSYSDCX63	2 x NSYRP2	2 x NSYRPX2
		NSYSD10R	NSYSDX10	NSYSDC62 / NSYSDC63	NSYSDCX62 / NSYSDCX63	2 x NSYRP2	2 x NSYRPX2
		NSYSD10R	NSYSDX10	NSYSDC42 + NSYSDC62 / NSYSDC43 + NSYSDC63	NSYSDCX42 + NSYSDCX62 / NSYSDCX43 + NSYSDCX63	-	-
1200 (47.24) mm (in.)		Spacial SD	Spacial SDX	Spacial SD	Spacial SDX	Spacial SD	Spacial SDX
		NSYSD12R	NSYSDX12	NSYSDC42 / NSYSDC43	NSYSDCX42 / NSYSDCX43	4 x NSYRP2	4 x NSYRPX2
		NSYSD12R	NSYSDX12	NSYSDC62 / NSYSDC63	NSYSDCX62 / NSYSDCX63	3 x NSYRP2	3 x NSYRPX2
		NSYSD12R	NSYSDX12	NSYSDC62 / NSYSDC63	NSYSDCX62 / NSYSDCX63	3 x NSYRP2	3 x NSYRPX2
		NSYSD12R	NSYSDX12	2 x NSYSDC62 / 2 x NSYSDC63	2 x NSYSDCX62 / 2 x NSYSDCX63	-	-
		NSYSD12R	NSYSDX12	NSYSDC42 + NSYSDC62 / NSYSDC43 + NSYSDC63	NSYSDCX42 + NSYSDCX62 / NSYSDCX43 + NSYSDCX63	NSYRP2	NSYRPX2

Floor

SD

SDX

For more information, see [page 110](#).



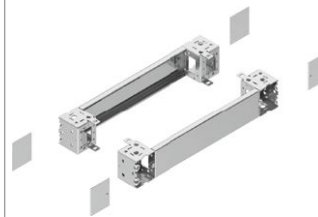

Front and rear plinth



Characteristics	NSYSPF6100	NSYSPFX6100
	<ul style="list-style-type: none"> The front and rear of the plinth consists of 4 corners with 2 or 4 panels. 	
Material	Folded sheet steel, corner with a thickness of 25 (0.98)/10° mm (in.)	304L stainless-steel
Finish	Painted with epoxy polyester resin	-
Color	RAL 7022 grey	-
Ingress protection rating	IP30	IP30
Mechanical protection rating	IK10	IK10
Supply	<ul style="list-style-type: none"> Height 100 (3.94) mm (in.): 4 corners, 2 panels (front and rear), 4 corner covers and fixing elements Height 200 (7.87) mm (in.): 4 corners, 4 panels (2 front and 2 rear), 4 corner covers and fixing elements The use of 304L stainless-steel plinths on an SD control desk requires an earthing cable reference NSYEL226D13 (description page 303) to be ordered separately. 	

Control desk references	Plinths references			
Compact control desks with fixed rear panel	100 (3.94) mm (in.)	200 (7.87) mm (in.)	100 (3.94) mm (in.)	200 (7.87) mm (in.)
References	References	References	References	References
 NSYSD6	NSYSPF6100	NSYSPF6200	NSYSPFX6100	NSYSPFX6200
NSYSD8	NSYSPF8100	NSYSPF8200	NSYSPFX8100	NSYSPFX8200
NSYSD10	NSYSPF10100	NSYSPF10200	NSYSPFX10100	NSYSPFX10200
NSYSD12	NSYSPF12100	NSYSPF12200	NSYSPFX12100	NSYSPFX12200

Compact control desks with removable rear panel Sheet steel	100 (3.94) mm (in.)	200 (7.87) mm (in.)	100 (3.94) mm (in.)	200 (7.87) mm (in.)
References	References	References	References	References
 NSYSD6R	NSYSPF6100	NSYSPF6200	NSYSPFX6100	NSYSPFX6200
NSYSD8R	NSYSPF8100	NSYSPF8200	NSYSPFX8100	NSYSPFX8200
NSYSD10R	NSYSPF10100	NSYSPF10200	NSYSPFX10100	NSYSPFX10200
NSYSD12R	NSYSPF12100	NSYSPF12200	NSYSPFX12100	NSYSPFX12200

Compact control desks with removable rear panel Stainless-steel	100 (3.94) mm (in.)	200 (7.87) mm (in.)	100 (3.94) mm (in.)	200 (7.87) mm (in.)
References	References	References	References	References
 NSYSDX6	-	-	NSYSPFX6100	NSYSPFX6200
NSYSDX8	-	-	NSYSPFX8100	NSYSPFX8200
NSYSDX10	-	-	NSYSPFX10100	NSYSPFX10200
NSYSDX12	-	-	NSYSPFX12100	NSYSPFX12200

Control desk with console	100 (3.94) mm (in.)	200 (7.87) mm (in.)	100 (3.94) mm (in.)	200 (7.87) mm (in.)
References	References	References	References	References
 NSYSDF88	NSYSPF8100	NSYSPF8200	-	-
NSYSDF108	NSYSPF10100	NSYSPF10200	-	-
NSYSDF128	NSYSPF12100	NSYSPF12200	-	-
NSYSDF168	NSYSPF16100	NSYSPF16200	-	-
NSYSDF810	NSYSPF8100	NSYSPF8200	-	-
NSYSDF1010	NSYSPF10100	NSYSPF10200	-	-
NSYSDF1210	NSYSPF12100	NSYSPF12200	-	-
NSYSDF1610	NSYSPF16100	NSYSPF16200	-	-



Plinth side panels



NSYSPS4100SD		NSYSPSX5100	
<ul style="list-style-type: none"> They are fixed to the corner of the plinth by 2 fixing screws. 			
Folded sheet steel		304L stainless-steel	
Painted with epoxy polyester resin		-	
RAL 7022 grey		-	
IP30		IP30	
IK10		IK10	
<ul style="list-style-type: none"> Height 100 (3.94) mm (in.): 2 side panels, 4 corner covers and fixing elements Height 200 (7.87) mm (in.): 4 side panels (height of 100 (3.94) mm (in.), 2 for each side), 4 corner covers and fixing elements The use of 304L stainless-steel plinths on an SD control desk requires an earthing cable reference NSYEL226D13 (description page 303) to be ordered separately. 			

100 (3.94) mm (in.) References	200 (7.87) mm (in.) References	100 (3.94) mm (in.) References	200 (7.87) mm (in.) References
NSYSPS4100SD	NSYSPS4200SD	NSYSPSX5100	NSYSPSX5200
NSYSPS4100SD	NSYSPS4200SD	NSYSPSX5100	NSYSPSX5200
NSYSPS4100SD	NSYSPS4200SD	NSYSPSX5100	NSYSPSX5200
NSYSPS4100SD	NSYSPS4200SD	NSYSPSX5100	NSYSPSX5200

100 (3.94) mm (in.) References	200 (7.87) mm (in.) References	100 (3.94) mm (in.) References	200 (7.87) mm (in.) References
NSYSPS5100SD	NSYSPS5200SD	NSYSPSX5100	NSYSPSX5200
NSYSPS5100SD	NSYSPS5200SD	NSYSPSX5100	NSYSPSX5200
NSYSPS5100SD	NSYSPS5200SD	NSYSPSX5100	NSYSPSX5200
NSYSPS5100SD	NSYSPS5200SD	NSYSPSX5100	NSYSPSX5200

100 (3.94) mm (in.) References	200 (7.87) mm (in.) References	100 (3.94) mm (in.) References	200 (7.87) mm (in.) References
-	-	NSYSPSX5100	NSYSPSX5200
-	-	NSYSPSX5100	NSYSPSX5200
-	-	NSYSPSX5100	NSYSPSX5200
-	-	NSYSPSX5100	NSYSPSX5200

100 (3.94) mm (in.) References	200 (7.87) mm (in.) References	100 (3.94) mm (in.) References	200 (7.87) mm (in.) References
NSYSPS4100SD	NSYSPS4200SD	-	-
NSYSPS4100SD	NSYSPS4200SD	-	-
NSYSPS4100SD	NSYSPS4200SD	-	-
NSYSPS4100SD	NSYSPS4200SD	-	-
NSYSPS6100SD	NSYSPS6200SD	-	-
NSYSPS6100SD	NSYSPS6200SD	-	-
NSYSPS6100SD	NSYSPS6200SD	-	-
NSYSPS6100SD	NSYSPS6200SD	-	-

Door

Pneumatic opening stay

- Holds the desk lid in open position at an angle of 75°.



Nominal load per stay (N) mm (in.)	Max. load on lid kg (lbs.)	Control desk references				Standard supply stay
		With fixed rear panel References	With removable rear panel Sheet steel References	With removable rear panel Stainless-steel References	With console References	
244 (9.61)	13 (28.66)	NSYSD6	NSYSD6R	NSYSDX6	NSYSDF88	NSYPLS24
244 (9.61)	13 (28.66)	NSYSD8	NSYSD8R	NSYSDX8	NSYSDF810	NSYPLS24
300 (11.81)	11 (24.25)	-	-	-	NSYSDF168	NSYPLS30
300 (11.81)	11 (24.25)	-	-	-	NSYSDF1610	NSYPLS30
300 (11.81)	15 (33.07)	NSYSD12	NSYSD12R	NSYSDX12	NSYSDF128	NSYPLS30
300 (11.81)	15 (33.07)	-	-	-	NSYSDF1210	NSYPLS30
300 (11.81)	17 (37.48)	NSYSD10	NSYSD10R	NSYSDX10	NSYSDF108	NSYPLS30
300 (11.81)	17 (37.48)	-	-	-	NSYSDF1010	NSYPLS30

Pneumatic opening stay

- Holds the desk lid in open position at an angle of 75°.

Supply:
delivered with fixings



Characteristics	Nominal load per stay (N) mm (in.)	Max. load on lid kg (lbs.)	References
Pneumatic opening stay	244 (9.61)	13 (28.66)	NSYPLS24
Pneumatic opening stay	300 (11.81)	17 (37.48)	NSYPLS30

Shape inserts

Possibility to replace the standard shape insert:

- 8 (0.32) mm (in.) triangular insert,
- 8 (0.32) mm (in.) male square insert,
- 7 (0.28) mm (in.) male square insert.
- Material: Zamack

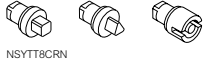

NSYTT8CRN

Characteristics	References
8 (0.32) mm (in.) triangular insert	NSYTT8CRN
8 (0.32) mm (in.) male square insert	NSYTC8CRN
7 (0.28) mm (in.) male square insert	NSYTC7CRN

Escutcheon with key lock

- Insert breakage torque: 15 daN.
- Material: Polyamide PA 6 material charged with 30% fiberglass
- Color: RAL 7011 grey
- Mechanical protection rating according to IEC 62262: IK10
- Fire resistance: 650°C (1202°F)



NSYML405SD

Characteristics	References
405E key	NSYML405SD

Pivoting handle

- To be installed on the rear door of Control desk with console, replacing the flat escutcheon supplied as standard.
- Ergonomic locking system with pivoting handle (delivered without insert).
- Broad range of inserts for covering the greatest variety of needs (shape inserts, DIN cylinders, KABA, ASSA).
- Changing the opening direction to right / left thanks to the symmetric design of the lock unit (no linkages to be removed).
- Lock unit supported by 2 screws.
- Material: PA 6 charged with 30% fiberglass
- Color: RAL 7011 grey
- Mechanical protection rating according to IEC 62262: IK10
- Fire resistance: 650°C (1202°F)



NSYS DH

Characteristics	References
Without insert	NSYS DH

Shape inserts

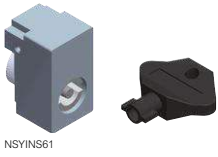

NSYINS61

Characteristics	References
6 (0.24) mm (in.) square insert	NSYINS61
7 (0.28) mm (in.) square insert	NSYINS71
8 (0.32) mm (in.) square insert	NSYINS81
Female 8 (0.32) mm (in.) square insert	NSYINS8G1
6.5 (0.26) mm (in.) triangular insert	NSYINT61
7 (0.28) mm (in.) triangular insert	NSYINT71
8 (0.32) mm (in.) triangular insert	NSYINT81
9 (0.35) mm (in.) triangular insert	NSYINT91
10 (0.39) mm (in.) triangular insert	NSYINT101
3 (0.12) mm (in.) double-bar insert	NSYINDB31
5 (0.20) mm (in.) double-bar insert	NSYINDB51

Push-button



NSYINPULSD

Characteristics	References
Push-button	NSYINPULSD

Cylindrical barrels

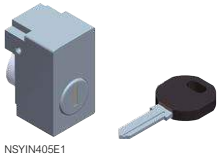

NSYIN405E1

Characteristics	References
405E key lock	NSYIN405E1
421E key lock	NSYIN421E1
455 key lock	NSYIN4551
1242E key lock	NSYIN1242E1
1332E key lock	NSYIN1332E1
2124E key lock	NSYIN2124E1
2131A key lock	NSYIN2131A1
2132A key lock	NSYIN2132A1
2331A key lock	NSYIN2331A1
2433A key lock	NSYIN2433A1
2452E key lock	NSYIN2452E1
3113A key lock	NSYIN3113A1
3122E key lock	NSYIN3122E1
3123A key lock	NSYIN3123A1
3131A1 key lock	NSYIN3131A1
3133A key lock	NSYIN3133A1
3422E key lock	NSYIN3422E1
3432E key lock	NSYIN3432E1
6101 key lock	NSYIN6101
EDF1300 key lock	NSYINF1301
EDF1400 key lock	NSYINF1401
Michelin 8133 keyless lock	NSYINICHEL8131
Michelin 8376 keyless lock	NSYINICHEL8371
E1 keyless lock	NSYINE11

Compact control desks

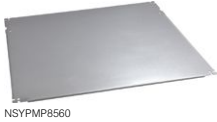
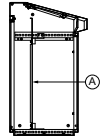

Characteristics	Width mm (in.)	Surface (dm ²)	References
Mounting plate plain	600 (23.62)	42	NSYPMP8560
Mounting plate plain	800 (31.50)	59	NSYPMP8580
Mounting plate plain	1000 (39.37)	76	NSYPMP85100
Mounting plate plain	1200 (47.24)	93	NSYPMP85120

Control desk with console

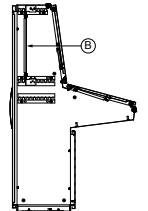

Characteristics	Width mm (in.)	Surface (dm ²)	References
Mounting plate plain	800 (31.50)	31	NSYPMP4580
Mounting plate plain	1000 (39.37)	40	NSYPMP45100
Mounting plate plain	1200 (47.24)	77	NSYPMP45120
Mounting plate plain	1600 (62.99)	67	NSYPMP45160

Control desk with console

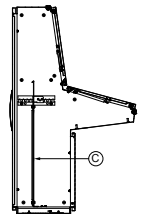

Characteristics	Width mm (in.)	Surface (dm ²)	References
Mounting plate plain	800 (31.50)	49	NSYPMP8580
Mounting plate plain	1000 (39.37)	63	NSYPMP85100
Mounting plate plain	1200 (47.24)	77	NSYPMP85120
Mounting plate plain	1600 (62.99)	105	NSYPMP85160

Compact control desks



NSYMP148

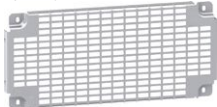

NSYSTMP6080

Characteristics	Width mm (in.)	Surface (dm ²)	References
Mounting plate plain	800 (31.50)	90	NSYMP148
Mounting plate plain	1000 (39.37)	116	NSYMP1410
Mounting plate plain	1200 (47.24)	142	NSYMP1412
Mounting plate Telequick (2 items needed)	800 (31.50)	84	NSYSTMP6080
Mounting plate Telequick (2 items needed)	1000 (39.37)	108	NSYSTMP60100
Mounting plate Telequick (2 items needed)	1200 (47.24)	132	NSYSTMP60120

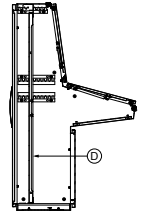

Compact control desks



NSYSPMP4080

Characteristics	Width mm (in.)	Surface (dm ²)	References
Mounting plate plain	800 (31.50)	28	NSYSPMP4080
Mounting plate plain	1000 (39.37)	36	NSYSPMP40100
Mounting plate plain	1200 (47.24)	44	NSYSPMP40120
Mounting plate plain	1600 (62.99)	60	NSYSPMP40160

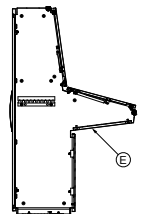

Fixing brackets

- Set of 4 fixing brackets.
- Depth adjustment on 25 (0.98) mm (in.) pitch.
- Included as standard with desk (all versions).
- To be ordered separately when required for installation of two back-to-back mounting plates in control desks with rear access.
- Material: Galvanized steel
- Thickness: 40 (1.58)/10° mm (in.)
- Maximum load: 250 (551.16) kg (lbs.)



NSYMPBSD

Characteristics	For desk width mm (in.)	References
Fixing brackets	600 (23.62)	NSYMPBSD
Fixing brackets	800 (31.50)	NSYMPBSD
Fixing brackets	1000 (39.37)	NSYMPBSD
Fixing brackets	1200 (47.24)	NSYMPBSD
Fixing brackets	1600 (62.99)	NSYMPBSD

Adjustment rails and fixing brackets

- Set of 4 rails and 4 fixing brackets.
- To install a plain mounting plate or a Telequick mounting plate, either at the top or across the height of the monobloc control desk with console.
- For positioning 2 plates (back-to-back), order fixing brackets ref. **NSYMPBSD**.



NSYMPB4SD

Characteristics	For control desks with console Depth mm (in.)	References
Adjustment rails and fixing brackets	400 (15.75)	NSYMPB4SD
Adjustment rails and fixing brackets	600 (23.62)	NSYMPB6SD

Technical uprights

- Set of 2 equipment uprights.
- Support for fixing Telequick mounting plates and rails.
- Material: Zinc-coated
- Thickness: 20 (0.79)/10° mm (in.)



Characteristics	For control desk height mm (in.)	Center-to-center distance mm (in.)	References
Technical uprights	1000 (39.37)	650 (25.59)	NSYTVR8
Technical uprights	1400 (55.12)	1250 (49.21)	NSYTVR14

The **Spacial SF** PC rack is designed to protect and control computer equipment in industrial environments.



Steel PC racks



Convenience

- Anti-glare glazed door designed for viewing displays up to 25.5"
- Cable entry made easier by a two-piece cable-land plate.

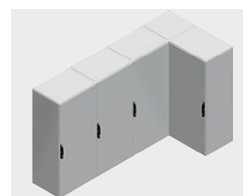

Simplicity

The Spacial SF design allows enclosures to be coupled in any direction, adapting to all installation surfaces.



Ergonomics

- Access to the various functions and working heights, guaranteeing optimal comfort.
- Partial doors delimit the access to each function with a 3 (0.12) mm (in.) double-bar lock.
- Built-in display and CPU support.
- Built-in keyboard and mouse support.



Detail of 5 (0.20) mm (in.) DB lock on rear door.

Locking system

- Locking system with flat escutcheon, made from polyamide 6 with 30% fiberglass, RAL 9005 black, with 5 (0.20) mm (in.) double-bar insert for the plain rear door, and small flat escutcheon with 3 (0.12) mm (in.) double-bar insert for the partial front doors.

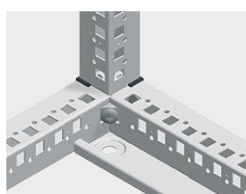

Robust

- Spacial SF structure formed from a single 1.5 (0.06) mm (in.) galvanized steel section, with a high moment of inertia.
- Vertical uprights joined with top and bottom frames, screwed together with connections of sintered steel.
- Panels built into the structure.

For details consult our web site
www.se.com

Spacial SF PC rack



NSYSF16660PC

- Partial door for PC display, with Securit® anti-glare glass.
- Plain partial door for CPU (enclosures with height of 1800 (70.87) mm (in.)).
- Hinged plain door for keyboard.
- Plain partial door for optional installation of A4 printer support.
- Partial front doors opening to the right.
- Plain rear door, reversible opening direction (right or left).
- Roof and side panels fixed from the inside.
- Cable gland plate with 1 entry.
- Finish: Structured finish, epoxy polyester powder
- Color: RAL 7035 grey
- Ingress protection rating according to IEC 60529: IP40
- Mechanical protection rating according to IEC 62262: IK10
- Certifications: UL 508A Types 1, 12 and CUL

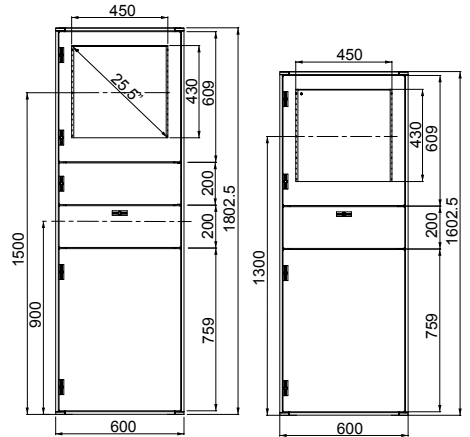

For more details see [page 429](#)

Characteristics	No. of compartments	Height mm (in.)	Width mm (in.)	Depth mm (in.)	References
Spacial SF PC rack	3	1600 (62.99)	600 (23.62)	600 (23.62)	NSYSF16660PC
Spacial SF PC rack	3	1600 (62.99)	600 (23.62)	800 (31.50)	NSYSF16680PC
Spacial SF PC rack	4	1800 (70.87)	600 (23.62)	600 (23.62)	NSYSF18660PC
Spacial SF PC rack	4	1800 (70.87)	600 (23.62)	800 (31.50)	NSYSF18680PC

Front and rear plinths



- The front and rear of the plinth consists of 4 corners with 2 or 4 panels.
- Material: Folded sheet steel, corner with a thickness of 25 (0.98)/10° mm (in.)
- Finish: Structured finish, epoxy polyester powder
- Color: RAL 7022 grey
- Ingress protection rating: IP30 according to IEC 60529
- Mechanical protection rating: IK10 according to IEC 62262

Supply:

Height 100 (3.94) mm (in.): 4 corners, 2 panels (front and rear), 4 corner covers and fixing elements
 Height 200 (7.87) mm (in.): 4 corners, 4 panels (2 front and 2 rear), 4 corner covers and fixing elements

Characteristics	Height mm (in.)	Width mm (in.)	References
Front plinths for Spacial	100 (3.94)	600 (23.62)	NSYSPF6100
Front plinths for Spacial	200 (7.87)	600 (23.62)	NSYSPF6200

Plinth side panels



- They are fixed to the corner of the plinth by 2 fixing screws.
- Material: Folded sheet steel
- Finish: Structured finish, epoxy polyester powder
- Color: RAL 7022 grey
- Ingress protection rating: IP30 according to IEC 60529
- Mechanical protection rating: IK10 according to IEC 62262

Supply:

Height 100 (3.94) mm (in.): 2 side panels, 4 corner covers and fixing elements
 Height 200 (7.87) mm (in.): 4 side panels (height of 100 (3.94) mm (in.), 2 for each side), 4 corner covers and fixing elements

Characteristics	Height mm (in.)	Depth mm (in.)	References
Side plinths for Spacial	100 (3.94)	600 (23.62)	NSYSPS6100
Side plinths for Spacial	100 (3.94)	800 (31.50)	NSYSPS8100
Side plinths for Spacial	200 (7.87)	600 (23.62)	NSYSPS6200
Side plinths for Spacial	200 (7.87)	800 (31.50)	NSYSPS8200

Fixed Trays



- Optional installation of a supplement fixed or telescopic tray directly on structure or on cross-rails.
- Acceptable load: 150 (330.69) kg (lbs.) for fixed trays and 50 (110.23) kg (lbs.) for telescopic rails, both evenly distributed.
- Installation: On structure / On cross-rails

For more details and other options on Mounting see page 259.

Characteristics	Width mm (in.)	Depth mm (in.)	References
Fixed Tray	600 (23.62)	600 (23.62)	NSYFXT6060

Universal cross-rail 40 (1.58) mm (in.) (1 row)



Characteristics	Enclosure Depth mm (in.)	References
Universal cross-rail 40 (1.58) mm (in.) (1 row)	600 (23.62)	NSYSUCR4060
Universal cross-rail 40 (1.58) mm (in.) (1 row)	800 (31.50)	NSYSUCR4080

Telescopic rails



Characteristics	Enclosure Depth mm (in.)	References
Telescopic rails	600 (23.62)	NSYTTG60
Telescopic rails	800 (31.50)	NSYTTG60

Handle for telescopic trays



- Handle designed for easy extraction of the sliding trays.
- Material: Polyamide 6 (black)

Supply:

2 units and fixing elements

Characteristics	References
Handle for telescopic trays	NSY1TH

Locks for partial doors

Locks to replace the 3 (0.12) mm (in.) double-bar lock supplied with the partial doors.

Models:

- Transformation of lock with shaped inserts, triangular 6.5 (0.26) mm (in.) and square 6 (0.24) mm (in.).
- Lock with 2233X key for partial doors.
- Lock with 2233X key, exclusive for hinged keyboard door.

Supply:

Lock with shaped inserts, triangular 6.5 (0.26) mm (in.) and square 6 (0.24) mm (in.): Metal body, shape insert and safety washer.

Lock with 2233X key for partial doors: metal body, insert, screw, safety washer and key.

Lock with 2233X key, exclusive for hinged keyboard door: Metal body, insert, special screw, safety washer and key.



Characteristics	References
With 6.5 (0.26) mm (in.) triangular insert for partial and hinged door	NSYMLT6
With 6 (0.24) mm (in.) square insert for partial and hinged door	NSYMLS6
With 2233X key for partial door	NSYML23
With 2233X key for hinged keyboard door	NSYMLCD23

The stainless-steel monobloc PC racks have been especially designed to protect computer equipment installed in corrosive or specially environments that require washing or exposure to sprays of liquid.



Stainless-steel monobloc PC racks



Convenience

- Anti-glare glazed door designed for viewing 14" and 17" displays by removing part of the silkscreen printing.
- Cable entry made easier by a cable gland plate (at the rear) in 2 pieces.



Ergonomics

- Partial doors delimit the access to each function with a 3 (0.12) mm (in.) double-bar lock.
- Access to the various functions and working heights, guaranteeing optimal comfort.
- Built-in display and CPU support.
- Built-in mouse support.



Sealing

- IP55, even with the keyboard drawer open, thanks to the pivoting Plexiglas shutter.



Hygiene

- The high quality of the standard finish enables very easy maintenance while avoiding contamination.
- The hygienic feet made from 316L stainless-steel, adjustable between 140 (5.51) mm (in.) and 200 (7.87) mm (in.) height, make it easier to clean under the enclosures, ref. **NSYPHX200**. More information on [page 165](#).



Optional accessories

- Shelf mounted on telescopic rails.



Resistance to corrosion

- High resistance to corrosion. 304L and 316L stainless-steels provide the best solutions for applications in extremely demanding environments.

For details consult our web site www.se.com

304L stainless-steel PC racks



NSYSMX16660PC

Composition

- Top and bottom partial doors on the front side.
- Pivoting panel for the keyboard.
- Plain rear door.

Monitor-display compartment

- The anti-glare glazed door is designed for viewing displays:
- 14" as standard, 17" by removing a part of the silkscreen printing.
- The height of the monitor support can be adjusted.
- The monitor shelf can withstand a maximum weight of 50 (110.23) kg (lbs).

CPU / keyboard compartment

- The keyboard fixed to the inside becomes operational by tilting the central panel.
- The CPU is placed on a height-adjustable shelf, visible and accessible through a pivoting, transparent shutter.

Optional accessories

- Hygienic feet H 200 (7.87) mm (in.): **NSYPHX200**.
- Shelf installed on a sliding rail, with adjustable height.
- Telescopic tray: **NSYTTG60**.
- Material: Monobloc structure in 304L stainless-steel sheet, micro-beaded finish. Can be made in 316L stainless-steel on request
- Ingress protection rating according to IEC 60529: IP55, even with the keyboard drawer open
- Mechanical protection rating according to IEC 62262: IK10

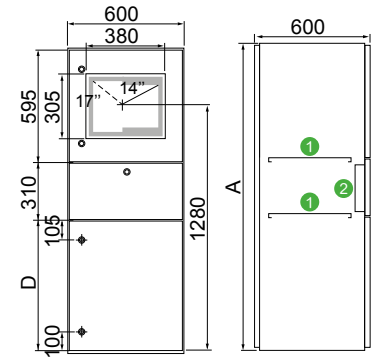

A: 1600 / 1800

B: 690 / 890

① Screwed shelf, adjustable height.

② Sealed case for keyboard.

Characteristics	Height mm (in.)	Width mm (in.)	Depth mm (in.)	References
304L stainless-steel PC racks	1600 (62.99)	600 (23.62)	600 (23.62)	NSYSMX16660PC
304L stainless-steel PC racks	1800 (70.87)	600 (23.62)	600 (23.62)	NSYSMX18660PC

Plinth

- Material: Stainless-steel, AISI 304L
- Finish: Scotch-Brite® brushing to guarantee the durability in applications where contact with the floor increases the risk of corrosion
- Installation: It is necessary to order separately the plinth fixing kit (ref. **NSYAPFXWM**) composed by fixing elements and drilling jig

Front and rear plinths



NSYSFPX6100

Supply:
4 corners, 2 panels (front and rear),
4 corner covers and fixing elements

Characteristics	Height mm (in.)	Width mm (in.)	References
Front and rear plinths	100 (3.94)	600 (23.62)	NSYSFPX6100

Side plinths



NSYSSPX6100

Supply:
2 side panels,
4 corner covers and fixing elements

Characteristics	Height mm (in.)	Depth mm (in.)	References
Side plinths	100 (3.94)	600 (23.62)	NSYSSPX6100

Front and rear plinths

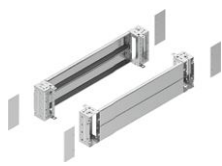

NSYSFPX6200

Supply:
4 corners, 2 panels (front and rear),
4 corner covers and fixing elements

Characteristics	Height mm (in.)	Width mm (in.)	References
Front and rear plinths	200 (7.87)	600 (23.62)	NSYSFPX6200

Side plinths



NSYSSPX6200

Supply:
2 side panels,
4 corner covers and fixing elements

Characteristics	Height mm (in.)	Depth mm (in.)	References
Side plinths	200 (7.87)	600 (23.62)	NSYSSPX6200

HMI encl. Spacial S3CM

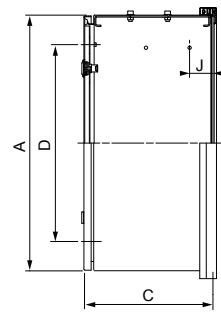
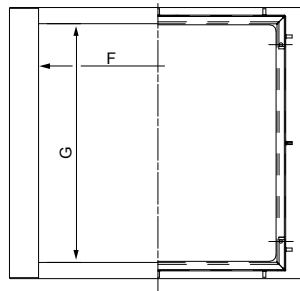

A: Height.
B: Width.
C: Depth.

W600 enclosure + box keyboard installation

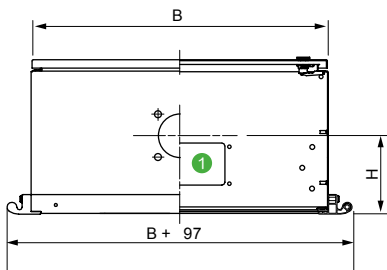

Figure 1
Enclosure depth from
200 (7.87) to 250 (9.84) mm (in.)

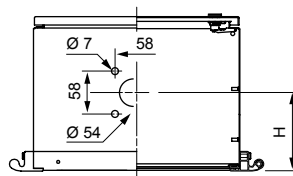
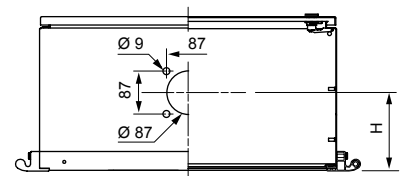

Figure 2
Enclosure depth
300 (11.81) mm (in.)



1 Cable gland plate.

Enclosure dimensions mm (in.)								Cable gland plate	Ø Top hole mm (in.)	Fig.	Enclosure References
Height mm (in.)	Width mm (in.)	Depth mm (in.)	D	F	G	H	J				
300 (11.81)	300 (11.81)	200 (7.87)	162 (6.38)	262 (10.32)	262 (10.32)	100 (3.94)	45 (1.77)	-	54 (2.13)	1	NSYS3CM303020
300 (11.81)	400 (15.75)	200 (7.87)	162 (6.38)	362 (14.25)	262 (10.32)	100 (3.94)	45 (1.77)	-	54 (2.13)	1	NSYS3CM304020
400 (15.75)	400 (15.75)	200 (7.87)	262 (10.32)	362 (14.25)	362 (14.25)	100 (3.94)	45 (1.77)	-	54 (2.13)	1	NSYS3CM404020
400 (15.75)	600 (23.62)	250 (9.84)	262 (10.32)	562 (22.13)	362 (14.25)	125 (4.92)	75 (2.95)	●	54 (2.13)	1	NSYS3CM406025*
500 (19.68)	500 (19.68)	250 (9.84)	362 (14.25)	462 (18.19)	462 (18.19)	125 (4.92)	75 (2.95)	-	54 (2.13)	1	NSYS3CM505025
600 (23.62)	600 (23.62)	200 (7.87)	462 (18.19)	562 (22.13)	562 (22.13)	100 (3.94)	45 (1.77)	●	54 (2.13)	1	NSYS3CM606020*
600 (23.62)	800 (31.50)	300 (11.81)	462 (18.19)	762 (30.00)	562 (22.13)	150 (5.91)	100 (3.94)	-	87 (3.42)	2	NSYS3CM608030
800 (31.50)	600 (23.62)	300 (11.81)	662 (26.06)	562 (22.13)	762 (30.00)	150 (5.91)	100 (3.94)	●	87 (3.42)	2	NSYS3CM806030*

* Enclosure equipped with a cable gland plate.



Perforated rails installed on lateral studs.



Detail of the reinforcement plate.



Rear door with double-bar lock.



Fixing of the trim frame by screws.

Box keyboard for control enclosure

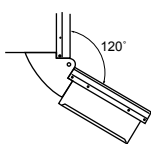
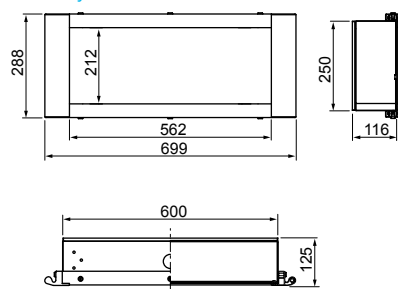

Detail from the installation of the box keyboard on the control enclosure.

Support



Laptop computer

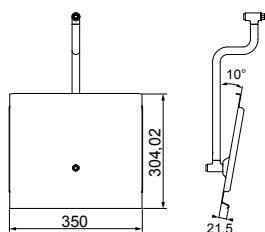

Keyboard

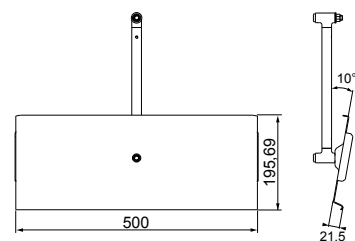

Suspension system

Dimensions mm (in.) ∅ A	50 (1.97) mm (in.) square	80 (3.15) mm (in.) square	50 (1.97) mm (in.) square	80 (3.15) mm (in.) square	50 (1.97) mm (in.) square	80 (3.15) mm (in.) square	50 (1.97) mm (in.) square	80 (3.15) mm (in.) square
B	42 (1.65)	72 (2.84)	92 (3.62)	115 (4.53)	50 (1.97)	74 (2.91)	42 (1.65)	72 (2.84)
C	105 (4.13)	134 (5.28)	118 (4.65)	160 (6.30)	68 (2.68)	98 (3.86)	236 (9.29)	320 (12.60)
D	11 (0.43)	11 (0.43)	42 (1.65)	72 (2.84)	42 (1.65)	72 (2.84)	67 (2.64)	94 (3.70)
E	125 (4.92)	173 (6.81)	85 (3.35)	130 (5.12)	30 (1.18)	45 (1.77)	148 (5.83)	190 (7.48)
F	152 (5.98)	201 (7.91)	11 (0.43)	11 (0.43)	96 (3.78)	144 (5.67)	-	-
G	-	-	148 (5.83)	190 (7.48)	96 (3.78)	141.5 (5.57)	-	-
H	72 (2.84)	111 (4.37)	80 (3.15)	115 (4.53)	134 (5.28)	195.5 (7.70)	-	-
I	97 (3.82)	126 (4.96)	130 (5.12)	175 (6.89)	140 (5.51)	210 (8.27)	-	-
J	-	-	55 (2.16)	90 (3.54)	120 (4.72)	180 (7.09)	-	-
K	-	-	68 (2.68)	103 (4.06)	9 (0.35)	13 (0.51)	-	-
L	110 (4.33)	140 (5.51)	105 (4.13)	150 (5.91)	55 (2.16)	84 (3.31)	-	-
S	15 (0.59)	16 (0.63)	-	-	-	-	-	-

Fixed base

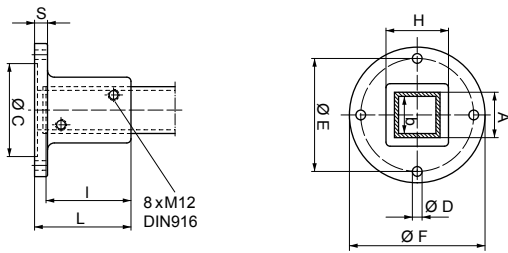

Wall fixing with joint

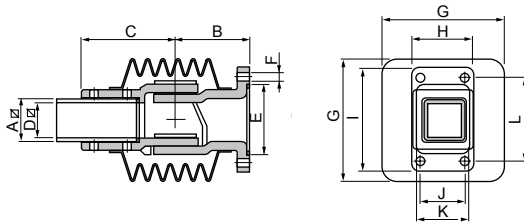

Rotating straight fitting

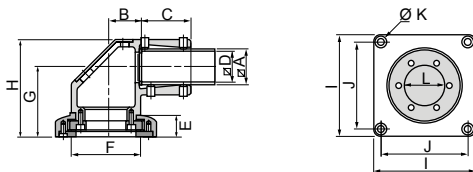

Horizontal inter-tube joint

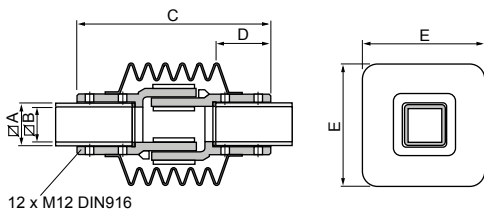

Suspension system

Dimensions mm (in.)	50 (1.97) mm (in.) square	80 (3.15) mm (in.) square	50 (1.97) mm (in.) square	80 (3.15) mm (in.) square	50 (1.97) mm (in.) square	80 (3.15) mm (in.) square	50 (1.97) mm (in.) square	80 (3.15) mm (in.) square
B	46 (1.81)	56 (2.20)	42 (1.65)	72 (2.84)	46 (1.81)	56 (2.20)	55 (2.16)	55 (2.16)
C	60 (2.36)	83 (3.27)	115 (4.53)	145 (5.71)	60 (2.36)	83 (3.27)	100 (3.94)	100 (3.94)
D	60 (2.36)	83 (3.27)	96 (3.78)	139 (5.47)	147 (5.79)	190 (7.48)	44 (1.73)	44 (1.73)
E	46 (1.81)	56 (2.20)	52.3 (2.06)	85 (3.35)	96 (3.78)	139 (5.47)	121 (4.76)	121 (4.76)
F	42 (1.65)	70 (2.76)	58 (2.28)	87 (3.42)	42 (1.65)	72 (2.84)	182 (7.16)	182 (7.16)
G	144 (5.67)	193 (7.60)	-	-	154 (6.06)	208.5 (8.21)	50 (1.97)	50 (1.97)
H	-	-	-	-	42 (1.65)	70 (2.76)	100 (3.94)	100 (3.94)
I	-	-	-	-	58 (2.28)	87 (3.42)	50 (1.97)	50 (1.97)
M	-	-	M6	M8	M6	M8	-	-

Fixed bracket

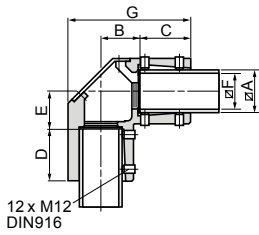

Rotating fixing on enclosure

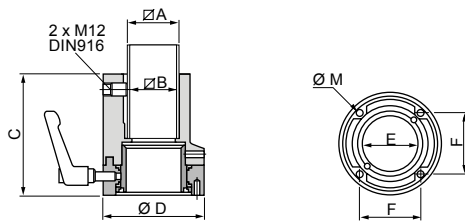

Rotating fixing in bracket on enclosure

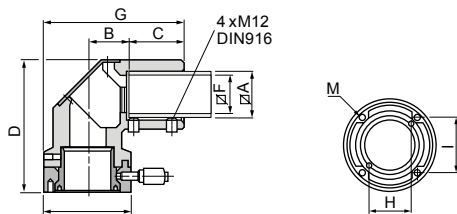

Tilting fixing on enclosure

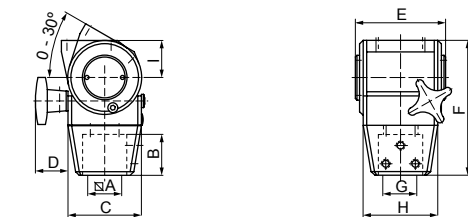

Adapter for signalling beacon

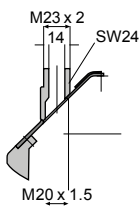

Compact control desk

1 door

2 doors

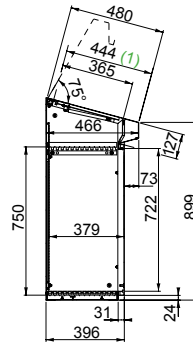
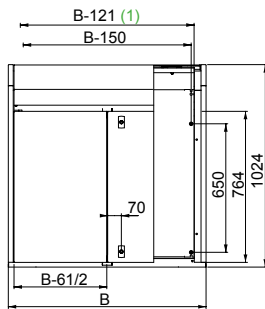
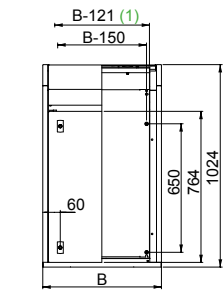

Cable gland plate clearance dimensions mm (in.)	
Width	Maximum opening.
B- 280 (11.02)	56 (2.20)

Common side view.
(1) Usable clearance.

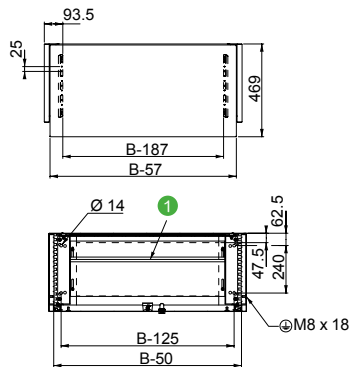
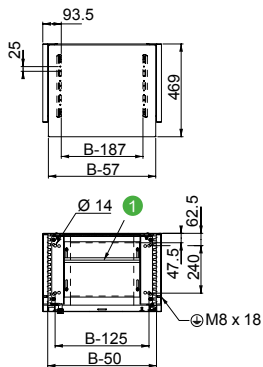

Compact control desks with rear panel

1 door

2 doors

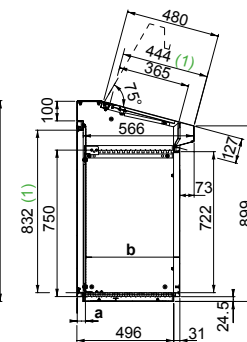
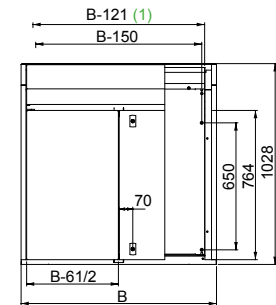
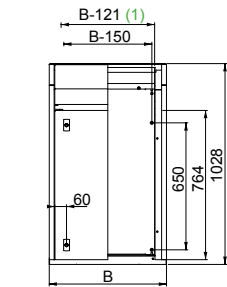

Cable gland plate clearance dimensions mm (in.)	
Width	Maximum opening.
B- 280 (11.02)	56 (2.20)

Adjustment of the depth of the mounting plate mm (in.)

Depth	Min.	Max.
a	42 (1.65)	392 (15.43)
b	129 (5.08)	479 (18.86)

Common side view.
(1) Usable clearance.

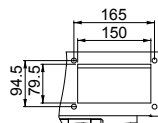
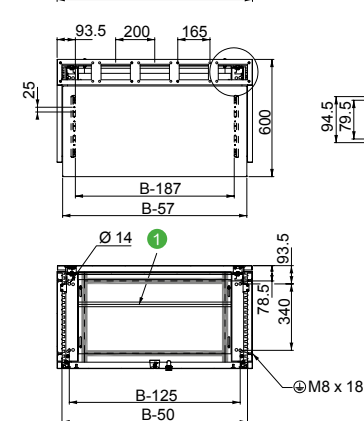
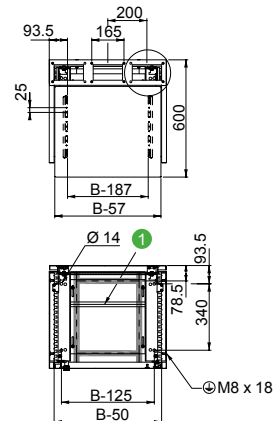

SDX Compact control desks with rear panel

1 door

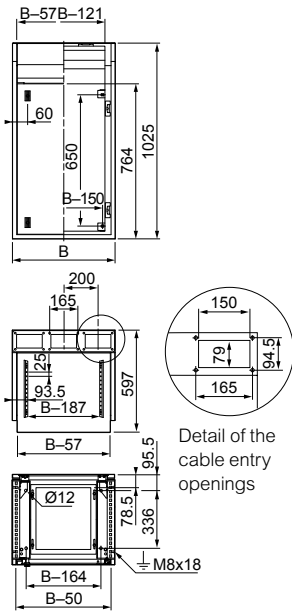

2 doors

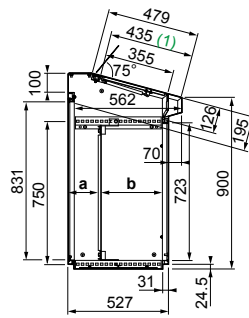
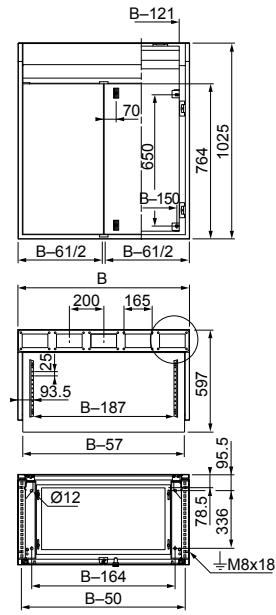

Cable gland plate clearance dimensions mm (in.)

Width	Maximum opening.
B- 280 (11.02)	370 (14.57)

Adjustment of the depth of the mounting plate mm (in.)

Depth	Min.	Max.
a	45 (1.77)	395 (15.55)
b	126 (4.96)	476 (18.74)

Common side view.
(1) Usable clearance.

SD Control desk with console

1 door

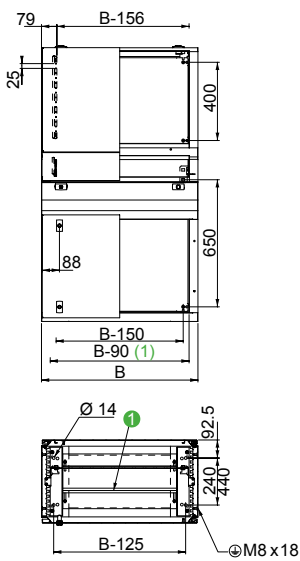

2 doors

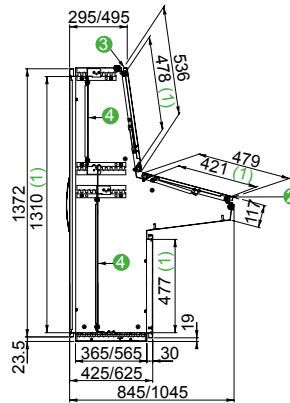
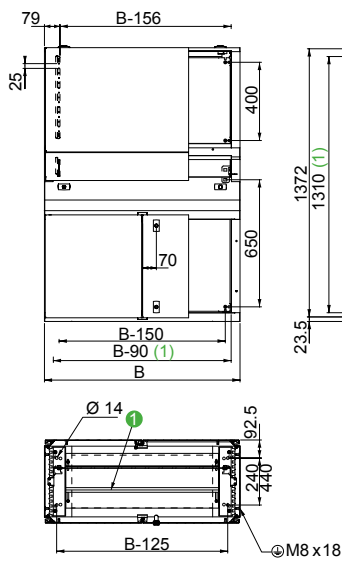

Cable gland plate clearance dimensions mm (in.)

Width	Maximum opening.
B- 280 (11.02)	56 (2.20)

Notes

- 1 1 entry cable gland plate
- 2 Maximum opening of the hinged desk lid: 75°
- 3 Maximum opening of the hinged console cover: 75°
- 4 Optional mounting plate installation, see page 415

Common side view.
(1) Usable clearance.

SD SDX Modular console

Depth 200 (7.87) mm (in.)

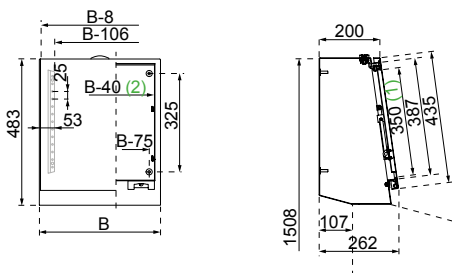

Depth 300 (11.81) mm (in.)

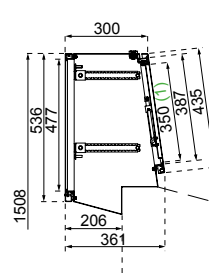

(1) Usable clearance.
(2) Same dimensions for the rear panel.

Spacial SF PC rack

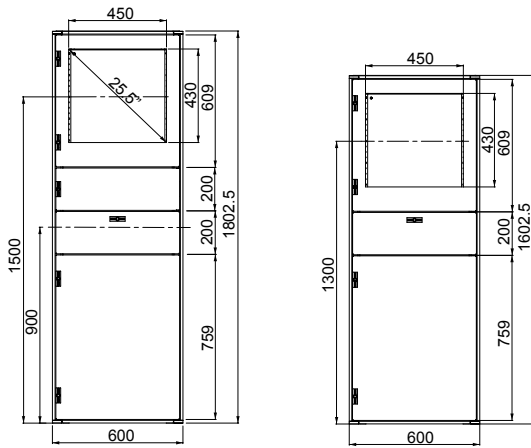

PC rack with a height of 1800 (70.87) mm (in.).

PC rack with a height of 1600 (62.99) mm (in.).

304L stainless-steel PC racks

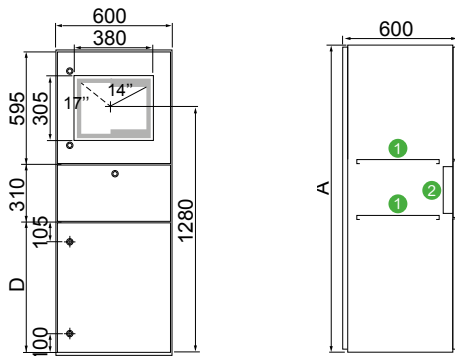

- (1) Screwed shelf, adjustable height.
- (2) Sealed case for keyboard.

A mm (in.)	D mm (in.)
1600 (62.99)	690 (27.16)
1800 (70.87)	890 (35.04)

The variable-speed drives flush-mounting kits have been designed to isolate the power part, which is an important source of heat. They are mounted in the Spacial range of steel enclosures (floor-standing and wall-mounted enclosures) and have been approved for Altivar Process variable-speed drives of the ATV630 and ATV930 ranges (power range: 0.75 to 45 kW at 200/240 V, 0.75 to 90 kW at 380/480 V).

The kits are available in five sizes and offer two methods of mounting variable-speed drives:

- slide-rail mounting for sizes 1, 2 and 3
- bracket mounting for sizes 4 and 5.

The kits can be installed:

- at the back of the enclosure.
This installation provides full thermal insulation.
- inside the enclosure on a mounting plate.
This installation may require additional thermal control.



Tightness

- IP55 according to IEC 60529 with polyurethane seal provided.

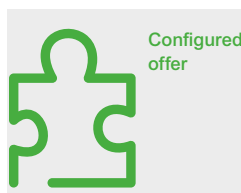

Services

Possibility of cut-outs (enclosure and frame) by Schneider Electric: No risk of corrosion and cuts (cut-out made before painting).



Ease of installation

- Set of slide-rails allowing the variable-speed drive to be mounted quickly and efficiently.



Strength

- The rigidity of the kit allows it to be installed on Spacial S3D, SF and SM enclosures.

Earth continuity

- Earth continuity is ensured by tightening the M6 nuts combined with pin washers.



Maintenance of the variable-speed drive fan (kit sizes 4 and 5)

- Easy front panel maintenance for fan servicing.



Sizes 1, 2 and 3

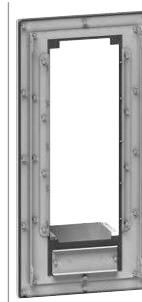

Sizes 4 and 5

Note:
For dimensions see [page 434](#)

Characteristics	Mounting kits
	Variable-speed drive installation kits allowing the hot part to be isolated.
Material	Steel
Finish	Structured finish, epoxy polyester powder
Color	RAL 7035 grey
Ingress protection rating according to IEC 60529	IP55
Certifications	UL 508A types 1, 3R and 12

Supply	<p>Sizes 1, 2 and 3:</p> <ul style="list-style-type: none"> Painted steel plate with cut-out fitted with two slide-rails + adhesive seal + 7 to 9 M6 studs for kit mounting Protection seal profile supplied for frame cut-out Enclosure drilling template 	<p>Sizes 4 and 5:</p> <ul style="list-style-type: none"> Painted steel plates with cut-out fitted with painted mounting brackets + screws and nuts for fixing the brackets and the kit Protection seal supplied for frame cut-out
--------	--	--

Dimensions mm (in.)			Compatibilities							
			Sizes	Enclosures	Variable-speed drives				Kits	
H	L	P			ATV340 380/480 V References	ATV630 200/240 V References	380/480 V References	ATV930 200/240 V References		380/480 V References
360 (14.17)	235 (9.25)	22 (0.87)	1	S3D, SF, SM	-	ATV630U07M3	ATV630U07N4	ATV930U07M3	ATV930U07N4	NSYPTDS1
360 (14.17)	235 (9.25)	22 (0.87)	1	S3D, SF, SM	-	ATV630U15M3	ATV630U15N4	ATV930U15M3	ATV930U15N4	-
360 (14.17)	235 (9.25)	22 (0.87)	1	S3D, SF, SM	-	ATV630U22M3	ATV630U22N4	ATV930U22M3	ATV930U22N4	-
360 (14.17)	235 (9.25)	22 (0.87)	1	S3D, SF, SM	-	ATV630U30M3	ATV630U30N4	ATV930U30M3	ATV930U30N4	-
360 (14.17)	235 (9.25)	22 (0.87)	1	S3D, SF, SM	-	ATV630U40M3	ATV630U40N4	ATV930U40M3	ATV930U40N4	-
360 (14.17)	235 (9.25)	22 (0.87)	1	S3D, SF, SM	-	-	ATV630U55N4	-	ATV930U55N4	-
420 (16.54)	265 (10.43)	22 (0.87)	2	S3D, SF, SM	-	ATV630U55M3	ATV630U75N4	ATV930U55M3	ATV930U75N4	NSYPTDS2
420 (16.54)	265 (10.43)	22 (0.87)	2	S3D, SF, SM	-	-	ATV630D11N4	-	ATV930D11N4	-
555 (21.85)	295 (11.61)	22 (0.87)	3	S3D, SF, SM	-	ATV630U75M3	ATV630D15N4	ATV930U75M3	ATV930D15N4	NSYPTDS3
555 (21.85)	295 (11.61)	22 (0.87)	3	S3D, SF, SM	-	ATV630D11M3	ATV630D18N4	ATV930D11M3	ATV930D18N4	-
555 (21.85)	295 (11.61)	22 (0.87)	3	S3D, SF, SM	-	-	ATV630D22N4	-	ATV930D22N4	-
800 (31.50)	385 (15.16)	151.5 (5.96)	4	SF, SM	ATV340D30N4E	ATV630D15M3	ATV630D30N4	ATV930D15M3	ATV930D30N4	NSYPTDS4
800 (31.50)	385 (15.16)	151.5 (5.96)	4	SF, SM	ATV340D37N4E	ATV630D18M3	ATV630D37N4	ATV930D18M3	ATV930D37N4	-
800 (31.50)	385 (15.16)	151.5 (5.96)	4	SF, SM	-	ATV630D22M3	ATV630D45N4	ATV930D22M3	ATV930D45N4	-
975 (38.39)	427 (16.81)	205.5 (8.09)	5	SF, SM	ATV340D45N4E	ATV630D30M3	ATV630D55N4	ATV930D30M3	ATV930D55N4	NSYPTDS5
975 (38.39)	427 (16.81)	205.5 (8.09)	5	SF, SM	ATV340D55N4E	ATV630D37M3	ATV630D75N4	ATV930D37M3	ATV930D75N4	-
975 (38.39)	427 (16.81)	205.5 (8.09)	5	SF, SM	ATV340D75N4E	ATV630D45M3	ATV630D90N4	ATV930D45M3	ATV930D90N4	-

Variable Speed Drive Flush-Mounting Kits Spacial S3D, SF and SM Dimensions

NSYPTDS1

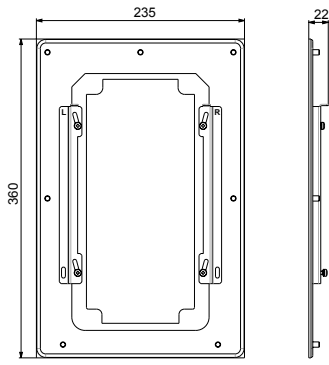

NSYPTDS2

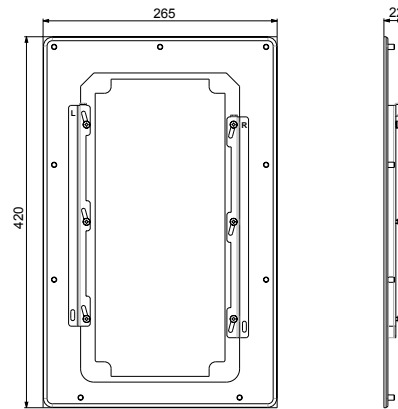

NSYPTDS3

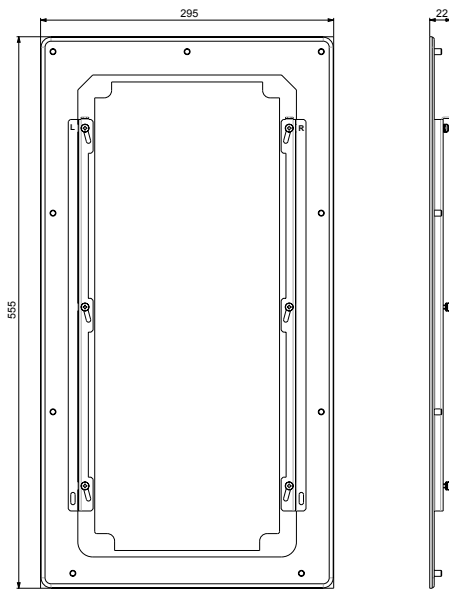

NSYPTDS4

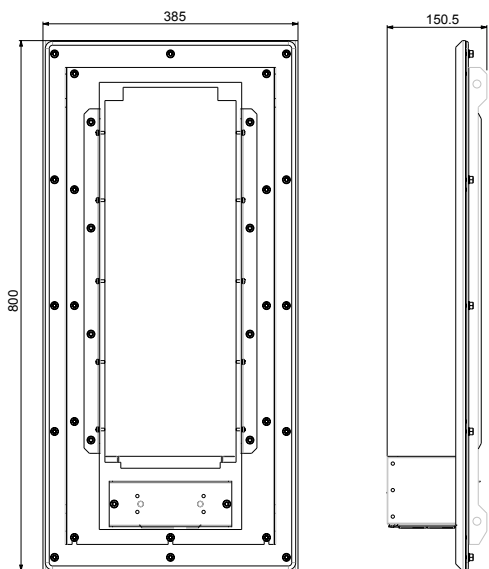

NSYPTDS5

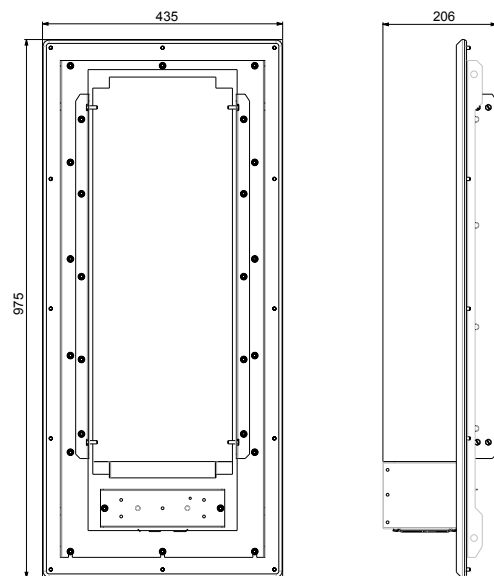

11

Technical changes reserved. Information provided without guarantee. Images are for illustrative purposes only.

The door of the "incoming" enclosure is interlocked by the control of the main switch or circuit breaker. A built-in interlocking system with runner rods prevents the opening of the "outgoing" enclosure doors. Access is only allowed when the main switch or circuit breaker is in "O" position and the main door is open. Manual activation of the rods unlocks the other doors and allows access.

Designed to be combined with specific circuit breakers or switches:

- Square D (9422 A1).
- Schneider Electric.

The system is limited for configurations up to 4 columns.

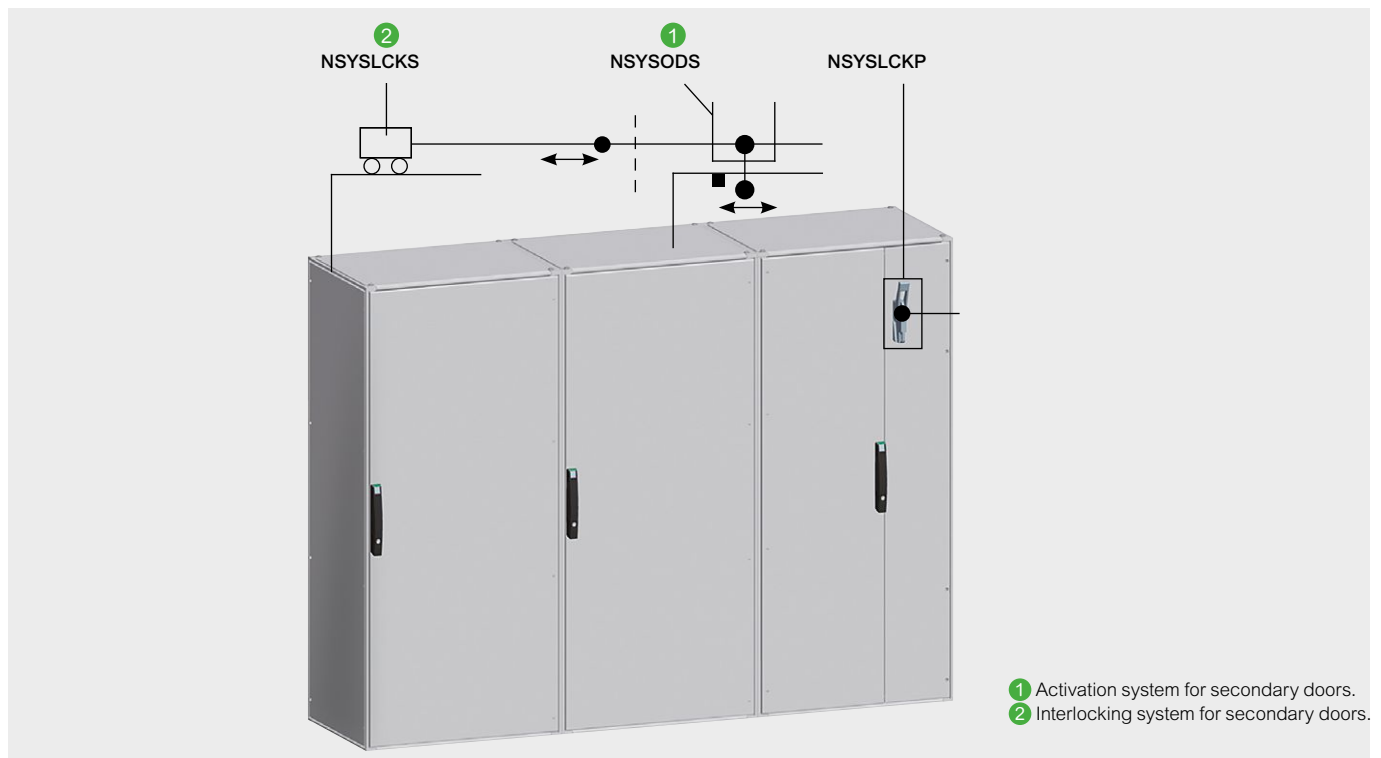

Safety

- The built-in safety interlocking system for the door (on demand) of the incoming/outgoing enclosures allows Spacial SF enclosures to be adapted to the requirements of the American automotive industry.

Interlocking system for main door

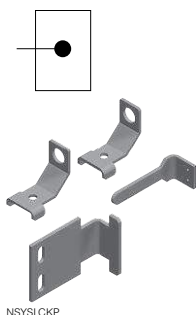

NSYSLCKP

System for unlocking the main door adapted to the switches:

- Allen Bradley (1494 VH11).
- Square D (9422 A1).
- Siemens (FH0H).
- Schneider Electric.

Unlocks the main door when the switch is in the open position "O".

The main door interlocking system requires ordering both references:

- 1 Activation system for secondary doors.
- 2 Interlocking system for secondary doors.

- Material: Steel
- Finish: Zinc-coated

Note:

The fixed panel in this example must be ordered through our customized service.

Supply:

2 brackets for fixing the configured panel, interlocking elements, switch and fixings. Configured panel and switch not included.

Characteristics	References
Interlocking system for main door	NSYSLCKP

Activation system for secondary doors

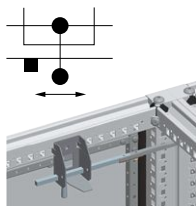

NSYSODS

- System installed in the main enclosure.
- Activated by manual operation, preventing the opening of the secondary enclosures connected to one another by runner rods.
- Safety function consisting of a part that forces the system into the position in which the secondary enclosures are locked in order to lock the main door.
- Material: Mechanism: Zinc-coated steel, Activation handle: Black plastic

Supply:

Elements for activating the main door and fixings.

For the complete function, both activation

- 1 and interlocking systems
- 2 need to be ordered.

Characteristics	References
Activation system for secondary doors	NSYSODS

Interlocking system for secondary doors

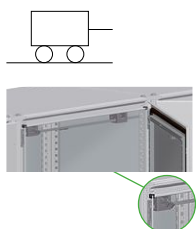

NSYSLCKS6

- System for interlocking the outgoing enclosures connected to one another by runner rods that lock their doors.
- Material: Steel
- Finish: Zinc-coated
- Fixing: Fixing to the structure of the enclosures by screws

Supply:

Elements for interlocking the secondary doors and fixings.

For the complete function, both activation

- 1 and interlocking systems
- 2 need to be ordered according to the enclosure Larg..

Characteristics	Width mm (in.)	References
Interlocking system for secondary doors	600 (23.62)	NSYSLCKS6
Interlocking system for secondary doors	800 (31.50)	NSYSLCKS8
Interlocking system for secondary doors	1000 (39.37)	NSYSLCKS10

ClimaSys Thermal Management System

Thermal management system



Introduction

Presentation	440
ClimaSys CV Airing Systems	446
ClimaSys CA Natural Airing	460
ClimaSys CE Exchangers	462
ClimaSys CU Cooling Units	472
ClimaSys CRS Ultra-thin Resistance Heaters	490
ClimaSys CR Resistance Heaters	492
ClimaSys CC Thermal Control	496
ClimaSys DT Dataloggers	500
How to determine a thermal management solution	502

Thermal problems in enclosures

Evolution of the electrical switchboard

An electrical switchboard is an assembly formed of the following components:

- The enclosure;
- Switchgear and controlgear;
- Electrical conductors; and
- Miscellaneous functions (displays, controls, information processing).

It has evolved in three directions:

- Enclosures increasingly made of insulated materials;
- Switchgear and controlgear incorporating more and more electronics which concentrates a growing number of functions in an increasingly small volume;
- An increasingly high filling rate.



Industrial safety studies, a concept which covers:

- The safety of personnel and equipment;
- The availability of electric power;

These two aspects are the critical point of all industrial and service-sector activities.

Operation must therefore be perfectly under control; and this control must concern not only the operation of the components but also their operating conditions in a given environment.

Temperature and humidity in the enclosure

Analysis of the malfunctions and downtimes of an electrical installation shows that they are mostly of thermal origin: Temperature too high or too low inside the enclosure.

The rise of the average temperature above the limits tolerated by the equipment is often caused by changes to the electrical switchboard:

- Use of insulated materials for the enclosure impairing heat dissipation,
- An increasing number of electronic devices and a higher filling rate increase the temperature.

Such overheating may only occur at certain points of the installation called 'hot spots'.

Excessively low temperatures occur when the electrical switchboard is installed in a very cold environment. This can cause the formation of condensate which is harmful to the equipment.

Consequences

The presence of humidity or excessively high temperatures inside the enclosure can cause numerous malfunctions:

- Nuisance tripping of protective devices;
- Fire inside the enclosure;
- Burns for the users;
- Premature equipment ageing;

These malfunctions lead to an increase in the installation's operating costs:

- Maintenance costs,
- Costs entailed by installation downtimes.

Solution: Thermal management

Objective

The thermal management solution adopted shall:

- Maintain the temperature and humidity level inside the enclosure at values corresponding to normal operation of the equipment.
- Establish a uniform temperature to prevent hot spots.

Choice of solution

The products constituting the thermal management solution are selected to obtain a thermal balance of the installation. This comprises 2 parts:

- Thermal balance inside the enclosure;
- Evaluation of the climatic conditions (temperature, humidity level) or environmental conditions (pollution) of the location of the electrical switchboard.

The Schneider Electric solutions

With the ClimaSys range, Schneider Electric proposes a comprehensive offer meeting all needs:

- Airing
- Cooling
- Heating
- Regulating
- Homogenizing (air circulation)

Schneider Electric also proposes a thermal design software program, ProClima, which produces the thermal balance and proposes one or more thermal management solutions.

Characteristics	Climasys
Cooling	 <p>Forced airing systems Air-to-air exchangers Air-to-water exchangers Cooling units</p>
Heating	 <p>Resistance heaters</p>
Controlling	 <p>Thermal control accessories</p>
Thermal Data	 <p>ProClima software</p>

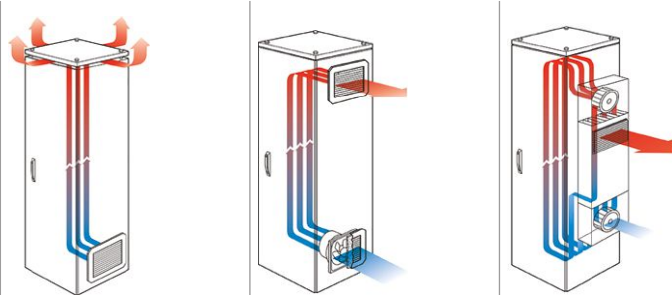

	Homogenize	Cooling	Cooling	Cooling
Solution	Air circulation	Natural airing	Forced airing	Air-to-air exchanger
Description	Circulation fan inside the enclosure	Air circulation achieved by installing grids (side or roof-mounted) with or without filter, or by elevating the roof.	A fan (with or without filter) feeds fresh external air into the enclosure. This creates a slight overpressure, forcing the warm air out of the enclosure through an outlet grid. The air flow balances the temperature, and the overpressure prevents dust ingress. Side or roof-mounted. Can be combined with a thermostat.	Cooling system comprising an aluminum heat exchanger and separate internal and external air circuits and two centrifugal fans circulating the air, and a thermostat for temperature control. Side or roof-mounted.
Use	To prevent hot spots	Low power to be dissipated. Dusty environment	High heat dissipation performance, suitable for dusty and non-hazardous environments. Prevents hot spots.	Medium heat dissipation performance, suitable for corrosive environments (food processing) and relatively cold environments (about 25°C (77°F)).
Temperature conditions Ta = ambient temperature (outside the enclosure) Td = desired temperature inside the enclosure	None	$T_d > T_a + 5^\circ\text{C} (41^\circ\text{F})$	$T_d > T_a + 5^\circ\text{C} (41^\circ\text{F})$ $3^\circ\text{C} (37^\circ\text{F}) < T_a \leq 35^\circ\text{C} (95^\circ\text{F})$	$T_d > T_a + 10^\circ\text{C} (50^\circ\text{F})$
Independent internal and external air circuits?	No	No	No	Yes
Advantages	<ul style="list-style-type: none"> Uniform temperature inside the enclosure 	<ul style="list-style-type: none"> Very economical solution No maintenance Easy, fast installation. 	<ul style="list-style-type: none"> Economical solution Easy maintenance Easy, fast installation Uniform temperature inside the enclosure Guaranteed level of protection: IP54 (IP55 with cover) 	<ul style="list-style-type: none"> Easy maintenance (no filter) Far lower maintenance frequency than for fans IP55 guaranteed between the enclosure and the air-to-air exchanger.
Disadvantages		<ul style="list-style-type: none"> Low power dissipated Reduction of IP rating Risk of ingress of particles and dust if no filter. 	<ul style="list-style-type: none"> Internal temperature always higher than external temperature Maintenance required: filter change 	<ul style="list-style-type: none"> Internal temperature always higher than external temperature.
Illustration				
		Outlet grids	Fans	Air-to-air exchangers

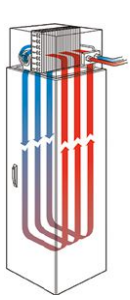

Cooling
Air-to-water exchanger

Cooling system using an exchanger coil supplied with cold water, separated from the internal air circuit, a centrifugal fan for air circulation, and a thermostat to regulate the temperature inside the enclosure. Side-mounted.

Dissipation of large quantities of heat. Suitable for difficult environments (cement plants, production lines, etc.) or humid environments (sewage plants, bottling lines, etc.). Calorific energy is not discharged to the environment.

$T_a > T_d$

Yes

- Internal temperature independent of external temperature
- Protection system against any leaks
- Calorific energy dissipated externally.
- Guaranteed level of protection: IP55.

- Cold-water circuit with stabilized temperature and flow rate required
- Installation of special piping.



Air-to-water exchangers

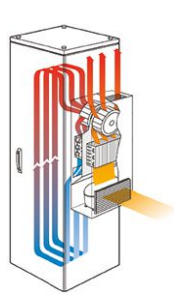

Cooling
Cooling unit

Operates like a heat pump: A condenser dissipates the calorific energy absorbed by an evaporator to the ambient air, thereby cooling and drying the air in the enclosure. Mounted on sides, floor, roof and floor-standing.

Highly polluted environment permitting the use of a filter for external protection of the cooling unit.

$T_a > T_d$ and $T_a \leq 55^\circ\text{C}$ (131°F)

Yes

- Internal temperature independent of external temperature
- Even temperature inside the enclosure.
- Guaranteed level of protection: IP54 for roof and big cooling models, IP55 for side-mounted models and the SLIM range
- Use of an ecological gas
- Drainage system for condensed water from evaporator

- Water condensation evaporation unit integrated in side-mounted models from 0.6 kW to 4 kW
- Maintenance required: filter change



Cooling units

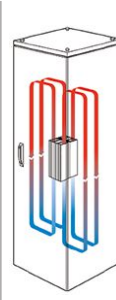

Heating
Resistor heaters

The heating resistors help prevent the formation of condensation and help ensure an ideal temperature inside the enclosure.

To heat the inside of the enclosure and prevent condensation.

$T_a < T_d$

-

- Small size (1.6 (0.06) mm (in.) thick for the ultra-thin version)
- Low surface temperature (< 70°C (158°F) for insulated version, 75°C (167°F) for aluminum version)
- Even temperature inside the enclosure with the version equipped with a fan.



Heating resistors

Large range of fans: flow rate efficiency, high protection rating, quick installation and easier maintenance to secure all the applications.

Airing systems

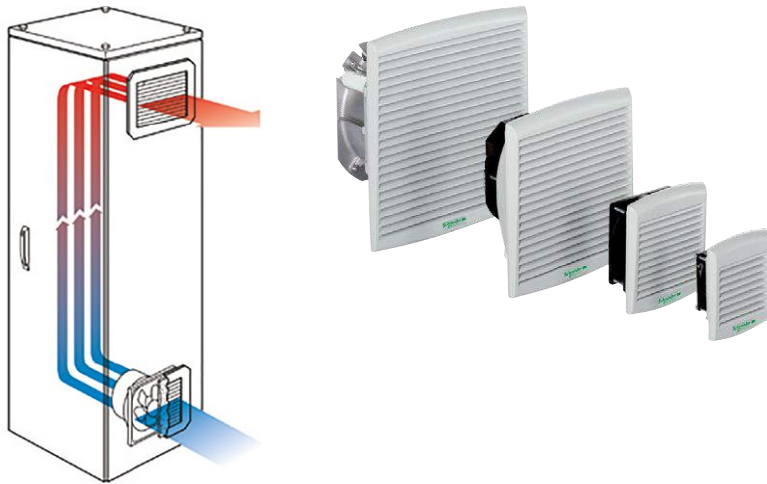

Easy maintenance

Quick filter replacement

- Quick, easy and safe replacement of the filter installed in the fan, even during operation.



Certifications

- UL



Quality of components

Selection of motors

- Improved flow rate and longer service life.
- Large range of input voltages available on all motors delivered as standard, with 50/60-Hz alternating current or direct current

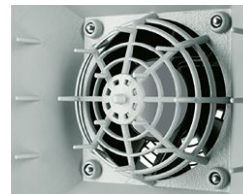

Optimized flow rate: average increase of 50%

- Maximum use of surface.
- Minimal loss of pressure.



Easy installation

Quick installation

- Safe, reliable fixing with the assisted fixing device and the system of multi-thickness fixing-clips.
- Easy to invert.
- To operate as extractors, all the motors can be inverted by simply removing four screws.

High protection rating: IP54 as standard

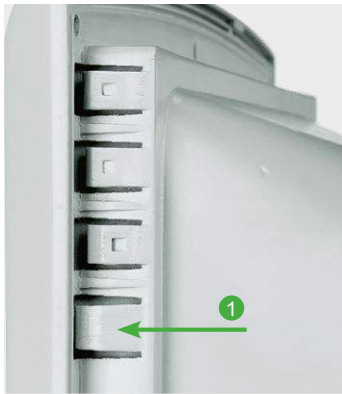

1 Fixing guide

- To center the body of the fan on the wall of enclosure.
- To correct machining faults.
- To facilitate the correct operation of the fixing "clips".

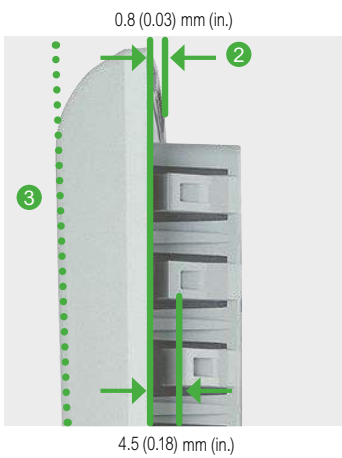

2 Multi-thickness fixing-clips

- To help guarantee easy and reliable fixing of the airing system.
- With a thickness of 0.8 (0.03) to 4.5 (0.18) mm (in.), with no fixings.

3 Inclined profile of the grille

- To protect the filter against vertical spraying: each slat is protected by the slat above it, with the external dimensions remaining small.

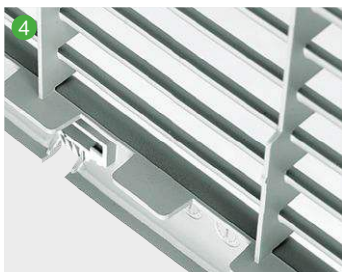

4 IP54 (IP55 with the cover)

- A patented system allows the evacuation of water absorbed by the filter,
- In particular during high-pressure spraying.



5 Hot-fitted sealing gasket

- The polyurethane gasket, hot cast, helps guarantee a long-lasting seal.



6 Effective filter-retaining system

- The system for holding the synthetic filter in the cavity of the filter holder ensures a protection rating of IP54, even under the most difficult conditions.

- Characteristics: The fans comprise an axial motor, a protective housing on the front and rear surfaces and a filter designed to retain dust particles. This filter can be replaced during operation without risk of contact with the rotating element.
- Material of external grids: Injected thermoplastic (ASA PC). self-extinguishing according to UL 94 V-0
- Color external grids: RAL 7035 grey as standard
- Conditions of use: The external temperature must not exceed 30°C (86°F) and must be more than 5°C (41°F) lower than the temperature wanted in the enclosure. The filters that equip the fans must be cleaned and replaced regularly. The ambient air must be relatively clean and overfrequent filter replacement should be avoided. Bear in mind the pressure losses caused by the outlet element (grille with filter, airing louver or simple opening) when determining the fan flow rate
- Storage Temperature: -40°C (-40°F)... 70°C (158°F)
- Ingress protection rating (according to IEC 60529): IP54
- If the enclosure contains electronics, material sensitive to dust deposits or if it is needed to use several fans and grills in the same enclosure, we highly recommend using PROCLIMA and a solution with better filtering using a G3 filter or a higher IP (cooling option as example). In any case, do not hesitate to contact our sales teams to collaborate on your project.
- Mechanical protection rating (according to IEC 62262): IK08
- Installation: The cut-out template supplied with the device avoids the need for marking and helps protect the surface of the enclosure during handling
- All fan references with free air flow rate above 38m³/h (NSYCVF85MxxxPF, NSYCVF165MxxxPF, NSYCVF300MxxxPF, NSYCVF560MxxxPF, NSYCVF850MxxxPF) are also delivered with one anti-insect filter
- Options: The device can be equipped with a filter that provides even more efficient protection for your sensitive facilities against dust particles

Free flow rate with standard filter m ³ /h (ft ³ /min)	Flow rate with outlet grille(s) m ³ /h (ft ³ /min)		Voltage range (nominal voltage)	Absorbed power (max. intensity)	Noise level	External dimensions (cut-out)	Weight kg (lbs.)	Operating temperature	Max. static pressure
	1	2							
38 (22.37) (50 Hz)	25 (14.71) (50 Hz)	33 (19.42) (50 Hz)	150 V...250 V (230 V)	4.5/4.8 W (0.16/0.17 A)	40/41 dB (A)	137 (5.39) x 117 (4.61) x 49 (1.93) (92 (3.62) x 92 (3.62))	0.220 (0.49)	-10°C (14°F) ...+ 70°C (158°F)	29 Pa
39 (22.96) (60 Hz)	26 (15.30) (60 Hz)								
38 (22.37) (50 Hz)	27 (15.89) (50 Hz)	35 (20.60) (50 Hz)	75 V...125 V (115 V)	3.3/3.5 W (0.16/0.16 A)	40/41 dB (A)	137 (5.39) x 117 (4.61) x 49 (1.93) (92 (3.62) x 92 (3.62))	0.220 (0.49)	-10°C (14°F) ...+ 70°C (158°F)	29 Pa
39 (22.96) (60 Hz)	28 (16.48) (60 Hz)								
58 (34.14)	39 (22.96)	47 (27.66)	10 V...27.6 V (24 V DC)	3.6 W (0.18 A)	40/41 dB (A)	137 (5.39) x 117 (4.61) x 49 (1.93) (92 (3.62) x 92 (3.62))	0.230 (0.51)	-10°C (14°F) ...+ 70°C (158°F)	29 Pa
44 (25.90)	34 (20.01)	41 (24.13)	36 V...56 V (48 V DC)	3.6 W (70 mA)	40/41 dB (A)	137 (5.39) x 117 (4.61) x 49 (1.93) (92 (3.62) x 92 (3.62))	0.230 (0.51)	-10°C (14°F) ...+ 70°C (158°F)	29 Pa
85 (50.03) (50 Hz)	63 (37.08) (50 Hz)	71 (41.79) (50 Hz)	175 V...253 V (230 V)	17/15 W (0.121/0.097 A)	46/49 dB (A)	170 (6.69) x 150 (5.91) x 62 (2.44) (125 (4.92))	0.780 (1.72)	-20°C (-4°F) ...+ 60°C (140°F)	50 Pa
98 (57.68) (60 Hz)	72 (42.38) (60 Hz)								
79 (46.50) (50 Hz)	65 (38.26) (50 Hz)	73 (42.97) (50 Hz)	75 V...126 V (115 V)	16/15 W (0.207/0.179 A)	46/49 dB (A)	170 (6.69) x 150 (5.91) x 62 (2.44) (125 (4.92))	0.780 (1.72)	-20°C (-4°F) ...+ 60°C (140°F)	50 Pa
92 (54.15) (60 Hz)	74 (43.56) (60 Hz)								
80 (47.09)	57 (33.55)	77 (45.32)	10 V...27.6 V (24 V DC)	7.6 W (0.30 A)	46/49 dB (A)	170 (6.69) x 150 (5.91) x 62 (2.44) (125 (4.92))	0.480 (1.06)	-10°C (14°F) ...+ 70°C (158°F)	50 Pa
79 (46.50)	59 (34.73)	68 (40.02)	25 V...55.2 V (48 V DC)	8 W (0.173 A)	46/49 dB (A)	170 (6.69) x 150 (5.91) x 62 (2.44) (125 (4.92))	0.480 (1.06)	-10°C (14°F) ...+ 70°C (158°F)	50 Pa
165 (97.12) (50 Hz)	153 (90.05) (50 Hz)	161 (94.76) (50 Hz)	175 V...253 V (230 V)	16.3/14.3 W (0.12/0.94 A)	50/51 dB (A)	268 (10.55) x 248 (9.76) x 104 (4.09) (223 (8.78) x 223 (8.78))	1.140 (2.51)	-20°C (-4°F) ...+ 60°C (140°F)	50 Pa
193 (113.60) (60 Hz)	171 (100.65) (60 Hz)	175 (103.00) (60 Hz)							
164 (96.53) (50 Hz)	153 (90.05) (50 Hz)	161 (94.76) (50 Hz)	75 V...126 V (115 V)	15.5/14.4 W (0.20/0.18 A)	50/51 dB (A)	268 (10.55) x 248 (9.76) x 104 (4.09) (223 (8.78) x 223 (8.78))	1.140 (2.51)	-20°C (-4°F) ...+ 60°C (140°F)	50 Pa
193 (113.60) (60 Hz)	171 (100.65) (60 Hz)	179 (105.36) (60 Hz)							
188 (110.65)	171 (100.65)	179 (105.36)	10 V...27.6 V (24 V DC)	8 W (0.3 A)	50/51 dB (A)	268 (10.55) x 248 (9.76) x 104 (4.09) (223 (8.78) x 223 (8.78))	0.810 (1.79)	-10°C (14°F) ...+ 70°C (158°F)	50 Pa
193 (113.60)	171 (100.65)	179 (105.36)	25 V...55.2 V (48 V DC)	8.7 W (0.18 A)	50/51 dB (A)	268 (10.55) x 248 (9.76) x 104 (4.09) (223 (8.78) x 223 (8.78))	0.810 (1.79)	-10°C (14°F) ...+ 70°C (158°F)	50 Pa
302 (177.75) (50 Hz)	260 (153.03) (50 Hz)	268 (157.74) (50 Hz)	145 V...253 V (230 V)	36/37 W (0.177/0.16 A)	55/56 dB (A)	268 (10.55) x 248 (9.76) x 116 (4.57) (223 (8.78) x 223 (8.78))	1.3 (2.87)	-10°C (14°F) ...+ 70°C (158°F)	158 Pa
350 (206.00) (60 Hz)	307 (180.69) (60 Hz)								
302 (177.75) (50 Hz)	263 (154.80) (50 Hz)	271 (159.50) (50 Hz)	75 V...126 V (115 V)	36/36 W (0.35/0.32 A)	55/56 dB (A)	268 (10.55) x 248 (9.76) x 116 (4.57) (223 (8.78) x 223 (8.78))	1.3 (2.87)	-10°C (14°F) ...+ 70°C (158°F)	158 Pa
350 (206.00) (60 Hz)	307 (180.69) (60 Hz)								
262 (154.21)	221 (130.08)	229 (134.78)	12 V...30 V (24 V DC)	13 W (0.53 A)	55/56 dB (A)	268 (10.55) x 248 (9.76) x 103.4 (4.07) (223 (8.78) x 223 (8.78))	1.1 (2.43)	-10°C (14°F) ...+ 70°C (158°F)	158 Pa
247 (145.38)	210 (123.60)	218 (128.31)	25 V...60 V (48 V DC)	11 W (0.24 A)	55/56 dB (A)	268 (10.55) x 248 (9.76) x 103.4 (4.07) (223 (8.78) x 223 (8.78))	1.1 (2.43)	-10°C (14°F) ...+ 70°C (158°F)	158 Pa
562 (330.78) (50 Hz)	473 (278.40) (50 Hz)	481 (283.11) (50 Hz)	207 V...244 V (230 V)	68/85 W (0.52/0.370 A)	59/59 dB (A)	336 (13.23) x 316 (12.44) x 161 (6.34) (291 (11.46) x 291 (11.46))	3.2 (7.05)	-15°C (5°F) ...+ 60°C (140°F)	140 Pa
586 (344.91) (60 Hz)	477 (280.75) (60 Hz)								
582 (342.55) (50 Hz)	485 (285.46) (50 Hz)	494 (290.76) (50 Hz)	103 V...122 V (115 V)	65/83 W (0.60/0.72 A)	59/59 dB (A)	336 (13.23) x 316 (12.44) x 161 (6.34) (291 (11.46) x 291 (11.46))	3.2 (7.05)	-15°C (5°F) ...+ 60°C (140°F)	140 Pa
586 (344.91) (60 Hz)	477 (280.75) (60 Hz)								
838 (493.23) (50 Hz)	718 (422.60) (50 Hz)	728 (428.48) (50 Hz)	207 V...244 V (230 V)	150/195 W (0.65/0.85 A)	76/75 dB (A)	336 (13.23) x 316 (12.44) x 162 (6.38) (291 (11.46) x 291 (11.46))	4.1 (9.04)	-15°C (5°F) ...+ 60°C (140°F)	170 Pa
803 (472.63) (60 Hz)	568 (334.31) (60 Hz)								
983 (578.57) (50 Hz)	843 (496.17) (50 Hz)	854 (502.64) (50 Hz)	103 V...122 V (115 V)	145/182 W (1.279/1.6 A)	78/77 dB (A)	336 (13.23) x 316 (12.44) x 162 (6.38) (291 (11.46) x 291 (11.46))	4.1 (9.04)	-15°C (5°F) ...+ 60°C (140°F)	170 Pa
944 (555.62) (60 Hz)	642 (377.87) (60 Hz)								
931 (547.97) (50 Hz)	798 (469.68) (50 Hz)	809 (476.16) (50 Hz)	396 V...466 V (400 V)	126/126 W (0.226/0.232 A)	77/75 dB (A)	336 (13.23) x 316 (12.44) x 162 (6.38) (291 (11.46) x 291 (11.46))	4.1 (9.04)	-15°C (5°F) ...+ 60°C (140°F)	170 Pa
803 (472.63) (60 Hz)	568 (334.31) (60 Hz)								



Type of connection				
by cable Forced airing fan 38 m³/h	by faston ⁽¹⁾ Forced airing fan 85 m³/h	by faston ⁽¹⁾ Forced airing fan 165 m³/h	by faston ⁽¹⁾ Forced airing fan 300 m³/h	by terminal block Forced airing fan 560-850 m³/h
NSYCVF38M230PF ★	-	-	-	-
NSYCVF38M115PF ★	-	-	-	-
NSYCVF38M24DPF	-	-	-	-
NSYCVF38M48DPF	-	-	-	-
-	NSYCVF85M230PF	-	-	-
-	NSYCVF85M115PF	-	-	-
-	NSYCVF85M24DPF	-	-	-
-	NSYCVF85M48DPF	-	-	-
-	-	NSYCVF165M230PF	-	-
-	-	NSYCVF165M115PF	-	-
-	-	NSYCVF165M24DPF	-	-
-	-	NSYCVF165M48DPF	-	-
-	-	-	NSYCVF300M230PF	-
-	-	-	NSYCVF300M115PF	-
-	-	-	NSYCVF300M24DPF	-
-	-	-	NSYCVF300M48DPF	-
-	-	-	-	NSYCVF560M230PF
-	-	-	-	NSYCVF560M115PF
-	-	-	-	NSYCVF850M230PF
-	-	-	-	NSYCVF850M115PF
-	-	-	-	NSYCVF850M400PF

⁽¹⁾ Fan models with connection are delivered with the connection cord included (2 metres).

 ★ Warning: The fan NSYCVF38M230PF and NSYCVF38M115PF MUST NOT be connected to a power conversion module, an inverter or UPS type of power supply !

Airing Systems, IP54 outlet grilles

- Delivered G2 M1 synthetic standard filter according to ISO 16890 and **NSYCAG125LPF**, **NSYCAG223LPF**, **NSYCAG291LPF** are also delivered with anti-insect filter.
- Material: Injected thermoplastic (ASA PC), self-extinguishing according to UL 94 V-0
- Color: RAL 7035 grey
- Ingress protection rating (according to IEC 60529): IP54
- UL recognized (cURus), rated Type 12 according to UL50E



NSYCAG92LPF

Characteristics	Height mm (in.)	Width mm (in.)	Depth mm (in.)	Cut-out mm (in.)	References
IP54 outlet grilles	137 (5.39)	117 (4.61)	13 (0.51)	92 (3.62) x 92 (3.62)	NSYCAG92LPF
IP54 outlet grilles	170 (6.69)	150 (5.91)	15 (0.59)	125 (4.92) x 125 (4.92)	NSYCAG125LPF
IP54 outlet grilles	268 (10.55)	248 (9.76)	18 (0.71)	223 (8.78) x 223 (8.78)	NSYCAG223LPF
IP54 outlet grilles	336 (13.23)	316 (12.44)	18 (0.71)	291 (11.46) x 291 (11.46)	NSYCAG291LPF

Filters

- For fans and grilles.
- Filters according to ISO 16890.



NSYCAF223T

Characteristics	Height mm (in.)	Width mm (in.)	Cut-out mm (in.)	References
G2 M1 synthetic standard filters	137 (5.39)	117 (4.61)	92 (3.62) x 92 (3.62)	NSYCAF92
G2 M1 synthetic standard filters	170 (6.69)	150 (5.91)	125 (4.92) x 125 (4.92)	NSYCAF125
G2 M1 synthetic standard filters	268 (10.55)	248 (9.76)	223 (8.78) x 223 (8.78)	NSYCAF223
G2 M1 synthetic standard filters	336 (13.23)	316 (12.44)	291 (11.46) x 291 (11.46)	NSYCAF291
Filters for greasy environments G2 M1	170 (6.69)	150 (5.91)	125 (4.92) x 125 (4.92)	NSYCAF125O
Filters for greasy environments G2 M1	268 (10.55)	248 (9.76)	223 (8.78) x 223 (8.78)	NSYCAF223O
Filters for greasy environments G2 M1	336 (13.23)	316 (12.44)	291 (11.46) x 291 (11.46)	NSYCAF291O
G3 M1 synthetic fine filters	170 (6.69)	150 (5.91)	125 (4.92) x 125 (4.92)	NSYCAF125T
G3 M1 synthetic fine filters	268 (10.55)	248 (9.76)	223 (8.78) x 223 (8.78)	NSYCAF223T
G3 M1 synthetic fine filters	336 (13.23)	316 (12.44)	291 (11.46) x 291 (11.46)	NSYCAF291T
Stainless-steel anti-insect filters	137 (5.39)	117 (4.61)	92 (3.62) x 92 (3.62)	NSYCAF92M
Stainless-steel anti-insect filters	170 (6.69)	150 (5.91)	125 (4.92) x 125 (4.92)	NSYCAF125M
Stainless-steel anti-insect filters	268 (10.55)	248 (9.76)	223 (8.78) x 223 (8.78)	NSYCAF223M
Stainless-steel anti-insect filters	336 (13.23)	316 (12.44)	291 (11.46) x 291 (11.46)	NSYCAF291M

Supply:

- G2 M1 synthetic standard filters, Filters for greasy environments G2 M1, G3 M1 synthetic fine filters: 5 units
- Stainless-steel anti-insect filters: 1 unit

Anti-vandalism kit



NSYCAAPV

- Helps prevent the grid from being opened from the outside.
- The unlocking thumbwheel is accessed from the inside of the enclosure.
- Color: RAL 7011

Characteristics	References
Anti-vandalism kit	NSYCAAPV

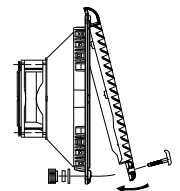

Supply:

2 items per kit

Covers IP55

- This solution protects the fan or grille from any direct spray.
- The cover is the preferred solution to ensure the following:
 - an efficient air flow for cooling,
 - IP55 rating.
- Material: 2 materials available:
 - steel painted with epoxy polyester powder (RAL 7035 grey) for outdoor applications
 - stainless-steel 304L for food and beverage applications
- Ingress protection rating (according to IEC 60529): IP55
- Mechanical protection rating (according to IEC 62262): IK10
- Certifications: UL 508A
- Installation: Double insulation maintained if installed in an insulated enclosure. The cover is placed over the fan or the grille with a filter located at the bottom of the cover to prevent the entry of particles. Easy access to the filter: Only two screws needed. When mounting: Remove the external part of the fan or the grille as well as the filter.

⁽¹⁾ Values given for a fan powered at 230 V. For other voltages, the values are similar

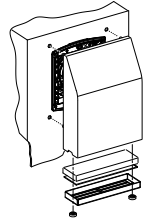

Supply:
It is necessary to order 1 fan + 1 grille + 2 covers to have a complete system



NSYCAP125LZF

Characteristics	Flow rate m ³ /h (ft ³ /min) with cover ⁽¹⁾		Dimensions		References
	Free	With 1 outlet grille	External mm (in.)	Cut-out mm (in.)	
Steel painted RAL 7035 grey	74 (43.56)	53 (31.20)	240 (9.45) x 180 (7.09) x 60 (2.36)	125 (4.92) x 125 (4.92)	NSYCAP125LZF
Steel painted RAL 7035 grey	110 (64.74)	82 (48.26)	350 (13.78) x 305 (12.01) x 80 (3.15)	223 (8.78) x 223 (8.78)	NSYCAP223LZF
Steel painted RAL 7035 grey	165 (97.12)	123 (72.40)	350 (13.78) x 305 (12.01) x 80 (3.15)	223 (8.78) x 223 (8.78)	NSYCAP223LZF
Steel painted RAL 7035 grey	316 (185.99)	265 (155.97)	430 (16.93) x 373 (14.68) x 105 (4.13)	291 (11.46) x 291 (11.46)	NSYCAP291LZF
Steel painted RAL 7035 grey	502 (295.47)	430 (253.09)	430 (16.93) x 373 (14.68) x 105 (4.13)	291 (11.46) x 291 (11.46)	NSYCAP291LZF
Stainless-steel 304L	74 (43.56)	53 (31.20)	240 (9.45) x 180 (7.09) x 60 (2.36)	125 (4.92) x 125 (4.92)	NSYCAP125LXF
Stainless-steel 304L	110 (64.74)	82 (48.26)	350 (13.78) x 305 (12.01) x 80 (3.15)	223 (8.78) x 223 (8.78)	NSYCAP223LXF
Stainless-steel 304L	165 (97.12)	123 (72.40)	350 (13.78) x 305 (12.01) x 80 (3.15)	223 (8.78) x 223 (8.78)	NSYCAP223LXF
Stainless-steel 304L	316 (185.99)	265 (155.97)	430 (16.93) x 373 (14.68) x 105 (4.13)	291 (11.46) x 291 (11.46)	NSYCAP291LXF
Stainless-steel 304L	502 (295.47)	430 (253.09)	430 (16.93) x 373 (14.68) x 105 (4.13)	291 (11.46) x 291 (11.46)	NSYCAP291LXF

Spare filter for cover

Supply:
5 items per kit



NSYCAF125L55

Characteristics	Flow rate m ³ /h (ft ³ /min) with cover ⁽¹⁾		Dimensions		References
	Free	With 1 outlet grille	External mm (in.)	Cut-out mm (in.)	
Spare filter for cover	74 (43.56)	53 (31.20)	240 (9.45) x 180 (7.09) x 60 (2.36)	125 (4.92) x 125 (4.92)	NSYCAF125L55
Spare filter for cover	110 (64.74)	82 (48.26)	350 (13.78) x 305 (12.01) x 80 (3.15)	223 (8.78) x 223 (8.78)	NSYCAF223L55
Spare filter for cover	165 (97.12)	123 (72.40)	350 (13.78) x 305 (12.01) x 80 (3.15)	223 (8.78) x 223 (8.78)	NSYCAF223L55
Spare filter for cover	316 (185.99)	265 (155.97)	430 (16.93) x 373 (14.68) x 105 (4.13)	291 (11.46) x 291 (11.46)	NSYCAF291L55
Spare filter for cover	502 (295.47)	430 (253.09)	430 (16.93) x 373 (14.68) x 105 (4.13)	291 (11.46) x 291 (11.46)	NSYCAF291L55

Characteristics				Fan	Grille
				RAL 7035 grey	RAL 7035 grey
Flow rate m ³ /h (ft ³ /min) with cover ⁽¹⁾		Dimensions mm (in.)		References	References
Free	With 1 outlet grille	External	Cut-out		
74 (43.56)	53 (31.20)	240 (9.45) x 180 (7.09) x 60 (2.36)	125 (4.92) x 125 (4.92)	NSYCVF85M230PF	NSYCAG125LPPF
110 (64.74)	82 (48.26)	350 (13.78) x 305 (12.01) x 80 (3.15)	223 (8.78) x 223 (8.78)	NSYCVF165M230PF	NSYCAG223LPPF
165 (97.12)	123 (72.40)	350 (13.78) x 305 (12.01) x 80 (3.15)	223 (8.78) x 223 (8.78)	NSYCVF300M230PF	NSYCAG223LPPF
316 (185.99)	265 (155.97)	430 (16.93) x 373 (14.68) x 105 (4.13)	291 (11.46) x 291 (11.46)	NSYCVF560M230PF	NSYCAG291LPPF
502 (295.47)	430 (253.09)	430 (16.93) x 373 (14.68) x 105 (4.13)	291 (11.46) x 291 (11.46)	NSYCVF850M230PF	NSYCAG291LPPF

Airing system, heavy-duty

Fanbox



NSYCVF550M24FB

- Free flow rate: 550 m³/h (50/60 Hz).
- Minimal depth inside the enclosure (90 (3.54) mm (in.)).
- Allows multiple cooling architectures (see page 452 and 453).
- Material: Plastic
- Color: RAL 7016 dark grey

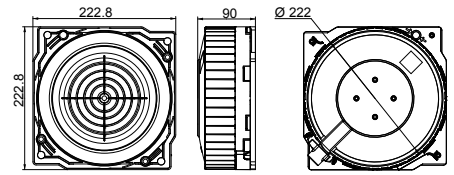

Supply:
1 (grille not included)

Characteristics	Voltage	References
Fanbox	24 V DC	NSYCVF550M24FB
Fanbox	115 V AC	NSYCVF550M115FB
Fanbox	230 V AC	NSYCVF550M230FB

IP55 HD Metal Grille



NSYCAAG223LFHD

- Slim grille (35 (1.38) mm (in.) external depth).
- Includes a G3 M1
- Material: Steel with anti-corrosive painting + plastic PA6 / GF25 for fixing frame
- Finish: Structured finish, 100% polyester powder
- Color: RAL 7035 grey
- Ingress protection rating: IP55 according to IEC 60529
- Mechanical protection rating: IK10 according to IEC 62262

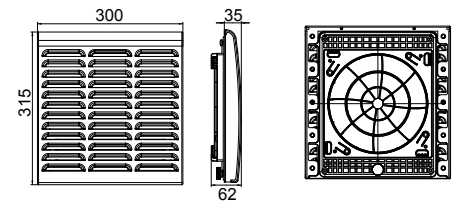

Supply:
1 grille delivered with G3 M1 type synthetic filter (215 (8.46) x 215 (8.46) mm (in.)) and fixings

Characteristics	References
IP55 HD Metal Grille	NSYCAAG223LFHD

Roof filter for fanbox (extraction mode)



NSYCAF190

- Roof G2 round synthetic filter designed to cover the fanbox. Covers completely the fanbox to protect it from dust and humidity. Mandatory for fanbox installation in the roof airing module for IP55 configurations.
- Material: 100% polyester fibers
- Color: White

Supply:
1

Characteristics	References
Roof filter for fanbox	NSYCAF190

Filter



NSYCAF223T

- Replacement G3 M1-type synthetic filter for HD metal grille.
- Dimensions: 215 (8.46) x 215 (8.46) mm (in.).
- Material: 100% polyester fibers
- Color: White

Supply:
5

Characteristics	Height mm (in.)	Width mm (in.)	Depth mm (in.)	Cut-out mm (in.)	References
G3 M1 synthetic fine filters	268 (10.55)	248 (9.76)	18 (0.71)	223 (8.78) x 223 (8.78)	NSYCAF223T

Anti-vandalism kit for HD metal grille



NSYCAAPVHD

- Fixings that help to prevent to open the grille from the outside with standard tools (EN 1627-1630:2011 Class 2).
- Quick installation without tools.
- Material: Steel with anticorrosive painting + plastic for fixing screws

Comment:
Not compatible with NSYSPLA150

Supply:
4 grip knob
4 clip nuts

Characteristics	References
Anti-vandalism kit for HD metal grille	NSYCAAPVHD



Download ProClima free software



e-brochure

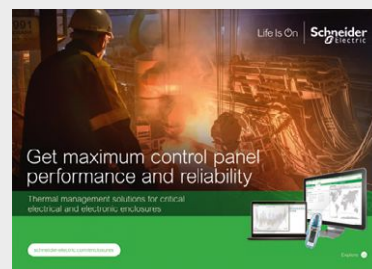

Get maximum control panel performance and reliability
Thermal management solutions for critical electrical and electronic enclosures **UE16MK06EN**

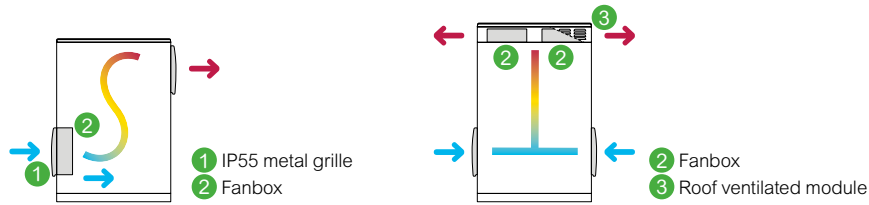

	S-Line				T-Line				
Architecture benefits	<ul style="list-style-type: none"> • Most common and competitive architecture • Maximum heat dissipation to extract 800 W-1000 W • ΔT° of 5°C (41°F) • Easy access to mount-dismount fanbox • Air flow in horizontal axis 				<ul style="list-style-type: none"> • High thermal extraction capacity up to 1500 W • Noise level with 1 fan: 55 dB when installed inside the upper airing module • ΔT° of 5°C (41°F) • Air flow in vertical axis 				
	IP55 metal grille		Fanbox		IP55 metal grille		Fanbox (1 filter NSYCAF190 for each Fanbox)		Roof airing module
	Door	Side	Door	Side	Door	Side			

Polyester outdoor HD enclosure									
References	Quantity to be installed				Quantity to be installed				References
NSYPHDT553	-	-	-	-	-	-	-	-	-
NSYPHDT553P	-	-	-	-	-	-	-	-	-
NSYPHDT753	-	-	-	-	-	-	-	-	-
NSYPHDT753P	1 to 2	-	1 to 2	-	1 to 2	-	1 to 2	-	-
NSYPHDT774	-	1 to 2	-	1 to 2	-	1 to 2	1 to 2	1	NSYPCVR74HD
NSYPHDT774P	1 to 2	1 to 2	1 to 2	1 to 2	1 to 2	1 to 2	1 to 2	1	NSYPCVR74HD
NSYPHDT776	-	1 to 2	-	1 to 2	-	1 to 2	1 to 2	1	NSYPCVR76HD
NSYPHDT776P	1 to 2	1 to 2	1 to 2	1 to 2	1 to 2	1 to 2	1 to 2	1	NSYPCVR76HD
NSYPHDT1054	-	1	-	1	-	1	1	1	NSYPCVR54HD
NSYPHDT1054P	1 to 2	1	1 to 2	1	1 to 2	1	1	1	NSYPCVR54HD
NSYPHDT1074	-	1 to 2	-	1 to 2	-	1 to 2	1 to 2	1	NSYPCVR74HD
NSYPHDT1074P	1 to 4	1 to 2	1 to 4	1 to 2	1 to 4	1 to 2	1 to 2	1	NSYPCVR74HD
NSYPHDT12124	-	1 to 3	-	1 to 3	-	1 to 3	1 to 3	1	NSYPCVR124HD
NSYPHDT12124P	1 to 4	1 to 3	1 to 4	1 to 3	1 to 4	1 to 3	1 to 3	1	NSYPCVR124HD
NSYPHDT12126	-	1 to 3	-	1 to 3	-	1 to 3	1 to 3	1	NSYPCVR126HD
NSYPHDT12126P	1 to 4	1 to 3	1 to 4	1 to 3	1 to 4	1 to 3	1 to 3	1	NSYPCVR126HD
NSYPHDT1254	-	1	-	1	-	1	1	1	NSYPCVR54HD
NSYPHDT1254P	1 to 3	1	1 to 3	1	1 to 3	1	1	1	NSYPCVR54HD
NSYPHDT1274	-	1 to 2	-	1 to 2	-	1 to 2	1 to 2	1	NSYPCVR74HD
NSYPHDT1274P	1 to 4	1 to 2	1 to 4	1 to 2	1 to 4	1 to 2	1 to 2	1	NSYPCVR74HD
NSYPHDT1276	-	1 to 2	-	1 to 2	-	1 to 2	1 to 2	1	NSYPCVR76HD
NSYPHDT1276P	1 to 4	1 to 2	1 to 4	1 to 2	1 to 4	1 to 2	1 to 2	1	NSYPCVR76HD
NSYPHDT15124	-	1 to 3	-	1 to 3	-	1 to 3	1 to 3	1	NSYPCVR124HD
NSYPHDT15124P	1 to 4	1 to 3	1 to 4	1 to 3	1 to 4	1 to 3	1 to 3	1	NSYPCVR124HD
NSYPHDT15126	-	1 to 3	-	1 to 3	-	1 to 3	1 to 3	1	NSYPCVR126HD
NSYPHDT15126P	1 to 4	1 to 3	1 to 4	1 to 3	1 to 4	1 to 3	1 to 3	1	NSYPCVR126HD
NSYPHDT1574	-	1 to 2	-	1 to 2	-	1 to 2	1 to 2	1	NSYPCVR74HD
NSYPHDT1574P	1 to 4	1 to 2	1 to 4	1 to 2	1 to 4	1 to 2	1 to 2	1	NSYPCVR74HD
NSYPHDT1576	-	1 to 2	-	1 to 2	-	1 to 2	1 to 2	1	NSYPCVR76HD
NSYPHDT1576P	1 to 4	1 to 2	1 to 4	1 to 2	1 to 4	1 to 2	1 to 2	1	NSYPCVR76HD
NSYPHDT2074	-	1 to 2	-	1 to 2	-	1 to 2	1 to 2	1	NSYPCVR74HD
NSYPHDT2074P	1 to 4	1 to 2	1 to 4	1 to 2	1 to 4	1 to 2	1 to 2	1	NSYPCVR74HD

Steel outdoor HD enclosure									
NSYS3HD8630	1 to 2	-	1 to 2	-	1 to 2	-	-	-	-
NSYS3HD8840	1 to 2	1 to 2	1 to 2	1 to 2	1 to 2	1 to 2	1 to 2	1	NSYS3CVR84HD
NSYS3HD10640	1 to 2	1 to 2	1 to 2	1 to 2	1 to 2	1 to 2	1	1	NSYS3CVR64HD
NSYS3HD10840	1 to 4	1 to 2	1 to 4	1 to 2	1 to 4	1 to 2	1 to 2	1	NSYS3CVR84HD
NSYSFHD12640	1 to 3	1 to 3	1 to 3	1 to 3	1 to 3	1 to 3	1	1	NSYSFCVR64HD
NSYSFHD12660	1 to 3	1 to 3	1 to 3	1 to 3	1 to 3	1 to 3	1	1	NSYSFCVR66HD
NSYSFHD12840	1 to 4	1 to 3	1 to 4	1 to 3	1 to 4	1 to 3	1 to 2	1	NSYSFCVR84HD
NSYSFHD12860	1 to 4	1 to 3	1 to 4	1 to 3	1 to 4	1 to 3	1 to 2	1	NSYSFECA66HD
NSYSFHD16660	1 to 4	1 to 4	1 to 4	1 to 4	1 to 4	1 to 4	1	1	NSYSFCVR66HD
NSYSFHD16840	1 to 4	1 to 4	1 to 4	1 to 3	1 to 4	1 to 3	1 to 2	1	NSYSFCVR84HD
NSYSFHD16860	1 to 4	1 to 4	1 to 4	1 to 4	1 to 4	1 to 4	1 to 2	1	NSYSFECA66HD
NSYSFHD20840	1 to 4	1 to 4	1 to 4	1 to 4	1 to 4	1 to 4	1 to 2	1	NSYSFCVR84HD
NSYSFHD1212402D	1 to 4	1 to 3	1 to 4	1 to 2	1 to 4	1 to 2	1 to 3	1	NSYSFCVR124HD
NSYSFHD1212602D	1 to 4	1 to 3	1 to 4	1 to 3	1 to 4	1 to 2	1 to 3	1	NSYSFCVR126HD
NSYSFHD1612402D	1 to 4	1 to 4	1 to 4	1 to 3	1 to 4	1 to 3	1 to 3	1	NSYSFCVR124HD
NSYSFHD1612602D	1 to 4	1 to 4	1 to 4	1 to 3	1 to 4	1 to 3	1 to 3	1	NSYSFCVR126HD

Technical changes reserved. Information provided without guarantee. Images are for illustrative purposes only.

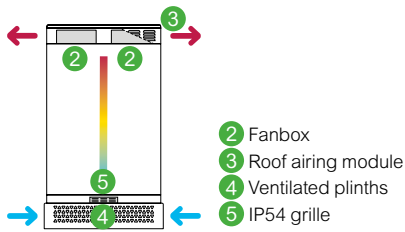

This table helps to configure thermal architectures, but it is highly recommended to use the ProClima Software to ensure the right thermal solution according to the selected architecture.

I-Line

- Integrated architecture particularly suitable for public areas
- High thermal extraction capacity up to 1500 W
- Noise level with 1 fan: 55 dB when installed inside the upper airing module
- High flow rate and extraction performance
- Air flow in vertical axis

IP54 outlet grille (NSYCAG223LPF + G3 filter NSYCAF223T)	Ventilated plinths	Fanbox (1 filter NSYCAF190 for each Fanbox)	Roof airing module
--	--------------------	---	--------------------

Quantity to be installed		References		Quantity to be installed		References	
-	-	-	-	-	-	-	-
-	-	-	-	-	-	-	-
-	-	-	-	-	-	-	-
-	-	-	-	-	-	-	-
1 to 2	1	NSYZZ274VHD	-	1 to 2	1	NSYPCVR74HD	-
1 to 2	1	NSYZZ274VHD	-	1 to 2	1	NSYPCVR74HD	-
1 to 2	1	NSYZZ276VHD	-	1 to 2	1	NSYPCVR76HD	-
1 to 2	1	NSYZZ276VHD	-	1 to 2	1	NSYPCVR76HD	-
1	1	NSYZZ254VHD	-	1	1	NSYPCVR54HD	-
1	1	NSYZZ254VHD	-	1	1	NSYPCVR54HD	-
1 to 2	1	NSYZZ274VHD	-	1 to 2	1	NSYPCVR74HD	-
1 to 2	1	NSYZZ274VHD	-	1 to 2	1	NSYPCVR74HD	-
1 to 3	1	NSYZZ2124VHD	-	1 to 3	1	NSYPCVR124HD	-
1 to 3	1	NSYZZ2124VHD	-	1 to 3	1	NSYPCVR124HD	-
1 to 3	1	NSYZZ2126VHD	-	1 to 3	1	NSYPCVR126HD	-
1 to 3	1	NSYZZ2126VHD	-	1 to 3	1	NSYPCVR126HD	-
1	1	NSYZZ254VHD	-	1	1	NSYPCVR54HD	-
1	1	NSYZZ254VHD	-	1	1	NSYPCVR54HD	-
1 to 2	1	NSYZZ274VHD	-	1 to 2	1	NSYPCVR74HD	-
1 to 2	1	NSYZZ274VHD	-	1 to 2	1	NSYPCVR74HD	-
1 to 2	1	NSYZZ276VHD	-	1 to 2	1	NSYPCVR76HD	-
1 to 2	1	NSYZZ276VHD	-	1 to 2	1	NSYPCVR76HD	-
1 to 3	1	NSYZZ2124VHD	-	1 to 3	1	NSYPCVR124HD	-
1 to 3	1	NSYZZ2124VHD	-	1 to 3	1	NSYPCVR124HD	-
1 to 3	1	NSYZZ2126VHD	-	1 to 3	1	NSYPCVR126HD	-
1 to 3	1	NSYZZ2126VHD	-	1 to 3	1	NSYPCVR126HD	-
1 to 2	1	NSYZZ274VHD	-	1 to 2	1	NSYPCVR74HD	-
1 to 2	1	NSYZZ274VHD	-	1 to 2	1	NSYPCVR74HD	-
1 to 2	1	NSYZZ276VHD	-	1 to 2	1	NSYPCVR76HD	-
1 to 2	1	NSYZZ276VHD	-	1 to 2	1	NSYPCVR76HD	-
1 to 2	1	NSYZZ274VHD	-	1 to 2	1	NSYPCVR74HD	-
1 to 2	1	NSYZZ274VHD	-	1 to 2	1	NSYPCVR74HD	-

1	1	NSYSPFVX6200	NSYSPLVX6200	-	-	-
1 to 2	1	NSYSPFVX8200	NSYSPLVX4200	1 to 2	1	NSYS3CVR84HD
1	1	NSYSPFVX6200	NSYSPLVX4200	1	1	NSYS3CVR64HD
1	1	NSYSPFVX8200	NSYSPLVX4200	1 to 2	1	NSYS3CVR84HD
1	1	NSYSPFVX6200	NSYSPLVX4200	1	1	NSYSFCVR64HD
1	1	NSYSPFVX6200	NSYSPLVX6200	1	1	NSYSFCVR66HD
1 to 2	1	NSYSPFVX8200	NSYSPLVX4200	1 to 2	1	NSYSFCVR84HD
1 to 2	1	NSYSPFVX8200	NSYSPLVX6200	1 to 2	1	NSYSFECA66HD
1	1	NSYSPFVX6200	NSYSPLVX6200	1	1	NSYSFCVR66HD
1 to 2	1	NSYSPFVX8200	NSYSPLVX4200	1 to 2	1	NSYSFCVR84HD
1 to 2	1	NSYSPFVX8200	NSYSPLVX6200	1 to 2	1	NSYSFECA66HD
1 to 2	1	NSYSPFVX8200	NSYSPLVX4200	1 to 2	1	NSYSFCVR84HD
1 to 3	1	NSYSPFVX12200	NSYSPLVX4200	1 to 3	1	NSYSFCVR124HD
1 to 3	1	NSYSPFVX12200	NSYSPLVX6200	1 to 3	1	NSYSFCVR126HD
1 to 3	1	NSYSPFVX12200	NSYSPLVX4200	1 to 3	1	NSYSFCVR124HD
1 to 3	1	NSYSPFVX12200	NSYSPLVX6200	1 to 3	1	NSYSFCVR126HD

Technical changes reserved. Information provided without guarantee. Images are for illustrative purposes only.

EMC airing systems

EMC IP54 fan

- To effectively protect the equipment against electromagnetic interference, the EMC fan is equipped with:
 - a steel frame covering the plastic elements (self-extinguishing ABS according to standard UL94 V0),
 - a metal grille attached to the frame,
 - a beryllium gasket to ensure conductivity between the perimeter of the fan unit and the enclosure
- Ingress protection rating (according to IEC 60529): IP54

For more details see [page 458](#)



NSY17990

Characteristics	Flow rate		Voltage (V)	Dimensions		References
	m ³ /h	(ft ³ /min)		External mm (in.)	Cut-out mm (in.)	
EMC IP54 fan	61	(35.90)	230	145 (5.71) x 145 (5.71) x 70 (2.76)	126 (4.96) x 126 (4.96)	NSY17990
EMC IP54 fan	156	(91.82)	230	252 (9.92) x 252 (9.92) x 97 (3.82)	224 (8.82) x 224 (8.82)	NSY17991
EMC IP54 fan	480	(282.52)	230	320 (12.60) x 320 (12.60) x 150 (5.91)	292 (11.50) x 292 (11.50)	NSY17992

EMC IP54 fan

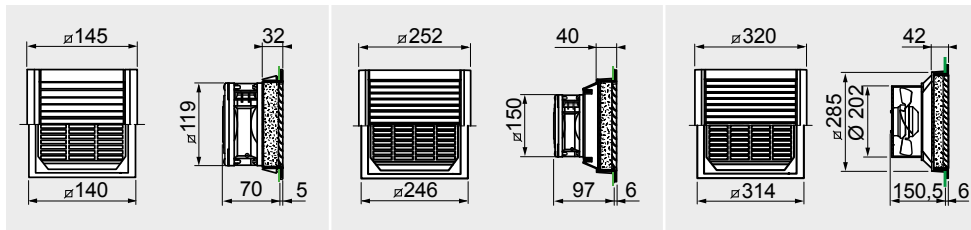

EMC IP54 outlet grille

- Grille equipped with:
 - a steel frame covering the plastic elements (self-extinguishing ABS according to standard UL 94 V-0),
 - a metal grille attached to the frame,
 - a beryllium gasket to ensure conductivity between the perimeter of the fan unit and the enclosure
- Ingress protection rating (according to IEC 60529): IP54



NSY17996

Characteristics	Dimensions		References
	External mm (in.)	Cut-out mm (in.)	
EMC IP54 outlet grille	145 (5.71) x 145 (5.71) x 70 (2.76)	126 (4.96) x 126 (4.96)	NSY17996
EMC IP54 outlet grille	252 (9.92) x 252 (9.92) x 97 (3.82)	224 (8.82) x 224 (8.82)	NSY17997
EMC IP54 outlet grille	320 (12.60) x 320 (12.60) x 150 (5.91)	292 (11.50) x 292 (11.50)	NSY17998

EMC IP55 cover

- This solution provides protection against electromagnetic interference and ensures IP55 ingress protection.
- The EMC cover is installed on the fans or standard IP54 outlet grilles.
- The cover is made of painted steel for outdoor use and completely covers the fan or outlet grille.
- Conductivity is obtained by means of:
 - a conductive painting (2 Ω),
 - a conductive copper braid.
- Color: RAL 7035 grey
- Ingress protection rating (according to IEC 60529): IP55
- Mechanical protection rating (according to IEC 62262): IK10
- Certifications: UL 508A Type 3R

⁽¹⁾ Values given for a fan powered at 230 V. For other voltages, the values are similar

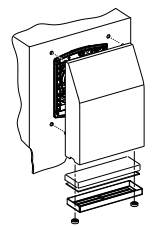

NSYCAP223LE

Characteristics	Flow rate m ³ /h (ft ³ /min) with cover ⁽¹⁾		Dimensions		References
	Free	With 1 outlet grille	External mm (in.)	Cut-out mm (in.)	
Sheet steel painted for outdoor applications, RAL 7035 grey	110	82	350 (13.78) x 305 (12.01) x 80 (3.15)	223 (8.78) x 223 (8.78)	NSYCAP223LE
Sheet steel painted for outdoor applications, RAL 7035 grey	165	123	350 (13.78) x 305 (12.01) x 80 (3.15)	223 (8.78) x 223 (8.78)	NSYCAP223LE
Sheet steel painted for outdoor applications, RAL 7035 grey	316	265	430 (16.93) x 373 (14.68) x 105 (4.13)	291 (11.46) x 291 (11.46)	NSYCAP291LE
Sheet steel painted for outdoor applications, RAL 7035 grey	502	430	430 (16.93) x 373 (14.68) x 105 (4.13)	291 (11.46) x 291 (11.46)	NSYCAP291LE

Dimensions of IP54 and EMC covers

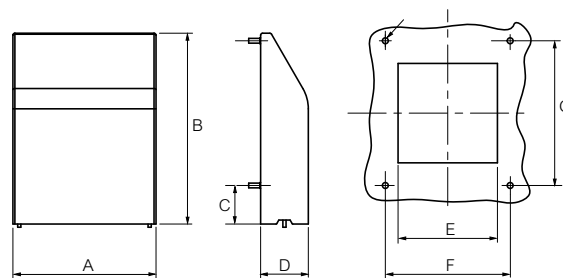

Dimensions mm (in.)							Cover references			
A	B	C	D	E	F	G	No. of fixing points	IP55	EMC	
180 (7.09)	240 (9.45)	49 (1.93)	49 (1.93)	49 (1.93)	157 (6.18)	182 (7.16)	4	NSYCAP125LZF	NSYCAP125LXF	NSYCAP125LE
305 (12.01)	350 (13.78)	61 (2.40)	61 (2.40)	61 (2.40)	283 (11.14)	280 (11.02)	8	NSYCAP223LZF	NSYCAP223LXF	NSYCAP223LE
373 (14.68)	430 (16.93)	73 (2.87)	73 (2.87)	73 (2.87)	351 (13.82)	348 (13.70)	8	NSYCAP291LZF	NSYCAP291LXF	NSYCAP291LE

Spare filter for cover

⁽¹⁾ Values given for a fan powered at 230 V. For other voltages, the values are similar

Supply:
5 items per kit



NSYCAF125L55

Characteristics	Flow rate m ³ /h (ft ³ /min) with cover ⁽¹⁾		Dimensions		References
	Free	With 1 outlet grille	External mm (in.)	Cut-out mm (in.)	
Spare filter for cover	74 (43.56)	53 (31.20)	240 (9.45) x 180 (7.09) x 60 (2.36)	125 (4.92) x 125 (4.92)	NSYCAF125L55
Spare filter for cover	110 (64.74)	82 (48.26)	350 (13.78) x 305 (12.01) x 80 (3.15)	223 (8.78) x 223 (8.78)	NSYCAF223L55
Spare filter for cover	165 (97.12)	123 (72.40)	350 (13.78) x 305 (12.01) x 80 (3.15)	223 (8.78) x 223 (8.78)	NSYCAF223L55
Spare filter for cover	316 (185.99)	265 (155.97)	430 (16.93) x 373 (14.68) x 105 (4.13)	291 (11.46) x 291 (11.46)	NSYCAF291L55
Spare filter for cover	502 (295.47)	430 (253.09)	430 (16.93) x 373 (14.68) x 105 (4.13)	291 (11.46) x 291 (11.46)	NSYCAF291L55

Fan

⁽¹⁾ Values given for a fan powered at 230 V. For other voltages, the values are similar

• Color: RAL 7035 grey



NSYCVF85M230PF

Characteristics	Flow rate m ³ /h (ft ³ /min) with cover ⁽¹⁾		Dimensions		References
	Free	With 1 outlet grille	External mm (in.)	Cut-out mm (in.)	
Fan	74 (43.56)	53 (31.20)	240 (9.45) x 180 (7.09) x 60 (2.36)	125 (4.92) x 125 (4.92)	NSYCVF85M230PF
Fan	110 (64.74)	82 (48.26)	350 (13.78) x 305 (12.01) x 80 (3.15)	223 (8.78) x 223 (8.78)	NSYCVF165M230PF
Fan	165 (97.12)	123 (72.40)	350 (13.78) x 305 (12.01) x 80 (3.15)	223 (8.78) x 223 (8.78)	NSYCVF300M230PF
Fan	316 (185.99)	265 (155.97)	430 (16.93) x 373 (14.68) x 105 (4.13)	291 (11.46) x 291 (11.46)	NSYCVF560M230PF
Fan	502 (295.47)	430 (253.09)	430 (16.93) x 373 (14.68) x 105 (4.13)	291 (11.46) x 291 (11.46)	NSYCVF850M230PF

Grille

⁽¹⁾ Values given for a fan powered at 230 V. For other voltages, the values are similar

• Color: RAL 7035 grey



NSYCAC125L55

Characteristics	Flow rate m ³ /h (ft ³ /min) with cover ⁽¹⁾		Dimensions		References
	Free	With 1 outlet grille	External mm (in.)	Cut-out mm (in.)	
Grille	74 (43.56)	53 (31.20)	240 (9.45) x 180 (7.09) x 60 (2.36)	125 (4.92) x 125 (4.92)	NSYCAC125L55
Grille	110 (64.74)	82 (48.26)	350 (13.78) x 305 (12.01) x 80 (3.15)	223 (8.78) x 223 (8.78)	NSYCAC223L55
Grille	165 (97.12)	123 (72.40)	350 (13.78) x 305 (12.01) x 80 (3.15)	223 (8.78) x 223 (8.78)	NSYCAC223L55
Grille	316 (185.99)	265 (155.97)	430 (16.93) x 373 (14.68) x 105 (4.13)	291 (11.46) x 291 (11.46)	NSYCAC291L55
Grille	502 (295.47)	430 (253.09)	430 (16.93) x 373 (14.68) x 105 (4.13)	291 (11.46) x 291 (11.46)	NSYCAC291L55

Fans by components

Fans

- Free flow without filter or grille: 170 (100.06 ft³/min) m³/h.
- Two models according to the input voltage: 230 and 115 V, 50-60 Hz.
- Ingress protection rating: IP20 according to IEC 60529.
- Options: IP20 outlet grille (ABS, black) and filter (black polyurethane foam).

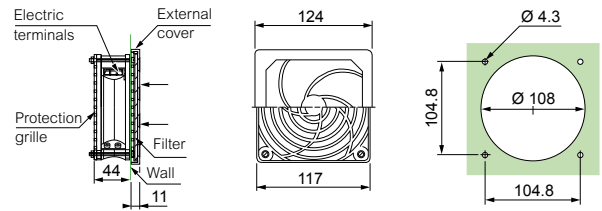

NSYCVF65M115PF

Characteristics	Flow rate m ³ /h (ft ³ /min)	Voltage (V)	References
Fan	65 (38.26)	115	NSYCVF65M115PF
Fan	65 (38.26)	230	NSYCVF65M230PF

Fan accessories



NSYCAF108

Characteristics	Dimensions External mm (in.)	References
Outlet grille	124 (4.88) x 124 (4.88) x 11 (0.43)	NSYCAF108LP
Filter	-	NSYCAF108

Airing kit

- Ingress protection rating: IP33 according to IEC 60529.
- Mechanical protection rating: IK10 according to IEC 62262.
- Overall flow rate: 54 m³/h.

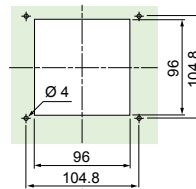

Supply:

- One 120 (4.72) x 120 (4.72) x 38 (1.50) mm (in.) fan, 230 V - 50/60 Hz, free flow rate 170 (100.06) m³/h (ft³/min),
- Two 120 (4.72) x 120 (4.72) mm (in.) metal grilles, RAL 7035 grey,
- Two 115 (4.53) x 98 (3.86) mm (in.) anti-insect filters, stainless-steel 304L cable Ø 0.32 (0.01) mm (in.) braided,
- 1.07 (0.04) mm (in.) meshes,
- 1 power cord,
- The fixings required for installation.



NSYCVF54M230MM2

Characteristics	Flow rate m ³ /h (ft ³ /min)	Voltage (V)	References
Airing kit	54 (31.78)	230	NSYCVF54M230MM2

Top hood with fan and cover

- Ingress protection rating: IP54 according to IEC 60529.
- Certification: UL.
- Installation: Installation and removal from the outside.
- Electric power: 85 W.
- Noise level: 64 dB (A).

Comment:

Flow rate measured without counter-pressure

Supply:

Delivered with fixings and connection terminal block.



NSYCVF570M115MF

Characteristics	Weight kg (lbs.)	Flow rate m ³ /h (ft ³ /min)	Voltage (V)	References
Top hood with fan and cover	5.8 (12.79)	570 (335.49)	115	NSYCVF570M115MF
Top hood with fan and cover	5.8 (12.79)	575 (338.43)	230	NSYCVF575M230MF

Fan motor



NSYCVF156M230



NSYCVF156M115

- Turbine-type fan motor for airing/extraction.

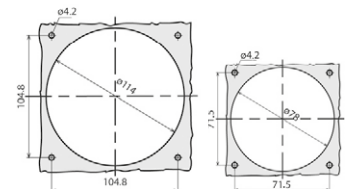

Characteristics	Flow rate m ³ /h (ft ³ /min)	Voltage (V/Hz)	Absorbed power (W)	Noise level (dB)	External dimensions mm (in.)	References
Fan motor	156 (91.82)	230/50-60	17/15	42	120 (4.72) x 120 (4.72) x 38 (1.50)	NSYCVF156M230
Fan motor	156 (91.82)	115/50-60	17/15	42	120 (4.72) x 120 (4.72) x 38 (1.50)	NSYCVF156M115
Fan motor	35 (20.60)	230/50-60	16/14	32	80 (3.15) x 80 (3.15) x 25 (0.98)	NSYCVF35M230
Fan motor	35 (20.60)	115/50-60	16/14	32	80 (3.15) x 80 (3.15) x 25 (0.98)	NSYCVF35M115

Fan accessories

Outlet grille

- Outlet filter kit for enclosure airing.
- For coupling to fans use **NSYCVF156M●●●** and **NSYCVF35M●●●**.



NSYCAG114LPF

Characteristics	External dimensions mm (in.)	References
Outlet grille	120 (4.72) x 120 (4.72) x 38 (1.50)	NSYCAG114LPF
Outlet grille	80 (3.15) x 80 (3.15) x 25 (0.98)	NSYCAG78LPF

Rear protective grille

- Protective grille for enclosure fan motor
- For coupling to fans use **NSYCVF156M●●●** and **NSYCVF35M●●●**.

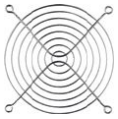

NSYCVA114M



NSYCVA78M

Characteristics	External dimensions mm (in.)	References
Rear protective grille	120 (4.72) x 120 (4.72) x 38 (1.50)	NSYCVA114M
Rear protective grille	80 (3.15) x 80 (3.15) x 25 (0.98)	NSYCVA78M

Fan connection cable

- For coupling to the connection terminal of the fan motors.



NSYCVAC100

Characteristics	References
Fan connection cable, length = 1 (39.37) m (in.)	NSYCVAC100

Air circulation for internal forced convection

Circulation fan

User protection according to DIN 31001.

Dimensions:

- Fan: 119 (4.68) x 119 (4.68) x 38 (1.50) mm (in.).
- Collar: Length: 140 (5.51) mm (in.); Fixing center-to-center distance: 130 (5.12) mm (in.).
- Motor mounted on ball bearing



NSYCVF170M115

Characteristics	Flow rate m ³ /h (ft ³ /min)	Voltage (V)	Weight. kg (lbs.)	P (W)	dB (A)	References
Circulation fan	170 (100.06)	115	0.82 (1.81)	17	41	NSYCVF170M115
Circulation fan	170 (100.06)	230	0.82 (1.81)	17	41	NSYCVF170M230

Comment:

⁽¹⁾ Free flow.

Tangential fan, 19" 2 U

- Air is sucked in from the front, filtered and forced vertically through the equipment.

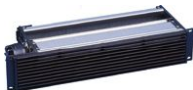

NSYAVG2U300

Characteristics	Flow rate m ³ /h (ft ³ /min)	Voltage (V)	P (W)	References
Tangential fan, 19" 2 U	300 (176.57)	230 (50-60 Hz)	37	NSYAVG2U300

Comment:

⁽¹⁾ Flow rate measured without counter-pressure.

Supply:

Delivered with fixings and connection terminal block.

- Increases the speed of upward air flow, in particular between trays with cards.
- Frontal operation LED.
- It is advisable to install slides, ref. **NSYGB140** to guarantee optimal support of the fan.



NSYAVD1U480



NSYAVD1U970

Characteristics	Flow rate m ³ /h (ft ³ /min)	Voltage (V)	No.	Weight. kg (lbs.)	P (W)	I (mA)	dB (A)	Depth mm (in.)	References
Circulation fan, 19" 1 U D210	486 (286.05)	230	3	3.3 (7.28)	45	300	43	208 (8.19)	NSYAVD1U480
Circulation fan, 19" 1 U D330	972 (572.10)	230	6	5.5 (12.13)	90	600	44	330 (12.99)	NSYAVD1U970
Circulation fan, 19" 1 U D452	1458 (858.15)	230	9	7.8 (17.20)	135	900	45	452 (17.80)	NSYAVD1U1450
Circulation fan, 19" 1 U D210 ⁽¹⁾	552 (324.90) ⁽²⁾	48 (DC)	3	3.3 (7.28)	21.3	330	43	208 (8.19)	NSYAVD1U550M48

Comment:

Flow rate measured without counter-pressure.

⁽¹⁾ Direct current.

Supply:

Delivered without connection cord

Fan 38 (22.37) m³/h (ft³/min)

Comment: Adding the Dust Sensor will decrease the flow rate by nearly 10%.



★ Warning: The fan NSYCVF38M230DG and NSYCVF38M115DG and NSYCVF38M230PF MUST NOT be connected to a power conversion module, an inverter or UPS!

Flow curves

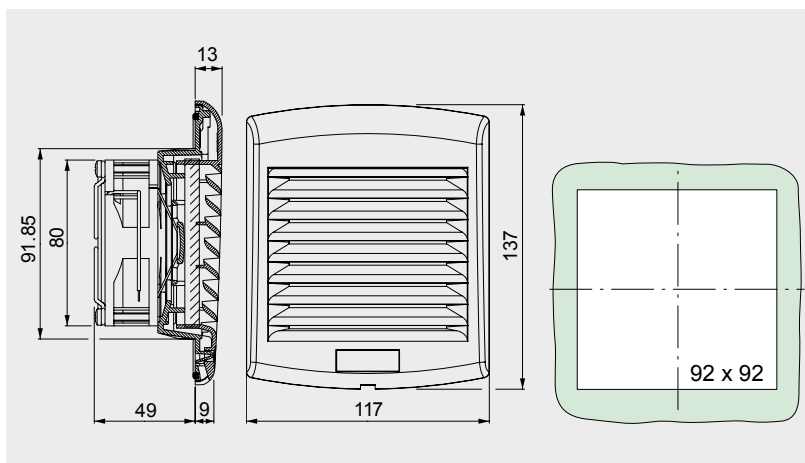
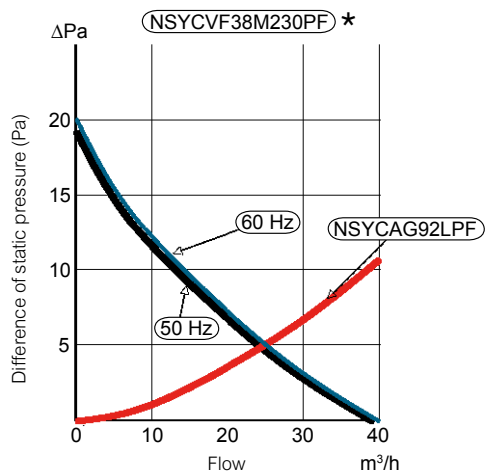

Fan 85 (50.03) m³/h (ft³/min)

Comment: Adding the Dust Sensor will decrease the flow rate by nearly 5%.

Flow curves

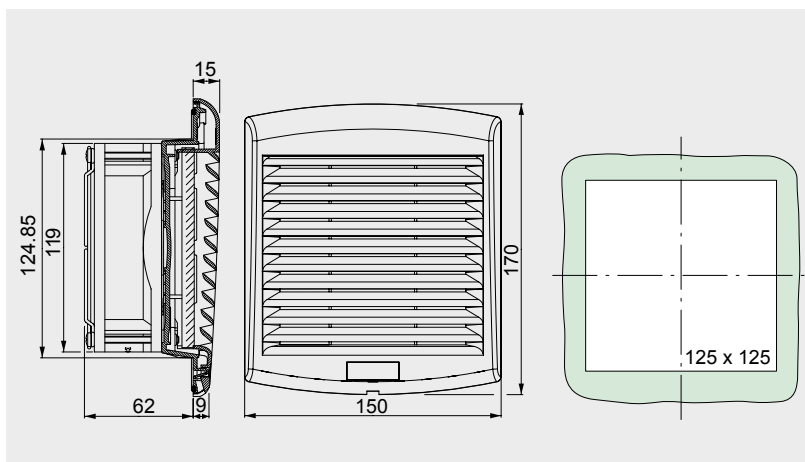
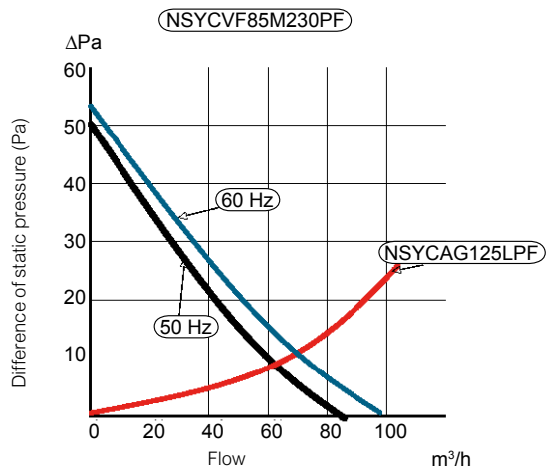

Fan 165 (97.12) m³/h (ft³/min)

Comment: Adding the Dust Sensor will decrease the flow rate by nearly 5%.

Flow curves

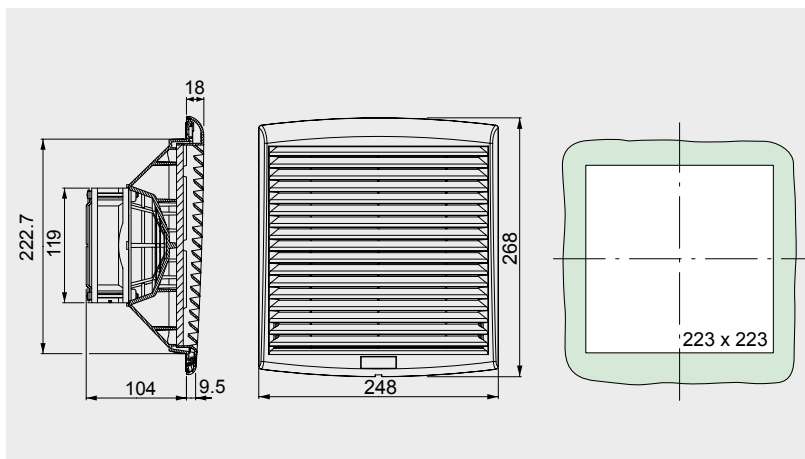
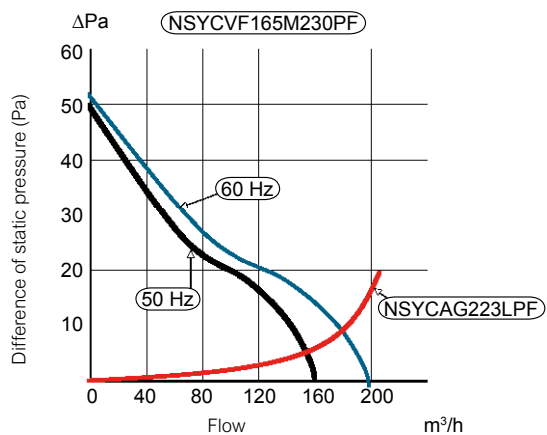

Fan 300 (176.57) m³/h (ft³/min)

Comment: Adding the Dust Sensor will decrease the flow rate by nearly 5%.

Flow curves

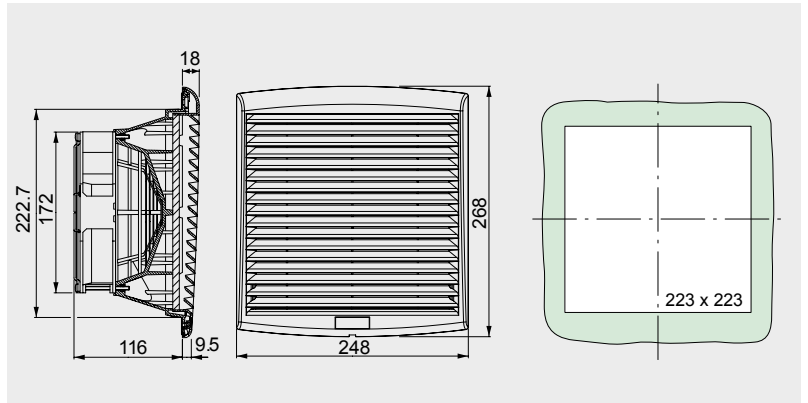
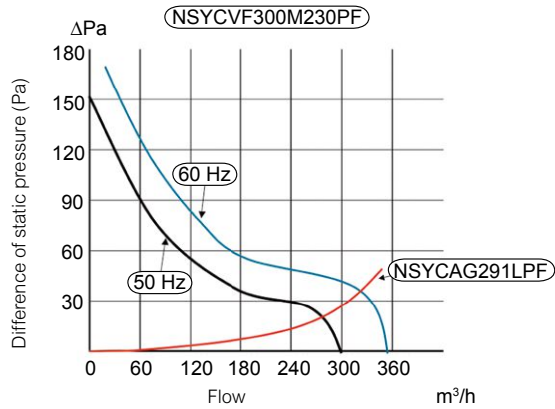

Fan 560 (329.60)-850 (500.29) m³/h (ft³/min)

Comment: Adding the Dust Sensor will decrease the flow rate by nearly 5%.

Flow curves

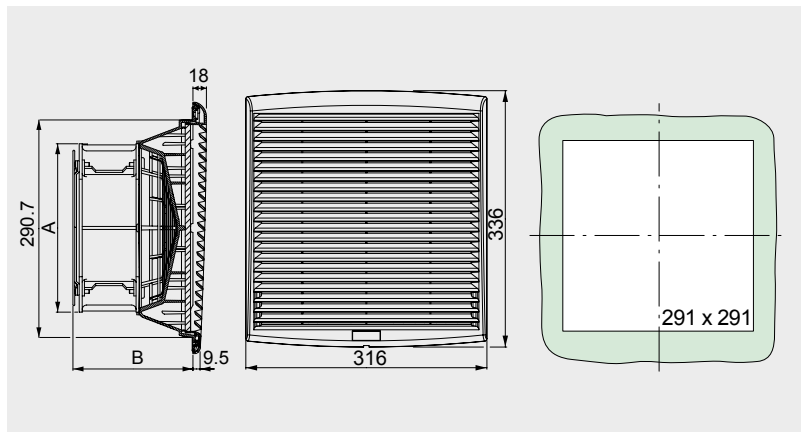
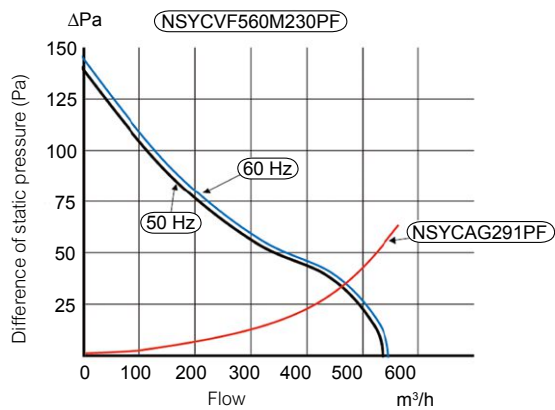

Flow curves

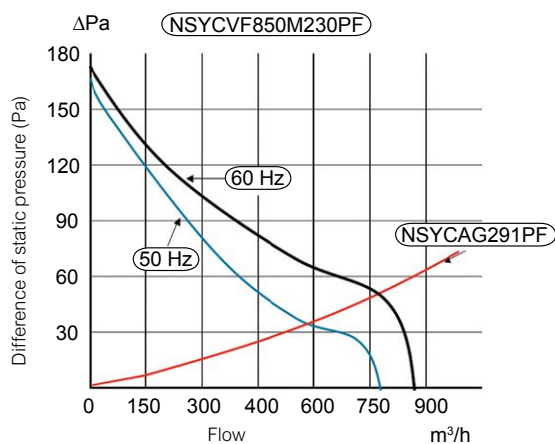

References	A mm (in.)	B mm (in.)
NSYCVF560M230PF	225 (8.86)	160.5 (6.32)
NSYCVF560M115PF	225 (8.86)	160.5 (6.32)
NSYCVF850M230PF	280 (11.02)	162 (6.38)
NSYCVF850M115PF	280 (11.02)	162 (6.38)

Metal louver plate, rectangular

- Material: Steel
- Structured finish, epoxy polyester painting, RAL 7035 grey
- Ingress protection rating (according to IEC 60529): IP20
- Installation: On the sides of the enclosure. Fixing by screws.

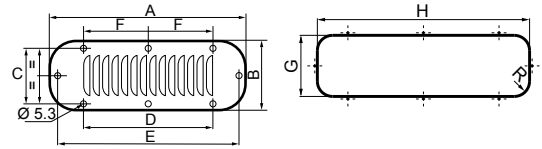

Supply:
1 metal louver and fixing elements



NSYCAG110X46M

Characteristics	A mm (in.)	B mm (in.)	C mm (in.)	D mm (in.)	E mm (in.)	F mm (in.)	G mm (in.)	H mm (in.)	R mm (in.)	References
Metal louver plate, rectangular	144 (5.67)	62 (2.44)	36 (1.42)	110 (4.33)	-	-	110 (4.33)	46 (1.81)	10 (0.39)	NSYCAG110X46M
Metal louver plate, rectangular	208 (8.19)	90 (3.54)	72 (2.84)	94 (3.70)	190 (7.48)	-	180 (7.09)	62 (2.44)	18 (0.71)	NSYCAG180X62M
Metal louver plate, rectangular	244 (9.61)	90 (3.54)	72 (2.84)	130 (5.12)	226 (8.90)	-	216 (8.50)	62 (2.44)	18 (0.71)	NSYCAG216X62M
Metal louver plate, rectangular	345 (13.58)	118 (4.65)	100 (3.94)	231 (9.09)	327 (12.87)	115.5 (4.55)	317 (12.48)	90.5 (3.56)	30 (1.18)	NSYCAG317X91M
Metal louver plate, rectangular	345 (13.58)	148 (5.83)	130 (5.12)	231 (9.09)	327 (12.87)	115.5 (4.55)	317 (12.48)	120 (4.72)	30 (1.18)	NSYCAG317X120M
Metal louver plate, rectangular	445 (17.52)	148 (5.83)	130 (5.12)	267 (10.51)	427 (16.81)	148.5 (5.85)	417 (16.42)	120 (4.72)	30 (1.18)	NSYCAG417X120M

Metal louver plate, square

- Ingress protection rating (according to IEC 60529): IP23

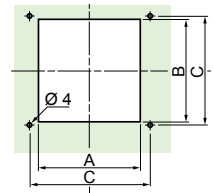

Supply:
One metal louver



NSYCAG104X95LM

Characteristics	Dimensions mm (in.)	A mm (in.)	B mm (in.)	C mm (in.)	Slot width mm (in.)	No. of slots	References
Metal louver plate, square	120 (4.72) x 120 (4.72)	95 (3.74)	90 (3.54)	104.8 (4.13)	90 (3.54)	5	NSYCAG104X95LM
Metal louver plate, square	160 (6.30) x 160 (6.30)	110 (4.33)	130 (5.12)	140 (5.51)	100 (3.94)	5	NSYCAG130X110LM
Metal louver plate, square	220 (8.66) x 220 (8.66)	190 (7.48)	170 (6.69)	200 (7.87)	180 (7.09)	5	NSYCAG170X190LM

Anti-insect filters for metal louver plate, square

- Material: Stainless-steel 304L Ø 0.32 (0.01) mm (in.) wire mesh, 1.07 (0.04) mm (in.), thickness 0.6 (0.02) mm (in.)
- Ingress protection rating (according to IEC 60529): IP33
- Installation: Between the enclosure and the metal louver

Supply:
One anti-insect filter



NSYCAF104X95X

Characteristics	External dimensions mm (in.)	Weight	References
Anti-insect filters for metal louver plate, square	98 (3.86) x 115 (4.53)	0.8 (1.76) kg (lbs.)/m ²	NSYCAF104X95X
Anti-insect filters for metal louver plate, square	133 (5.24) x 158 (6.22)	0.8 (1.76) kg (lbs.)/m ²	NSYCAF130X110X
Anti-insect filters for metal louver plate, square	197 (7.76) x 215 (8.46)	0.8 (1.76) kg (lbs.)/m ²	NSYCAF170X190X

Roof elevators

Allow the roof to be raised, providing natural airing.

- Material: Zinc-coated steel
- They are screwed onto the structure of SF enclosures at the roof fixing points

Supply:
4 elevators

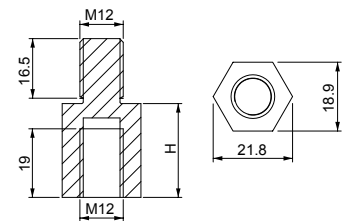

NSYRE26

Characteristics	Top elevation mm (in.)	References
Roof elevators	26 (1.02)	NSYRE26
Roof elevators	60 (2.36)	NSYRE60

Hood for natural airing



NSYCAC228RMF

Natural airing device for coupling to the top of metal floor-standing enclosures. Solution for combination with the airing slots.

- Material: Steel
- Finish: Structured finish, epoxy polyester painting, RAL 7035 grey
- Ingress protection rating (according to IEC 60529): IP54
- Installation: Fixing to the top by means of caged nuts and special screws

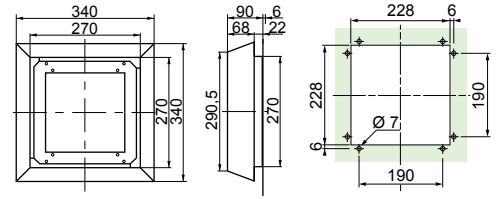

Supply:

One hood for natural airing and fixing elements

Characteristics	Weight	References
Hood for natural airing	4.6 (10.14) kg (lbs.)	NSYCAC228RMF
Spare filter	–	NSYCAF228R

Plastic airing louvres

Four models available according to IP rating, in vertical position.



NSYCAG45LP

NSYCAG35LP

NSYCAG38LP

NSYCAG33LP

NSYCAG19LP

Characteristics	Ingress protection rating	Cut-out Ø mm (in.)	References
Plastic airing louvres	IP22	45.5 (1.79)	NSYCAG45LP
Plastic airing louvres	IP30/44	35 (1.38)	NSYCAG35LP
Plastic airing louvres	IP45	38 (1.50)	NSYCAG38LP
Plastic airing louvres	IP44	33 (1.30)	NSYCAG33LP
	IP45	19 (0.75)	NSYCAG19LP

Supply:

References by unit. Order by multiples of 2 units (2, 4, 6, etc)

Sealed anti-condensation valve

Controls the pressure to avoid condensation following internal temperature increase.

- Material: PA6-V-2, acrylic co-polymer membrane, water- and oil-repelling
- Ingress protection rating: IP68
- Temperature of use: -40°C (-40°F) ... + 105°C (221°F)



NSYCAG12LPH2

Characteristics	Cut-out Ø mm	Permeability	Pressure difference	Minor pack.	References
Sealed anti-condensation valve	M12	16 litres/h	$\Delta P < 1$ bar	10	NSYCAG12LPH1
Sealed anti-condensation valve	M12	120 litres/h	$\Delta P < 0.1$ bar	10	NSYCAG12LPH2

Choose air-to-air exchangers to take advantage of cooler ambient temperatures, such as in food and beverage plants, to evacuate large amounts of heat while retaining the independence of the internal and external air circuits.



Air-to-air exchangers: A new range energy efficient



Higher efficiency through improved design

- With an updated external grill design, and by positioning cooling closer to critical equipment, such as speed drives, ClimaSys now provides better flow, better cooling, and higher energy efficiency.



Protection

- All side-mounted models are IP55 internally according to EN 60529.



Faster installation

- A number of design improvements reduce installation time. Mounting requires single cut-outs and a minimum of screws. Wiring is accomplished with smart interconnects.



New certifications and declarations

- CE
- EAC



Simplicity saves you time

- Our free ProClima thermal calculation software makes specification simple and fast. A new thermal solutions module integrates calculation for cooling and control devices, helping you maximize the energy efficiency of your systems.

Air-to-air exchangers, side-mounted models



Side-mounted models				
Characteristics	<ul style="list-style-type: none"> The air-to-air exchanger can be used in heavily polluted environments provided that the ambient temperature is at least 10°C (50°F) lower than the internal temperature wanted. Main components: Thermostat adjustment system, exchanger cassette, fans for internal and external circuits of the enclosure. 			
Material	Painted zinc-coated steel			
Color	RAL 7035 grey			
Ingress protection rating (according to IEC 60529)	IP55			
Certifications and declarations	CE, EAC			
Installation	Indoor. For outdoor applications or other surface finishes please consult us.			
Cooling characteristics				
Specific power	22 W/K	36 W/K	50 W/K	80 W/K
Air flow of the internal circuit (enclosure)	280 (164.80) m³/h (ft³/min)	570 (335.49) m³/h (ft³/min)	600 (353.15) m³/h (ft³/min)	1050 (618.01) m³/h (ft³/min)
Air flow of the external circuit (ambient)	280 (164.80) m³/h (ft³/min)	570 (335.49) m³/h (ft³/min)	600 (353.15) m³/h (ft³/min)	1050 (618.01) m³/h (ft³/min)
Thermostat type	-	Mechanical	Mechanical	Mechanical
Temperature setting range	-	+5°C (41°F) ... +60°C (140°F)	+5°C (41°F) ... +60°C (140°F)	+5°C (41°F) ... +60°C (140°F)
Temperature range of external circuit (ambient)	-5°C (23°F) ... +55°C (131°F)	-5°C (23°F) ... +55°C (131°F)	-5°C (23°F) ... +55°C (131°F)	-5°C (23°F) ... +55°C (131°F)
Type of fluid	Air	Air	Air	Air
Electric characteristics				
Input voltage	1 x 230 V / 50-60 Hz	1 x 230 V / 50-60 Hz	1 x 230 V / 50-60 Hz	1 x 230 V / 50-60 Hz
Rated current	0.5 A	0.7 A	0.7 A	1.1 A
Power consumption	72 W	160 W	160 W	240 W
Thermal protection recommended (fuse)	T1 A	T1 A	T1 A	T2 A
Physical characteristics				
External dimensions (H x W x D)	413 (16.26) x 189 (7.44) x 149 (5.87) mm (in.)	771 (30.35) x 316 (12.44) x 103 (4.06) mm (in.)	771 (30.35) x 316 (12.44) x 103 (4.06) mm (in.)	1260 (49.61) x 317 (12.48) x 148 (5.83) mm (in.)
Protection degree IP internal /external (according to IEC 60529)	IP55 / IP22	IP55 / IP22	IP55 / IP22	IP55 / IP22
Noise level	59 dB	62 dB	62 dB	64 dB
Weight of unit	7 (15.43) kg (lbs.)	10 (22.05) kg (lbs.)	10 (22.05) kg (lbs.)	17 (37.48) kg (lbs.)
References				
	NSYCEA22E	NSYCEA36	NSYCEA50	NSYCEA80

Choose air-to-water exchangers for especially difficult environments where there is no external air circuit available but a stable cold-water circuit can be supplied.



Air-to-water exchangers: For highly polluted environments



Many mounting options give you the right fit

- Air-to-water exchangers offer roof and side-mounted options.



Certifications and declarations

- CE.
- EAC

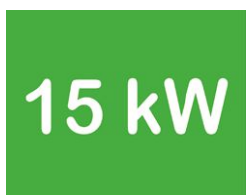

Extended ratings to meet any challenge

- Provide options for up to 15 kW of cooling power, among the world's highest power ratings for air-to-water exchangers.



Protection

- All side-mounted models are IP55-protected internally and externally according EN 60529. Top-mounted models are IP54.



New material options adapt to any application

- Air-to-water exchangers can be provided in the same material as electrical enclosures (for example stainless-steel) for a homogeneous appearance and thermal performance.

Air-to-water exchangers, side-mounted models



Characteristics		Side-mounted models				
		<ul style="list-style-type: none"> Main components: Thermostat adjustment system, Exchange cassette, fans for internal circuits of the enclosure, protection device against possible leaks. Eyebolts included in all models. 				
Material	RAL 7035 grey painted zinc-coated steel or stainless-steel					
Ingress protection rating (according to IEC 60529)	IP55					
Certifications and declarations	<ul style="list-style-type: none"> CE declaration UL (only references ending with UL) EAC 					
Installation	Indoor. For outdoor applications or other surface finishes please consult us.					
Cooling characteristics						
Cooling power W10A35	1000 W	1750 W	2500 W	3500 W	4500 W	
Hydraulic circuit maximum pressure	5 bar	5 bar	5 bar	5 bar	5 bar	
Internal airflow	330 (194.23) m ³ /h (ft ³ /min)	570 (335.49) m ³ /h (ft ³ /min)	860 (506.18) m ³ /h (ft ³ /min)	1050 (618.01) m ³ /h (ft ³ /min)	1450 (853.44) m ³ /h (ft ³ /min)	
Thermostat type	Mechanical	Mechanical	Mechanical	Mechanical	Mechanical	
Temperature setting range	+20°C (68°F) ... +46°C (115°F)	+20°C (68°F) ... +46°C (115°F)	+20°C (68°F) ... +46°C (115°F)	+20°C (68°F) ... +46°C (115°F)	+20°C (68°F) ... +46°C (115°F)	
Temperature range external circuit (ambient)	+1°C (34°F) ... +70°C (158°F)	+1°C (34°F) ... +70°C (158°F)	+1°C (34°F) ... +70°C (158°F)	+1°C (34°F) ... +70°C (158°F)	+1°C (34°F) ... +70°C (158°F)	
Type of fluid	Filtered water or glycolised water	Filtered water or glycolised water	Filtered water or glycolised water	Filtered water or glycolised water	Filtered water or glycolised water	
Water flow	150 l/h	150 l/h	500 l/h	500 l/h	500 l/h	
Pressure drop	0.1 bar	0.1 bar	0.3 bar	0.2 bar	0.2 bar	
Hydraulic connection	3/8" G	1/2" G	1/2" G	1/2" G	1/2" G	
Electric characteristics						
Input voltage	1 x 230 V / 50-60 Hz*	1 x 230 V / 50-60 Hz*	1 x 230 V / 50-60 Hz*	1 x 230 V / 50-60 Hz*	1 x 230 V / 50-60 Hz*	
Rated Intensity	0.17 A	0.36 A	0.33 A	0.55 A	0.71 A	
Power consumption absorbed W10A35	29 W	75 W	80 W	130 W	160 W	
Thermal protection recommended (fuse)	T2 A	T2 A	T2 A	T2 A	T2 A	
Physical characteristics						
External dimensions (H x W x D)	450 (17.72) x 310 (12.20) x 115 (4.53) mm (in.)	901 (35.47) x 398 (15.67) x 137 (5.39) mm (in.)	901 (35.47) x 398 (15.67) x 137 (5.39) mm (in.)	1148 (45.20) x 398 (15.67) x 163 (6.42) mm (in.)	1148 (45.20) x 398 (15.67) x 163 (6.42) mm (in.)	
Protection degree IP internal / external (according to IEC 60529)	IP55 / IP55	IP55 / IP55	IP55 / IP55	IP55 / IP55	IP55 / IP55	
Noise level	55 dB (A)	58 dB (A)	58 dB (A)	64 dB (A)	69 dB (A)	
Weight of unit	12 (26.46) kg (lbs.)	18 (39.68) kg (lbs.)	19 (41.89) kg (lbs.)	29 (63.93) kg (lbs.)	30 (66.14) kg (lbs.)	
References						
Steel	NSYCEW1K	NSYCEW1K8	NSYCEW2K5	NSYCEW3K5	NSYCEW4K5	
Stainless-steel	NSYCEWX1K	NSYCEWX1K8	NSYCEWX2K5	-	-	

Side-mounted model



Top Mounting model



Characteristics	Side-mounted models		Top Mounting model
	<ul style="list-style-type: none"> Main components: Thermostat adjustment system, Exchange cassette, fans for internal circuits of the enclosure, protection device against possible leaks. Eyebolts included in all models. 		
Material	RAL 7035 grey painted zinc-coated steel or stainless-steel		
Ingress protection rating (according to IEC 60529)	IP55		IP54
Certifications and declarations	<ul style="list-style-type: none"> CE declaration UL (only references ending with UL) EAC 		
Installation	Indoor. For outdoor applications or other surface finishes please consult us.		
Cooling characteristics			
Cooling power W10A35	6000 W	6000 W	2500 W
Hydraulic circuit maximum pressure	5 bar	8 bar	5 bar
Internal airflow	1450 (853.44) m ³ /h (ft ³ /min)	1450 (853.44) m ³ /h (ft ³ /min)	750 (441.43) m ³ /h (ft ³ /min)
Thermostat type	Mechanical	Mechanical	Mechanical
Temperature setting range	+20°C (68°F) ... +46°C (115°F)	+20°C (68°F) ... +46°C (115°F)	+20°C (68°F) ... +46°C (115°F)
Temperature range external circuit (ambient)	+1°C (34°F) ... +70°C (158°F)	+1°C (34°F) ... +70°C (158°F)	+1°C (34°F) ... +70°C (158°F)
Type of fluid	Filtered water or glycolised water	Filtered water or glycolised water	Filtered water or glycolised water
Water flow	800 l/h	800 l/h	500 l/h
Pressure drop	0.5 bar	0.5 bar	0.3 bar
Hydraulic connection	1/2" G	1/2" G	1/2" G
Electric characteristics			
Input voltage	1 x 230 V / 50-60 Hz*	2 x 400-440 V / 50-60 Hz	1 x 230 V / 50-60 Hz
Rated Intensity	0.71 A	0.4 A	0.30 A
Power consumption absorbed W10A35	160 W	170 W	65 W
Thermal protection recommended (fuse)	T2 A	T1 A	T2 A
Physical characteristics			
External dimensions (H x W x D)	1500 (59.06) x 450 (17.72) x 163 (6.42) mm (in.)	1500 (59.06) x 450 (17.72) x 163 (6.42) mm (in.)	270 (10.63) x 400 (15.75) x 542 (21.34) mm (in.)
Protection degree IP internal / external (according to IEC 60529)	IP55 / IP55	IP55 / IP55	IP54 / IP55
Noise level	69 dB (A)	69 dB (A)	58 dB (A)
Weight of unit	40 (88.18) kg (lbs.)	42 (92.59) kg (lbs.)	19 (41.89) kg (lbs.)
References			
Steel	NSYCEW6K	NSYCEW6K2P4	NSYCEW2K5R

Accessories



Characteristics	Air-to-air and air-to-water exchangers CE		Retrofit panel
	Steel	Stainless-steel	
Material			Panel that enable to mount a new ClimaSys CE units by replacement of old Schneider Electric cooling systems.
Color			Metal painted
Supply			RAL 7035 grey
References			1 unit
References Air- air exchangers			Old Schneider Electric cooling system
Side-mounted models	NSYCEA36	-	NSYCEA35W230VL NSYCEA35W230VLE
	NSYCEA50	-	-
	NSYCEA80	-	NSYCEA70W230VL
Air-to-water exchangers			
Side-mounted models	NSYCEW1K	NSYCEWX1K	-
	NSYCEW1K8	NSYCEWX1K8	-
	NSYCEW2K5	NSYCEWX2K5	NSYCEW2100W230VL
	NSYCEW3K5	-	NSYCEW3150W230VL
	NSYCEW4K5	-	-
	NSYCEW6K	-	-
	NSYCEW6K2P4	-	-
Top-mounted model	NSYCEW2K5R	-	-

Air-to-air exchangers, side-mounted models

NSYCEA22E

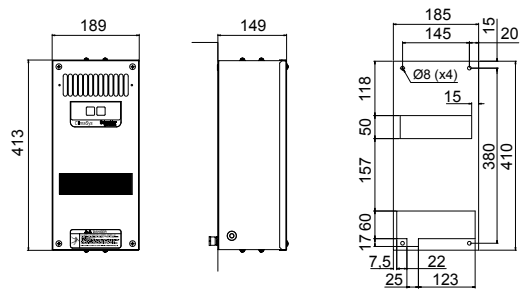

NSYCEA36 / NSYCEA50

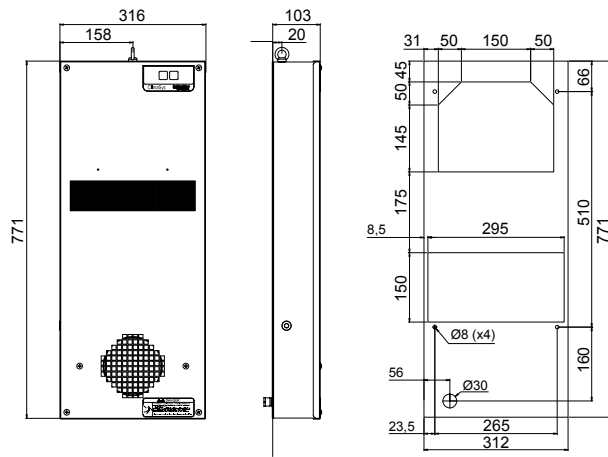

NSYCEA80

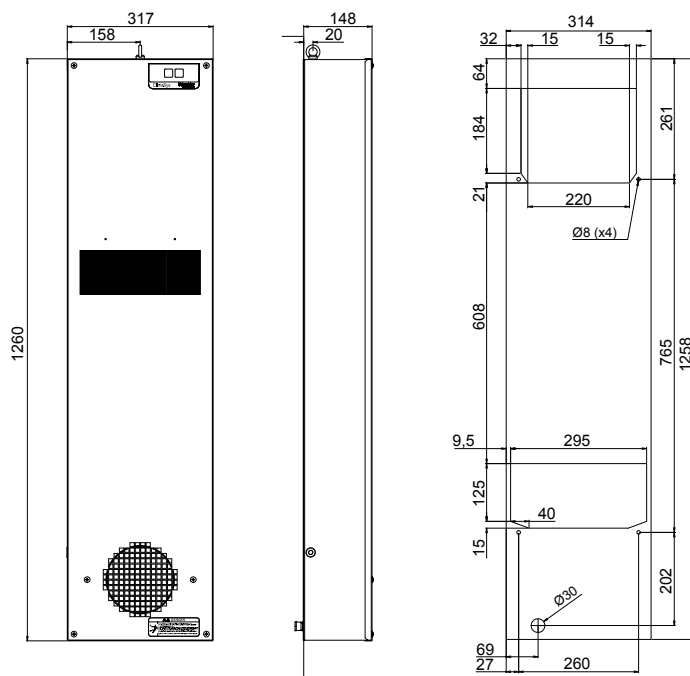

Air-to-water exchangers, side-mounted models

Performance curves

NSYCEW●●1K●●

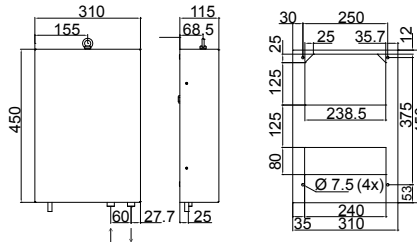
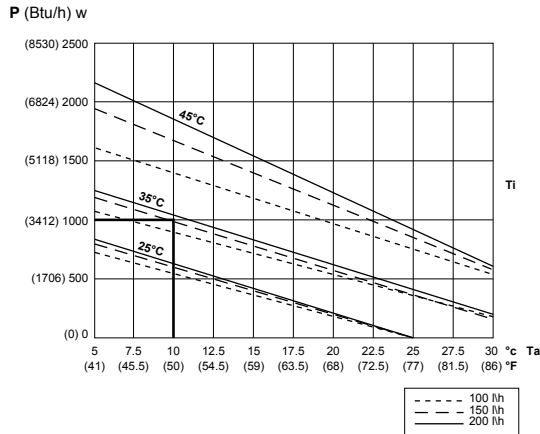

Performance curves

NSYCEW●●1K8●● – NSYCEW●●2K5●●

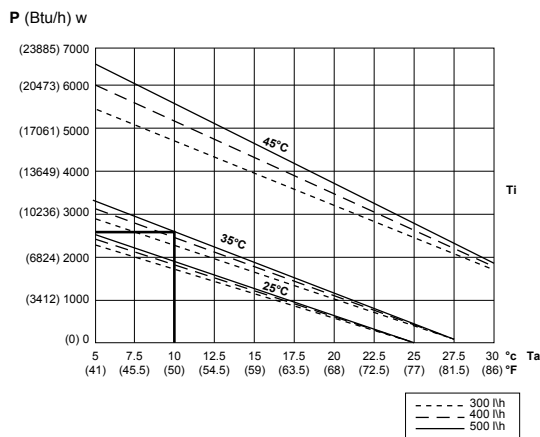
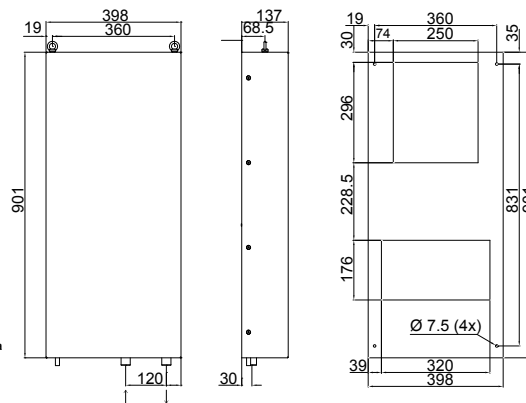
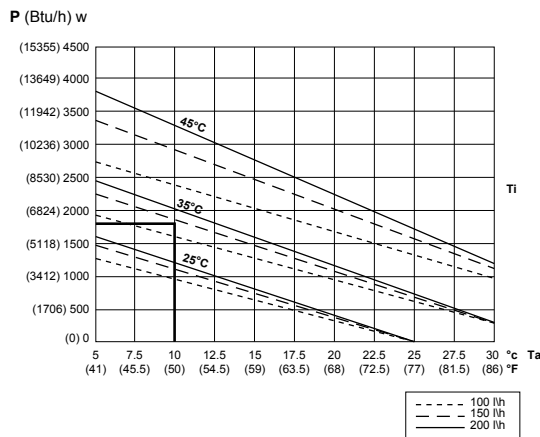

P = Cooling power
 Ta = Inlet water temperature
 Ti = Target internal temperature of the enclosure

Technical changes reserved. Information provided without guarantee. Images are for illustrative purposes only.

Air-to-water exchangers, side-mounted models

Performance curves

NSYCEW●●3K5●● - NSYCEW●●4K5●●

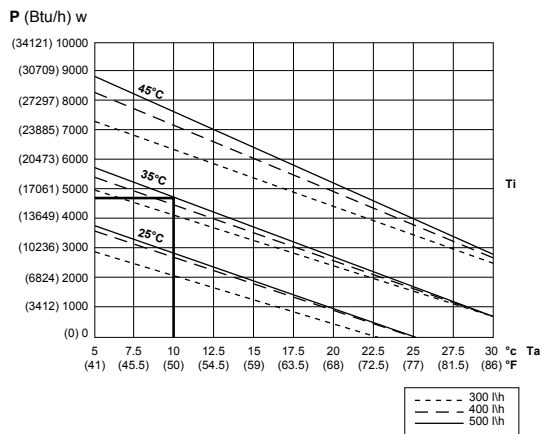
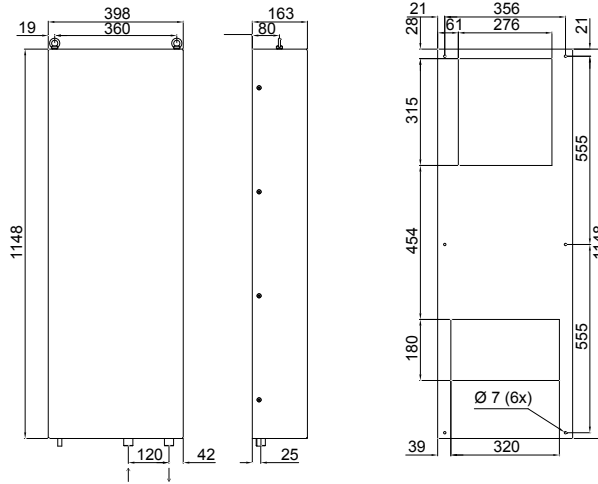
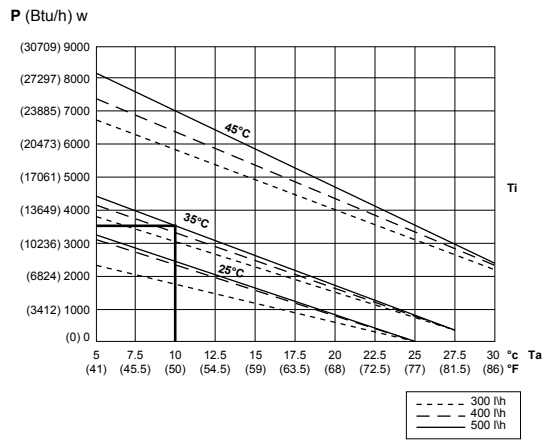

Performance curves

NSYCEW●●6K●●

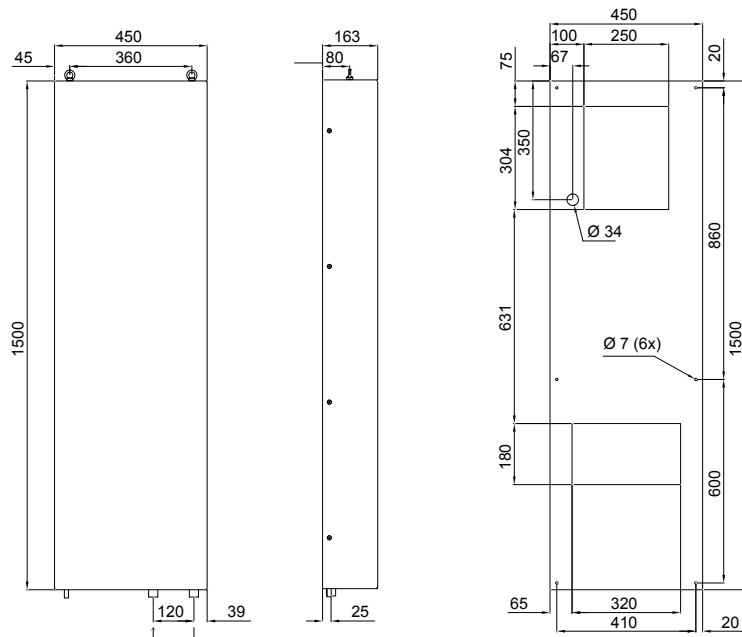
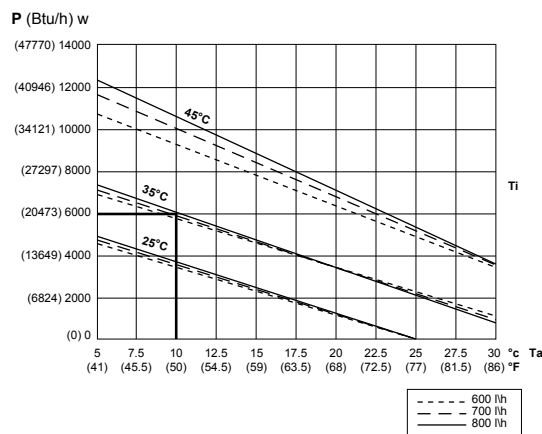

P = Cooling power
 Ta = Inlet water temperature
 Ti = Desired internal temperature of the enclosure

Technical changes reserved. Information provided without guarantee. Images are for illustrative purposes only.

Air-to-water exchangers, side-mounted models

Performance curves

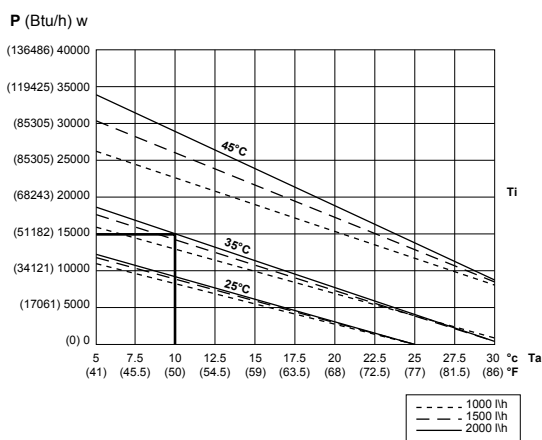
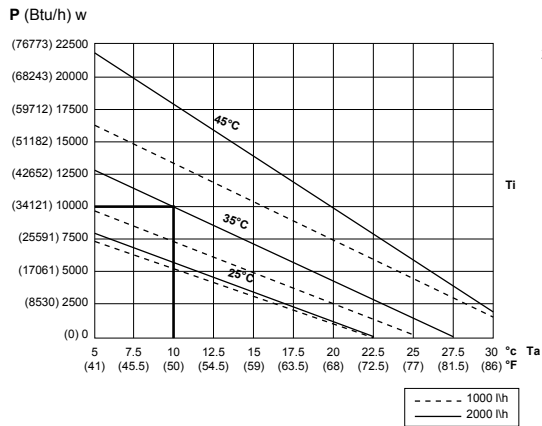

NSYCEW●●3K5●● – NSYCEW●●4K5●●

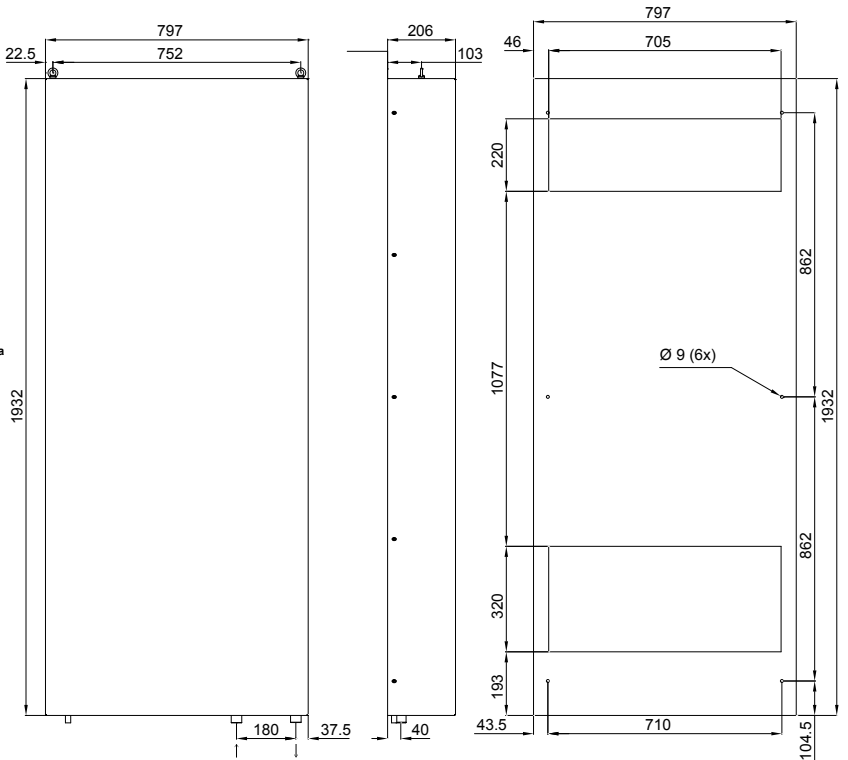

Performance curves

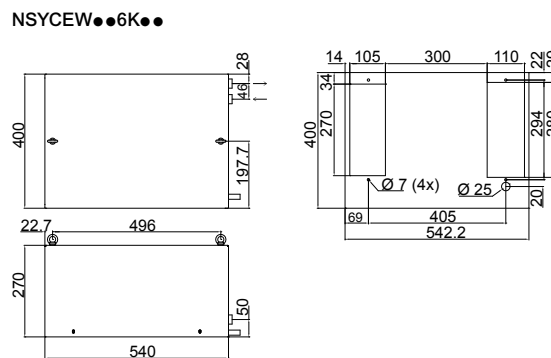
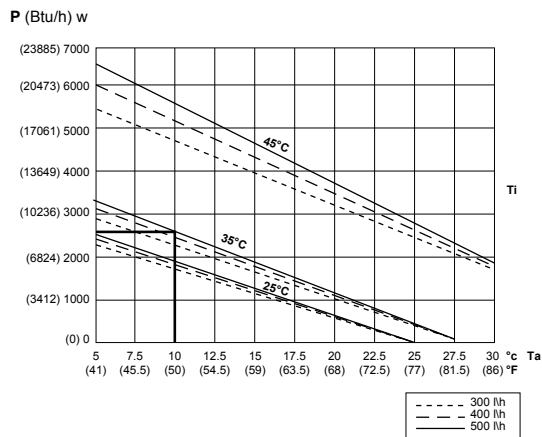

P = Cooling power
Ta = Inlet water temperature
Ti = Desired internal temperature of the enclosure

Technical changes reserved. Information provided without guarantee. Images are for illustrative purposes only.



Choose cooling units for harsh environments, where ambient temperatures can reach up to 55°C (131°F). The unit's integrated alarm system will signal you in the event of any operational anomaly.



Cooling units: For a high ambient temperature



Several mounting solutions

- Three models: Roof mode, floor model, side model. There is also a SLIM model which permits a space saving and perfect integration on the doors of control panels.



Large range of power levels

- Provide options for up to 15 kW of cooling power.

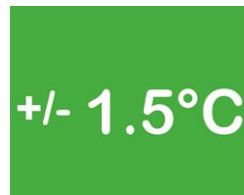

Precision of temperature control

- All ClimaSys cooling units are provided with a precise electronic control system by thermostat which gives them high cooling precision (+/- 15°C (59°F)).



Enhanced protection

- An internal grid of a new design helps protect the components and personnel during operation of the equipment while at the same time facilitating cleaning and maintenance.



Broad temperature range for outdoor enclosures

- The outdoor version can withstand extreme environments, with an operating temperature range of -20°C (-4°F) to +55°C (131°F).



Speed of access to information

- The new display offers fast access to the configuration parameters and information from the sensors located in the enclosure (does not apply to heavy-duty outdoor enclosures).



Certifications and declarations

- UL,
- CE,
- EAC



New materials

- Stainless-steel and painted galvanized steel for the outside dedicated to clean, hygienic environments such as food and beverage production plants.



Simplicity

- No tools needed to replace the filter. It just takes a few seconds.



Cooling units



Characteristics	Side-mounted models			
	<ul style="list-style-type: none"> Respect for the environment by using environmentally friendly gas R134a (HFC). Electronic thermostats in all models. Alarm signal for door contact included in all models. Eyebolts included. The external filter, not included as standard, is strongly recommended for harsh environments. Digital display. Evaporation condensation water unit integrated from 800 W to 15 kW. 			
Material	RAL 7035 grey painted zinc-coated steel or stainless-steel			
Certifications and declarations	<ul style="list-style-type: none"> CE declaration UL (only references ending with UL) EAC 			
Installation	Indoor			
Cooling characteristics				
Cooling power L35-L35 according to EN 14511	300 W (1024 Btu/h)	380 W (1297 Btu/h)	640 W (2184 Btu/h)	820 W (2798 Btu/h)
Cooling power L35-L50 according to EN 14511	150 W (512 Btu/h)	240 W (819 Btu/h)	470 W (1604 Btu/h)	680 W (2320 Btu/h)
Air flow of the internal circuit (enclosure)	280 (164.80) m ³ /h (ft ³ /min)	280 (164.80) m ³ /h (ft ³ /min)	330 (194.23) m ³ /h (ft ³ /min)	330 (194.23) m ³ /h (ft ³ /min)
Air flow of the external circuit (ambient)	280 (164.80) m ³ /h (ft ³ /min)	280 (164.80) m ³ /h (ft ³ /min)	570 (335.49) m ³ /h (ft ³ /min)	570 (335.49) m ³ /h (ft ³ /min)
Thermostat type	Electronic			
Temperature range internal circuit (enclosure)	+20°C (68°F) ... 46°C (115°F)	+20°C (68°F) ... 46°C (115°F)	+20°C (68°F) ... 46°C (115°F)	+20°C (68°F) ... 46°C (115°F)
Maximum outside temperature	+55°C (131°F)	+55°C (131°F) (+50°C (122°F))*	+55°C (131°F) (+50°C (122°F))*	+55°C (131°F) (+50°C (122°F))*
Temperature range external circuit (ambient)	+5°C (41°F) ... +55°C (131°F)*	+5°C (41°F) ... +55°C (131°F)* (+5°C (41°F) ... +50°C (122°F))*	+5°C (41°F) ... +55°C (131°F)* (+5°C (41°F) ... +50°C (122°F))*	+5°C (41°F) ... +55°C (131°F)* (+5°C (41°F) ... +50°C (122°F))*
Type of cooling gas	R134a	R134a	R134a	R134a
Cooling gas weight	0.13 (0.29) kg (lbs.)	0.16 (0.35) kg (lbs.)	0.23 (0.51) kg (lbs.)	0.23 (0.51) kg (lbs.)
Maximum pressure cooling circuit	25 bar	26 bar (28 bar)**	25 bar (28 bar)**	25 bar (28 bar)**
External filter	Optional, see page 485	Optional, see page 485	Optional, see page 485	Optional, see page 485
Electric characteristics				
Input voltage	1 x 230 V / 50-60 Hz	1 x 230 V / 50-60 Hz**	1 x 230 V / 50-60 Hz**	1 x 230 V / 50-60 Hz**
Starting / Rated Intensity	4.2 A / 1.5 A	6.0 A / 1.6 A	8.1 A / 2.1 A	10.8 A / 2.6 A
Power consumption absorbed L35-L35 according to EN 14511	270 W	280 W	400 W	440 W
Power consumption absorbed L35-L50 according to EN 14511	310 W	330 W	470 W	490 W
Energy efficiency ratio (EER) L35-L35	1.1	1.4	1.6	1.9
Thermal protection recommended (fuse)	T4 A	T4 A	T6 A	T6 A
Physical characteristics				
External dimensions (H x W x D)	340 (13.39) x 525 (20.67) x 135 (5.32) mm (in.)	460 (18.11) x 285 (11.22) x 180 (7.09) mm (in.)	606 (23.86) x 316 (12.44) x 212 (8.35) mm (in.)	783 (30.83) x 348 (13.70) x 215 (8.46) mm (in.)
Protection degree IP internal /external according to IEC 60529	IP55 / IP34	IP55 / IP34	IP55 / IP34	IP55 / IP34
Noise level	61 dB	60 dB	65 dB	65 dB
Weight of unit	17 (37.48) kg (lbs.)	17 (37.48) kg (lbs.)	21 (46.30) kg (lbs.)	27 (59.52) kg (lbs.)
References				
Steel	NSYCU300H	NSYCU400	NSYCU600	NSYCU800
Stainless-steel	-	NSYCUX400	NSYCUX600	NSYCUX800
Steel UL	-	NSYCU400UL	NSYCU600UL	NSYCU800UL
Stainless-steel UL	-	-	NSYCUX600UL	NSYCUX800UL

* 50°C (122°F) at 60 Hz.

** Certification UL only 60 Hz.



1000 W (3412 Btu/h)	1000 W (3412 Btu/h)	1250 W (4265 Btu/h)	1250 W (4265 Btu/h)	1600 W (5459 Btu/h)	1600 W (5459 Btu/h)	2000 W (6824 Btu/h)
790 W (2696 Btu/h)	790 W (2696 Btu/h)	910 W (3105 Btu/h)	910 W (3105 Btu/h)	1230 W (4197 Btu/h)	1230 W (4197 Btu/h)	1510 W (5152 Btu/h)
330 (194.23) m³/h (ft³/min)	330 (194.23) m³/h (ft³/min)	570 (335.49) m³/h (ft³/min)	570 (335.49) m³/h (ft³/min)	570 (335.49) m³/h (ft³/min)	570 (335.49) m³/h (ft³/min)	860 (506.18) m³/h (ft³/min)
570 (335.49) m³/h (ft³/min)	570 (335.49) m³/h (ft³/min)	860 (506.18) m³/h (ft³/min)	860 (506.18) m³/h (ft³/min)	1050 (618.01) m³/h (ft³/min)	1050 (618.01) m³/h (ft³/min)	1050 (618.01) m³/h (ft³/min)
Electronic	Electronic	Electronic	Electronic	Electronic	Electronic	Electronic
+20°C (68°F) ... 46°C (115°F)	+20°C (68°F) ... 46°C (115°F)	+20°C (68°F) ... 46°C (115°F)	+20°C (68°F) ... 46°C (115°F)	+20°C (68°F) ... 46°C (115°F)	+20°C (68°F) ... 46°C (115°F)	+20°C (68°F) ... 46°C (115°F)
+55°C (131°F) (+50°C (122°F))*	+55°C (131°F) (+50°C (122°F))*	+55°C (131°F) (+50°C (122°F))*	+55°C (131°F)	+55°C (131°F) (+50°C (122°F))*	+50°C (122°F)*	+55°C (131°F) (+50°C (122°F))*
+5°C (41°F) ... +55°C (131°F)*	+5°C (41°F) ... +50°C (122°F)	+5°C (41°F) ... +55°C (131°F)*	+5°C (41°F) ... +50°C (122°F)	+5°C (41°F) ... +55°C (131°F)*	+5°C (41°F) ... +50°C (122°F)	+5°C (41°F) ... +55°C (131°F)*
(+5°C (41°F) ... +50°C (122°F))*	(+5°C (41°F) ... +50°C (122°F))*	(+5°C (41°F) ... +50°C (122°F))*		(+5°C (41°F) ... +50°C (122°F))*		(+5°C (41°F) ... +50°C (122°F))*
R134a	R134a	R134a	R134a	R134a	R134a	R134a
0.23 (0.51) kg (lbs.)	0.23 (0.51) kg (lbs.)	0.38 (0.84) kg (lbs.)	0.38 (0.84) kg (lbs.)	0.45 (0.99) kg (lbs.)	0.45 (0.99) kg (lbs.)	0.54 (1.19) kg (lbs.)
25 bar (28 bar)**	25 bar (28 bar)**	25 bar (28 bar)**	25 bar	25 bar (28 bar)**	25 bar (28 bar)**	25 bar (28 bar)**
Optional, see page 485	Optional, see page 485	Optional, see page 485	Optional, see page 485	Optional, see page 485	Optional, see page 485	Optional, see page 485
1 x 230 V / 50-60 Hz**	2 x 400-440 V / 50-60 Hz	1 x 230 V / 50-60 Hz**	2 x 400-440 V / 50-60 Hz	1 x 230 V / 50-60 Hz**	2 x 400-440 V / 50-60 Hz	1 x 230 V / 50-60 Hz**
10.5 A / 3 A	8 A / 2 A	11 A / 3.8 A	8.5 A / 2.8 A	18 A / 5.4 A	11 A / 2.9 A	24 A / 6.5 A
570 W	590 W	650 W	650 W	850 W	840 W	1080 W
650 W	670 W	760 W	770 W	970 W	960 W	1290 W
1.8	1.7	1.9	1.9	1.9	1.9	1.9
T6 A	T4 A	T6 A	T4 A	T10 A	T6 A	T10 A
783 (30.83) x 348 (13.70) x 215 (8.46) mm (in.)	783 (30.83) x 348 (13.70) x 215 (8.46) (+ 58 (2.28)) mm (in.)	999 (39.33) x 405 (15.94) x 237 (9.33) mm (in.)	999 (39.33) x 405 (15.94) x 237 (9.33) mm (in.)	999 (39.33) x 405 (15.94) x 237 (9.33) mm (in.)	999 (39.33) x 405 (15.94) x 237 (9.33) mm (in.)	999 (39.33) x 405 (15.94) x 237 (9.33) mm (in.)
IP55 / IP34	IP55 / IP34	IP55 / IP34	IP55 / IP34	IP55 / IP34	IP55 / IP34	IP55 / IP34
65 dB	65 dB	65 dB	65 dB	65 dB	65 dB	65 dB
28 (61.73) kg (lbs.)	29 (63.93) kg (lbs.)	38 (83.78) kg (lbs.)	40 (88.18) kg (lbs.)	40 (88.18) kg (lbs.)	42 (92.59) kg (lbs.)	52 (114.64) kg (lbs.)
NSYCU1K	NSYCU1K2P4	NSYCU1K2	NSYCU1K22P4	NSYCU1K6	NSYCU1K62P4	NSYCU2K
NSYCU1KUL	NSYCU1K2P4UL	NSYCU1K2UL	-	NSYCU1K6UL	NSYCU1K62P4UL	NSYCU2KUL
NSYCU1KUL	NSYCU1K2P4UL	NSYCU1K2UL	-	NSYCU1K6UL	NSYCU1K62P4UL	NSYCU2KUL

Cooling units



Characteristics		Side-mounted models
		Alarm signal for door contact included in all models. Eyebolts included. The external filter, not included as standard, is strongly recommended for harsh environments.
Material		RAL 7035 grey painted zinc-coated steel or stainless-steel
Certifications and declarations		CE declaration UL (only references ending with UL) EAC
Installation		Indoor
Cooling characteristics		
Cooling power L35-L35 according to EN 14511		2000 W (6824 Btu/h)
Cooling power L35-L50 according to EN 14511		1510 W (5152 Btu/h)
Air flow of the internal circuit (enclosure)		860 (506.18) m ³ /h (ft ³ /min)
Air flow of the external circuit (ambient)		1050 (618.01) m ³ /h (ft ³ /min)
Thermostat type		Electronic
Temperature range internal circuit (enclosure)		+20°C (68°F) ... +46°C (115°F) (+45°C (113°F))*
Maximum outside temperature		+50°C (122°F) (+45°C (113°F))
Temperature range external circuit (ambient)		+5°C (41°F) ... +50°C (122°F) (+5°C (41°F) ... +45°C (113°F))*
Type of cooling gas		R134a
Cooling gas weight		0.59 (1.30) kg (lbs.)
Maximum pressure cooling circuit		25 bar (28 bar)*
External filter		Optional, see page 485
Electric characteristics		
Input voltage		3 x 400 V / 50-60 Hz 3 x 460 V / 60 Hz*
Starting / Rated Intensity		10 A / 2.5 A
Power consumption absorbed L35-L35 according to EN 14511		970 W
Power consumption absorbed L35-L50 according to EN 14511		1150 W
Energy efficiency ratio (EER) L35-L35		2.1
Thermal protection recommended (fuse)		T6 A
Physical characteristics		
External dimensions (H x W x D)		999 (39.33) x 405 (15.94) x 237 (9.33) mm (in.)
Protection degree IP internal /external according to IEC 60529		IP55 / IP34
Noise level		65 dB
Weight of unit		54 (119.05) kg (lbs.)
References		
Steel		NSYCU2K3P4
Stainless-steel		NSYCUX2K3P4
Steel UL		NSYCU2K3P4UL
Stainless-steel UL		NSYCUX2K3P4UL

* Certification UL only 60 Hz..



Floor-standing models

2900 W (9895 Btu/h)	3850 W (13137 Btu/h)	5800 W (19790 Btu/h)
2250 W (7677 Btu/h)	2870 W (9793 Btu/h)	4350 W (14843 Btu/h)
1450 (853.44) m³/h (ft³/min)	1450 (853.44) m³/h (ft³/min)	1450 (853.44) m³/h (ft³/min)
1450 (853.44) m³/h (ft³/min)	1450 (853.44) m³/h (ft³/min)	2900 (1706.88) m³/h (ft³/min)
Electronic	Electronic	Electronic
+20°C (68°F) ... +46°C (115°F) (+45°C (113°F))*	+20°C (68°F) ... +46°C (115°F) (+45°C (113°F))*	+20°C (68°F) ... +46°C (115°F)
+50°C (122°F) (+45°C (113°F))	+50°C (122°F) (+45°C (113°F))	+50°C (122°F)
+5°C (41°F) ... +50°C (122°F)	+5°C (41°F) ... +50°C (122°F)	+10°C (50°F) ... +50°C (122°F)
(+5°C (41°F) ... +45°C (113°F))*	(+5°C (41°F) ... +45°C (113°F))*	
R134a	R134a	R407c
0.84 (1.85) kg (lbs.)	1.14 (2.51) kg (lbs.)	1.8 (3.97) kg (lbs.)
25 bar (28 bar)*	25 bar (28 bar)*	27 bar
Optional, see page 485	Optional, see page 485	Polyurethane filter standard
3 x 400 V / 50-60 Hz	3 x 400 V / 50-60 Hz	3 x 400 V / 50 Hz
3 x 460 V / 60 Hz*	3 x 460 V / 60 Hz*	
14 A / 2.6 A	18 A / 3.6 A	21.7 A / 5.9 A
1220 W	1780 W	2340 W
1440 W	2050 W	3880 W
2.4	2.2	2.5
T6 A	T8 A	T8 A
1270 (50.00) x 500 (19.68) x 336 (13.23) mm (in.)	1270 (50.00) x 500 (19.68) x 336 (13.23) mm (in.)	2000 (78.74) x 600 (23.62) x 380 (14.96) mm (in.)
IP55 / IP34	IP55 / IP34	IP54 / IP34
70 dB	70 dB	72 dB
84 (185.19) kg (lbs.)	85 (187.39) kg (lbs.)	150 (330.69) kg (lbs.)
NSYCU3K3P4	NSYCU4K3P4	NSYCU6K3P4
NSYCUX3K3P4	NSYCUX4K3P4	-
NSYCU3K3P4UL	NSYCU4K3P4UL	-
NSYCUX3K3P4UL	NSYCUX4K3P4UL	-

Cooling units



Characteristics	Roof-mounting models		
	<ul style="list-style-type: none"> Respect for the environment by using environmentally friendly gas R134a (HFC). Integrated water condensation exit system. Alarm signal for door contact included in all models. Eyebolts included. The external filter, not included as standard, is strongly recommended for harsh environments. 		
Material	RAL 7035 grey painted zinc-coated steel or stainless-steel.		
Certifications and declarations	<ul style="list-style-type: none"> CE declaration UL (only references ending with UL) EAC 		
Installation	Indoor		
Cooling characteristics			
Cooling power L35-L35 according to EN 14511	410 W (1399 Btu/h)	820 W (2798 Btu/h)	1150 W (3924 Btu/h)
Cooling power L35-L50 according to EN 14511	240 W (819 Btu/h)	680 W (2320 Btu/h)	900 W (3071 Btu/h)
Air flow of the internal circuit (enclosure)	235 (138.32) m ³ /h (ft ³ /min)	570 (335.49) m ³ /h (ft ³ /min)	570 (335.49) m ³ /h (ft ³ /min)
Air flow of the external circuit (ambient)	330 (194.23) m ³ /h (ft ³ /min)	860 (506.18) m ³ /h (ft ³ /min)	1010 (594.46) m ³ /h (ft ³ /min)
Thermostat type	Electronic	Electronic	Electronic
Temperature range internal circuit (enclosure)	+20°C (68°F) ... +46°C (115°F)	+20°C (68°F) ... +46°C (115°F)	+20°C (68°F) ... +46°C (115°F)
Maximum outside temperature	+55°C (131°F) (+50°C (122°F))*	+55°C (131°F) (+50°C (122°F))*	+55°C (131°F) (+50°C (122°F))*
Temperature range external circuit (ambient)	+5°C (41°F) ... +55°C (131°F)* (+5°C (41°F) ... +50°C (122°F))*	+5°C (41°F) ... +55°C (131°F)* (+5°C (41°F) ... +50°C (122°F))*	+5°C (41°F) ... +55°C (131°F)* (+5°C (41°F) ... +50°C (122°F))*
Type of cooling gas	R134a	R134a	R134a
Cooling gas weight	0.17 (0.37) kg (lbs.)	0.31 (0.68) kg (lbs.)	0.63 (1.39) kg (lbs.)
Maximum pressure cooling circuit	28 bar	25 bar (28 bar)**	25 bar (28 bar)**
External filter	Optional, see page 485	Optional, see page 485	Optional, see page 485
Electric characteristics			
Input voltage	1 x 230 V / 50-60 Hz**	1 x 230 V / 50-60 Hz**	1 x 230 V / 50-60 Hz**
Starting / Rated Intensity	4 A / 1.5 A	12 A / 2.9 A	11 A / 3.2 A
Power consumption absorbed L35-L35 according to EN 14511	230 W	510 W	550 W
Power consumption absorbed L35-L50 according to EN 14511	290 W	560 W	660 W
Energy efficiency ratio (EER) L35-L35	1.8	1.6	2.1
Thermal protection recommended (fuse)	T4 A	T6 A	T6 A
Physical characteristics			
External dimensions (H x W x D)	264 (10.39) x 486 (19.13) x 259 (10.20) mm (in.)	340 (13.39) x 600 (23.62) x 340 (13.39) mm (in.)	415 (16.34) x 567 (22.32) x 401 (15.79) mm (in.)
Protection degree IP internal /external according to IEC 60529	IP54 / IP34	IP54 / IP34	IP54 / IP34
Noise level	65 dB	65 dB	65 dB
Weight of unit	18 (39.68) kg (lbs.)	23 (50.71) kg (lbs.)	40 (88.18) kg (lbs.)
References			
Steel	NSYCU400R	NSYCU800R	NSYCU1K2R
Stainless-steel	NSYCUX400R	NSYCUX800R	NSYCUX1K2R
Steel UL	NSYCU400RUL	NSYCU800RUL	NSYCU1K2RUL

* 50°C (122°F) at 60 Hz.

** Certification UL only 60 Hz.

*** For cooling units greater than 65 (143.30) kg (lbs.) we recommend to place universal cross-rails **NSYSUCR4060** or **NSYSUCR4080**.

Device for dissipating condensation water (external installation)

- Device allowing the evacuation of condensation water from the internal battery (evaporator).
- Supplied with stainless-steel support.
- Power supply:

Operating voltage ±10%				
Voltage	Starting current	Thermal protection recommended	Evaporation capacity	Resistance type
230 V~	2.9 A	T 3 A	200 cl/h	PTC
115 V~	5.8 A	T 6 A	200 cl/h	PTC

Heat sink

NSYCUAD

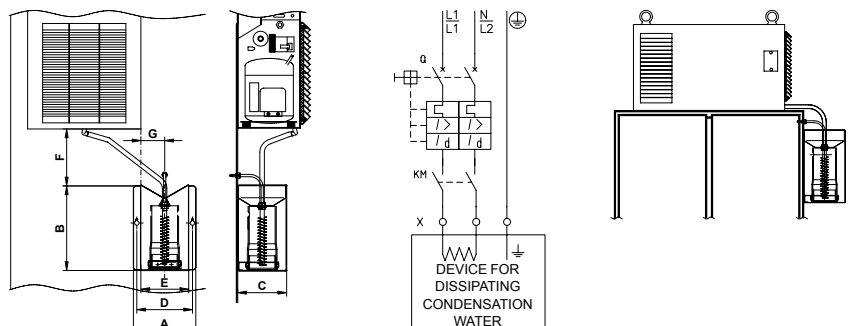

Technical changes reserved. Information provided without guarantee. Images are for illustrative purposes only.



1550 W (5289 Btu/h)	2050 W (6995 Btu/h)	2050 W (6995 Btu/h)	2900 W (9895 Btu/h)	3850 W (13137 Btu/h)
1200 W (4095 Btu/h)	1560 W (5323 Btu/h)	1560 W (5323 Btu/h)	2250 W (7677 Btu/h)	2870 W (9793 Btu/h)
860 (506.18) m ³ /h (ft ³ /min)	1050 (618.01) m ³ /h (ft ³ /min)	1050 (618.01) m ³ /h (ft ³ /min)	860 (506.18) m ³ /h (ft ³ /min)	1450 (853.44) m ³ /h (ft ³ /min)
1820 (1071.21) m ³ /h (ft ³ /min)	1820 (1071.21) m ³ /h (ft ³ /min)	1820 (1071.21) m ³ /h (ft ³ /min)	3410 (2007.05) m ³ /h (ft ³ /min)	3410 (2007.05) m ³ /h (ft ³ /min)
Electronic	Electronic	Electronic	Electronic	Electronic
+20°C (68°F) ... +46°C (115°F)	+20°C (68°F) ... +46°C (115°F)	+20°C (68°F) ... +46°C (115°F)	+20°C (68°F) ... +46°C (115°F)	+20°C (68°F) ... +46°C (115°F)
+55°C (131°F)	+55°C (131°F) (+50°C (122°F))**	+50°C (122°F) (+45°C (113°F))**	+50°C (122°F) (+45°C (113°F))**	+50°C (122°F) (+45°C (113°F))**
+5°C (41°F) ... +55°C (131°F)* (+5°C (41°F) ... +50°C (122°F))*	+5°C (41°F) ... +55°C (131°F)*	+5°C (41°F) ... +50°C (122°F) (+5°C (41°F) ... +45°C (113°F))**	+5°C (41°F) ... +50°C (122°F) (+5°C (41°F) ... +45°C (113°F))**	+5°C (41°F) ... +50°C (122°F) (+5°C (41°F) ... +45°C (113°F))**
R134a	R134a	R134a	R134a	R134a
0.54 (1.19) kg (lbs.)	0.55 (1.21) kg (lbs.)	0.55 (1.21) kg (lbs.)	1.20 (2.65) kg (lbs.)	1.60 (3.53) kg (lbs.)
25 bar (28 bar)**	25 bar	25 bar (28 bar)**	25 bar (28 bar)**	25 bar (28 bar)**
Optional, see page 485	Optional, see page 485	Optional, see page 485	Optional, see page 485	Optional, see page 485
1 x 230 V / 50-60 Hz**	1 x 230 V / 50-60 Hz	3 x 400 V / 50-60 Hz 3 x 460 V / 60 Hz*	3 x 400 V / 50-60 Hz 3 x 460 V / 60 Hz*	3 x 400 V / 50-60 Hz 3 x 460 V / 60 Hz*
18 A / 4.5 A	24 A / 6 A	10 A / 1.9 A	15.7 A / 2.5 A	17 A / 3.6 A
810 W	1150 W	990 W	1210 W	1790 W
930 W	1250 W	1190 W	1450 W	2010 W
1.9	1.8	2.1	2.4	2.2
T10 A	T10 A	T6 A	T6 A	T6 A
415 (16.34) x 567 (22.32) x 401 (15.79) mm (in.)	415 (16.34) x 567 (22.32) x 401 (15.79) mm (in.)	415 (16.34) x 567 (22.32) x 401 (15.79) mm (in.)	496 (19.53) x 797 (31.38) x 4 92 (19.37) mm (in.)	496 (19.53) x 797 (31.38) x 492 (19.37) mm (in.)
IP54 / IP34	IP54 / IP34	IP54 / IP34	IP54 / IP34	IP54 / IP34
65 dB	65 dB	65 dB	75 dB	75 dB
44 (97.00) kg (lbs.)	50 (110.23) kg (lbs.)	52 (114.64) kg (lbs.)	83 (182.98) kg (lbs.) ***	86 (189.60) kg (lbs.) ***
NSYCU1K5R NSYCU1K5R NSYCU1K5RUL	NSYCU2KR NSYCU2KR -	NSYCU2K3P4R NSYCU2K3P4R NSYCU2K3P4RUL	NSYCU3K3P4R NSYCU3K3P4R NSYCU3K3P4RUL	NSYCU4K3P4R NSYCU4K3P4R NSYCU4K3P4RUL

Outdoor Heavy-Duty cooling units



Characteristics		Side-mounted models		
		<ul style="list-style-type: none"> Respect for the environment by using environmentally friendly gas R134a (HFC). Mechanical thermostats in all models. Eyebolts included. The external filter, not included as standard. The metal filter is strongly recommended. Metalic canopy as standard. Anti-corrosive protection (class C3H). Inside components, including the condenser, coated with anti-corrosive protection. 		
Material		RAL 7035 grey painted zinc-coated steel		
Certifications and declarations		<ul style="list-style-type: none"> CE declaration EAC 		
Installation		Indoor or outdoor		
Cooling characteristics				
Cooling power L35-L35 according to EN 14511		380 W (1297 Btu/h)	640 W (2184 Btu/h)	820 W (2798 Btu/h)
Cooling power L35-L50 according to EN 14511		240 W (819 Btu/h)	470 W (1604 Btu/h)	680 W (2320 Btu/h)
Air flow of the internal circuit (enclosure)		280 (164.80) m ³ /h (ft ³ /min)	330 (194.23) m ³ /h (ft ³ /min)	330 (194.23) m ³ /h (ft ³ /min)
Air flow of the external circuit (ambient)		280 (164.80) m ³ /h (ft ³ /min)	570 (335.49) m ³ /h (ft ³ /min)	570 (335.49) m ³ /h (ft ³ /min)
Thermostat type		Mechanic	Mechanic	Mechanic
Temperature range internal circuit (enclosure)		+20°C (68°F) ... +50°C (122°F)	+20°C (68°F) ... +50°C (122°F)	+20°C (68°F) ... +50°C (122°F)
Maximum outside temperature		+55°C (131°F) (131°F)	+55°C (131°F) (131°F)	+55°C (131°F) (131°F)
Temperature range external circuit (ambient)		-20°C (-4°F) ... +55°C (131°F) (131°F)	-20°C (-4°F) ... +55°C (131°F) (131°F)	-20°C (-4°F) ... +55°C (131°F) (131°F)
Type of cooling gas		R134a	R134a	R134a
Cooling gas weight		0.16 (0.35) kg (lbs.)	0.26 (0.57) kg (lbs.)	0.28 (0.62) kg (lbs.)
Maximum pressure cooling circuit		26 bar	25 bar	25 bar
External filter		Optional, see metallic filter on page 485	Optional, see metallic filter on page 485	Optional, see metallic filter on page 485
Electric characteristics				
Input voltage		1 x 230 V / 50-60 Hz	1 x 230 V / 50-60 Hz	1 x 230 V / 50-60 Hz
Starting / Rated Intensity		6.0 A / 1.6 A	8.1 A / 2.1 A	10.8 A / 2.6 A
Power consumption absorbed L35-L35 according to EN 14511		280 W	400 W	440 W
Power consumption absorbed L35-L50 according to EN 14511		330 W	470 W	490 W
Energy efficiency ratio (EER) L35-L35		1.4	1.6	1.9
Thermal protection recommended (fuse)		T4 A	T6 A	T6 A
Physical characteristics				
External dimensions (H x W x D)		573 (22.56) x 300 (11.81) x 205 (8.07) mm (in.)	718 (28.27) x 331 (13.03) x 235 (9.25) mm (in.)	875 (34.45) x 363 (14.29) x 239 (9.41) mm (in.)
Protection degree IP internal /external according to IEC 60529		IP55 / IP34	IP55 / IP34	IP55 / IP34
Noise level		60 dB	65 dB	65 dB
Weight of unit		17 (37.48) kg (lbs.)	21 (46.30) kg (lbs.)	27 (59.52) kg (lbs.)
References		NSYCUHD400	NSYCUHD600	NSYCUHD800



1000 W (3412 Btu/h)	1000 W (3412 Btu/h)	1600 W (5459 Btu/h)	1600 W (5459 Btu/h)	2000 W (6824 Btu/h)	2900 W (9895 Btu/h)	3850 W (13137 Btu/h)
790 W (2696 Btu/h)	790 W (2696 Btu/h)	1230 W (4197 Btu/h)	1230 W (4197 Btu/h)	1510 W (5152 Btu/h)	2250 W (7677 Btu/h)	2870 W (9793 Btu/h)
330 (194.23) m³/h (ft³/min)	330 (194.23) m³/h (ft³/min)	570 (335.49) m³/h (ft³/min)	570 (335.49) m³/h (ft³/min)	860 (506.18) m³/h (ft³/min)	1450 (853.44) m³/h (ft³/min)	1450 (853.44) m³/h (ft³/min)
570 (335.49) m³/h (ft³/min)	570 (335.49) m³/h (ft³/min)	1050 (618.01) m³/h (ft³/min)	1050 (618.01) m³/h (ft³/min)	1050 (618.01) m³/h (ft³/min)	1450 (853.44) m³/h (ft³/min)	1450 (853.44) m³/h (ft³/min)
Mechanic	Mechanic	Mechanic	Mechanic	Mechanic	Mechanic	Mechanic
+20°C (68°F) ... +50°C (122°F)	+20°C (68°F) ... +50°C (122°F)	+20°C (68°F) ... +50°C (122°F)	+20°C (68°F) ... +50°C (122°F)	+20°C (68°F) ... +50°C (122°F)	+20°C (68°F) ... +50°C (122°F)	+20°C (68°F) ... +50°C (122°F)
+55°C (131°F) (131°F)	+55°C (131°F) (131°F)	+55°C (131°F) (131°F)	+55°C (131°F) (131°F)	+55°C (131°F) (131°F)	+55°C (131°F) (131°F)	+55°C (131°F) (131°F)
-20°C (-4°F) ... +55°C (131°F) (131°F)	-20°C (-4°F) ... +50°C (122°F)	-20°C (-4°F) ... +55°C (131°F) (131°F)	-20°C (-4°F) ... +50°C (122°F)	-20°C (-4°F) ... +55°C (131°F) (131°F)	-20°C (-4°F) ... +50°C (122°F)	-20°C (-4°F) ... +50°C (122°F)
R134a	R134a	R134a	R134a	R134a	R134a	R134a
0.27 (0.60) kg (lbs.)	0.27 (0.60) kg (lbs.)	0.46 (1.01) kg (lbs.)	0.46 (1.01) kg (lbs.)	0.65 (1.43) kg (lbs.)	0.84 (1.85) kg (lbs.)	1.14 (2.51) kg (lbs.)
25 bar	25 bar	25 bar	25 bar	25 bar	25 bar	25 bar
Optional, see metallic filter on page 485	Optional, see metallic filter on page 485	Optional, see metallic filter on page 485	Optional, see metallic filter on page 485	Optional, see metallic filter on page 485	Optional, see metallic filter on page 485	Optional, see metallic filter on page 485
1 x 230 V / 50-60 Hz	2 x 400-440 V / 50-60 Hz	1 x 230 V / 50-60 Hz	2 x 400-440 V / 50-60 Hz	3 x 400 V / 50-60 Hz	3 x 400 V / 50-60 Hz	3 x 400 V / 50-60 Hz
10.5 A / 3 A	8 A / 2 A	18 A / 5.3 A	11 A / 2.9 A	10 A / 2.5 A	14 A / 2.6 A	18 A / 3.6 A
570 W	590 W	820 W	840 W	970 W	1220 W	1780 W
650 W	670 W	940 W	960 W	1150 W	1440 W	2050 W
1.8	1.7	2.0	1.9	2.1	2.4	2.2
T6 A	T4 A	T10 A	T6 A	T6 A	T6 A	T8 A
895 (35.24) x 363 (14.29) x 239 (9.41) mm (in.)	895 (35.24) x 363 (14.29) x 239 (9.41) (+58 (2.28)) mm (in.)	1009 (39.72) x 415 (16.34) x 261 (10.28) mm (in.)	1009 (39.72) x 415 (16.34) x 261 (10.28) mm (in.)	1009 (39.72) x 415 (16.34) x 261 (10.28) mm (in.)	1416 (55.75) x 512 (20.16) x 365 (14.37) mm (in.)	1416 (55.75) x 512 (20.16) x 365 (14.37) mm (in.)
IP55 / IP34	IP55 / IP34	IP55 / IP34	IP55 / IP34	IP55 / IP34	IP55 / IP34	IP55 / IP34
65 dB	65 dB	65 dB	65 dB	65 dB	70 dB	70 dB
28 (61.73) kg (lbs.)	29 (63.93) kg (lbs.)	40 (88.18) kg (lbs.)	42 (92.59) kg (lbs.)	54 (119.05) kg (lbs.)	84 (185.19) kg (lbs.)	85 (187.39) kg (lbs.)
NSYCUHD1K	NSYCUHD1K2P4	NSYCUHD1K6	NSYCUHD1K62P4	NSYCUHD2K3P4	NSYCUHD3K3P4	NSYCUHD4K3P4

Technical changes reserved. Information provided without guarantee. Images are for illustrative purposes only.

Slim cooling units



Characteristics		Side-mounted models			
		<ul style="list-style-type: none"> Respect for the environment by using environmentally friendly gas R134a (HFC). Electronical thermostat included. 3 mounting positions (surface, half-flush and flush). Alarm Signal for contact door. Eyebolts included. 			
Material		RAL 7035 grey painted zinc-coated steel or stainless-steel			
Certifications and declarations		<ul style="list-style-type: none"> CE declaration UL EAC 			
Installation		<ul style="list-style-type: none"> Indoor There is one unique cut-out for all mounting positions and all slim models 			
Cooling characteristics					
Cooling power L35-L35 according to EN 14511	1100 W (3753 Btu/h)	1100 W (3753 Btu/h)	1500 W (5118 Btu/h)	1500 W (5118 Btu/h)	
Cooling power L35-L50 according to EN 14511	860 W (2934 Btu/h)	860 W (2934 Btu/h)	1150 W (3924 Btu/h)	1150 W (3924 Btu/h)	
Air flow of the internal circuit (enclosure)	860 (506.18) m ³ /h (ft ³ /min)	860 (506.18) m ³ /h (ft ³ /min)	860 (506.18) m ³ /h (ft ³ /min)	860 (506.18) m ³ /h (ft ³ /min)	
Air flow of the external circuit (ambient)	860 (506.18) m ³ /h (ft ³ /min)	860 (506.18) m ³ /h (ft ³ /min)	860 (506.18) m ³ /h (ft ³ /min)	860 (506.18) m ³ /h (ft ³ /min)	
Thermostat type	Electronic	Electronic	Electronic	Electronic	
Temperature range internal circuit (enclosure)	+20°C (68°F) ... +46°C (115°F)	+20°C (68°F) ... +46°C (115°F)	+20°C (68°F) ... +46°C (115°F)	+20°C (68°F) ... +46°C (115°F)	
Maximum outside temperature	+50°C (122°F)	+50°C (122°F)	+50°C (122°F)	+50°C (122°F)	
Temperature range external circuit (ambient)	+5°C (41°F) ... +50°C (122°F)	+5°C (41°F) ... +50°C (122°F)	+5°C (41°F) ... +50°C (122°F)	+5°C (41°F) ... +50°C (122°F)	
Type of cooling gas	R134a	R134a	R134a	R134a	
Cooling gas weight	0.5 (1.10) kg (lbs.)	0.5 (1.10) kg (lbs.)	0.46 (1.01) kg (lbs.)	0.46 (1.01) kg (lbs.)	
Maximum pressure cooling circuit	28 bar	28 bar	28 bar	28 bar	
External circuit filter	Optional, see page 485	Optional, see page 485	Optional, see page 485	Optional, see page 485	
Electric characteristics					
Input voltage	1 x 230 V / 50-60 Hz*	2 x 400-460 V / 50-60 Hz*	1 x 230 V / 50-60 Hz*	2 x 400-460 V / 50-60 Hz*	
Starting / Rated Intensity	11 A / 4.8 A	8.5 A / 2.7 A	18 A / 5.7 A	11 A / 3.2 A	
Power consumption absorbed L35-L35 according to EN 14511	660 W	660 W	840 W	840 W	
Power consumption absorbed L35-L50 according to EN 14511	790 W	790 W	970 W	970 W	
Energy efficiency ratio (EER) L35-L35	1.7	1.7	1.8	1.8	
Thermal protection recommended (fuse)	T6 A	T4 A	T10 A	T6 A	
Physical characteristics					
External dimensions (H x W x D)	1696 (66.77) x 495 (19.49) x 195 (7.68) mm (in.)	1696 (66.77) x 495 (19.49) x 195 (7.68) mm (in.)	1696 (66.77) x 495 (19.49) x 195 (7.68) mm (in.)	1696 (66.77) x 495 (19.49) x 195 (7.68) mm (in.)	
Protection degree IP internal /external according to IEC 60529	IP55 / IP34	IP55 / IP34	IP55 / IP34	IP55 / IP34	
Noise level	64 dB	64 dB	66 dB	66 dB	
Weight of unit	50 (110.23) kg (lbs.)	52 (114.64) kg (lbs.)	55 (121.25) kg (lbs.)	57 (125.66) kg (lbs.)	
References					
Steel UL	NSYCUS1K1UL	NSYCUS1K12P4UL	NSYCUS1K5UL	NSYCUS1K52P4UL	
Stainless-steel UL	NSYCUSX1K1UL	NSYCUSX1K12P4UL	NSYCUSX1K5UL	NSYCUSX1K52P4UL	

* Certification UL only 60 Hz.

Technical changes reserved. Information provided without guarantee. Images are for illustrative purposes only.







2000 W (6824 Btu/h)	2000 W (6824 Btu/h)	2500 W (8530 Btu/h)	2500 W (8530 Btu/h)	3200 W (10919 Btu/h)	3200 W (10919 Btu/h)
1550 W (5289 Btu/h)	1550 W (5289 Btu/h)	1850 W (6312 Btu/h)	1850 W (6312 Btu/h)	2500 W (8530 Btu/h)	2500 W (8530 Btu/h)
860 (506.18) m ³ /h (ft ³ /min)	860 (506.18) m ³ /h (ft ³ /min)	1450 (853.44) m ³ /h (ft ³ /min)	1450 (853.44) m ³ /h (ft ³ /min)	1450 (853.44) m ³ /h (ft ³ /min)	1450 (853.44) m ³ /h (ft ³ /min)
1050 (618.01) m ³ /h (ft ³ /min)	1050 (618.01) m ³ /h (ft ³ /min)	1450 (853.44) m ³ /h (ft ³ /min)	1450 (853.44) m ³ /h (ft ³ /min)	1450 (853.44) m ³ /h (ft ³ /min)	1450 (853.44) m ³ /h (ft ³ /min)
Electronic	Electronic	Electronic	Electronic	Electronic	Electronic
+20°C (68°F) ... +46°C (115°F)	+20°C (68°F) ... +46°C (115°F)	+20°C (68°F) ... +46°C (115°F)	+20°C (68°F) ... +46°C (115°F)	+20°C (68°F) ... +46°C (115°F)	+20°C (68°F) ... +46°C (115°F)
+50°C (122°F)	+50°C (122°F)	+50°C (122°F)	+50°C (122°F)	+50°C (122°F)	+50°C (122°F)
+5°C (41°F) ... +50°C (122°F)	+5°C (41°F) ... +50°C (122°F)	+5°C (41°F) ... +50°C (122°F)	+5°C (41°F) ... +50°C (122°F)	+5°C (41°F) ... +50°C (122°F)	+5°C (41°F) ... +50°C (122°F)
R134a	R134a	R134a	R134a	R134a	R134a
0.51 (1.12) kg (lbs.)	0.59 (1.30) kg (lbs.)	1.2 (2.65) kg (lbs.)	1.2 (2.65) kg (lbs.)	0.85 (1.87) kg (lbs.)	1.25 (2.76) kg (lbs.)
28 bar	28 bar	28 bar	28 bar	28 bar	28 bar
Optional, see page 485	Optional, see page 485	Optional, see page 485	Optional, see page 485	Optional, see page 485	Optional, see page 485
1 x 230 V / 60 Hz	3 x 400 V / 50-60 Hz (3 x 460 V / 60 Hz)*	1 x 230 V / 60 Hz	3 x 400 V / 50-60 Hz (3 x 460 V / 60 Hz)*	1 x 230 V / 60 Hz	3 x 400 V / 50-60 Hz (3 x 460 V / 60 Hz)*
24 A / 6.5 A	10 A / 2.1 A	35 A / 10.5 A	14 A / 2.9 A	37 A / 10.5 A	18 A / 3.1 A
1020 W	1060 W	1340 W	1270 W	1720 W	1650 W
1160 W	1270 W	1580 W	1510 W	2000 W	1980 W
2.0	1.9	1.9	2.0	1.9	1.9
T10 A	T6 A	T16 A	T6 A	T16 A	T6 A
1696 (66.77) x 495 (19.49) x 195 (7.68) mm (in.)	1696 (66.77) x 495 (19.49) x 195 (7.68) mm (in.)	1696 (66.77) x 495 (19.49) x 235 (9.25) mm (in.)	1696 (66.77) x 495 (19.49) x 235 (9.25) mm (in.)	1696 (66.77) x 495 (19.49) x 235 (9.25) mm (in.)	1696 (66.77) x 495 (19.49) x 235 (9.25) mm (in.)
IP55 / IP34	IP55 / IP34	IP55 / IP34	IP55 / IP34	IP55 / IP34	IP55 / IP34
67 dB	67 dB	69 dB	69 dB	69 dB	69 dB
63 (138.89) kg (lbs.)	65 (143.30) kg (lbs.)	80 (176.37) kg (lbs.)	82 (180.78) kg (lbs.)	81 (178.57) kg (lbs.)	83 (182.98) kg (lbs.)
NSYCUS2KUL	NSYCUS2K3P4UL	NSYCUS2K5UL	NSYCUS2K53P4UL	NSYCUS3K2UL	NSYCUS3K23P4UL

12
CU

Technical changes reserved. Information provided without guarantee. Images are for illustrative purposes only.

Accessories

Characteristics	Cooling units IEC			Cooling units UL	
	Steel	Stainless-steel	Outdoor	Steel	Stainless-steel
Material					
Color					
Installation					
Supply					
References					
Cooling units					
Side-mounted models	NSYCU300H	-	-	-	-
	NSYCU400	NSYCUX400	NSYCUHD400	NSYCU400UL	-
	NSYCU600	NSYCUX600	NSYCUHD600	NSYCU600UL	NSYCUX600UL
	NSYCU800	NSYCUX800	NSYCUHD800	NSYCU800UL	NSYCUX800UL
	NSYCU1K	NSYCUX1K	NSYCUHD1K	NSYCU1KUL	NSYCUX1KUL
	NSYCU1K2P4	NSYCUX1K2P4	NSYCUHD1K2P4	NSYCU1K2P4UL	NSYCUX1K2P4UL
	NSYCU1K2	NSYCUX1K2	-	NSYCU1K2UL	NSYCUX1K2UL
	NSYCU1K22P4	NSYCUX1K22P4	-	-	-
	NSYCU1K6	NSYCUX1K6	NSYCUHD1K6	NSYCU1K6UL	NSYCUX1K6UL
	NSYCU1K62P4	NSYCUX1K62P4	NSYCUHD1K62P4	NSYCU1K62P4UL	NSYCUX1K62P4UL
	NSYCU2K	NSYCUX2K	-	NSYCU2KUL	NSYCUX2KUL
	NSYCU2K3P4	NSYCUX2K3P4	NSYCUHD2K3P4	NSYCU2K3P4UL	NSYCUX2K3P4UL
	NSYCU3K3P4	NSYCUX3K3P4	NSYCUHD3K3P4	NSYCU3K3P4UL	NSYCUX3K3P4UL
	NSYCU4K3P4	NSYCUX4K3P4	NSYCUHD4K3P4	NSYCU4K3P4UL	NSYCUX4K3P4UL
Floor-standing models	NSYCU6K3P4	-	-	-	-
	-	-	-	-	-
Roof-mounting model	NSYCU400R	NSYCUX400R	-	NSYCU400RUL	-
	NSYCU800R	NSYCUX800R	-	NSYCU800RUL	-
	NSYCU1K2R	NSYCUX1K2R	-	NSYCU1K2RUL	-
	NSYCU1K5R	NSYCUX1K5R	-	NSYCU1K5RUL	-
	NSYCU2K3P4R	NSYCUX2K3P4R	-	NSYCU2K3P4RUL	-
	NSYCU2KR	NSYCUX2KR	-	-	-
	NSYCU3K3P4R	NSYCUX3K3P4R	-	NSYCU3K3P4RUL	-
	NSYCU4K3P4R	NSYCUX4K3P4R	-	NSYCU4K3P4RUL	-
Slim model	-	-	-	NSYCUS1K1UL	NSYCUSX1K1UL
	-	-	-	NSYCUS1K12P4UL	NSYCUSX1K12P4UL
	-	-	-	NSYCUS1K5UL	NSYCUSX1K5UL
	-	-	-	NSYCUS1K52P4UL	NSYCUSX1K52P4UL
	-	-	-	NSYCUS2KUL	NSYCUSX2KUL
	-	-	-	NSYCUS2K3P4UL	NSYCUSX2K3P4UL
	-	-	-	NSYCUS2K5UL	NSYCUSX2K5UL
	-	-	-	NSYCUS2K53P4UL	NSYCUSX2K53P4UL
	-	-	-	NSYCUS3K2UL	NSYCUSX3K2UL
	-	-	-	NSYCUS3K23P4UL	NSYCUSX3K23P4UL

							
Filters				Internal deflector		Retrofit panel	
Plastic filter not recommended for outdoor models.		Metallic filter recommended for outdoor models.		Deflects the air inside the enclosure.		Panel that enable to mount a new ClimaSys CU units by replacement of old Schneider Electric cooling systems.	
Polyurethane		Micro-stretched aluminum		Zinc-coated		Metal painted	
Black		-		RAL 7035 grey		RAL 7035 grey	
Indoor		Indoor or outdoor		Indoor or outdoor		Indoor	
5 units		1 unit		1 unit with fixing elements		1 unit	
						Old Schneider Electric cooling system	
-	-	-	-	-	-	-	-
NSYCUF400	NSYCUFX400	NSYCUDA400	NSYCU240W230VL	NSYCU370W230VL			
NSYCUF600	NSYCUFX600	NSYCUDA600	-				
NSYCUF800T1K	NSYCUFX800T1K	NSYCUDA800T1K	NSYCU760W230VL				
NSYCUF800T1K	NSYCUFX800T1K	NSYCUDA800T1K	NSYCUE1100W230L				
NSYCUF800T1K	NSYCUFX800T1K	NSYCUDA1K2T2K	NSYCU1K				
NSYCUF1K2T2K	NSYCUFX1K2T2K	NSYCUDA1K2T2K	-				
NSYCUF1K2T2K	NSYCUFX1K2T2K	NSYCUDA1K2T2K	-				
NSYCUF1K2T2K	NSYCUFX1K2T2K	NSYCUDA1K2T2K	NSYCUE1400W230L				
NSYCUF1K2T2K	NSYCUFX1K2T2K	NSYCUDA1K2T2K	NSYCUE1650W230VL				
NSYCUF1K2T2K	NSYCUFX1K2T2K	NSYCUDA1K2T2K	NSYCU1400W400L				
NSYCUF1K2T2K	NSYCUFX1K2T2K	NSYCUDA1K2T2K	-				
NSYCUF1K2T2K	NSYCUFX1K2T2K	NSYCUDA1K2T2K	NSYCU1800W400VL				
NSYCUF3KT4K	NSYCUFX3KT4K	NSYCUDA3KT4K	NSYCUE1800W400L				
NSYCUF3KT4K	NSYCUFX3KT4K	NSYCUDA3KT4K	NSYCU2500W400VL				
NSYCUF6K	NSYCUFX6K	-	NSYCU4000W400VL				
NSYCUF6K	NSYCUFX6K	-	-				
NSYCUF400R	NSYCUFX400R	-	-				
NSYCUF800R	NSYCUFX800R	-	NSYCU760W230VR				
NSYCUF1K2T2KR	NSYCUFX1K2T2KR	-	NSYCU1050W230VR				
NSYCUF1K2T2KR	NSYCUFX1K2T2KR	-	NSYCUE1400W230R				
NSYCUF1K2T2KR	NSYCUFX1K2T2KR	-	NSYCU1460W230VR				
NSYCUF1K2T2KR	NSYCUFX1K2T2KR	-	NSYCU1650W230VR				
NSYCUF1K2T2KR	NSYCUFX1K2T2KR	-	NSYCUE1800W400R				
NSYCUF1K2T2KR	NSYCUFX1K2T2KR	-	NSYCU2000W400VR				
NSYCUF3KT4KR	NSYCUFX3KT4KR	-	NSYCU2450W400VR				
NSYCUF3KT4KR	NSYCUFX3KT4KR	-	NSYCU3100W400VR				
NSYCUF3KT4KR	NSYCUFX3KT4KR	-	-				
NSYCUF1K1T2KS	NSYCUFX1K1T2KS	NSYCUDA1K1T1K5	NSYCUB1100W230S				
NSYCUF1K1T2KS	NSYCUFX1K1T2KS	NSYCUDA1K1T1K5	NSYCUB1100W400S				
NSYCUF1K1T2KS	NSYCUFX1K1T2KS	NSYCUDA1K1T1K5	NSYCUB1500W230S				
NSYCUF1K1T2KS	NSYCUFX1K1T2KS	NSYCUDA1K1T1K5	NSYCUB1500W400S				
NSYCUF1K1T2KS	NSYCUFX1K1T2KS	NSYCUDA1K1T1K5	NSYCUB2200W230S				
NSYCUF1K1T2KS	NSYCUFX1K1T2KS	NSYCUDA1K1T1K5	NSYCUB2200W400S				
NSYCUF1K1T2KS	NSYCUFX1K1T2KS	NSYCUDA1K1T1K5	NSYCUB2700W230S				
NSYCUF1K1T2KS	NSYCUFX1K1T2KS	NSYCUDA1K1T1K5	NSYCUB2700W400S				
NSYCUF1K1T2KS	NSYCUFX1K1T2KS	NSYCUDA1K1T1K5	NSYCUB2700W230S				
NSYCUF1K1T2KS	NSYCUFX1K1T2KS	NSYCUDA1K1T1K5	NSYCUB2700W400S				

Side-mounted models: Dimensions and cut-outs

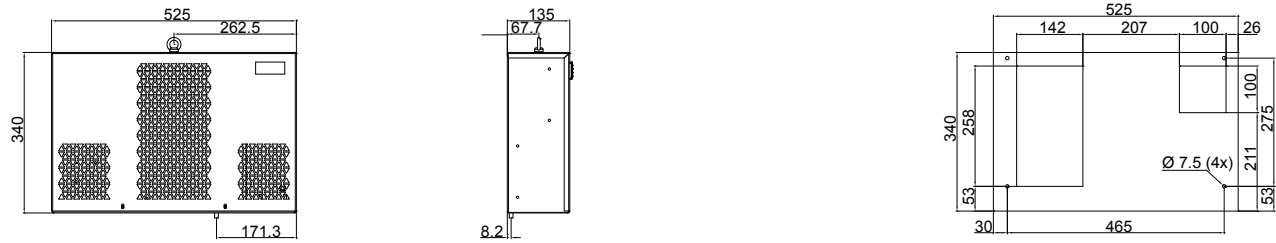

NSYCU300H

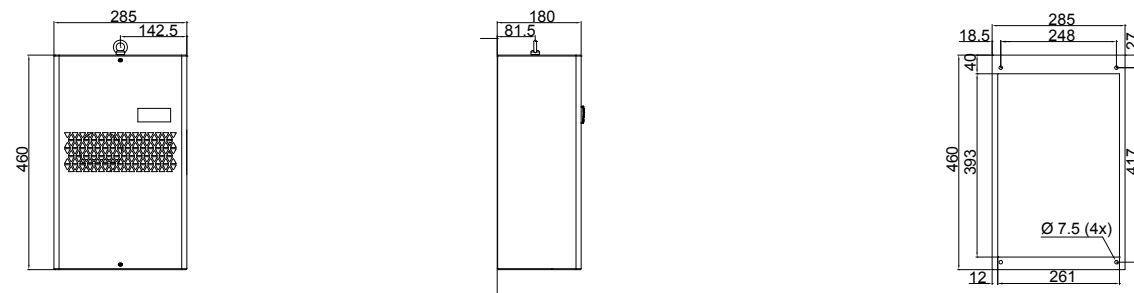

NSYCU●●400●●

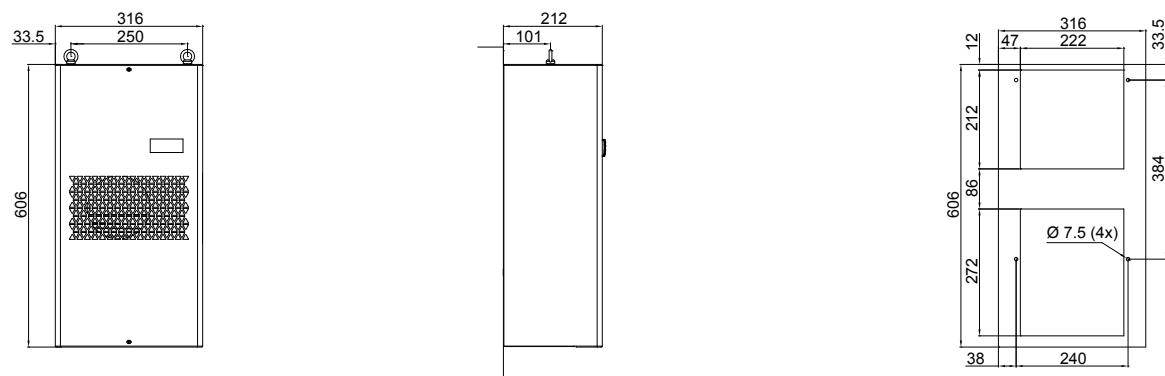

NSYCU●●600●●

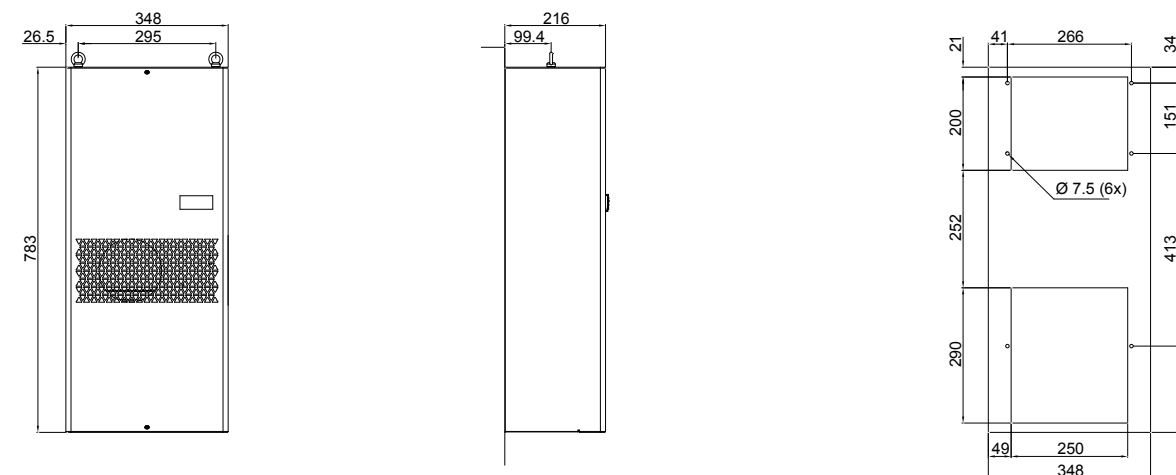

NSYCU●●800●● - NSYCU●●1K●●

Units of measurement are mm

Technical changes reserved. Information provided without guarantee. Images are for illustrative purposes only.

Side-mounted models: Dimensions and cut-outs

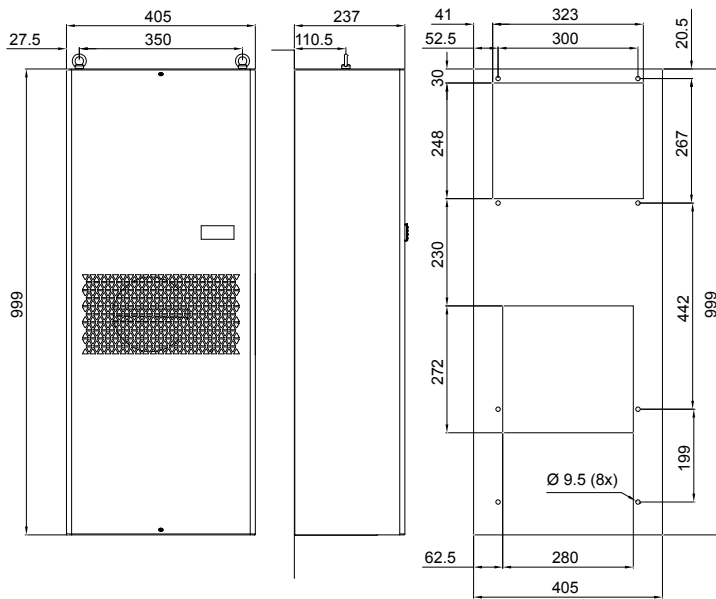

NSYCU●●1K2●● - NSYCU●●1K6●● - NSYCU●●2K●●

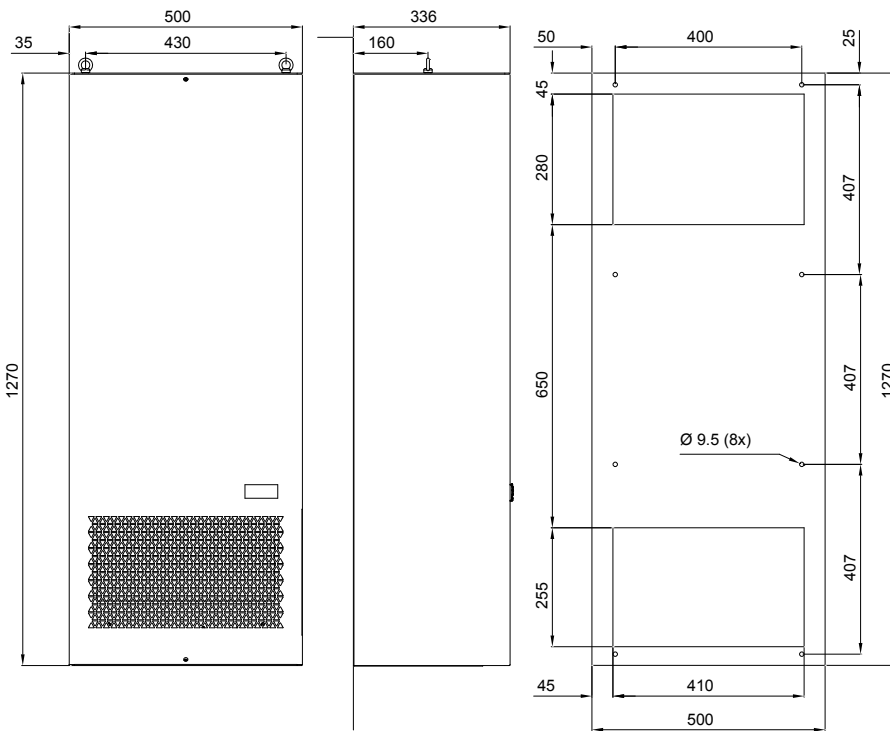

NSYCU●●3K3P4●● - NSYCU●●4K3P4●●

Units of measurement are mm

Top-mounted models: Dimensions and cut-outs

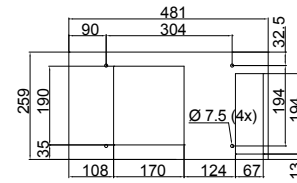
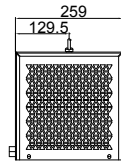
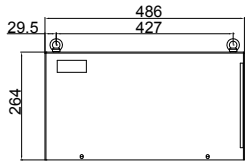

NSYCU400R

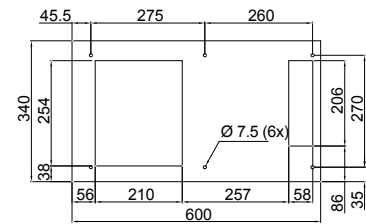
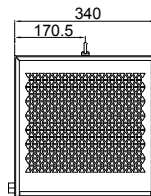
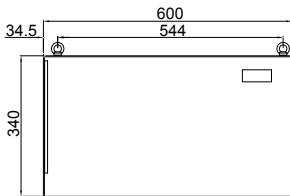

NSYCU800R

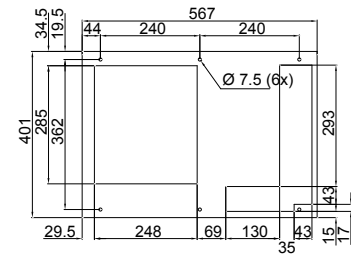
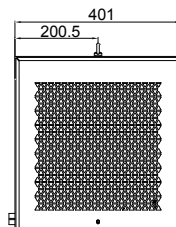
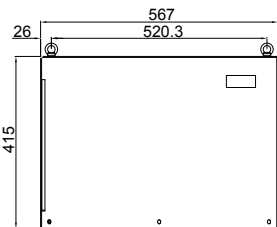

NSYCU1K2R - NSYCU1K5R - NSYCU2K

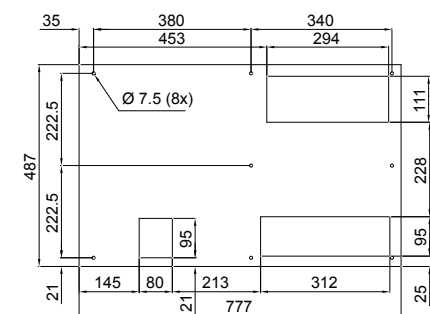
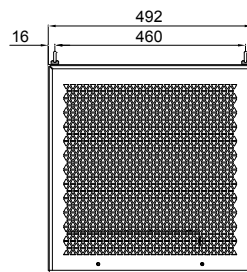
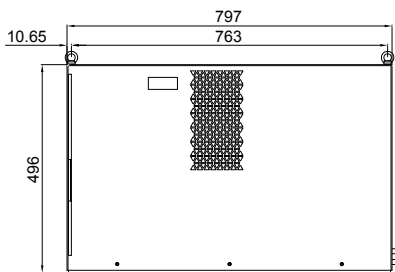

NSYCU3K3P4R - NSYCU4K3P4R

Units of measurement are mm

Top-mounted models: Dimensions and cut-outs

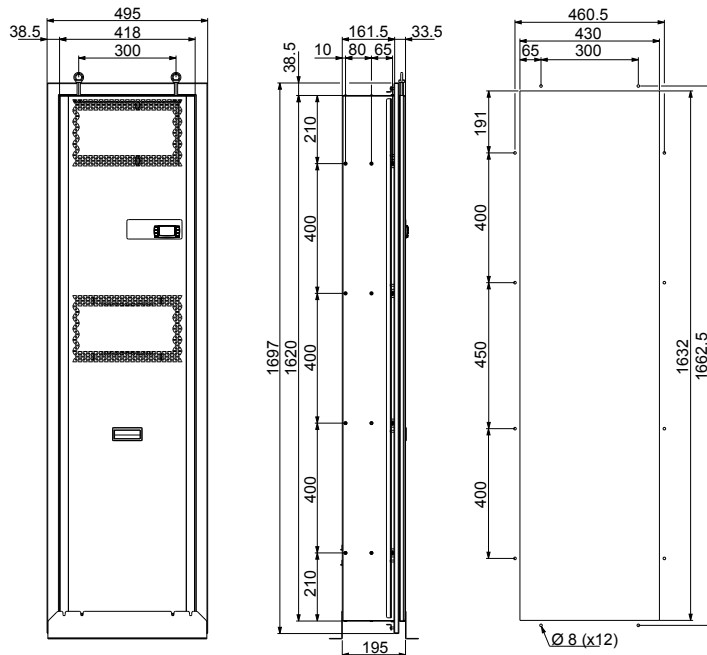

NSYCUS●1K1● - NSYCUS●1K5● - NSYCUS●2K●

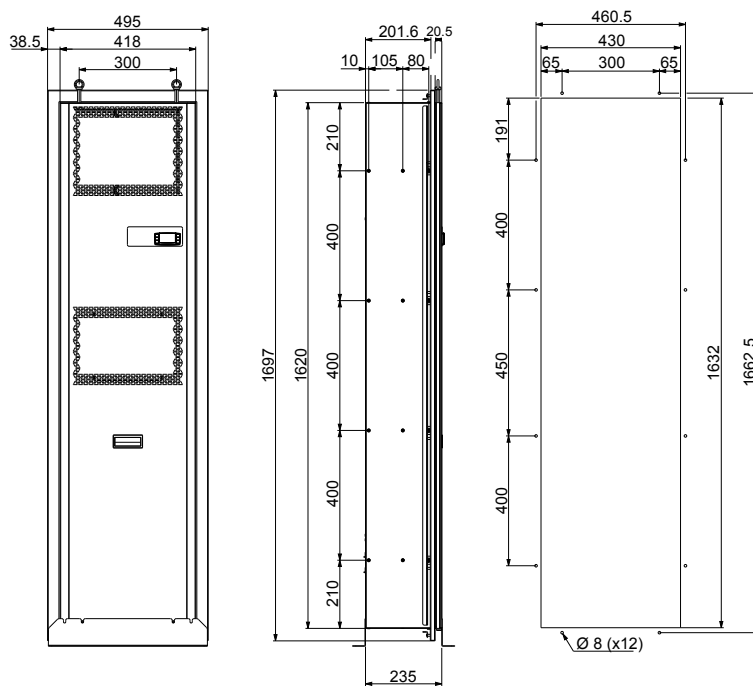

NSYCUS2K5UL

Units of measurement are mm

Ultra-thin resistance heaters have been designed to resolve condensation problems in the most complex installations.

Is your enclosure short of space?

Does your mounting plate make it impossible to install a conventional heater?

Do you not want to take out the equipment?

Discover the benefits of this new offer and its numerous mounting solutions.

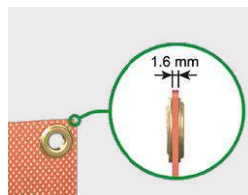
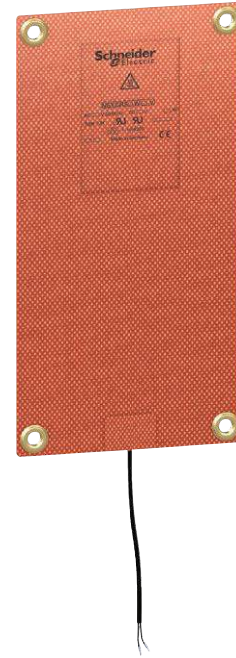

Small size (thickness = 1.6 (0.06) mm (in.))

- The space saving available for the equipment compared with a conventional resistor can be up to 30%.



Numerous positions for installation

- These heaters are so slim and flexible they can be installed in a variety of positions:
- Vertically on side panels
- On the mounting plate.



Heat and safety

- The heat is distributed over the whole surface and does not exceed 70°C (158°F). This temperature allows devices next to the heater to be handled safely.



Energy efficiency

- Ultra-thin resistance heaters have a low starting current.



Multiple options for fixing

- Innovative quick-fixing system using Velcro pads (no need for a tool!) or with basic fixing accessories (screw + spacer). These systems make it easy to move the heater if necessary.



No electromagnetic emissions

- These resistors can be installed near electronic equipment to ensure an optimal temperature.

Other characteristics - Electrical circuit diagram



5 mounting solutions:	On a Telequick mounting plate	On plain or micro-perforated mounting plate with fixing hardware	On DIN rail	On plain mounting plate with self-adhesive Velcro pads	On wall with self-adhesive Velcro pads
	<p>A Telequick mounting plate, ref. NSYMR●●●● B Telequick nuts, ref. AF1EA●, supplied with the mounting kit</p>	<p>A Mounting plate, ref. NSYMM●●●● B Fixing hardware included in the mounting kit</p>	<p>A Mounting plate, ref. NSYMM●●●● B Symmetrical DIN rail, ref. NSYSDR●●●● C Clip-on nuts, ref. AF1CG●, supplied with the mounting kit</p>	<p>A Mounting plate, ref. NSYMM●●●● B Self-adhesive Velcro pad and plastic fixings supplied with the mounting kit</p>	<p>A Self-adhesive Velcro pads and plastic fixings supplied in the mounting kit</p>
Characteristics	PB502046	PB502047	PB502048	PB502049	PB502522
Material	Flexible, ultra-thin resistance heaters to be installed inside the enclosure				
Color	Silicon reinforced with fiberglass				
Certifications	Red (heaters), black (cables)				
Supply	VDE, LR				
	<ul style="list-style-type: none"> • 6 self-adhesive Velcro pads • 6 plastic fixings • 4 Telequick nuts • 4 clip-on nuts • Fixing hardware 				

Ultra-thin resistance heaters

Flexible, ultra-thin resistance heaters to be installed inside the enclosure

- Material: Silicon reinforced with fiberglass
- Color: Red (heaters), black (cables)
- Certifications: VDE, LR

Comment:

Ultra-thin resistance heaters can be manufactured with other dimensions and power ratings than those indicated above. Please contact us.

Characteristics	Power (W)	Voltage (V)	Inrush current (A)	Height mm (in.)	Width mm (in.)	Depth mm (in.)	References
Ultra-thin resistance heaters	10	240	0.04	110 (4.33)	140 (5.51)	1.6 (0.06)	NSYCRS10W240V
Ultra-thin resistance heaters	25	240	0.10	110 (4.33)	230 (9.06)	1.6 (0.06)	NSYCRS25W240V
Ultra-thin resistance heaters	50	240	0.21	200 (7.87)	320 (12.60)	1.6 (0.06)	NSYCRS50W240V
Ultra-thin resistance heaters	100	240	0.42	260 (10.24)	440 (17.32)	1.6 (0.06)	NSYCRS100W240V
Ultra-thin resistance heaters	200	240	0.83	380 (14.96)	650 (25.59)	1.6 (0.06)	NSYCRS200W240V

Resistance heaters prevent the formation of condensation and help guarantee the correct temperature for the correct operation of the electronic components in the enclosure.

Insulated PTC heaters

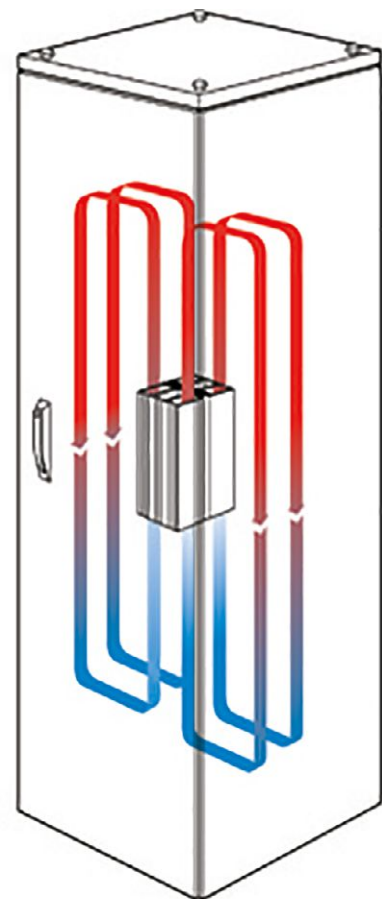

Large range of power levels

- 2 versions: By natural convection or by fan.
- AC or DC power supply.
- 7 power levels from 10 W to 550 W.



Easy installation and connection

- Reduced dimensions.
- Quick electric connection by terminal board.
- No maintenance required.
- Direct clipping onto a 35 (1.38) mm (in.) DIN rail.



Innovating design



Safety

- The protection prevents direct contact with the aluminum radiator.
- Electric protection device with terminal block cover.
- Equipped with a PTC-type heater.
- Surface temperature lower than 70°C (158°F)



Models with fan

- The heaters equipped with a fan helps to ensure circulation of the air and a uniform temperature inside the enclosure.
- High-flow, silent fan.

High thermal efficiency

- The configuration of the aluminum profile produces a "chimney" effect: high natural convection.
- Low power consumption thanks to self-control of the PTC-type heater.



Certifications

- CE marking.
- Range compliant with UL and VDE.

Aluminum PTC heaters

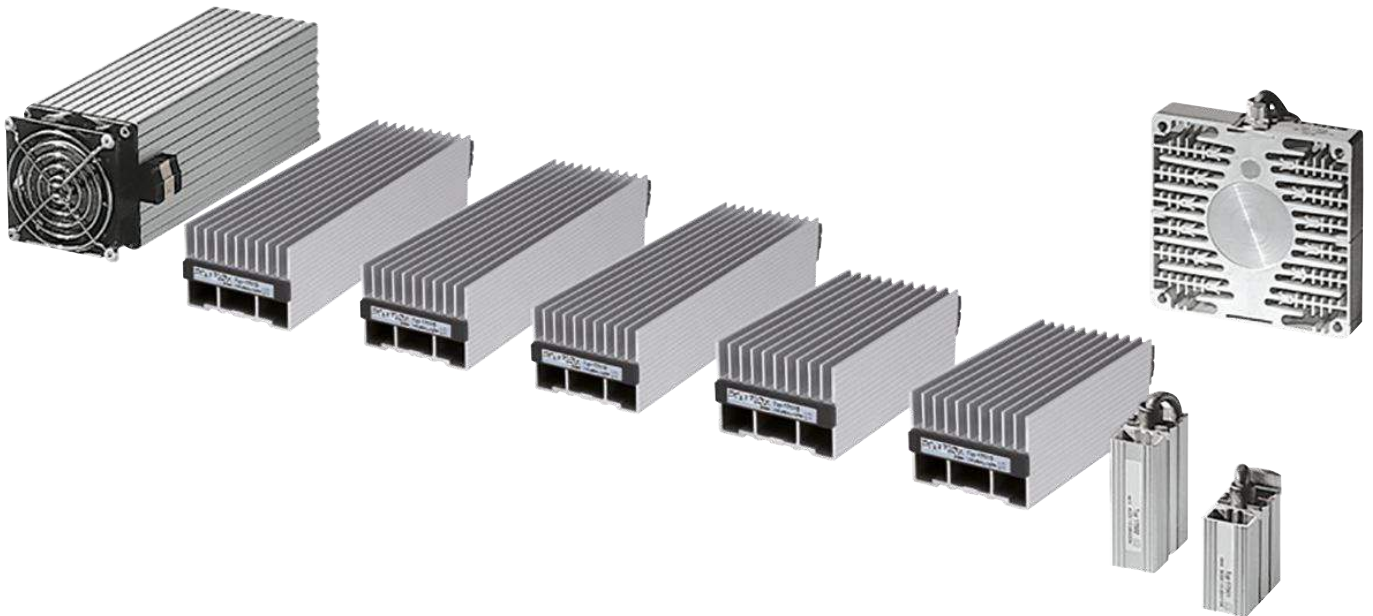

Models with fan

- Models of 250 to 400 W with fan.



Connection cables

- The 10 and 20-W heaters are equipped with a 2 (0.08) x 0.75 (0.03) x 300 (11.81) mm (in.) power cord.



Quick-fixing

- The resistance heaters are fixed by means of fixing clips to a 35 (1.38) mm (in.) DIN rail.



Connection terminal boards

- Heaters with a power of more than 20 W are equipped with a connection terminal board.



Resistance heaters equipped with a PTC-type sensor

The resistance heaters for electrical and electronic enclosures are equipped with PTC-type heating devices (Positive Temperature Coefficient). Thanks to these heaters:

- The surface temperature stabilises at 75°C (167°F) when the ambient temperature is -5°C (23°F)
- Power consumption is reduced.

Improved convection

- The design of the profile of the resistance heaters produces a "chimney" effect, leading to increased natural convection and maintaining an even temperature inside the enclosure.

Large range of power levels

- 8 power levels from 10 W to 400 W.

Technical changes reserved. Information provided without guarantee. Images are for illustrative purposes only.

Insulated PTC resistance heaters

- Compact resistance heater preventing the formation of condensation or frost.
- Designed to ensure natural convection and high thermal efficiency.
- Material: Extruded aluminum body
- Conditions of use: The heaters must be installed with a thermal controller (see selection table on [page 496](#) and [497](#)) to control the temperature or the humidity inside the enclosure
- The enclosure must be sealed to prevent the entry of air from the outside
- An electrical protection device must be installed on the supply side of the unit
- Operating position: Vertical
- Operating temperature: -40°C (-40°F) ...+ 70°C (158°F); -10°C (14°F) ...+ 158°C (316°F)
- Surface temperature: < 70°C (158°F) except for the top protection grille
- Ingress protection rating: IP20
- Certifications: VDE and UL, Cover: UL 94 V-0 plastic, Class II (double insulated)
- Mounting: By clip on a 35 (1.38) mm (in.) DIN rail



NSYCR10WU2C



NSYCR50WU2C

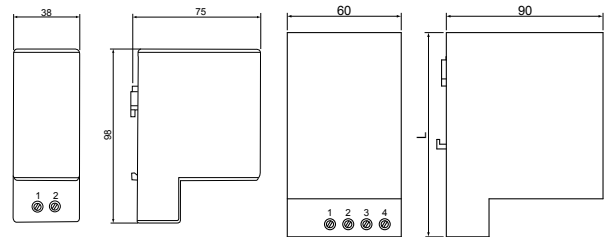

Characteristics	Heating power at 0°C (32°F) (W)	Voltage (V)	Electric connection	References
Insulated PTC resistance heater	10	12-24V	2 poles, 2.5 mm ²	NSYCR10WU1C
Insulated PTC resistance heater	10	110-250V	2 poles, 2.5 mm ²	NSYCR10WU2C
Insulated PTC resistance heater	20	12-24V	2 poles, 2.5 mm ²	NSYCR20WU1C
Insulated PTC resistance heater	20	110-250V	2 poles, 2.5 mm ²	NSYCR20WU2C
Insulated PTC resistance heater	50	12-24V	4 poles, 2.5 mm ²	NSYCR50WU1C
Insulated PTC resistance heater	50	110-250V	4 poles, 2.5 mm ²	NSYCR50WU2C
Insulated PTC resistance heater	50	270-420V	4 poles, 2.5 mm ²	NSYCR50WU3C
Insulated PTC resistance heater	100	12-24V	4 poles, 2.5 mm ²	NSYCR100WU1C
Insulated PTC resistance heater	100	110-250V	4 poles, 2.5 mm ²	NSYCR100WU2C
Insulated PTC resistance heater	100	270-420V	4 poles, 2.5 mm ²	NSYCR100WU3C
Insulated PTC resistance heater	150	110-250V	4 poles, 2.5 mm ²	NSYCR150WU2C

Insulated ventilated PTC heaters

- Compact resistance heater preventing the formation of condensation or frost.
- Designed to ensure natural convection and high thermal efficiency.
- Material: Extruded aluminum body
- Conditions of use: The heaters must be installed with a thermal controller (see selection table on [page 496](#) and [497](#)) to control the temperature or the humidity inside the enclosure
- The enclosure must be sealed to prevent the entry of air from the outside
- An electrical protection device must be installed on the supply side of the unit
- Operating position: Vertical
- Operating temperature: -40°C (-40°F) ...+ 70°C (158°F) ; -10°C (14°F) ...+ 158°C (316°F)
- Surface temperature: Max. 50°C (122°F) in the enclosure, 100°C (212°F) on the top protection grille, (for an ambient temperature of 20°C (68°F) / 68°C (154°F))
- Ingress protection rating: IP20
- Certifications: VDE and UL, Cover: UL 94 V-0 plastic, Class II (double insulated)
- Mounting: By clip on a 35 (1.38) mm (in.) DIN rail

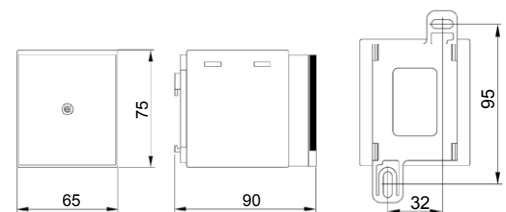

Characteristics	Heating power at 0°C (32°F) (W)	Voltage (V)	Electric connection	References
Insulated ventilated PTC heater	177	230 AC / 50-60 HZ	2 poles, 2.5 mm ²	NSYCR170W230VC



NSYCR170W230VC

Aluminum PTC heaters

- Extruded aluminum body.
- Surface temperature limited to 75°C (167°F) when the ambient temperature is -5°C (23°F)
- Heaters equipped with a power cable with a length of 500 (19.68) mm (in.) with silicon insulation, or with a connection terminal block.

Conditions of use:

- The heaters must be installed with a thermal controller to control the temperature or the humidity inside the enclosure
- The enclosure must be sealed to help prevent the entry of air from the outside
- An electrical protection device must be installed on the supply side of the unit



NSYCR10WU1



NSYCR250W115VV

Characteristics	Power (W)	Voltage (V)	References
Aluminum PTC heater	10	12-24 DC	NSYCR10WU1
Aluminum PTC heater	10	110-250 AC	NSYCR10WU2
Aluminum PTC heater	20	12-24 DC	NSYCR20WU1
Aluminum PTC heater	20	110-250 AC	NSYCR20WU2
Aluminum PTC heater	20	270-420 AC	NSYCR20WU3
Aluminum PTC heater	55	12-24 DC	NSYCR55WU1
Aluminum PTC heater	55	110-250 AC	NSYCR55WU2
Aluminum PTC heater	55	270-420 AC	NSYCR55WU3
Aluminum PTC heater	90	12-24 DC	NSYCR100WU1
Aluminum PTC heater	90	110-250 AC	NSYCR100WU2
Aluminum PTC heater	90	270-420 AC	NSYCR100WU3
Aluminum PTC heater	150	12-24 DC	NSYCR150WU1
Aluminum PTC heater	150	110-250 AC	NSYCR150WU2
Aluminum PTC heater	150	270-420 AC	NSYCR150WU3
Aluminum PTC heater with fan	250	115 AC	NSYCR250W115VV
Aluminum PTC heater with fan	250	230 AC	NSYCR250W230VV
Aluminum PTC heater with fan	400	115 AC	NSYCR400W115VV
Aluminum PTC heater with fan	400	230 AC	NSYCR400W230VV
Resistive heater	200	230 AC	NSYCRS200W230V

Thermofan



NSYCRP1W120VTVC

Combination of a resistance heater and an axial fan to ensure uniform heating of the enclosure.

- Fixing by clip on a DIN rail.
- Thermostat adjustable from 0°C (32°F) ...+ 60°C (140°F)
- Visual operation indicator.

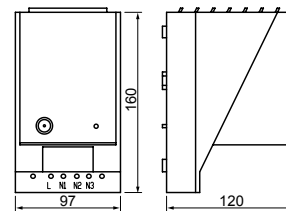

Characteristics	Power (W)	Voltage (V)	References
Thermofan	350/550	120 AC	NSYCRP1W120VTVC
Thermofan	350/550	230 AC	NSYCRP1W230VTVC

Mechanical thermostats

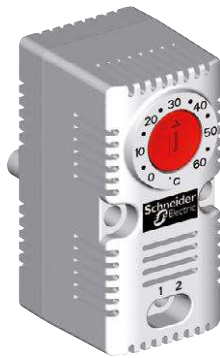

Thermostat with NC contact



Thermostat with NO contact



Thermostat with NO/NC contact



Double Thermostat

Characteristics	NSYCCOTHC (NSYCCOTHCF)	NSYCCOTH0 (NSYCCOTH0F)	NSYCCOTH1	NSYCCOTH D (NSYCCOTHDF)
	Thermostat with NC Contact: <ul style="list-style-type: none"> To control the stopping of a resistance heater when the temperature exceeds the displayed value. Thermostat with NO Contact: <ul style="list-style-type: none"> To control the starting of a fan when the temperature exceeds the displayed maximum value, To control the temperature inside the enclosure by only starting the fan when necessary, thus increasing the service life of the fan and reducing the clogging of the filter. 			
Button color	Red	Blue	Black	Red and blue
Ingress protection rating	IP20	IP20	IP20	IP20
Sensor element	Bimetal	Bimetal	Bimetal	Bimetal
Contact	NC, forced rupture	NC, forced rupture	Inverse, forced rupture	NO/NC, forced rupture
Contact resistance	< 10 mΩ	< 10 mΩ	< 10 mΩ	< 10 mΩ
Service life	> 100,000 cycles	> 100,000 cycles	> 100,000 cycles	> 100,000 cycles
Switching capacity	<ul style="list-style-type: none"> 250 V AC; 10 A (resistive load) 120 V AC; 15 A (resistive load) 250 V AC/120 V AC 2 A (inductive load cos φ = 0.6) 30 W DC 	<ul style="list-style-type: none"> 250 V AC; 10 A (resistive load) 120 V AC; 15 A (resistive load) 250 V AC/120 V AC 2 A (inductive load cos φ = 0.6) 30 W DC 	<ul style="list-style-type: none"> 250 V AC; 10 A (resistive load) 	<ul style="list-style-type: none"> 250 V AC; 10 A (resistive load) 120 V AC; 15 A (resistive load) 250 V AC/120 V AC 2 A (inductive load cos φ = 0.6) 30 W DC
Max interrupting capacity with direct current	NC	NO	250 V AC 4 A (inductive load cos φ = 0.6) 30 W DC	NA
Connection	Two 2.5 mm ² terminals	Two 2.5 mm ² terminals	Four 2.5 mm ² terminals	Six 2.5 mm ² terminals
Mounting	By clip on 35 (1.38) mm (in.) DIN rail	By clip on 35 (1.38) mm (in.) DIN rail	By clip on 35 (1.38) mm (in.) DIN rail	By clip on 35 (1.38) mm (in.) DIN rail
Enclosure	UL 94 V-0 plastic, light grey	UL 94 V-0 plastic, light grey	UL 94 V-0 plastic, light grey	UL 94 V-0 plastic, light grey
Dimensions	60 (2.36) x 33 (1.30) x 43 (1.69) mm (in.)	60 (2.36) x 33 (1.30) x 43 (1.69) mm (in.)	67 (2.64) x 50 (1.97) x 44 (1.73) mm (in.)	60 (2.36) x 33 (1.30) x 43 (1.69) mm (in.)
Weight	40 (1.41) g (oz.)	40 (1.41) g (oz.)	100 (0.22) g (lbs.)	40 (1.41) g (oz.)
Mounting position	Indifferent	Indifferent	Indifferent	Indifferent
Operating temperature	-20°C (-4°F) ...+ 80°C (176°F) (-4°C (25°F) ...+ 176°C (349°F))	-20°C (-4°F) ...+ 80°C (176°F) (-4°C (25°F) ...+ 176°C (349°F))	-20°C (-4°F) ...+ 80°C (176°F) (-4°C (25°F) ...+ 176°C (349°F))	-20°C (-4°F) ...+ 80°C (176°F) (-4°C (25°F) ...+ 176°C (349°F))
Hysteresis	7 K	7 K	7 K	7 K
Temperature setting range	0°C (32°F) ...+ 60°C (140°F)	0°C (32°F) ...+ 60°C (140°F)	5°C (41°F) ...+ 60°C (140°F)	0°C (32°F) ...+ 60°C (140°F)
Display	°C (°F)	°C (°F)	°C (°F)	°C (°F)
Max. command intensity	10 A 250 V	10 A 250 V	(NO) 5 A (NC) 10 A	(NO) 5 A (NC) 10 A

Thermal control



Mechanical and electronic thermostats

- Large range of temperature control.
- Small dimensions.
- Easily accessible terminals.



Operational temperature range

- For mechanical thermostats: 0°C (32°F) ... +60°C (140°F)
- For electronic thermostats: -40°C (-40°F) ... +80°C (176°F)



LED display

- Display visible even in the dark.

Technical changes reserved. Information provided without guarantee. Images are for illustrative purposes only.

Electronic thermostats with LED display



Electronic thermostat With LED display



Electronic hygrothermostat With LED display



Electronic hygrometer With LED display

Characteristics	NSYCCOTH30VID NSYCCOTH120VID NSYCCOTH230VID	NSYCCOHYT30VID NSYCCOHYT120VID NSYCCOHYT230VID	- - NSYCCOHY230VID
	Electronic temperature controller	Electronic temperature and humidity controller	Electronic humidity controller
Ingress protection rating	IP20	IP20	IP20
Certification	UL / UR	UL / UR	UL / UR
Internal sensor element	Temperature sensor	Temperature sensor and humidity sensor	Humidity sensor
Contact	Free with zero potential	Free with zero potential	Free with zero potential
Connection	2 x 2.5 mm ² (input voltage) + 2 relays (2 x 2.5 mm ² + 2 x 2.5 mm ²)	2 x 2.5 mm ² (input voltage) + 2 relays (2 x 2.5 mm ² + 2 x 2.5 mm ²)	2 x 2.5 mm ² (input voltage) + 1 relay (2 x 2.5 mm ²)
Mounting	4 different methods: By DIN rail, Spacial SF profile, on VDI cross-rail or on mounting plate		
Enclosure	UL 94 V-0 plastic, light grey	UL 94 V-0 plastic, light grey	UL 94 V-0 plastic, light grey
Operating temperature	-40°C (-40°F) ...+ 70°C (158°F)	-40°C (-40°F) ...+ 70°C (158°F)	-40°C (-40°F) ...+ 70°C (158°F)
Hysteresis	Programmed 2 K	Programmed 2 K and 3%	3%
Temperature setting range	-40°C (-40°F) ...+ 80°C (176°F)	-40°C (-40°F) ...+ 80°C (176°F)	-40°C (-40°F) ...+ 80°C (176°F)
Humidity setting range	-	20%...80%	20%...80%
Display	°C or °F	°C or °F or % RH	% RH
Max. command current	8 (5) A 230 V AC / 5 A 30 V DC	8 (5) A 230 V AC / 5 A 30 V DC	8 (5) A 230 V AC / 5 A 30 V DC

The new quick-fixing systems

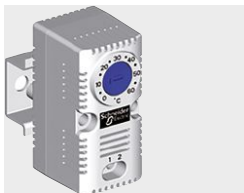

- On 35 (1.38) mm (in.) DIN rail.



Certifications and declarations

- UL
- CE



- On Spacial upright.

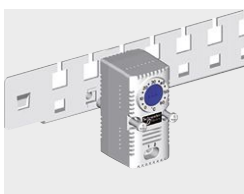

- On cross-rail.

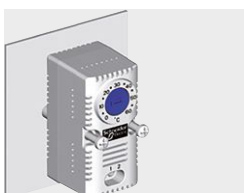

- On mounting plate.

Mechanical thermostats

- Ingress protection rating according to IEC 60529: IP20
- Sensor element: Bimetal
- Contact resistance: < 10 mΩ
- Service life: > 100,000 cycles
- Mounting: By clip on 35 (1.38) mm (in.) DIN rail
- Enclosure: UL 94 V-0 plastic, light grey
- Mounting position: Indifferent
- Operating temperature: -20°C (-4°F) ...+ 80°C (176°F) (-4°C (25°F) ...+ 176°C (349°F))
- Hysteresis: 7 K

Thermostat with NC contact



NSYCCOTHC

- Button color: Red
- Contact: NC, forced rupture
- Switching capacity: 250 V AC; 10 A (resistive load)
120 V AC; 15 A (resistive load)
250 V AC/120 V AC 2 A (inductive load cos = 0.6)
30 W DC
- Max interrupting capacity with direct current: NC
- Connection: Two 2.5 mm² terminals
- Weight: 40 (1.41) g (oz.)
- Temperature setting range: 0°C (32°F) ...+ 60°C (140°F)

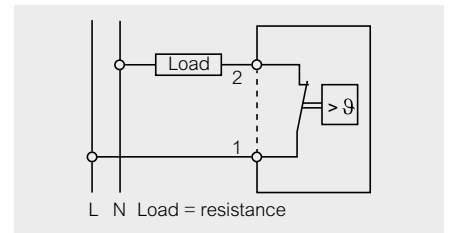

Characteristics	Display	Max. command intensity	Dimensions (H x W x D)	References
Thermostat with NC contact	°C	10 A 250 V	60 (2.36) x 33 (1.30) x 43 (1.69) mm (in.)	NSYCCOTHC
Thermostat with NC contact	°F	10 A 250 V	60 (2.36) x 33 (1.30) x 43 (1.69) mm (in.)	NSYCCOTHCF

Thermostat with NO contact



NSYCCOTHO

- Button color: Blue
- Contact: NO, forced rupture
- Switching capacity: 250 V AC; 10 A (resistive load)
120 V AC; 15 A (resistive load)
250 V AC/120 V AC 2 A (inductive load cos = 0.6)
30 W DC
- Max interrupting capacity with direct current: NO
- Connection: Two 2.5 mm² terminals
- Weight: 40 (1.41) g (oz.)
- Temperature setting range: 0°C (32°F) ...+ 60°C (140°F)

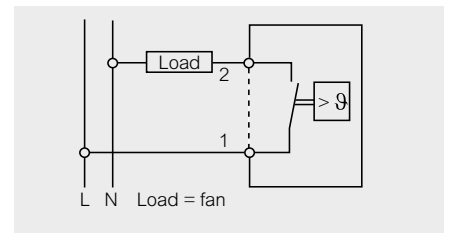

Characteristics	Display	Max. command intensity	Dimensions (H x W x D)	References
Thermostat with NO contact	°C	10 A 250 V	60 (2.36) x 33 (1.30) x 43 (1.69) mm (in.)	NSYCCOTHO
Thermostat with NO contact	°F	10 A 250 V	60 (2.36) x 33 (1.30) x 43 (1.69) mm (in.)	NSYCCOTHOF

Thermostat with NO/NC contact



NSYCCOTHI

- Button color: Black
- Contact: Inverse, forced rupture
- Switching capacity: 250 V AC; 10 A (resistive load)
- Max interrupting capacity with direct current: 250 V AC 4 A (inductive load cos = 0.6) 30 W DC
- Connection: Four 2.5 mm² terminals
- Weight: 100 (0.22) g (lbs.)
- Temperature setting range: +5°C (41°F) ...+ 60°C (140°F)

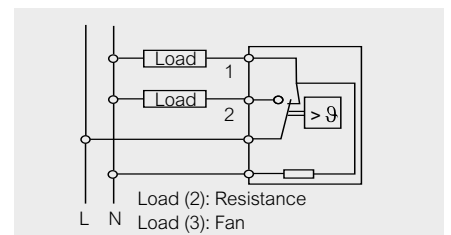

Characteristics	Display	Max. command intensity	Dimensions (H x W x D)	References
Thermostat with NO/NC contact	°C	(NO) 5 A (NC) 10 A	67 (2.64) x 50 (1.97) x 44 (1.73) mm (in.)	NSYCCOTHI

Double Thermostat



NSYCCOTHD

- Button color: Red and blue
- Contact: NO/NC, forced rupture
- Switching capacity: 250 V AC; 10 A (resistive load)
120 V AC; 15 A (resistive load)
250 V AC/120 V AC 2 A (inductive load cos = 0.6)
30 W DC
- Max interrupting capacity with direct current: NA
- Connection: Six 2.5 mm² terminals
- Weight: 40 (1.41) g (oz.)
- Temperature setting range: 0°C (32°F) ...+ 60°C (140°F)

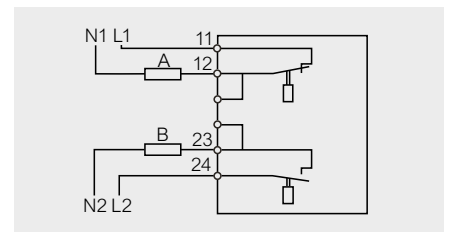

Characteristics	Display	Max. command intensity	Dimensions (H x W x D)	References
Double Thermostat	°C	(NO) 5 A (NC) 10 A	60 (2.36) x 33 (1.30) x 43 (1.69) mm (in.)	NSYCCOTHD
Double Thermostat	°F	(NO) 5 A (NC) 10 A	60 (2.36) x 33 (1.30) x 43 (1.69) mm (in.)	NSYCCOTHDF

Electronic thermostats

- Ingress protection rating according to IEC 60529: IP20
- Certification: UL / UR
- Contact resistance: Free with zero potential
- Mounting: 4 methods: By DIN rail, Spacial SF profile, on VDI cross-rail or on mounting plate
- Enclosure: UL 94 V-0 plastic, light grey
- Operating temperature: -40°C (-40°F) ...+ 70°C (158°F)
- Hysteresis: 7 K
- Max. command intensity: Motor: 4 / 13.1 A, FLA / LRA, 250 Vac
Resistive load: 4 A, 250 Vdc

Electronic thermostats with LED display



NSYCCOTH30VID

- Internal sensor element: Temperature sensor
- Connection: 2 x 2.5 mm² (input voltage) + 2 relays (2 x 2.5 mm² + 2 x 2.5 mm²)
- Hysteresis: Programmed 2 K
- Temperature setting range: -40°C (-40°F) ...+ 80°C (176°F)

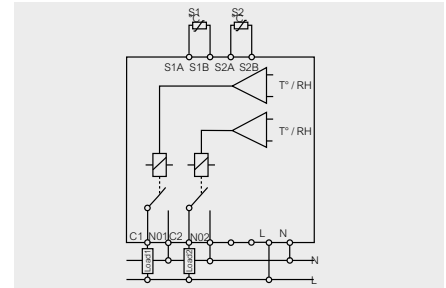

Characteristics	Display	Voltage (type of current)	References
Electronic thermostats, with LED display	°C or °F	9-30 V (AC/DC)	NSYCCOTH30VID
Electronic thermostats, with LED display	°C or °F	90-140 V (AC)	NSYCCOTH120VID
Electronic thermostats, with LED display	°C or °F	200-240 V (AC)	NSYCCOTH230VID

Electronic hygrotherm



NSYCCOHT30VID

- Internal sensor element: Temperature sensor and humidity sensor
- Connection: 2 x 2.5 mm² (input voltage) + 2 relays (2 x 2.5 mm² + 2 x 2.5 mm²)
- Hysteresis: Programmed 2 K and 3%
- Temperature setting range: -40°C (-40°F) ...+ 80°C (176°F)
- Humidity setting range: 20%...80%

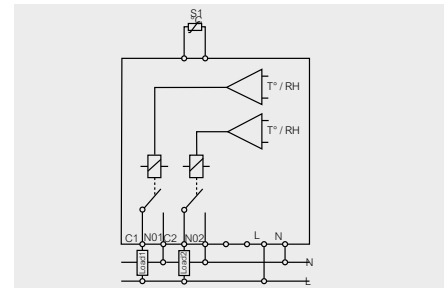

Characteristics	Display	Voltage (type of current)	References
Electronic hygrotherm	°C or °F or % RH	90-140 V (AC)	NSYCCOHT120VID
Electronic hygrotherm	°C or °F or % RH	200-240 V (AC)	NSYCCOHT230VID

Electronic hygrostat



NSYCCOHT230VID

- Internal sensor element: Humidity sensor
- Connection: 2 x 2.5 mm² (input voltage) + 1 relay (2 x 2.5 mm²)
- Hysteresis: 3%
- Humidity setting range: 20%...80%

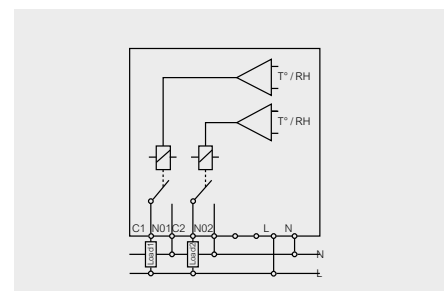

Characteristics	Display	Voltage (type of current)	References
Electronic hygrostat	% RH	200-240 V (AC)	NSYCCOHT230VID

External temperature sensor (double insulation)



NSYCCASTE

Sensor operation or reading range: -40°C (-40°F) ...+ 150°C (302°F), Thermostat installation tips: The thermostat should be installed at the top of the enclosure (the hottest place). See the various operating modes of each thermostat to choose the one that best meets your needs. Hygrostat installation tips: The hygrostat should be installed at the bottom of the enclosure. 60% RH is the optimal value in the enclosure.

- Ingress protection rating: IP67
- Fixing: On DIN rail, on Spacial SF profile, on VDI cross-rail, on mounting plate

Characteristics	Length of cable supplied	References
External temperature sensor	3 m	NSYCCASTE

Thermal conditions: A hot topic for enclosures

Temperature, humidity, and dew point all affect the performance of your electrical and electronic enclosures. Problem is, unless these environments are sized properly, thermal conditions will compromise reliability, safety, and efficiency, as well as the lifetime of your panels.

The precise knowledge of the thermal conditions is therefore indispensable to choose the most appropriate thermal management solution.

Threats to performance arise when:



Real environmental conditions are not known



Specifications are oversized



Excessive loads over-consume energy

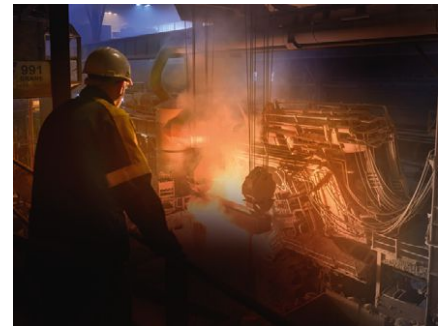

How to use ClimaSys DT

Installation type	Need	What do you want to do?	
Greenfield		New Project	Determine enclosure sizing needs and the correct thermal solution
Brownfield		Power Dissipation verification	Measure the dissipation power of the installation in watts (enclosure without thermal solution installed)
Brownfield		Electronics Health Test	Verify that there are no hot/cold spots
Brownfield		Thermal Solution Test	Measure the efficiency of the existing thermal solution in a certain period of time
Brownfield		Humidity/Condensation Test	Measure the risk of high humidity or condensation inside the enclosure

ClimaSys DT (Diagnostic Tools) dataloggers are an easy-to-use solution that enables users to:

- Access accurate and reliable thermal measurement data in design, commissioning, and exploitation phases
- Track fast or slow measurements
- Maintain continuity of service
- Optimize installations
- Detect hot and cold spots, and avoid condensation problems
- Determine if airing/cooling is required.



ClimaSys DTT

- ClimaSys DT model records the temperature.

Advantages



ClimaSys DTT

- Time stamp/start/stop with magnet key
- Low power consumption for extended two-year battery life
- Easy data download to PC via USB connection
- USB firmware update
- QR code on dataloggers for easy online access to data sheets, videos, and other technical information

Download ProClima free software



e-brochure



Get maximum control panel performance and reliability
Thermal management solutions for critical electrical and electronic enclosures **UE16MK06EN**

Dataloggers

- Color: Translucid
- Display Type: LCD display
- Operating temperature: -40°C (-40°F) ... 80°C (176°F)
- Standard: EN 12830
- Declaration: CE
- Fixing mode: Clip-on support
- Connector type: USB
- Data recording: 32 K
- Temperature Setting (Accuracy): -40°C (-40°F) ... 80°C (176°F) (± 0.3°C (0.54°F))
- Battery Type (Lifespan): Lithium CR2032 3 V (Maximum 2 years)
- Composition: 1

Temperature recorder, DT

- Ingress protection rating according to IEC 60529: IP67



NSYDTEF32T

Characteristics	Temperature Resolution	Dimensions (H x W x D) mm (in.)	References
Temperature recorder	0.03°C (0.05°F)	111 (4.37) x 32 (1.26) x 26 (1.02)	NSYDTEF32T

IMPORTANT NOTICE:







In 2022, the ClimaSys datalogger offer and data upload to Proclima will evolve and will be simplified for a better user experience.

Method to determine a thermal management solution

Here is a simple method to help you choose a thermal solution.
This method does not take into account the humidity level outside the enclosure.

Thermal balance

1 - Characteristics of the enclosure

Position of the enclosure according to IEC 890 ratio		Formula for calculating S (m ²)	Example Spatial reference NSYSF20840
	Accessible from every side	$S = 1.8 \times H \times (W + D) + 1.4 \times W \times D$	Height = 2000 (78.74) mm (in.) Width = 800 (31.50) mm (in.) Depth = 400 (15.75) mm (in.) Installation method: Suitable enclosure placed against a wall. S = 4.128 m²
	Placed against a wall	$S = 1.4 \times W \times (H + D) + 1.8 \times D \times H$	
	On the end when suited	$S = 1.4 \times D \times (H + W) + 1.8 \times W \times H$	
	On the end when suited, placed against a wall	$S = 1.4 \times H \times (W + D) + 1.4 \times W \times D$	
	In the middle when suited	$S = 1.8 \times W \times H + 1.4 \times W \times D + D \times H$	
	In the middle when suited, placed against a wall	$S = 1.4 \times W \times (H + D) + D \times H$	
	In the middle when suited, placed against a wall with the top covered	$S = 1.4 \times W \times H + 0.7 \times W \times D + D \times H$	
		S = m²	

2 - Thermal power dissipated by the operational components

Calculated as the sum of the power dissipated by each of the installed components. If these are not known, use the ProClima software.	Pd = W	Assume that the switchgear dissipates 800 W. Pd = 800 W
--	---------------	---

3 - Temperatures outside the enclosure

		The temperature conditions are as follows:
Maximum ambient temperature.	Te_{max} = °C	Te_{max} = 35°C (95°F)
Minimum ambient temperature.	Te_{min} = °C	Te_{min} = 15°C (59°F)

4 - Average target internal temperatures

They are defined by the nature of the components and the parameters of the ambient air		
Maximum internal temperature	Tid_{max} = °C	Tid_{max} = 40°C (104°F)
Minimum internal temperature (maximum value between dew point temperature and minimum operating temperature of the devices)	Tid_{min} = °C	Tid_{min} = 29°C (84°F)

5 - Temperature inside the enclosure without thermal management system

Max. internal temperature: $Tfi_{max} = \frac{Pd}{K \times S} \times Te_{max}$	Tfi_{max} = °C	Tfi_{max} = 70°C (158°F)
Min. internal temperature: $Tfi_{min} = \frac{Pd}{K \times S} \times Te_{min}$	Tfi_{min} = °C	Tfi_{min} = 50°C (122°F)
or K = 5.5 W/m ² /°C for an enclosure made of painted sheet steel K = 3.5 W/m ² /°C for a polyester enclosure K = 3.7 W/m ² /°C for a stainless-steel enclosure		

Calculation of thermal management power (Psyst)

a. Cooling systems:

$$Psyst = Pd - K \times S (Tid_{max} - Te_{max}) = 686 \text{ w}$$

b. Resistances:

$$Psyst = K \times S (Tid_{min} - Te_{min}) - Pd$$

$$Psyst = K \times S (Tid_{min} - Te_{min})$$

Technical changes reserved. Information provided without guarantee. Images are for illustrative purposes only.

Method to determine a thermal management solution

Choice of solution

1 - Cooling Condition: Calculated temperature + 5°C (41°F) > target temperature

Conditions Cooling	Solution	Advantages	Constraints
Target temperature in the enclosure at least 5°C (41°F) higher than the ambient temperature $Tid_{max} \geq T_{emin} + 5^\circ C (41^\circ F)$	Enlarge the enclosure.	Economical. No maintenance. Easy to implement. IP of the installation maintained.	Relatively small savings. Larger overall dimensions.
	Natural airing (installation of airing air inlets).	Very economical. No maintenance. Easy, fast installation.	Quantity of heat removed small and dependent on the layout of the components. Degradation of the IP (ingress of dust).
	Forced airing.	Economical. Easy to implement. Large quantity of heat removed. Temperature control possible.	Regular maintenance of filters IP slightly degraded. Ambient temperature $\leq 35^\circ C (95^\circ F)$
	Air-to-air exchanger.	Easy to implement. Easy to maintain. IP of the installation maintained. Regulated temperature.	Regular filter maintenance.
Target temperature Tid_{max} in the enclosure 5°C (41°F) less than the ambient temperature Te_{max} . $Tid_{max} - 5^\circ C (23^\circ F) \geq Te_{max}$	Cooling unit.	Easy to implement. Large quantity of heat removed irrespective of the ambient temperature. IP of the installation maintained. Regulated temperature.	Regular filter maintenance Ambient temperature $\leq 55^\circ C (131^\circ F)$ Installation of a system for removal of condensation water from the evaporator.
	Air-to-water exchanger.	Easy to implement. Large quantity of heat removed irrespective of the ambient temperature. IP of the installation maintained. Regulated temperature. No filter to be maintained.	Need for a water circuit. Consumption if supplied with town water.

$$\text{Flow rate (m}^3/\text{h)} = \varnothing = \frac{Ps_{\text{yst}}}{(Tid_{\text{max}} - Te_{\text{max}})} \times 3.1 \text{ (m}^3/\text{h)}$$

$$\text{Flow rate (W/K)} = \varnothing = \frac{Ps_{\text{yst}}}{(Tid_{\text{max}} - Te_{\text{max}})} \text{ (W/K)}$$

2 - Heating

If the calculated temperature is less than the target temperature, the inside of the enclosure must be heated. The solution is to use heating resistors.

They can maintain the temperature above the dew point and thus help prevent any risk of condensation.

To maintain a uniform temperature inside the enclosure and thus help prevent hot spots, Schneider Electric proposes a heating resistor equipped with a fan.

3 - Homogenize

Objective: Prevent hot spots.

Solution: Circulation fan.

Technical Guides and Spare Parts

Introduction

Enclosures and thermal management systems certifications	506
International enclosure standard	507
Selection of enclosures	509
Degrees of protection provided by enclosures	510
Classification of electrical equipment enclosures according to NEMA and UL	511
Polyester base painting properties	513
Properties of the plastic materials	515
Description of the marking label affixed to ATEX certified wall-mounted enclosures	517
Spare parts - Selection table	518
Spare parts ClimaSys	528

Enclosures and Thermal Management Systems Certifications

Range	Empty assemblies					Equipped assemblies
	Empty assemblies for low-voltage switchgear	Standards for industrial equipment and UL classification	Marine environment classification or approval for protection and resistance to vibrations	Enclosures installed in a potentially explosive atmosphere	Outdoor heavy-duty enclosures	Low-voltage switchgear and controlgear assemblies
	Standard/Directive					
	IEC 62208	UL508A and CAN CSA C22-2 no. 14	Compliance with requirements of certified bodies	European directive no. 2014/34/UE EN60079-0 / EN60079-7 EN60079-3 / EN60529	IEC 61439-5 ISO 12944-6 IEC 61969-3	IEC61439-1&2
Spacial						
SBM	●	●	● ●			
S3D	● ● ⁽⁶⁾	●	● ● ●			
CRN	● ⁽⁶⁾	●	●			
CRNG	● ⁽⁶⁾	●	●			
S3DEX		●		●		
S3HF		●				
S3HD	● ⁽⁶⁾	●			●	
S3CM		●				
SM	● ● ⁽⁶⁾	●	●			
SF	● ● ⁽⁶⁾	●	● ●			●
SFHD	● ● ⁽⁶⁾	●			●	●
PrismaSeT HD	● ⁽⁶⁾					●
SFM		●				●
SBX	●	●	●			
S3X	●	●	●			
SMX	●	●	●	● ⁽³⁾		
SFX	● ⁽³⁾	●	●	● ⁽³⁾		
Thalassa						
TBS/TBP	●	● ⁽¹⁾				
PLS	●	●				
PLM	● ● ⁽⁶⁾	●	●	●		
PLA	● ● ⁽⁶⁾	●	●	●		
PLAT	● ● ⁽⁶⁾					
PLAZ	● ● ⁽⁶⁾					
PLAZT	● ● ⁽⁶⁾					
PLD						
PHD	● ⁽⁶⁾				● ⁽²⁾	
ClimaSys⁽⁴⁾						
CV		●				
CU		●				
CE		●				
CR		● ⁽⁵⁾				
CC		●				

⁽¹⁾ Only TBP.

⁽²⁾ ISO 12944-6 only applies to the Spacial enclosures.

⁽³⁾ Only for single-door versions

⁽⁴⁾ EAC-compliant

⁽⁵⁾ The insulated and aluminum resistance heaters of 12-24 V DC and 270-420 V AC are not certified

⁽⁶⁾ Certificate by DEKRA

For other certifications and declarations of conformity please consult us.

Official certification body

Bureau Veritas	LCIE (Bureau Veritas)	Bureau Veritas Marine Division	TUV Rheinland Group	Underwriters Laboratories	Laboratorio Oficial J.M. Madariaga	DNV-GL	Lloyd's Register	Dekra	Asefa
●	●	●	●	●	●	●	●	●	●

Technical changes reserved. Information provided without guarantee. Images are for illustrative purposes only.

The main 10 functions of standard IEC 61439

For each of the following 10 functions, the standard IEC 61439 requires design verifications from the system manufacturer - mainly through type-tests defined in IEC 62208 - and routine verifications on each panel from the panel builder to achieve 3 basic goals: Safety, continuity of service and compliance with end-user requirements.



Safety

Voltage stresses withstand capability

- To withstand long term voltages, and transient and temporary overvoltages according to the insulation coordination principles and requirements.

Current-carrying capability

To help protect against fire and to withstand temperature rise:

- When any circuit is continuously loaded, alone, to the specified current
- When the assembly is loaded to the specified current according to the specified load pattern (between circuits and/or as a function of the time).

Short-circuit withstand capability

- To withstand the stresses resulting from the prospective short-circuit current and from the associated data (high forces between conductors, temp. rise in a very short time, air ionization, overpressure).

Protection against electric shock

- Hazardous live parts not to be accessible (basic protection).
- Accessible conductive parts not to become hazardous-live (fault protection).

Protection against risk of fire or explosion

- Resistance to internal glowing elements.

Comment: Protection of persons, and optional protection of the assembly, against arcing due to internal fault can be specified through a "special test" according to IEC 61641.



Continuity of service

Maintenance and modification capability

Capability to preserve continuity of supply without impairing safety during assembly, maintenance or modification.

- Electrical condition of the assembly or various circuits.
- Speed of exchange of the functional units.
- Test facilities...

Electro-Magnetic Compatibility

To properly function (immunity) and not to generate EM interference (emission) in specified environmental conditions:

- Industrial networks or locations (Environment A).
- Domestic, commercial, and light industrial locations (Environment B).



Compliance with end-user requirements

Capability to operate the electrical installation

To properly function, according to:

- The electrical diagram of the overall system and related information (voltages, coordination...),
- The specified operating facilities (e.g. free or restricted access to man-machine interfaces, isolation of the outgoing circuits...).

Capability to be installed on site

- To withstand handling, transport, storage and installation constraints.
- Capability to be set up and connected (type of enclosure, type, material and cross-sectional areas of external conductors).

Protection of the assembly against mechanical and atmospheric ambient conditions

- Presence of water or solid foreign bodies (IP according to IEC 60529).
- External mechanical impacts (optional IK according to IEC 62262).
- Indoor or outdoor installation (humidity, UV).

Both the point of arrival of energy and a device for distribution to the site applications, the LV switchboard is the intelligence of the system, central to the electrical installation.

It plays an essential role in the availability of electric power, while meeting the needs of personal and property safety. Its definition, design and installation are based on precise rules; There is no space for improvisation. The IEC 61439 standard aims to better define "low-voltage switchgear and controlgear assemblies", helping ensure that the specified performances are reached. It specifies in particular:

- The responsibilities of each player, distinguishing those of the original equipment manufacturer; the organization that performed the original design and associated verification of an assembly in accordance with the standard, and of the assembly manufacturer - the organization taking responsibility for the finished assembly
- The design and verification rules, constituting a benchmark for product certification All the component parts of the electrical switchboard are concerned by the IEC 61439 standard. Equipment produced in accordance with the requirements of this switchboard standard helps ensure the safety and reliability of the installation.

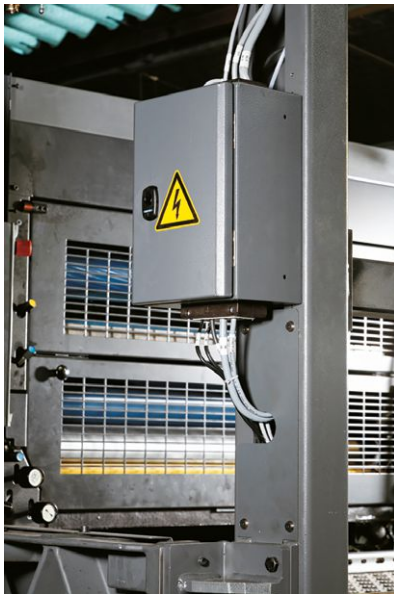

Empty enclosures for low-voltage switchgear and controlgear assemblies. General rules.

Application

For empty enclosures before adding the user's switchgear, in the condition as supplied by the manufacturer.

Field of application

Demands for testing the enclosures to be used as part of the switchgear assemblies for voltages of less than 1000 V alternating current and 1500 V direct current in accordance with IEC 61439.

Information supplied by the manufacturer

- Commercial trademark of the manufacturer: Schneider Electric.
- Mechanical characteristics, materials, conditions for use.
- Conditions for use: Ambient air temperature for outdoor installations: -25°C (-13°F) to + 40°C (104°F)
- Atmospheric conditions for outdoor installations: The humidity may temporarily reach 100% at a temperature of 25°C (77°F)
- Transport and storage conditions: From -25°C (-13°F) to +55°C (131°F); For limited periods not exceeding 24 h: Up to 70°C (158°F)

Comment:

European standard EN 62208 is identical to IEC 62208. European countries publish this standard according to the body in each country (for example BS EN 62208 in the UK).



Standard tests of standard IEC 62208

- Static loads: Test 1.25 x maximum admissible load during 1 hour.
- Lifting: Applicable to enclosures with lifting accessories.
- Axial loads of metal inserts: 500 N for 10 seconds for M8 inserts.
- IK code: Test according to standard IEC 62262 with pendulum impact tester. The enclosure must maintain its IP rating after the test.
- IP rating: Test according to standard IEC 60529. Degree of protection against access to dangerous parts and the penetration of solid bodies and against the penetration of water.
- Thermal stability at a temperature of 70°C (158°F) 7 days.
- Resistance to heat: Ball test at 70°C (158°F)
Information required for enclosures made from insulated material.
- Resistance to abnormal heat and to fire: Glow wire test according to IEC 60695-2-10 and IEC 60695-2-11.
Information required for enclosures made from insulated material.
- Dielectric strength: 5000 V
Information required for enclosures made from insulated material.
- Protection circuit continuity for metal enclosures: Resistance not to exceed 0.1 ohm.
- Weather resistance: Duration 500 h (cycle: Rain 5 minutes + UV lamp 25 minutes).

Corrosion resistance:

For indoor enclosures:

- 6 cycles of 24 hours of the damp heat test at 40°C (104°F) and relative humidity of 95%.
- 2 cycles of 24 hours of the salt mist test at 35°C (95°F)

For outdoor enclosures:

2 identical 12 day periods. Each one with:

- 5 cycles of 24 hours of the damp heat test at 40°C (104°F) and relative humidity of 95%.
- 7 cycles of 24 hours of the salt mist test at 35°C (95°F)

Our empty enclosures are CE-marked according to the Low-Voltage Directive (LVD). It is the responsibility of the final equipment manufacturer to respect regulations in force.

Selection according to the IP protection degrees

The degrees of protection, explained on the next page, is an important element when selecting the enclosures. The following table shows the protection degrees of the enclosures.

Name	Range	IP43	IP44	IP54	IP55	IP65 ⁽⁷⁾	IP66
Metal industrial boxes	Spacial SBM						●
Metal derivation boxes	Spacial SDB				●		
Steel wall-mounted enclosures	Spacial S3DC				● ⁽¹⁾		●
Steel modular distribution wall-mounted enclosures	Spacial S3DM						●
Terminal wall-mounted enclosures	Spacial S3DB						●
Steel wall-mounted enclosures	Spacial S3HF				●		
Steel wall-mounted enclosures	Spacial CRN						●
Steel wall-mounted enclosures	Spacial CRNG				● ⁽¹⁾		●
EMC steel floor-standing enclosures	Spacial SFHF				●		
HMI control enclosures	Spacial S3CM			●			
ATEX steel wall-mounted enclosures	Spacial S3DEX						●
Steel outdoor wall-mounted enclosures	Spacial S3HD						●
Stainless-steel wall-mounted enclosures	Spacial S3X				● ⁽¹⁾		●
Seismic and nuclear enclosures	Spacial S3D6G / Spacial S3D6GK3					●	
Terminal enclosures with FL21 cut-out	Spacial S3DBFL					● ⁽⁶⁾	
Steel floor-standing enclosures	Spacial SM				●		
Steel suitable enclosures	Spacial SF				●		
Steel outdoor floor-standing enclosures	Spacial SFHD				●		
Stainless-steel floor-standing enclosures	Spacial SMX						● ⁽⁷⁾
Stainless-steel suitable enclosures	Spacial SFX						● ⁽⁷⁾
Functional steel floor-standing enclosures	Spacial SFP				●		
Steel control desks	Spacial SD				●		
Stainless-steel control desks	Spacial SDX				●		
Thermoplastic industrial boxes	Thalassa TBS-TBP				● ⁽⁴⁾		● ⁽⁵⁾
Polyester modular boxes	Thalassa PLS						●
Polyester wall-mounted enclosures	Thalassa PLM						●
Polyester outdoor wall-mounted enclosures	Thalassa PHD					●	
Polyester floor-standing enclosures	Thalassa PLA ⁽²⁾		●	●		●	
Polyester floor-standing enclosures	Thalassa PLD	●		● ⁽³⁾			
Polyester outdoor floor-standing enclosures	Thalassa PHD				●		

⁽¹⁾ Double-door.

⁽²⁾ Different IP depending on the version. See introduction in Thalassa section: PLA: IP65, PLAT / PLAZT: IP44, PLAZ / PLAT / PLAZT with grille: IP54.

⁽³⁾ With gasket.

⁽⁴⁾ Button boxes.

⁽⁵⁾ Universal boxes.

⁽⁶⁾ With membrane mounted.

⁽⁷⁾ Single-door enclosure.

The universal offer

> **3** Material options

Steel

Stainless-steel

Plastic and Polyester

Selection according to ambient conditions

The location of the enclosures and the physical, chemical and climatic conditions to which they are exposed will determine the model to be used.

- Steel enclosures are particularly well suited to indoor use in industrial environments.
- Stainless-steel enclosures are particularly well suited to corrosive environments or areas where specific hygiene demands are applicable.
- Polyester enclosures are particularly well suited to severe corrosive atmospheres, indoors or outdoors.

























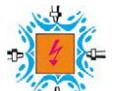

Enclosures made from insulated materials ensure total insulation, reducing electric hazards for persons.

The main characteristics of the plastic materials of our enclosures and their chemical strength are given on [page 515](#).

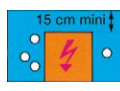
Further help for making the selection is given by the NEMA or UL classification of the enclosure, see [page 512](#).

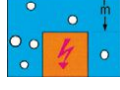
- The degrees of protection provided by the enclosures are defined by standards IEC 60529 (IP) and IEC 62262 (IK).
- Degrees of protection are indicated by the letters IP followed by two characteristic numerals. The numerals show the degree of protection offered by the enclosure against access to hazardous parts, the penetration by solid bodies (1st numeral), and against the penetration of liquids (2nd numeral).
- The protection against external mechanical impact is indicated by the letters IK followed by a characteristic group numeral.

Comment:
 Many EN European standards are harmonized with international IEC standards.
 This is the case with enclosure protection standards:
 - EN 60529 = IEC 60529.
 - EN 62262 = IEC 62262.

	IP	IK
First numeral Protection against solid bodies	Second numeral Protection against liquids	Mechanical protection
<p>0 </p> <p>No protection</p>	<p>0 </p> <p>No protection</p>	<p>0 </p> <p>No protection</p>
<p>1 </p> <p>Protected against solid bodies larger than 50 (1.97) mm (in.) (e.g.: Incidental contact with the hand)</p>	<p>1 </p> <p>Protected against vertically falling water droplets (condensation)</p>	<p>1 </p> <p>Impact energy: 0.150 Joules</p>
<p>2 </p> <p>Protected against solid bodies larger than 12 (0.47) mm (in.) (e.g.: Finger contact)</p>	<p>2 </p> <p>Protected against water droplets deflected at up to 15° from vertical</p>	<p>2 </p> <p>Impact energy: 0.200 Joules</p>
<p>3 </p> <p>Protected against solid bodies larger than 2.5 (0.10) mm (in.) (tools, cables)</p>	<p>3 </p> <p>Protected against rainwater at up to 60° from vertical</p>	<p>3 </p> <p>Impact energy: 0.350 Joules</p>
<p>4 </p> <p>Protected against solid bodies larger than 1 (0.04) mm (in.) (fine tools, small cables)</p>	<p>4 </p> <p>△ Protection against water spray from all directions</p>	<p>4 </p> <p>Impact energy: 0.500 Joules</p>
<p>5 </p> <p>◆ Protected against dust (no harmful deposits)</p>	<p>5 </p> <p>△△ Protected against low-pressure water jets from all directions</p>	<p>5 </p> <p>Impact energy: 0.700 Joules</p>
<p>6 </p> <p>◆ Totally dust tight</p>	<p>6 </p> <p>Protected against powerful water jets from all directions</p>	<p>6 </p> <p>Impact energy: 1.00 Joules</p>
	<p>7 </p> <p>⋯ Protected against the effects of immersion</p>	<p>7 </p> <p>Impact energy: 2.00 Joules</p>
	<p>8 </p> <p>⋯... m Protected against prolonged effects of immersion under pressure</p>	<p>8 </p> <p>Impact energy: 5.00 Joules</p>
		<p>9 </p> <p>Impact energy: 10.00 Joules</p>
		<p>10 </p> <p>Impact energy: 20.00 Joules</p>

Classification of electrical equipment enclosures according to NEMA and UL

NEMA and UL are standardisation bodies, commonly recognized in North America, which have issued classifications of enclosures according to the protection offered in various environments.

These classifications are similar.

The 1st table below summarises these classifications which do not include potentially explosive areas.

The detailed recommendations of these classifications are given on the next page.

The 2nd table indicates the classification of our enclosures.

These classifications appear in our UL certifications (see Certification technical annex on page 512).

Certification according to the UL classification helps guarantee the corresponding NEMA classification by equivalence.

Environment and protection	Classification												
	1	2	3	3R	3S	4	4X	5	6	6P	12	13	
Indoor use	●	●	●	●	●	●	●	●	●	●	●	●	●
Outdoor use			●	●	●	●	●		●				
Incidental contact with the equipment	●	●	●	●	●	●	●	●	●	●	●	●	●
Dirt	●	●	●	●	●	●	●	●	●	●	●	●	●
Drips and gentle splashes of non-corrosive liquids		●	●	●	●	●	●	●	●	●	●	●	●
Rain, frost* and snow			●	●	●	●	●		●	●			
Frost**					●								
Dust, fibers and particles in suspension			●		●	●	●		●	●	●	●	●
Accumulated dust, fibers and particles in suspension			●		●	●	●	●	●	●	●	●	●
Clouds of dust			●		●	●	●		●	●			
Splashes and spray of water						●	●		●	●			
Gentle splashes and leaks of oil or non-corrosive coolants											●	●	
Drips, splashing and spraying of oil or non-corrosive coolants												●	
Corrosive agents							●			●			
Occasional temporary immersion									●	●			
Occasional prolonged immersion										●			

* The operation of the external mechanisms is not required when the enclosure is covered with frost.

** The operation of the external mechanisms is required when the enclosure is covered with frost.

Enclosures		Type of protection ⁽¹⁾													
Name	Range	1	2	3	3R	3S	3X	3RX	3SX	4	4X	5	6	12	13
Metal industrial boxes	SBM									●	●				
HMI control enclosures	S3CM	●	●		●									●	●
Steel wall-mounted enclosures	S3DC ⁽¹⁾	●	● ⁽²⁾	● ⁽²⁾	● ⁽²⁾					● ⁽²⁾	● ⁽²⁾	●		●	●
Steel wall-mounted enclosures	S3HF	●	●	●	●									●	●
Steel outdoor wall-mounted enclosures	S3HD	●	●	●	●					●	●	●		●	●
Steel wall-mounted enclosures	CRN	●	●	●	●					●		●		●	●
Steel wall-mounted enclosures	CRNG	●	● ⁽²⁾	● ⁽²⁾	● ⁽²⁾					● ⁽²⁾	● ⁽²⁾	● ⁽²⁾		●	●
Stainless-steel wall-mounted enclosures	S3X	●	● ⁽²⁾	● ⁽²⁾	● ⁽²⁾					● ⁽²⁾	● ⁽²⁾	● ⁽²⁾		●	● ⁽²⁾
Steel floor-standing enclosures	SM	●	● ⁽²⁾	● ⁽²⁾	●					● ⁽²⁾		● ⁽²⁾		●	●
Polyester outdoor wall-mounted enclosures	PHD	●	●	●	●					● ⁽²⁾	● ⁽²⁾	●		●	●
Steel suitable enclosures	SF	●			●									●	
Steel outdoor floor-standing enclosures	SFHD	●			●									●	
Stainless-steel floor-standing enclosures	SMX	●	● ⁽²⁾	● ⁽²⁾	● ⁽²⁾					● ⁽²⁾	● ⁽²⁾	● ⁽²⁾		●	●
Stainless-steel floor-standing enclosures	SFX	● ⁽²⁾	● ⁽²⁾	● ⁽²⁾	● ⁽²⁾					● ⁽²⁾	● ⁽²⁾	● ⁽²⁾			● ⁽²⁾
Thermoplastic boxes	TBP	●		●		●				●	●				
Polyester modular boxes	PLS	●	●	●	●	●				●	●			●	●
Polyester wall-mounted enclosures	PLM	●	●	●	●	●				●	●	●		●	●
Polyester floor-standing enclosures	PLA	●	●	● ⁽²⁾	● ⁽²⁾	● ⁽²⁾	● ⁽²⁾	● ⁽²⁾	● ⁽²⁾			● ⁽²⁾		●	●

⁽¹⁾ Also S3DM, S3DEX and S3DC.

⁽²⁾ 1 door.

Components		Type of protection ⁽⁵⁾												
Name	Range	1	2	3	3R	3S	4	4X	5	6	6P	12	13	
Airing system	CV											●		
Thermal control system	CC	●												

⁽⁵⁾ In some ranges the classification depends on the model and version. The detailed protection types are indicated in the UL certifications.

Classification of electrical equipment enclosures according to NEMA and UL



Note:

The above recommendations aim to explain the NEMA and UL classifications, but are not the official texts of NEMA or UL. The exact definitions provided by the Organisations are those of standards NEMA 250 and UL 50E.

The enclosures must protect the equipment against environmental conditions and help protect persons against the risk of incidental contact with the equipment. The following classifications (Type) are applied according to the required uses and prescriptions:

Type	Use	Prescription
1	Indoor use	The enclosure provides protection for persons against incidental contact with the internal equipment and protects said equipment against dirt.
2	Indoor use	The enclosure provides protection for persons against incidental contact with the internal equipment and protects said equipment against dirt, drips and gentle splashes of non-corrosive liquids.
3	Indoor and outdoor use	The enclosure provides protection for persons against incidental contact with the internal equipment and protects said equipment against dirt, rain, sleet, snow, windblown and resists the formation of ice on the outside.
3R	Indoor and outdoor use	The enclosure provides protection for persons against incidental contact with the internal equipment and protects said equipment against dirt, rain, sleet, snow and resists the formation of ice on the outside.
3S	Indoor and outdoor use	The enclosure provides protection for persons against incidental contact with the internal equipment and protects said equipment against dirt, rain, sleet, snow and windblown dust. The external mechanism must continue to work even when layers of ice are formed.
3X	Indoor and outdoor use	The enclosure provides a degree of protection to personnel against access to hazardous parts; To provide a degree of protection of the equipment inside the enclosure against ingress of solid foreign objects (falling dirt and windblown dust); To provide a degree of protection with respect to harmful effects on the equipment due to the ingress of water (rain, sleet, snow); To provide an additional level of protection against corrosion and that will be undamaged by the external formation of ice on the enclosure.
3RX	Indoor and outdoor use	The enclosure provides a degree of protection to personnel against access to hazardous parts; To provide a degree of protection of the equipment inside the enclosure against ingress of solid foreign objects (falling dirt); To provide a degree of protection with respect to harmful effects on the equipment due to the ingress of water (rain, sleet, snow); To prevent damage by the external formation of ice on the enclosure and to provide an additional level of protection against corrosion.
3SX	Indoor and outdoor use	The enclosure provides a degree of protection to personnel against access to hazardous parts; To provide a degree of protection of the equipment inside the enclosure against ingress of solid foreign objects (falling dirt and windblown dust); To provide a degree of protection with respect to harmful effects on the equipment due to the ingress of water (rain, sleet, snow); To provide an additional level of protection against corrosion; To ensure that external mechanism(s) remain operable when ice laden.
4	Indoor and outdoor use	The enclosure provides protection for persons against incidental contact with the internal equipment and protects said equipment against dirt, rain, sleet, snow, windblown dust, splashes and hose-directed water and resists the formation of frost on the outside.
4x	Indoor and outdoor use	The enclosure provides protection for persons against incidental contact with the internal equipment and protects said equipment against dirt, rain, sleet, snow, windblown dust, splashes, hose-directed water and resists corrosion and the formation of ice on the outside.
5	Indoor use	The enclosure provides protection for persons against incidental contact with the internal equipment and protects said equipment against dirt, settling airborne dust, lint, fibers, flyings, drips and gentle splashes of non-corrosive liquids.
6	Indoor and outdoor use	The enclosure provides protection for persons against incidental contact with the internal equipment and protects said equipment against dirt, rain, sleet, snow, hose-directed water, the entry of water during occasional temporary submersion to a limited depth and resists the formation of ice on the outside.
6P	Indoor and outdoor use	The enclosure provides protection for persons against incidental contact with the internal equipment and protects said equipment against dirt, rain, sleet, snow, hose-directed water, the entry of water during prolonged submersion to a limited depth and resists corrosion and the formation of ice on the outside.
12	Indoor use (without knock-outs)	The enclosure provides protection for persons against incidental contact with the internal equipment and protects said equipment against dirt, dust, fluff, fibers, particles in suspension, drips and gentle splashes of non-corrosive liquids as well as gentle splashes or leaks of oil and non-corrosive coolants.
13	Indoor use	The enclosure provides protection for persons against incidental contact with the internal equipment and protects said equipment against dirt, dust, lint, fibers flyings and the spraying, splashing, and seepage leaks of water, oil or non-corrosive coolants.

Polyester base-painting properties



Product type

Thermosetting polyester resins based powder painting modified by epoxy resins and designed for decoration and to help prevent corrosion.
The performance of this coating is superior to conventional epoxy powders in terms of color stability, temperature resistance and weather resistance.
RAL 7035 grey; Surface finish: Structured.

Mechanical properties

Testing conditions: Steel samples with a thickness of 10 (0.39)/10^e mm (in.).
Degreasing using biodegradable surface-active agents.
Film thickness: 60 microns.

Test	Standard	Requirement
Bonding (scratching and adhesive tape)	ISO 2409	≥ to Class 1
Ericksen stamping	ISO 1520	≥ 7 (0.28) mm (in.)
Direct impact resistance	ISO 6272	> 1 (2.20) kg (lbs.) / 70 (27.56) cm (in.)
Indirect impact resistance	ISO 6272	> 1 (2.20) kg (lbs.) / 20 (7.87) cm (in.)
Bending around conical mandrel	ISO 6860 - ASTM D 522-88	Maximum cracking of 70 (2.76) mm (in.), without the paint coming loose

Chemical properties

Tests conducted at ambient temperature on phosphated samples covered with a 70 to 100 micron film:

- Film intact.
- Film attacked (blistering, yellowing, loss of gloss).

Number of months		2	4	6	8	10	12	
Acid	Acetic	20%	[Intact]					
	Sulphuric	30%	[Intact]					
	Nitric	30%	[Intact]		[Attacked]			
	Phosphoric	30%	[Intact]					
	Hydrochloric	30%	[Intact]				[Attacked]	
	Lactic	10%	[Intact]					
	Citric	10%	[Intact]				[Attacked]	
Base	Soda	10%	[Intact]		[Attacked]			
	Ammonia	10%	[Intact]		[Attacked]			
Water	Distilled water		[Intact]				[Attacked]	
	Sea water		[Intact]					
	Tap water		[Intact]					
	Diluted chloride bleach		[Intact]		[Attacked]			
Solvents	Petrol		[Intact]		[Attacked]			
	Higher-grade alcohols		[Intact]				[Attacked]	
	Aliphatics		[Intact]		[Attacked]			
	Aromatics		[Intact]		[Attacked]			
	Ketone-ester		[Attacked]					
	Tri-perchlorethylene		[Attacked]					

Physical properties

Temperature resistance: -40°C (-40°F) and 100 hours at + 150°C (302°F) (color: White).
Gloss retention: Good.

Resistance to corrosion

Compliance with standard IEC 62208 for outdoor installations: 288 h of humid heat and 336 h of salt mist.

Polyester base coating properties

Nuclear decontamination

Applicable to colors RAL 7035 grey and AFNOR A550.
Standard NFT 30901. Percentage of decontamination for contamination by fission products. Please consult us for further details.

Accelerated aging

Standard IEC 62208: 500 h UV according to ISO 4892 (method A)
(adherence of the coating with minimum retention of 50% on the grid according to ISO 2409).

Fire behaviour

Class M1 (self-extinguishing material).
Class M0 (for coating on a metal base).

Manufacturing process



Properties of plastic materials - Mechanical, electrical, physical and fire-resistance properties

Plastic materials generally used to manufacture our products:

- ABS.
- Polycarbonate.
- PVC (polyvinyl chloride).
- Bayblend® = PC + ABS.
- Polyester reinforced with fiberglass.
- Altuglas.
- Polypropylene.
- Polystyrene.
- Polyamide 6 and 12.
- SBS.

Comment:

For other chemical agents, please contact us.

All information provided herein is taken from the best sources and provided for information purposes only, with no commitment on our behalf.

Specifications	Standards	Units	ABS	Polycarbonate	PVC	Bayblend®	Polyester	SBS
Mechanical properties								
Tensile strength	ISO 257	MPa	44	> 65	45	35	85	5
Tensile strain	ISO 527	%	12	> 110	120 bis 150	40	0	600
Impact resistance	ISO 179	kJ/m ²	125	No breakage	25	No breakage	60	No breakage
Notching resistance	ISO 179	kJ/m ²	19	25	20	25	50	-
Electrical properties								
Stress point	IEC 60112	-	-	250-300	> 600	> 550	> 600	-
Surface strength	IEC 60093	Ω	1015	> 1015	> 1013	> 1014	≥1012	> 1013
Dielectric strength	IEC 60243	kV/mm	16.5	> 30	30	24	18-20	20
Specific resistivity	IEC 60093	Ω ² cm	1015	> 1016	≥ 1015	1016	≥ 1012	> 1016
Physical properties								
Softening temperature (Vicat B)	ISO 306	°C (°F)	95°C (203°F)	145°C (293°F) - 150°C (302°F)	79°C (174°F) - 80°C (176°F)	115°C (239°F)	⁽¹⁾	80°C (176°F)
Temperature resistance	-	°C (°F)	-40°C (-40°F) ...+ 90°C (194°F)	-50°C (-58°F) ...+ 125°C (257°F)	-20°C (-4°F) ...+ 65°C (149°F)	-35°C (-31°F) ...+ 90°C (194°F)	-50°C (-58°F) ...+ 150°C (302°F)	-40°C (-40°F) ...+ 120°C (248°F)
Water absorption	ISO 62	%	0.2 - 0.45	0.15	< 0.1	0.2	0.2	-
Specific weight	ISO 1183	kg/dm ³	1.04	1.21	1.4	1.12	1.85	0.3 in 24 h
Fire resistance								
Oxygen index	ISO 4589	%	19	26	45-50	22	24.4	18
Glow wire resistance, 2 (0.08) mm (in.)	IEC 60695-2-10	°C (°F)	650°C (1202°F)	960°C (1760°F)	960°C (1760°F)	750°C (1382°F)	960°C (1760°F)	750°C (1382°F) (1.5 (0.06) mm (in.))
Glow wire resistance, 3 (0.12) mm (in.)	IEC 60695-2-10	°C (°F)	650°C (1202°F)	960°C (1760°F)	960°C (1760°F)	750°C (1382°F)	960°C (1760°F)	NA

⁽¹⁾No softening of the polyester.

Specifications	Standards	Units	Altuglas	Polypropylene	Polystyrene	Polyamide 6	Polyamide 12
Mechanical properties							
Tensile strength	ISO 257	MPa	30	35	24	40	30
Tensile strain	ISO 527	%	5	400	36	200	300
Impact resistance	ISO 179	kJ/m ²	20	20	63	No breakage	No breakage
Notching resistance	ISO 179	kJ/m ²	3	5	50	31.2	15
Electrical properties							
Stress point	IEC 60112	-	-	-	KB175	KB175	KB180
Surface strength	IEC 60093	Ω	≥ 1014	-	> 1013	1012	5 x 1010
Dielectric strength	IEC 60243	kV/mm	13-15	20	≤ 40	23	55
Specific resistivity	IEC 60093	Ω ² cm	> 1015	> 1016	> 1015	1011	3 x 1011
Physical properties							
Softening temperature (Vicat B)	ISO 306	°C (°F)	120°C (248°F) - 122°C (252°F)	75°C (167°F) (vicat A)	79°C (174°F)	230°C (446°F)	140°C (284°F)
Temperature resistance	-	°C (°F)	-20°C (-4°F) ...+ 80°C (176°F)	-10°C (14°F) ...+ 80°C (176°F)	-15°C (5°F) ...+ 60°C (140°F)	-20°C (-4°F) ...+ 100°C (212°F)	-50°C (-58°F) ...+ 125°C (257°F)
Water absorption	ISO 62	%	< 0.5	0.1 in 24 h	0.1 in 24 h	1.6	1.5
Density	ISO 1183	kg/dm ³	1.18	0.91	1.06	1.14	1.03
Fire resistance							
Oxygen index	ISO 4589	%	18.5	18	18	24	22
Glow wire resistance, 2 (0.08) mm (in.)	IEC 60695-2-10	°C (°F)	-	650°C (1202°F)	650°C (1202°F)	750°C (1382°F)	650°C (1202°F)
Glow wire resistance, 3 (0.12) mm (in.)	IEC 60695-2-10	°C (°F)	960°C (1760°F)	650°C (1202°F)	650°C (1202°F)	850°C (1562°F)	650°C (1202°F)

Properties of plastic materials - Resistance to chemical agents

Plastic materials generally used to manufacture our products:

- ABS.
- Polycarbonate.
- PVC (polyvinyl chloride).
- Bayblend® = PC + ABS.
- Polyester.
- Altuglas.
- Polypropylene.
- Polystyrene.
- Polyamide 6 and 12.
- SBS.

The table shows:

The concentration of the chemical agent in %;

- Sat = saturation.

The resistance of the material:

- +: Resistant.
- O: Limited resistance.
- -: Not resistant.

Resistance to	ABS	Polycarbonate	PVC	Bayblend®	Polyester	Altuglas	Polypropylene	Polystyrene	Polyamide 6	Polyamide 12	SBS											
Acetone	-	-	-	-	-	O	100	+	-	100	+											
Hydrochloric acid	15	+	10	+	30	+	20	+	30	+	sat	+	10	+	O	10	-	10	+	10	+	
Citric acid			10	+	sat	+	10	+	100	+	sat	+	+	10	O			+	+	10	+	
Lactic acid	80	+	10	+	90	+	10	-	100	+	20	+	90	+	O	50	O		+	+	sat	+
															90	-			+			
Nitric acid	30	+	10	+	50	+	10	+	20	+	10	+	25/		O	2	O		-		50	+
			100	-					+	100	-	50			10	-						
Phosphoric acid	85	+	100	+	sat	+		+	100	+	10	+	sat	+	O	2	O	50	+			+
										95	-				10	-						
Sulphuric acid	50	+	50	+	96	+	30	+	70	+	30	+	96	+	O	3	-	10	+		96	+
			100	-																		
Alcohol	O	96	+	96	+		-	50	O	50	O	96	+		+	96	O	96	+			+
Pure aniline	O		-	100	-		-		O		-	100	+			100	O	100	O			
Benzene	+	100	-		-		+		-		O	100	O			100	+		+			-
Liquid bromine		100	-		-		-					100	-					100	-			-
Liquid chlorine			-	100	-			sat	+		-	100	-			100	O		-	50	+	
Sea water	+	100	+	100	+		+	100	+	100	+			100	+			100	+	sat		+
Petrol	+	100	+	100	O		-	100	+	100	O		-		-	100	+		+			-
Ether	-	100	O	100	-		-	100	O		+					100	+	100	+			-
Hexane	O		+		O		O		-			100	+			100	+	100	+			-
Oil and greases	+	100	+	100	+		O	100	+	100	O	100	+		-		+	100	+			-
Aromatic hydrocarbon	O		-		-		-		-		+				-		-		+			-
Fuel oil	O	100	O	100	+		-	100	+	100	-	100	+			100	+	100	+			-
Naphthalene				100	O		-	100	+	100	-	100	+			100	+	100	+			-
Nitrobenzene	-		-	100	-		-				-	100	O				-		O			-
Phenol	-		-	sat	O		-	20	O		-	sat	+				-		-	10	O	
Mineral salts			+		+		+		+		+		+						+			+
Iodine solution			O		-		+				-						+					
Toluene	-		-	100	-		-		+		O	100	O		-	100	+	100	+			-
Trichloroethylene	-		-	100	-		-		-		-	100	O		-	100	-	100	O			-
Urea			sat	+	sat	+		+				sat	+			10	+	sat	+	sat	O	

Comment:

For other chemical agents please contact us.

All information provided here is taken from the best sources and provided for information purposes only, with no commitment on our behalf.

Description of marking labels on ATEX-certified wall-mounted enclosures

Spacial S3DEX

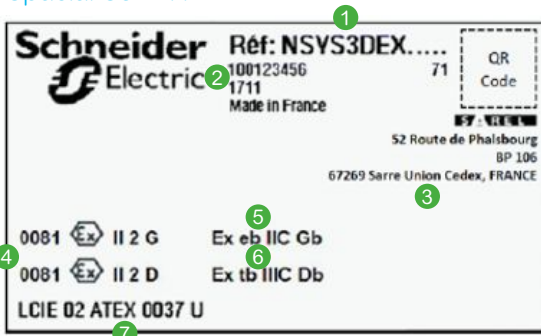

- 1
 - Range of the product with its dimensions
- 2
 - 100123456 71: exemple of the serial number
 - 1711: exemple of the year and the month of the manufacturing
- 3
 - Address of manufacturer
- 4
 - 0081: identification number of the notified body for the application of the ATEX directive
 - : distinctive mark indicating that the product is authorized in an explosive atmosphere
 - II: Industry group (II = surface industries)
 - 2: device category (2 = occasional presence, Zone 1 or 21)
 - G: atmosphere type (G = gases and vapors)
 - D: atmosphere type (D = dust)
- 5
 - Ex: symbol that indicates the product complies with one or several protection modes
 - eb: protection level of type of protection "e" for increased safety (EN 60079-7)
 - II C: group of gaz (hydrogen/acetylene)
 - Gb: type of protection for non-electric material (control of power supply) G = gaz
- 6
 - Ex: symbol indicating that the product complies with one or several protection types
 - tb: protection level of type of protection "t" per enclosure (EN 60079-31)
 - III C: type of dust (conductive dust)
 - Db: type of protection for non-electric material (control of power supply) D = dust
- 7
 - Number of the EC type examination certificate (Included the name of the certification body)



Download our ATEX certificates from our site.

Steel industrial boxes SBM



NSYSBMABS4

Accessories	References
Bag of acces. SBM boxes 4 screws	NSYSBMABS4
Bag of acces. SBM boxes 6 screws	NSYSBMABS6

Steel wall-mounted enclosures S3D



NSYDS3D32

Doors	References	Door accessories	References
Plain door 300 (11.81) x 200 (7.87)	NSYDS3D32	Gasket double-door encl.	NSYGDD
Plain door 300 (11.81) x 250 (9.84)	NSYDS3D325	Set of 5 taps and latches	NSYS3DTL
Plain door 300 (11.81) x 300 (11.81)	NSYDS3D33	Hinge 120°	NSYAEDH120S3D
Plain door 300 (11.81) x 400 (15.75)	NSYDS3D34	Hinge 180°	NSYAEDH180S3D
Plain door 400 (15.75) x 300 (11.81)	NSYDS3D43	Earthing accessories	References
Plain door 400 (15.75) x 400 (15.75)	NSYDS3D44	Set of 500 earthing labels	NSYSWMEL
Plain door 400 (15.75) x 600 (23.62)	NSYDS3D46	Fixing hardware cable gland plate	References
Plain door 500 (19.68) x 300 (11.81)	NSYDS3D53	100 screws	NSYS3DCGSB
Plain door 500 (19.68) x 400 (15.75)	NSYDS3D54	Standard screw bag	NSYS3DCGPSTDSB
Plain door 500 (19.68) x 500 (19.68)	NSYDS3D55	Locking accessories	References
Plain door 600 (23.62) x 400 (15.75)	NSYDS3D64	Set of 10 linkage guides	NSYS3DLG
Plain door 600 (23.62) x 500 (19.68)	NSYDS3D65	Standard key DB3	NSYAEDLS3DKDB3
Plain door 600 (23.62) x 600 (23.62)	NSYDS3D66	Lock + standard key DB3 neutral	NSYAEDLS3DRLN
Plain door 600 (23.62) x 800 (31.50)	NSYDS3D68	3 point lock linkage H 600 (23.62) mm (in.)	NSYBTAS3D60
Plain door 700 (27.56) x 500 (19.68)	NSYDS3D75	3 point lock linkage H 700 (27.56) mm (in.)	NSYBTAS3D70
Plain door 800 (31.50) x 600 (23.62)	NSYDS3D86	3 point lock linkage H 800 (31.50) mm (in.)	NSYBTAS3D80
Plain door 800 (31.50) x 800 (31.50)	NSYDS3D88	3 point lock linkage H 1000 (39.37) mm (in.)	NSYBTAS3D100
Plain door 800 (31.50) x 1000 (39.37)	NSYDS3D810	3 point lock linkage H 1200 (47.24) mm (in.)	NSYBTAS3D120
Plain door 800 (31.50) x 500 (19.68) right	NSYDS3D85R	3 point lock linkage H 1400 (55.12) mm (in.)	NSYBTAS3D140
Plain door 800 (31.50) x 500 (19.68) left	NSYDS3D85L	Lock with key type 3131A	NSYAEDL3131AS3D
Plain door 800 (31.50) x 600 (23.62) right	NSYDS3D86R	3 point lock linkage (H = 650 (25.59) mm (in.))	NSYBTAS3D65
Plain door 800 (31.50) x 600 (23.62) left	NSYDS3D86L	3 point lock linkage (H = 900 (35.43) mm (in.))	NSYBTAS3D90
Plain door 1000 (39.37) x 600 (23.62)	NSYDS3D106	Panels	References
Plain door 1000 (39.37) x 800 (31.50)	NSYDS3D108	50 caps for holes of hinges WM	NSYSWMCH
Plain door 1000 (39.37) x 1000 (39.37)	NSYDS3D1010	Set of 50 back plugs WM	NSYSWMBP
Plain door 1200 (47.24) x 1000 (39.37)	NSYDS3D1210		
Plain door 1000 (39.37) x 500 (19.68) right	NSYDS3D105R		
Plain door 1000 (39.37) x 500 (19.68) left	NSYDS3D105L		
Plain door 1000 (39.37) x 600 (23.62) right	NSYDS3D106R		
Plain door 1000 (39.37) x 600 (23.62) left	NSYDS3D106L		
Plain door 1200 (47.24) x 600 (23.62)	NSYDS3D126		
Plain door 1200 (47.24) x 800 (31.50)	NSYDS3D128		
Plain door 1200 (47.24) x 500 (19.68) right	NSYDS3D125R		
Plain door 1200 (47.24) x 500 (19.68) left	NSYDS3D125L		
Plain door 1200 (47.24) x 600 (23.62) right	NSYDS3D126R		
Plain door 1200 (47.24) x 600 (23.62) left	NSYDS3D126L		
Plain door 1400 (55.12) x 500 (19.68) right	NSYDS3D145R		
Plain door 1400 (55.12) x 500 (19.68) left	NSYDS3D145L		

Steel wall-mounted enclosures S3DM



NSYS3DCGSB

Fixing hardware	References
100 screws for cable gland plate	NSYS3DCGSB
Standard screw bag cable gland plate	NSYS3DCGPSTDSB
Earthing accessories	References
Set of 500 earthing labels	NSYSWMEL
Locking accessories	References
Set of 10 linkage guides	NSYS3DLG
Standard key DB3	NSYAEDLS3DKDB3
3 point lock linkage H 600 (23.62) mm (in.)	NSYBTAS3D60
3 point lock linkage H 700 (27.56) mm (in.)	NSYBTAS3D70
3 point lock linkage H 800 (31.50) mm (in.)	NSYBTAS3D80
3 point lock linkage H 1000 (39.37) mm (in.)	NSYBTAS3D100
Panels WM	References
50 caps for holes of hinges	NSYSWMCH
Set of 50 back plugs	NSYSWMBP

Steel wall-mounted enclosures S3DC



NSYSWMEL

Earthing accessories	References
Set of 500 earthing labels	NSYSWMEL
Locking accessories	References
Set of 10 linkage guides	NSYS3DLG
Standard lock enclosures	NSYAEDLS3DC
3 point lock linkage H 600 (23.62) mm (in.)	NSYBTAS3D60
3 point lock linkage H 700 (27.56) mm (in.)	NSYBTAS3D70
3 point lock linkage H 800 (31.50) mm (in.)	NSYBTAS3D80
3 point lock linkage H 1000 (39.37) mm (in.)	NSYBTAS3D100
3 point lock linkage H 1200 (47.24) mm (in.)	NSYBTAS3D120
Panels WM	References
50 caps for holes of hinges	NSYSWMCH
Set of 50 back plugs	NSYSWMBP

Steel wall-mounted enclosures S3DB



NSYSWMEL

Earthing accessories	References
Set of 500 earthing labels	NSYSWMEL
Locking accessories	References
Standard key DB3	NSYAEDLS3DKDB3
Panels	References
50 caps for holes of hinges WM	NSYSWMCH
Set of 50 back plugs WM	NSYSWMBP

Spare Parts Selection Table

Steel wall-mounted enclosures CRN



NSYDCRN22

Doors mm (in.)	References	Door accessories	References
Plain door H 200 (7.87) x W 200 (7.87)	NSYDCRN22	Standard Spacial hinge	NSYBICRN
Plain door H 200 (7.87) x W 300 (11.81)	NSYDCRN23	Earthing accessories	References
Plain door H 250 (9.84) x W 200 (7.87)	NSYDCRN2520	Set of 500 earthing labels	NSYSWMEL
Plain door H 300 (11.81) x W 250 (9.84)	NSYDCRN3025	Locking accessories	References
Plain door H 300 (11.81) x W 300 (11.81)	NSYDCRN33	TCRE1 Lock	NSYTCRE1
Plain door H 300 (11.81) x W 400 (15.75)	NSYDCRN34	TCRE12 Lock	NSYTCRE12
Plain door H 300 (11.81) x W 450 (17.72)	NSYDCRN3045	Platten	References
Plain door H 400 (15.75) x W 300 (11.81)	NSYDCRN43	Set of 50 back plugs WM	NSYSWMBP
Plain door H 400 (15.75) x W 400 (15.75)	NSYDCRN44	Fixing hardware	References
Plain door H 400 (15.75) x W 600 (23.62)	NSYDCRN46	Screw bag for CRN cable gland plate	NSYCRNCGPSTDSB
Plain door H 500 (19.68) x W 400 (15.75)	NSYDCRN54	Sealing	References
Plain door H 500 (19.68) x W 500 (19.68)	NSYDCRN55	Adhesive sealing gasket 18 x 10 2M	NSYADG2M
Plain door H 600 (23.62) x W 400 (15.75)	NSYDCRN64	Adhesive sealing gasket 18 x 10 3M	NSYADG3M
Plain door H 600 (23.62) x W 500 (19.68)	NSYDCRN65	Adhesive sealing gasket 18 x 10 5M	NSYADG5M
Plain door H 600 (23.62) x W 600 (23.62)	NSYDCRN66	Adhesive sealing gasket 18 x 10 20M	NSYADG20M
Plain door H 600 (23.62) x W 800 (31.50)	NSYDCRN68		
Plain door H 700 (27.56) x W 500 (19.68)	NSYDCRN75		
Plain door H 800 (31.50) x W 600 (23.62)	NSYDCRN86		
Plain door H 800 (31.50) x W 800 (31.50)	NSYDCRN88		
Plain door H 1000 (39.37) x W 600 (23.62)	NSYDCRN106		
Plain door H 1000 (39.37) x W 800 (31.50)	NSYDCRN108		

Steel wall-mounted enclosures CRNG



NSYDCRNG86

Doors mm (in.)	References	Door accessories	References
Plain door H 800 (31.50) x W 600 (23.62)	NSYDCRNG86	Hinge 120°	NSYAEDH120S3D
Plain door left H 800 (31.50) x W 500 (19.68)	NSYDCRNG85L	Hinge 180°	NSYAEDH180S3D
Plain door right H 800 (31.50) x W 500 (19.68)	NSYDCRNG85R	Locking accessories	References
Plain door left H 800 (31.50) x W 600 (23.62)	NSYDCRNG86L	3 point lock linkage for Spacial CRNG (H = 800 (31.50) mm (in.))	NSYBTACRNG80
Plain door right H 800 (31.50) x W 600 (23.62)	NSYDCRNG86R	3 point lock linkage for Spacial CRNG (H = 1000 (39.37) mm (in.))	NSYBTACRNG100
Plain door H 1000 (39.37) x W 600 (23.62)	NSYDCRNG106	3 point lock linkage for Spacial CRNG (H = 1200 (47.24) mm (in.))	NSYBTACRNG120
Plain door H 1000 (39.37) x W 800 (31.50)	NSYDCRNG108	3 point lock linkage for Spacial CRNG (H = 1400 (55.12) mm (in.))	NSYBTACRNG140
Plain door left H 1000 (39.37) x W 500 (19.68)	NSYDCRNG105L	Earthing accessories	References
Plain door right H 1000 (39.37) x W 500 (19.68)	NSYDCRNG105R	Set of 500 earthing labels	NSYSWMEL
Plain door left H 1000 (39.37) x W 600 (23.62)	NSYDCRNG106L	Fixing hardware cable gland plate	References
Plain door right H 1000 (39.37) x W 600 (23.62)	NSYDCRNG106R	100 screws	NSYS3DCGSB
Plain door left H 1000 (39.37) x W 600 (23.62)	NSYDCRNG106L	Standard screw bag	NSYS3DCGPSTDSB
Plain door H 1200 (47.24) x W 600 (23.62)	NSYDCRNG126	Panels	References
Plain door H 1200 (47.24) x W 600 (23.62)	NSYDCRNG126	50 caps for holes of hinges WM	NSYSWMCH
Plain door H 1200 (47.24) x W 800 (31.50)	NSYDCRNG128	Set of 50 back plugs WM	NSYSWMBP
Plain door H 1200 (47.24) x W 800 (31.50)	NSYDCRNG128	Others accessories	References
Plain door right H 1200 (47.24) x W 500 (19.68)	NSYDCRNG125R	Screw bag for CRN cable gland plate	NSYCRNCGPSTDSB
Plain door left H 1200 (47.24) x W 500 (19.68)	NSYDCRNG125L		
Plain door right H 1200 (47.24) x W 500 (19.68)	NSYDCRNG125R		
Plain door left H 1200 (47.24) x W 500 (19.68)	NSYDCRNG125L		
Plain door H 1200 (47.24) x W 600 (23.62)	NSYDCRNG126R		
Plain door left H 1200 (47.24) x W 600 (23.62)	NSYDCRNG126L		
Plain door H 1200 (47.24) x W 600 (23.62)	NSYDCRNG126R		
Plain door left H 1200 (47.24) x W 600 (23.62)	NSYDCRNG126L		
Plain door right H 1400 (55.12) x W 500 (19.68)	NSYDCRNG145R		
Plain door left H 1400 (55.12) x W 500 (19.68)	NSYDCRNG145L		

Steel floor-standing enclosures SF



NSYSFD207

Door accessories	References	Fixing hardware	References
Set of 4 Hinges and fixing elements	NSYDHSF	Captive screws for panels external fixing	NSYCSSF
Double-door stoppers (2 pieces)	NSYDSSF2D	Plinth accessories mm (in.)	References
Locking accessories mm (in.)	References	H 100 (3.94) Plastic covers for plinth corners	NSYPC100
Locking system for enclosures single-door version H 1200 (47.24) mm (in.) (right side door for double-door version)	NSYLCK12SF	H 200 (7.87) Plastic covers for plinth corners	NSYPC200
Locking system for enclosures 1 single-door version H 1400 (55.12) mm (in.)	NSYLCK14SF	Installation accessories mm (in.)	References
Locking system for enclosures single-door version H 1600 (62.99) mm (in.) (right side door for double-door version)	NSYLCK16SF	Set of 2 (0.08) quick cross-rails 120 (4.72) x 400 (15.75)	NSYSQCR12040
Locking system for enclosures single-door version H 1800 (70.87) mm (in.) (right side door for double-door version)	NSYLCK18SF	Set of 2 (0.08) quick cross-rails 120 (4.72) x 500 (19.68)	NSYSQCR12050
Locking system for enclosures single-door version H 2000 (78.74) mm (in.) (right side door for double-door version)	NSYLCK20SF	Set of 2 (0.08) quick cross-rails 120 (4.72) x 600 (23.62)	NSYSQCR12060
Locking system for enclosures single-door version H 2200 (86.61) mm (in.) (right side door for double-door version)	NSYLCK22SF	Set of 2 (0.08) quick cross-rails 120 (4.72) x 800 (31.50)	NSYSQCR12080
Door locking system toothed washer	NSYLCKWSF	Panels mm (in.)	References
Handle neutral trim	NSYSFHNTTRIM	PrismaSet back panel H 2000 (78.74) x W 700 (27.56)	NSYBP207
Handle SF	NSYSFHS1		



NSYRSF35



NSYRSF35L

Roof mm (in.)	New roof (expanded)	Old roof (integrated)	"New roof" accessory	References
Roof W 300 (11.81) x D 500 (19.68)	NSYRSF35L	NSYRSF35	Fixed roof off-center bracket for PrismaSet	NSYRSFBLR
Roof W 300 (11.81) x D 600 (23.62)	NSYRSF36L	NSYRSF36	Fixing elements SF enlarged roof	NSYRSFLFIX
Roof W 300 (11.81) x D 800 (31.50)	NSYRSF38L	NSYRSF38		
Roof W 400 (15.75) x D 400 (15.75)	NSYRSF44L	NSYRSF44		
Roof W 400 (15.75) x D 500 (19.68)	NSYRSF45L	NSYRSF45		
Roof W 600 (23.62) x D 400 (15.75)	NSYRSF64L	NSYRSF64		
Roof W 600 (23.62) x D 500 (19.68)	NSYRSF65L	NSYRSF65		
Roof W 600 (23.62) x D 600 (23.62)	NSYRSF66L	NSYRSF66		
Roof W 800 (31.50) x D 400 (15.75)	NSYRSF84L	NSYRSF84		
Roof W 800 (31.50) x D 500 (19.68)	NSYRSF85L	NSYRSF85		
Roof W 800 (31.50) x D 600 (23.62)	NSYRSF86L	NSYRSF86		
Roof W 800 (31.50) x D 800 (31.50)	NSYRSF88L	NSYRSF88		
Roof W 1000 (39.37) x D 400 (15.75)	NSYRSF104L	NSYRSF104		
Roof W 1000 (39.37) x D 500 (19.68)	NSYRSF105L	NSYRSF105		
Roof W 1000 (39.37) x D 600 (23.62)	NSYRSF106L	NSYRSF106		
Roof W 1000 (39.37) x D 800 (31.50)	NSYRSF108L	NSYRSF108		
Roof W 1200 (47.24) x D 400 (15.75)	NSYRSF124L	NSYRSF124		
Roof W 1200 (47.24) x D 500 (19.68)	NSYRSF125L	NSYRSF125		
Roof W 1200 (47.24) x D 600 (23.62)	NSYRSF126L	NSYRSF126		
Roof W 1200 (47.24) x D 800 (31.50)	NSYRSF128L	NSYRSF128		
Roof W 1600 (62.99) x D 400 (15.75)	NSYRSF164L	NSYRSF164		
Roof W 1600 (62.99) x D 500 (19.68)	NSYRSF165L	NSYRSF165		
Roof W 1600 (62.99) x D 600 (23.62)	NSYRSF166L	NSYRSF166		

Steel floor-standing enclosures SM



NSYSMEC1041

Cable gland plates mm (in.)	References	Door accessories	References
1 (0.04) entry W 1000 (39.37) x D 400 (15.75)	NSYSMEC1041	Set of 4 hinges and fixing elements	NSYDHSF
1 (0.04) entry W 1000 (39.37) x D 300 (11.81)	NSYSMEC1031	Spacial SM hinges and 2D door stop	NSYDHSM2D
1 (0.04) entry W 1000 (39.37) x D 500 (19.68)	NSYSMEC1051	Double-door stoppers (2 pieces)	NSYTDSSF2D
1 (0.04) entry W 600 (23.62) x D 300 (11.81)	NSYSMEC631		
1 (0.04) entry W 600 (23.62) x D 400 (15.75)	NSYSMEC641	Locking accessories mm (in.)	References
1 (0.04) entry W 600 (23.62) x D 500 (19.68)	NSYSMEC651	Locking system for enclosures 1 (0.04) single door version H 1200 (47.24)	NSYLCK12SF
1 (0.04) entry W 600 (23.62) x D 600 (23.62)	NSYSMEC661	(right side door for double-door version)	
1 (0.04) entry W 800 (31.50) x D 300 (11.81)	NSYSMEC831	Locking system for enclosures 1 (0.04) single door version H 1600 (62.99)	NSYLCK16SF
1 (0.04) entry W 800 (31.50) x D 400 (15.75)	NSYSMEC841	(right side door for double-door version)	
1 (0.04) entry W 800 (31.50) x D 500 (19.68)	NSYSMEC851	Locking system for enclosures 1 (0.04) single door version H 1800 (70.87)	NSYLCK18SF
1 (0.04) entry W 800 (31.50) x D 600 (23.62)	NSYSMEC861	(right side door for double-door version)	
	Old roof integrated)	Locking system for enclosures 1 (0.04) single door version H 2000 (78.74)	NSYLCK20SF
Doors mm (in.)		(right side door for double-door version)	
Double plain door H 1200 (47.24) x W 1000 (39.37)	NSYSMD12102D	Locking system for enclosures 1 (0.04) single door version H 2200H	NSYLCK22SF
Double plain door H 1200 (47.24) x W 1200 (47.24)	NSYSMD12122D	(right side door for double-door version)	
Double plain door H 1400 (55.12) x W 1000 (39.37)	NSYSMD14102D	Locking system for enclosures 1 (0.04) single-door version H 1400 (55.12)	NSYLCK14SF
Double plain door H 1400 (55.12) x W 1200 (47.24)	NSYSMD14122D	Door locking system toothed washer	NSYLCKWSF
Double plain door H 1600 (62.99) x W 1000 (39.37)	NSYSMD16102D	Handle neutral trim	NSYSFHNTRIM
Double plain door H 1600 (62.99) x W 1200 (47.24)	NSYSMD16122D		
Double plain door H 1800 (70.87) x W 1600 (62.99)	NSYSMD18162D	Plinth accessories mm (in.)	References
		H 100 (3.94) Plastic covers for plinth corners	NSYPC100
		H 200 (7.87) Plastic covers for plinth corners	NSYPC200

Stainless-steel enclosuresS3X (wall-mounted)



NSYDS3X1010L

Doors mm (in.)	References	Doors mm (in.)	References
Left door 304L H1000 (39.37) x W1000 (39.37)	NSYDS3X1010L	Plain door 316L H400 (15.75) x W600 (23.62)	NSYDS3X46H
Left door 316L H1000 (39.37) x W1000 (39.37)	NSYDS3X1010LH	Plain door 304L H500 (19.68) x W400 (15.75)	NSYDS3X54
Right door 304L H1000 (39.37) x W1000 (39.37)	NSYDS3X1010R	Plain door 316L H500 (19.68) x W400 (15.75)	NSYDS3X54H
Right door 316L H1000 (39.37) x W1000 (39.37)	NSYDS3X1010RH	Plain door 304L H600 (23.62) x W400 (15.75)	NSYDS3X64
Plain door 304L H1000 (39.37) x W800 (31.50)	NSYDS3X108	Plain door 316L H600 (23.62) x W400 (15.75)	NSYDS3X64H
Plain door 316L H1000 (39.37) x W800 (31.50)	NSYDS3X108H	Plain door 304L H600 (23.62) x W600 (23.62)	NSYDS3X66
Left door 304L H1200 (47.24) x W1000 (39.37)	NSYDS3X1210L	Plain door 316L H600 (23.62) x W600 (23.62)	NSYDS3X66H
Left door 316L H1200 (47.24) x W1000 (39.37)	NSYDS3X1210LH	Plain door 304L H700 (27.56) x W500 (19.68)	NSYDS3X75
Right door 304L H1200 (47.24) x W1000 (39.37)	NSYDS3X1210R	Plain door 316L H700 (27.56) x W500 (19.68)	NSYDS3X75H
Right door 316L H1200 (47.24) x W1000 (39.37)	NSYDS3X1210RH	Plain door 304L H800 (31.50) x W600 (23.62)	NSYDS3X86
Plain door 304L H1200 (47.24) x W800 (31.50)	NSYDS3X128	Plain door 316L H800 (31.50) x W600 (23.62)	NSYDS3X86H
Plain door 316L H1200 (47.24) x W800 (31.50)	NSYDS3X128H	Plain door 304L H800 (31.50) x W800 (31.50)	NSYDS3X88
Plain door 304L H300 (11.81) x W200 (7.87)	NSYDS3X32	Plain door 316L H800 (31.50) x W800 (31.50)	NSYDS3X88H
Plain door 304L H300 (11.81) x W250 (9.84)	NSYDS3X325	Transp. door 304L H1000 (39.37) x W800 (31.50)	NSYDS3X108T
Plain door 316L H300 (11.81) x W250 (9.84)	NSYDS3X325H	Transp. door 304L H400 (15.75) x W300 (11.81)	NSYDS3X43T
Plain door 316L H300 (11.81) x W200 (7.87)	NSYDS3X32H	Transp. door 304L H500 (19.68) x W400 (15.75)	NSYDS3X54T
Plain door 304L H300 (11.81) x W300 (11.81)	NSYDS3X33	Transp. door 304L H600 (23.62) x W400 (15.75)	NSYDS3X64T
Plain door 316L H300 (11.81) x W300 (11.81)	NSYDS3X33H	Transp. door 304L H700 (27.56) x W500 (19.68)	NSYDS3X75T
Plain door 304L H400 (15.75) x W300 (11.81)	NSYDS3X43	Transp. door 304L H800 (31.50) x W600 (23.62)	NSYDS3X86T
Plain door 316L H400 (15.75) x W300 (11.81)	NSYDS3X43H	Door accessories	References
Plain door 304L H400 (15.75) x W400 (15.75)	NSYDS3X44	Set of 2 hinges	NSYHS3X
Plain door 316L H400 (15.75) x W400 (15.75)	NSYDS3X44H	Locking accessories mm (in.)	References
Plain door 304L H400 (15.75) x W600 (23.62)	NSYDS3X46	Locking system 1000 (39.37)	NSYLSS3X10
		Locking system 1200 (47.24)	NSYLSS3X12

Stainless-steel enclosuresSMX ((floor-standing)



NSYDSFX1410L

Doors mm (in.)	References	Locking system mm (in.)	References
Left door 304L H1400 (55.12) x W1000 (39.37)	NSYDSFX1410L	Locking system H = 1400 (55.12)	NSYLSSF14
Right door 304L H1400 (55.12) x W1000 (39.37)	NSYDSFX1410R	Locking system H = 1600 (62.99)	NSYLSSF16
Door 304L H1600 (62.99) x W800 (31.50)	NSYDSFX168	Locking system H = 1800 (70.87)	NSYLSSF18
Door 304L H1800 (70.87) x W600 (23.62)	NSYDSFX186	Locking system H = 2000 (78.74)	NSYLSSF20
Left door H1800 (70.87) x W1200 (47.24)	NSYDSFX1812L	Door accessories	References
Left door 316L H1800 (70.87) x W1200 (47.24)	NSYDSFX1812LH	Double-door stoppers (2 pieces)	NSYTDSSF2D
Right door H1800 (70.87) x W1200 (47.24)	NSYDSFX1812R		
Right door 316L H1800 (70.87) x W1200 (47.24)	NSYDSFX1812RH		
Door 304L H1800 (70.87) x W800 (31.50)	NSYDSFX188		
Door 316L H1800 (70.87) x W800 (31.50)	NSYDSFX188H		
Left door 304L H1800 (70.87) x W1600 (62.99)	NSYDSFX1816L		
Left door 316L H1800 (70.87) x W1600 (62.99)	NSYDSFX1816LH		
Right door 304L H1800 (70.87) x W1600 (62.99)	NSYDSFX1816R		
Right door 316L H1800 (70.87) x W1600 (62.99)	NSYDSFX1816RH		
Left door H2000 (78.74) x W1000 (39.37)	NSYDSFX2010L		
Left door 316L H2000 (78.74) x W1000 (39.37)	NSYDSFX2010LH		
Right door H2000 (78.74) x W1000 (39.37)	NSYDSFX2010R		
Right door 316L H2000 (78.74) x W1000 (39.37)	NSYDSFX2010RH		
Door H1800 (70.87) x W800 (31.50)	NSYDSFX206		
Left door H2000 (78.74) x W1200 (47.24)	NSYDSFX2012L		
Left door 316L H2000 (78.74) x W1200 (47.24)	NSYDSFX2012LH		
Right door H2000 (78.74) x W1200 (47.24)	NSYDSFX2012R		
Right door 316L H2000 (78.74) x W1200 (47.24)	NSYDSFX2012RH		
Door H2000 (78.74) x W800 (31.50)	NSYDSFX208		
Left door H2000 (78.74) x W1600 (62.99)	NSYDSFX2016L		
Left door 316L H2000 (78.74) x W1600 (62.99)	NSYDSFX2016LH		
Right door H2000 (78.74) x W1600 (62.99) SMX	NSYDSFX2016R		
Right door 316L H2000 (78.74) x W1600 (62.99)	NSYDSFX2016RH		

Stainless-steel enclosures SFX (floor-standing)



NSYDSFX186

Doors mm (in.)	References	Door accessories	References
Door 304L H1800 (70.87) x W600 (23.62)	NSYDSFX186	Set of 3 hinges	NSYHSMX
Left door H1800 (70.87) x W1200 (47.24)	NSYDSFX1812L	Double-door stoppers (2 pieces)	NSYTDSSF2D
Right door H1800 (70.87) x W1200 (47.24)	NSYDSFX1812R	Locking accessories mm (in.)	
Door 304L H1800 (70.87) x W800 (31.50)	NSYDSFX188	Locking system H = 1400 (55.12)	NSYLSSF14
Left door H2000 (78.74) x W1000 (39.37)	NSYDSFX2010L	Locking system H = 1600 (62.99)	NSYLSSF16
Right door H2000 (78.74) x W1000 (39.37)	NSYDSFX2010R	Locking system H = 1800 (70.87)	NSYLSSF18
Door H1800 (70.87) x W800 (31.50)	NSYDSFX206	Locking system H = 2000 (78.74)	NSYLSSF20
Left door H2000 (78.74) x W1200 (47.24)	NSYDSFX2012L		
Right door H2000 (78.74) x W1200 (47.24)	NSYDSFX2012R		
Door H2000 (78.74) x W800 (31.50)	NSYDSFX208		
Left door H2000 (78.74) x W1600 (62.99)	NSYDSFX2016L		
Right door H2000 (78.74) x W1600 (62.99)	NSYDSFX2016R		

Insulated materials PLA (floor-standing)



NSYDPLA55G

• For RAL 7035		• For RAL 7035	
Doors mm (in.)	References	Doors mm (in.)	References
Door H500 (19.68) x W500 (19.68) Lock handle type. Door opening 120°	NSYDPLA55G	Door H1500 (59.06) x W500 (19.68) Lock handle type. Door opening 180° + Accessory bag 120° hinge	NSYDPLA155HG
Door H500 (19.68) x W750 (29.53) Lock handle type. Door opening 120°	NSYDPLA57G	Door 1500 (59.06) x 750 (29.53) Lock handle type. Door opening 180° + Accessory bag 120° hinge	NSYDPLA157HG
Door H750 (29.53) x W500 (19.68) Lock handle type. Door opening 120°	NSYDPLA75G	Door accessories	
Door H750 (29.53) x W750 (29.53) Lock handle type. Door opening 120°	NSYDPLA77G	One hinge + axe for PLA (120° opening)	NSYAEDPLA004
Door H1000 (39.37) x W500 (19.68) Lock handle type. Door opening 120°	NSYDPLA105G	Kit of axes of door PLAZT (180° opening)	NSYAEDPLA005
Door H1000 (39.37) x W750 (29.53) Lock handle type. Door opening 120°	NSYDPLA107G	Rod guide inside the door PLA (set of 2)	NSYAEDPLA001
Door H1250 (49.21) x W500 (19.68) Lock handle type. Door opening 120°	NSYDPLA125G	Rod guide on 1 door PLA (set of 2)	NSYAEDPLA002G
Door H1250 (49.21) x W750 (29.53) Lock handle type. Door opening 120°	NSYDPLA127G	Rod guide on 2 doors PLA (set of 2)	NSYAEDPLA003G
Door H1500 (59.06) x W500 (19.68) Lock handle type. Door opening 120°	NSYDPLA155G	Fixing hardware mm (in.)	
Door H1500 (59.06) x W750 (29.53) Lock handle type. Door opening 120°	NSYDPLA157G	Acc. bag for 1 (0.04) door H = 50 (1.97) 0- 1000 (39.37)	NSYASPLA001
Door H500 (19.68) x W500 (19.68) Lock handle type. Door opening 180° + Accessory bag 120° hinge	NSYDPLA55HG	Acc. bag for 2 (0.08) doorH = 1250 (49.21) - 1500 (59.06)	NSYASPLA002
Door H500 (19.68) x W750 (29.53) Lock handle type. Door opening 180° + Accessory bag 120° hinge	NSYDPLA57HG	Acc. bag for 2 door	NSYASPLA003
Door H750 (29.53) x W500 (19.68) Lock handle type. Door opening 180° + Accessory bag 120° hinge	NSYDPLA75HG	Locking accessories mm (in.)	
Door H750 (29.53) x W750 (29.53) Lock handle type. Door opening 180° + Accessory bag 120° hinge	NSYDPLA77HG	Handle locking and rods H = 500 (19.68)	NSYVPLA5MG
Door H1000 (39.37) x W500 (19.68) Lock handle type. Door opening 180° + Accessory bag 120° hinge	NSYDPLA105HG	Handle locking and rods H = 750 (29.53)	NSYVPLA7MG
Door H1000 (39.37) x W750 (29.53) Lock handle type. Door opening 180° + Accessory bag 120° hinge	NSYDPLA107HG	Handle locking and rods H = 1000 (39.37)	NSYVPLA10MG
Door H1250 (49.21) x W500 (19.68) Lock handle type. Door opening 180° + Accessory bag 120° hinge	NSYDPLA125HG	Handle locking and rods H = 1250 (49.21)	NSYVPLA12MG
Door H1250 (49.21) x W750 (29.53) Lock handle type. Door opening 180° + Accessory bag 120° hinge	NSYDPLA127HG	Handle locking and rods H = 1500 (59.06)	NSYVPLA15MG

Insulated materials PLM (wall-mounted)



- For RAL 7035

Complete door (door + lock system)	References	Door accessories	References
Door without locking for PLM32	NSYDPLM32G	Door hinge for NSYPLM32	NSYAEDHPLM32
Door without locking for 2 locks PLM3025	NSYDPLM3025G	Door hinge for NSYPLM3025 for 2 locks door	NSYAEDHPLM3025
Door without locking for PLM43	NSYDPLM43G	Door hinge for NSYPLM43 to 86	NSYAEDHPLM
Door without locking for PLM54	NSYDPLM54G	Door hinge for NSYPLM108	NSYAEDHPLM108
Door without locking for PLM64	NSYDPLM64G	Rod guides (4 pieces) for PLM108	NSYAEDPLM108
Door without locking for PLM75	NSYDPLM75G	Fixing hardware	References
Door with locking for PLM86	NSYDPLM86G	Acc. bag NSYPLM32	NSYASPLM32
Door without locking for PLM108	NSYDPLM108G	Acc. bag NSYPLM43 to 86	NSYASPLM
Transp. door without locking for PLM32T	NSYDPLM32TG	Locking accessories	References
Glazed door without locking for PLM3025T	NSYDPLM3025TG	Locking and rods for NSYPLM108	NSYVPLM108
Glazed door without locking for PLM43T	NSYDPLM43TG	Double-bar lock for PLM enclosures from 430 (16.93) to 847 (33.35) mm (in.) high	NSYCDBPLM
Glazed door without locking for PLM54T	NSYDPLM54TG		
Glazed door without locking for PLM64T	NSYDPLM64TG		
Glazed door without locking for PLM75T	NSYDPLM75TG		
Glazed door without locking for PLM86T	NSYDPLM86TG		
Glazed door without locking for PLM108T	NSYDPLM108TG		

Applicative solutions: HMI SD



Doors mm (in.)	References	Door accessories	References
Desk lid W 600 (23.62)	NSYDLSDF6	Hinges compact control desk	NSYHSD
Desk lid W 800 (31.50)	NSYDLSDF8	Hinges control desk w/console	NSYHSDF
Desk lid W 1000 (39.37)	NSYDLSDF10	Locking accessories	References
Desk lid W 1200 (47.24)	NSYDLSDF12	Standard handle in RAL 7011	NSYSDFH
Desk lid for w/console W 800 (31.50)	NSYDLSDF8	Lock w/DB 3 (0.12) mm (in.) for frontal doors	NSYFDLSDF
Desk lid for w/console W 1000 (39.37)	NSYDLSDF10	Lock w/DB 3 (0.12) mm (in.) desk lids and covers	NSYDLSDF
Desk lid for w/console W 1200 (47.24)	NSYDLSDF12	Flat escutcheon with DB 5 (0.20) mm (in.)	NSYDFFLOCKDB5
Desk lid for w/console W 1600 (62.99)	NSYDLSDF16		
Folding console cover W 800 (31.50)	NSYCCSDF8		
Folding console cover W 1000 (39.37)	NSYCCSDF10		
Folding console cover W 1200 (47.24)	NSYCCSDF12		
Folding console cover W 1600 (62.99)	NSYCCSDF16		

Applicative solutions: HMI

Door accessories	References
Locking system	NSYLSSDX

Applicative solutions: S3CM

Doors mm (in.)	References	Door accessories	References
Plain door H 200 (7.87) x W 200 (7.87)	NSYDCRN22	Standard Spatial hinge	NSYBICRN
Plain door H 200 (7.87) x W 300 (11.81)	NSYDCRN23	Earthing accessories	References
Plain door H 250 (9.84) x W 200 (7.87)	NSYDCRN2520	Set of 500 earthing labels	NSYSWMEL
Plain door H 300 (11.81) x W 250 (9.84)	NSYDCRN3025		
Plain door H 300 (11.81) x W 300 (11.81)	NSYDCRN33		
Plain door H 300 (11.81) x W 400 (15.75)	NSYDCRN34		
Plain door H 300 (11.81) x W 450 (17.72)	NSYDCRN3045		
Plain door H 400 (15.75) x W 300 (11.81)	NSYDCRN43		
Plain door H 400 (15.75) x W 400 (15.75)	NSYDCRN44		
Plain door H 400 (15.75) x W 600 (23.62)	NSYDCRN46		
Plain door H 500 (19.68) x W 500 (19.68)	NSYDCRN55		
Plain door H 600 (23.62) x W 600 (23.62)	NSYDCRN66		
Plain door H 600 (23.62) x W 800 (31.50)	NSYDCRN68		
Plain door H 800 (31.50) x W 600 (23.62)	NSYDCRN86		

Applicative solutions: EMC, S3HF



Earthing accessories	References
Set of 500 earthing labels	NSYSWMEL
Locking accessories	References
Standard Locking system	NSYAEDLS3HFDB3

Spare Parts Selection Table

Applicative solutions: ATEX S3DEX



NSYDS3D32

Doors mm (in.)	References	Locking accessories mm (in.)	References
Plain door H 300 (11.81) x W 200 (7.87)	NSYDS3D32	Set of 10 linkage guides	NSYS3DLG
Plain door H 300 (11.81) x W 300 (11.81)	NSYDS3D33	Standard key DB3	NSYAEDLS3DKDB3
Plain door H 400 (15.75) x W 300 (11.81)	NSYDS3D43	3 (0.12) point lock linkage H 600 (23.62)	NSYBTAS3D60
Plain door H 400 (15.75) x W 400 (15.75)	NSYDS3D44	3 (0.12) point lock linkage H 700 (27.56)	NSYBTAS3D70
Plain door H 500 (19.68) x W 400 (15.75)	NSYDS3D54	3 (0.12) point lock linkage H 800 (31.50)	NSYBTAS3D80
Plain door H 600 (23.62) x W 400 (15.75)	NSYDS3D64	3 (0.12) point lock linkage H 1000 (39.37)	NSYBTAS3D100
Plain door H 600 (23.62) x W 600 (23.62)	NSYDS3D66	Panels	References
Plain door H 700 (27.56) x W 500 (19.68)	NSYDS3D75	50 caps for holes of hinges WM	NSYSWMCH
Plain door H 800 (31.50) x W 600 (23.62)	NSYDS3D86	Set of 50 back plugs WM	NSYSWMBP
Plain door H 1000 (39.37) x W 800 (31.50)	NSYDS3D108		
Earthing accessories	References		
Set of 500 earthing labels	NSYSWMEL		

Outdoor Heavy-Duty enclosures Thalassa PHD



NSYPPC74HD

Plain doors mm (in.) (door + lock + hinges + door retainer)	Unic door or right door References	Left door References	Aluminum cable gland plate mm (in.)	References
H 538 (21.18) x W 500 (19.68)	NSYDPHD55P	-	For enclosure W 750 (29.53) x D 420 (16.54)	NSYPPC74HD
H 788 (31.02) x W 500 (19.68)	NSYDPHD75P	-	For enclosure W 750 (29.53) x D 620 (24.41)	NSYPPC76HD
H 843 (33.19) x W 750 (29.53)	NSYDPHD77P	-	For enclosure W 500 (19.68) x D 420 (16.54)	NSYPPC54HD
H 1093 (43.03) x W 500 (19.68)	NSYDPHD105P	-	For enclosure W 1250 (49.21) x D 420 (16.54)	NSYPPC54HD + NSYPPC74HD
H 1093 (43.03) x W 750 (29.53)	NSYDPHD107P	-	For enclosure W 1250 (49.21) x D 620 (24.41)	NSYPPC56HD + NSYPPC76HD
H 1343 (52.87) x W 500 (19.68)	NSYDPHD125P	-	Screws and nuts for PHD gland plate (10 units)	NSYPPCPHDSN
H 1343 (52.87) x W 750 (29.53)	NSYDPHD127P	-	Door accessories	References
H 1343 (52.87) x W 1250 (49.21)	NSYDPHD127P	NSYDPHD125LP	Set of 4 complete hinges for PHD	NSYAEDPHD
H 1593 (62.72) x W 750 (29.53)	NSYDPHD157P	-	Locking accessories	References
H 1593 (62.72) x W 1250 (49.21)	NSYDPHD157P	NSYDPHD155LP	Complete lock system for PHD H 500	NSYVPHD5
H 2093 (82.40) x W 750 (29.53)	2 x NSYDPHD107P	-	Complete lock system for PHD H 750	NSYVPHD7
			Complete lock system for PHD H 1000	NSYVPHD10
			Complete lock system for PHD H 1250	NSYVPHD12
			Complete lock system for PHD H 1500	NSYVPHD15
			Complete lock system for PHD H 2000	2 x NSYVPHD10
Ribbed doors mm (in.) (door + lock + hinges + door retainer)	References	References		
H 538 (21.18) x W 500 (19.68)	NSYDPHD55R	-		
H 788 (31.02) x W 500 (19.68)	NSYDPHD75R	-		
H 843 (33.19) x W 750 (29.53)	NSYDPHD77R	-		
H 1093 (43.03) x W 500 (19.68)	NSYDPHD105R	-		
H 1093 (43.03) x W 750 (29.53)	NSYDPHD107R	-		
H 1343 (52.87) x W 500 (19.68)	NSYDPHD125R	-		
H 1343 (52.87) x W 750 (29.53)	NSYDPHD127R	-		
H 1343 (52.87) x W 1250 (49.21)	NSYDPHD127R	NSYDPHD125LR		
H 1593 (62.72) x W 750 (29.53)	NSYDPHD157R	-		
H 1593 (62.72) x W 1250 (49.21)	NSYDPHD157R	NSYDPHD155LR		
H 2093 (82.40) x W 750 (29.53)	2 x NSYDPHD107R	-		

Outdoor Heavy-Duty enclosures Spacial S3HD



NSYTLAUHD

Heavy-Duty cable gland plate for enclosure mm (in.)	References	Hinge	References
H 343 (13.50) x W 200 (7.87) x D 180 (7.09)	NSYTLAUHD	S3HD hinge	NSYAEDH120S3HD
H 448 (17.64) x W 300 (11.81) x D 230 (9.06)	NSYTLCUHD	Canopy mm (in.)	References
H 548 (21.58) x W 400 (15.75) x D 230 (9.06)	NSYTLDUHD	Canopy for S3HD 200 (7.87) (W) x 150 (5.91) (P)	NSYTJ2015HD
H 653 (25.71) x W 400 (15.75) x D 280 (11.02)	NSYTLDUHD	Canopy for S3HD 300 (11.81) (W) x 200 (7.87) (P)	NSYTJ3020HD
H 658 (25.91) x W 600 (23.62) x D 330 (12.99)	NSYTLGUHD	Canopy for S3HD 400 (15.75) (W) x 200 (7.87) (P)	NSYTJ4020HD
H 753 (29.65) x W 500 (19.68) x D 280 (11.02)	NSYTLGUHD	Canopy for S3HD 400 (15.75) (W) x 250 (9.84) (P)	NSYTJ4025HD
H 858 (33.78) x W 600 (23.62) x D 330 (12.99)	NSYTLGUHD	Canopy for S3HD 600 (23.62) (W) x 300 (11.81) (P)	NSYTJ6030HD
H 862 (33.94) x W 800 (31.50) x D 430 (16.93)	2 x NSYTLDUHD	Canopy for S3HD 500 (19.68) (W) x 250 (9.84) (P)	NSYTJ5025HD
H 1062 (41.81) x W 600 (23.62) x D 430 (16.93)	NSYTLGUHD	Canopy for S3HD 800 (31.50) (W) x 400 (15.75) (P)	NSYTJ8040HD
H 1062 (41.81) x W 800 (31.50) x D 430 (16.93)	2 x NSYTLDUHD	Canopy for S3HD 600 (23.62) (W) x 400 (15.75) (P)	NSYTJ6040HD
Door mm (in.)	References	Lock	References
Door 300 (11.81) x 200 (7.87) S3HD, without handle	NSYDS3HD32	Lock S3HD DB 3 (0.12) mm (in.) (Escutcheon+cam+washer)	NSYAEDLS3HDRL
Door 400 (15.75) x 300 (11.81) S3HD, without handle	NSYDS3HD43		
Door 500 (19.68) x 400 (15.75) S3HD, without handle	NSYDS3HD54		
Door 600 (23.62) x 400 (15.75) S3HD + linkage locking syst	NSYDS3HD64		
Door 600 (23.62) x 600 (23.62) S3HD + linkage locking syst	NSYDS3HD66		
Door 700 (27.56) x 500 (19.68) S3HD + linkage locking syst	NSYDS3HD75		
Door 800 (31.50) x 600 (23.62) S3HD + linkage locking syst	NSYDS3HD86		
Door 800 (31.50) x 800 (31.50) S3HD + linkage locking syst	NSYDS3HD88		
Door 1000 (39.37) x 600 (23.62) S3HD + linkage locking syst	NSYDS3HD106		
Door 1000 (39.37) x 800 (31.50) S3HD + linkage locking syst	NSYDS3HD108		





Outdoor Heavy-Duty enclosures Spacial SFHD







NSYSFECA64HD

Heavy-Duty cable gland plate for enclosure mm (in.)	References	Back Panel mm (in.)	References
H 1262 (49.68) x W 600 (23.62) x D 430 (16.93)	NSYSFECA64HD	SFHD 1200 (47.24) x 600 (23.62)	NSYBPHD126
H 1262 (49.68) x W 800 (31.50) x D 430 (16.93)	NSYSFECA64HD	SFHD 1200 (47.24) x 800 (31.50)	NSYBPHD128
H 1262 (49.68) x W 1200 (47.24) x D 430 (16.93)	2 x NSYSFECA64HD	SFHD 1200 (47.24) x 1200 (47.24)	NSYBPHD12122D
H 1281 (50.43) x W 600 (23.62) x D 630 (24.80)	NSYSFECA66HD	SFHD 1600 (62.99) x 600 (23.62)	NSYBPHD166
H 1281 (50.43) x W 800 (31.50) x D 630 (24.80)	NSYSFECA66HD	SFHD 1600 (62.99) x 800 (31.50)	NSYBPHD168
H 1281 (50.43) x W 1200 (47.24) x D 630 (24.80)	2 x NSYSFECA66HD	SFHD 1600 (62.99) x 1200 (47.24)	NSYBPHD1612
H 1662 (65.43) x W 800 (31.50) x D 430 (16.93)	NSYSFECA64HD	SFHD 2000 (78.74) x 800 (31.50)	NSYBPHD208
H 1662 (65.43) x W 1200 (47.24) x D 430 (16.93)	2 x NSYSFECA64HD	Canopy mm (in.)	References
H 1681 (66.18) x W 600 (23.62) x D 630 (24.80)	NSYSFECA66HD	SFHD 600 (23.62) x 400 (15.75)	NSYSC64HD
H 1681 (66.18) x W 800 (31.50) x D 630 (24.80)	NSYSFECA66HD	SFHD 600 (23.62) x 600 (23.62)	NSYSC66HD
H 1681 (66.18) x W 1200 (47.24) x D 630 (24.80)	2 x NSYSFECA66HD	SFHD 800 (31.50) x 400 (15.75)	NSYSC84HD
H 2062 (81.18) x W 800 (31.50) x D 430 (16.93)	NSYSFECA64HD	SFHD 800 (31.50) x 600 (23.62)	NSYSC86HD
Door mm (in.)	References	SFHD 1200 (47.24) x 400 (15.75)	NSYSC124HD
Plain door SFHD 1200 (47.24) x 600 (23.62)	NSYSFDHD126	SFHD 1200 (47.24) x 600 (23.62)	NSYSC126HD
Plain door SFHD 1200 (47.24) x 800 (31.50)	NSYSFDHD128	Handle with 1242E cylindrical barrel	References
Plain door SFHD 1200 (47.24) x 1200 (47.24)	NSYSFDHD12122D	Handle SFHD 1242E	NSYSFHS1HD
Plain door SFHD 1600 (62.99) x 600 (23.62)	NSYSFDHD166	Captive screws	References
Plain door SFHD 1600 (62.99) x 800 (31.50)	NSYSFDHD168	Captive screws for Spacial SFHD panels	NSYCSSFHD
Plain door doble SFHD 1600 (62.99) x 1200 (47.24)	NSYSFDHD16122D		
Plain door SFHD 2000 (78.74) x 800 (31.50)	NSYSFDHD208		

Air-to-air exchangers

				
Exchanger Battery	Fan (Fan + Capacitor)	Frontal Cover RAL 7035 grey	Thermostat	Mounting Kit (instruction + full seal + screws)
References	References	References	References	References
NSYCEA14E	NSYCUSP0030	NSYCUSP0042	NSYCUSP0076	-
NSYCEA22E	NSYCUSP0177	NSYCUSP0042	NSYCUSP0181	-
NSYCEA36	NSYCUSP0031	NSYCUSP0044	NSYCUSP0077	NSYCUSP0100
NSYCEA50	NSYCUSP0032	NSYCUSP0044	NSYCUSP0077	NSYCUSP0100
NSYCEA80	NSYCUSP0033	NSYCUSP0138	NSYCUSP0078	NSYCUSP0100
				NSYCUSP0111
				NSYCUSP0184
				NSYCUSP0112
				NSYCUSP0112
				NSYCUSP0113

Air-to-water exchangers

			
Exchanger Battery	Fan (Fan + Capacitor)	Frontal Cover RAL 7035 grey	Frontal Cover Stainless-Steel
References	References	References	References
NSYCEW1K	NSYCUSP0034	NSYCUSP0043	NSYCUSP0079
NSYCEWX1K	NSYCUSP0034	NSYCUSP0043	-
NSYCEW1K8	NSYCUSP0035	NSYCUSP0044	NSYCUSP0080
NSYCEWX1K8	NSYCUSP0035	NSYCUSP0044	-
NSYCEW2K5	NSYCUSP0036	NSYCUSP0136	NSYCUSP0080
NSYCEWX2K5	NSYCUSP0036	NSYCUSP0136	-
NSYCEW3K5	NSYCUSP0037	NSYCUSP0138	NSYCUSP0081
NSYCEW4K5	NSYCUSP0037	NSYCUSP0137	NSYCUSP0081
NSYCEW6K	NSYCUSP0038	NSYCUSP0137	NSYCUSP0082
NSYCEW6K2P4	NSYCUSP0038	NSYCUSP0137	NSYCUSP0082
NSYCEW2K5R	NSYCUSP0041	NSYCUSP0053	NSYCUSP0084
			-
			NSYCUSP0094
			-
			NSYCUSP0095
			-
			NSYCUSP0095
			-
			-
			-
			-

Air-to-water exchangers



Thermostat

Transformer

Solenoid Valve

Mounting Kit
(instruction + full seal + screws)

References	References	References	References	References
NSYCEW1K	NSYCUSP0100	-	NSYCUSP0108	NSYCUSP0114
NSYCEWX1K	NSYCUSP0100	-	NSYCUSP0108	NSYCUSP0114
NSYCEW1K8	NSYCUSP0100	-	NSYCUSP0109	NSYCUSP0124
NSYCEWX1K8	NSYCUSP0100	-	NSYCUSP0109	NSYCUSP0124
NSYCEW2K5	NSYCUSP0100	-	NSYCUSP0109	NSYCUSP0124
NSYCEWX2K5	NSYCUSP0100	-	NSYCUSP0109	NSYCUSP0124
NSYCEW3K5	NSYCUSP0100	-	NSYCUSP0109	NSYCUSP0115
NSYCEW4K5	NSYCUSP0100	-	NSYCUSP0109	NSYCUSP0115
NSYCEW6K	NSYCUSP0100	-	NSYCUSP0109	NSYCUSP0125
NSYCEW6K2P4	NSYCUSP0100	NSYCUSP0107	NSYCUSP0109	NSYCUSP0125
NSYCEW2K5R	NSYCUSP0100	-	NSYCUSP0109	NSYCUSP0117

Cooling units: Side-mounted models

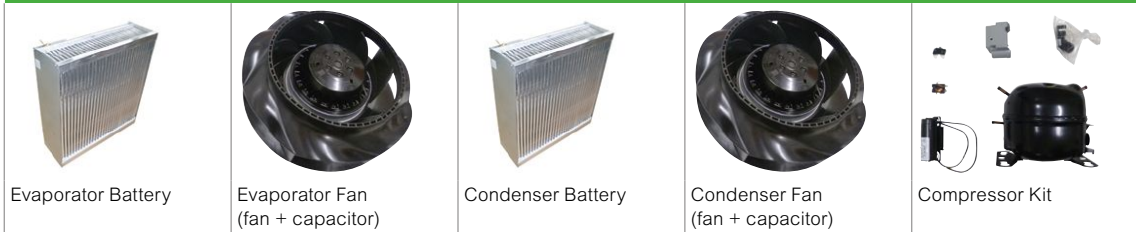

References	References	References	References	References	References
NSYCU300H	NSYCUSP0001	NSYCUSP0042	NSYCUSP0013	NSYCUSP0042	NSYCUSP0054
NSYCU400	NSYCUSP0002	NSYCUSP0042	NSYCUSP0014	NSYCUSP0042	NSYCUSP0055
NSYCU400UL	NSYCUSP0002	NSYCUSP0042	NSYCUSP0014	NSYCUSP0042	NSYCUSP0055
NSYCUX400	NSYCUSP0002	NSYCUSP0042	NSYCUSP0014	NSYCUSP0042	NSYCUSP0055
NSYCU600	NSYCUSP0003	NSYCUSP0043	NSYCUSP0015	NSYCUSP0044	NSYCUSP0056
NSYCUX600	NSYCUSP0003	NSYCUSP0043	NSYCUSP0015	NSYCUSP0044	NSYCUSP0056
NSYCU600UL	NSYCUSP0003	NSYCUSP0043	NSYCUSP0015	NSYCUSP0044	NSYCUSP0056
NSYCUX600UL	NSYCUSP0003	NSYCUSP0043	NSYCUSP0015	NSYCUSP0044	NSYCUSP0056
NSYCU800	NSYCUSP0004	NSYCUSP0043	NSYCUSP0016	NSYCUSP0044	NSYCUSP0057
NSYCUX800	NSYCUSP0004	NSYCUSP0043	NSYCUSP0016	NSYCUSP0044	NSYCUSP0057
NSYCU800UL	NSYCUSP0004	NSYCUSP0043	NSYCUSP0016	NSYCUSP0044	NSYCUSP0057
NSYCUX800UL	NSYCUSP0004	NSYCUSP0043	NSYCUSP0016	NSYCUSP0044	NSYCUSP0057
NSYCU1K	NSYCUSP0004	NSYCUSP0043	NSYCUSP0017	NSYCUSP0044	NSYCUSP0057
NSYCUX1K	NSYCUSP0004	NSYCUSP0043	NSYCUSP0017	NSYCUSP0044	NSYCUSP0057
NSYCU1KUL	NSYCUSP0004	NSYCUSP0043	NSYCUSP0017	NSYCUSP0044	NSYCUSP0057
NSYCUX1KUL	NSYCUSP0004	NSYCUSP0043	NSYCUSP0017	NSYCUSP0044	NSYCUSP0057
NSYCU1K2P4	NSYCUSP0004	NSYCUSP0043	NSYCUSP0017	NSYCUSP0044	NSYCUSP0057
NSYCUX1K2P4	NSYCUSP0004	NSYCUSP0043	NSYCUSP0017	NSYCUSP0044	NSYCUSP0057
NSYCU1K2P4UL	NSYCUSP0004	NSYCUSP0043	NSYCUSP0017	NSYCUSP0044	NSYCUSP0057
NSYCUX1K2P4UL	NSYCUSP0004	NSYCUSP0043	NSYCUSP0017	NSYCUSP0044	NSYCUSP0057
NSYCU1K2	NSYCUSP0005	NSYCUSP0044	NSYCUSP0018	NSYCUSP0136	NSYCUSP0058
NSYCUX1K2	NSYCUSP0005	NSYCUSP0044	NSYCUSP0018	NSYCUSP0136	NSYCUSP0058
NSYCU1K2UL	NSYCUSP0005	NSYCUSP0044	NSYCUSP0018	NSYCUSP0136	NSYCUSP0058
NSYCUX1K2UL	NSYCUSP0005	NSYCUSP0044	NSYCUSP0018	NSYCUSP0136	NSYCUSP0058
NSYCU1K22P4	NSYCUSP0005	NSYCUSP0044	NSYCUSP0018	NSYCUSP0136	NSYCUSP0058
NSYCUX1K22P4	NSYCUSP0005	NSYCUSP0044	NSYCUSP0018	NSYCUSP0136	NSYCUSP0058
NSYCU1K6	NSYCUSP0006	NSYCUSP0044	NSYCUSP0019	NSYCUSP0138	NSYCUSP0059
NSYCUX1K6	NSYCUSP0006	NSYCUSP0044	NSYCUSP0019	NSYCUSP0138	NSYCUSP0059
NSYCU1K6UL	NSYCUSP0006	NSYCUSP0044	NSYCUSP0019	NSYCUSP0138	NSYCUSP0059
NSYCUX1K6UL	NSYCUSP0006	NSYCUSP0044	NSYCUSP0019	NSYCUSP0138	NSYCUSP0059
NSYCU1K62P4	NSYCUSP0006	NSYCUSP0044	NSYCUSP0019	NSYCUSP0138	NSYCUSP0059
NSYCUX1K62P4	NSYCUSP0006	NSYCUSP0044	NSYCUSP0019	NSYCUSP0138	NSYCUSP0059
NSYCU1K62P4UL	NSYCUSP0006	NSYCUSP0044	NSYCUSP0019	NSYCUSP0138	NSYCUSP0059
NSYCUX1K62P4UL	NSYCUSP0006	NSYCUSP0044	NSYCUSP0019	NSYCUSP0138	NSYCUSP0059

Cooling units: Side-mounted models

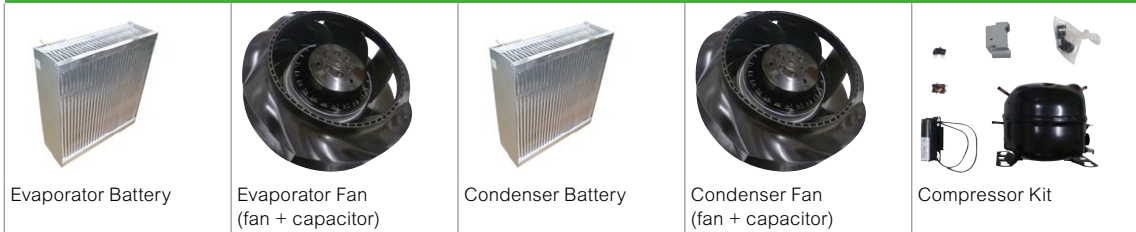

References	References	References	References	References	References
NSYCU2K	NSYCUSP0006	NSYCUSP0136	NSYCUSP0020	NSYCUSP0138	NSYCUSP0060
NSYCUX2K	NSYCUSP0006	NSYCUSP0136	NSYCUSP0020	NSYCUSP0138	NSYCUSP0060
NSYCU2KUL	NSYCUSP0006	NSYCUSP0136	NSYCUSP0020	NSYCUSP0138	NSYCUSP0139
NSYCUX2KUL	NSYCUSP0006	NSYCUSP0136	NSYCUSP0020	NSYCUSP0138	NSYCUSP0139
NSYCU2K3P4	NSYCUSP0006	NSYCUSP0136	NSYCUSP0020	NSYCUSP0138	NSYCUSP0061
NSYCUX2K3P4	NSYCUSP0006	NSYCUSP0136	NSYCUSP0020	NSYCUSP0138	NSYCUSP0061
NSYCU2K3P4UL	NSYCUSP0006	NSYCUSP0136	NSYCUSP0020	NSYCUSP0138	NSYCUSP0062
NSYCUX2K3P4UL	NSYCUSP0006	NSYCUSP0136	NSYCUSP0020	NSYCUSP0138	NSYCUSP0062
NSYCU3K3P4	NSYCUSP0007	NSYCUSP0137	NSYCUSP0021	NSYCUSP0137	NSYCUSP0062
NSYCUX3K3P4	NSYCUSP0007	NSYCUSP0137	NSYCUSP0021	NSYCUSP0137	NSYCUSP0062
NSYCU3K3P4UL	NSYCUSP0007	NSYCUSP0137	NSYCUSP0021	NSYCUSP0137	NSYCUSP0062
NSYCUX3K3P4UL	NSYCUSP0007	NSYCUSP0137	NSYCUSP0021	NSYCUSP0137	NSYCUSP0062
NSYCU4K3P4	NSYCUSP0007	NSYCUSP0137	NSYCUSP0022	NSYCUSP0137	NSYCUSP0063
NSYCUX4K3P4	NSYCUSP0007	NSYCUSP0137	NSYCUSP0022	NSYCUSP0137	NSYCUSP0063
NSYCU4K3P4UL	NSYCUSP0007	NSYCUSP0137	NSYCUSP0022	NSYCUSP0137	NSYCUSP0063
NSYCUX4K3P4UL	NSYCUSP0007	NSYCUSP0137	NSYCUSP0022	NSYCUSP0137	NSYCUSP0063
NSYCU6K3P4	-	-	-	-	-

Cooling units and side-mounted models







References	References	References	References	References	References
NSYCU300H	NSYCUSP0066	-	NSYCUSP0099	-	NSYCUSP0118
NSYCU400	NSYCUSP0067	-	NSYCUSP0099	-	NSYCUSP0126
NSYCU400UL	NSYCUSP0067	-	NSYCUSP0144	-	NSYCUSP0126
NSYCUX400	-	NSYCUSP0085	NSYCUSP0099	-	NSYCUSP0126
NSYCU600	NSYCUSP0068	-	NSYCUSP0099	-	NSYCUSP0127
NSYCU600	-	NSYCUSP0086	NSYCUSP0099	-	NSYCUSP0127
NSYCU600UL	NSYCUSP0068	-	NSYCUSP0144	-	NSYCUSP0127
NSYCUX600UL	-	NSYCUSP0086	NSYCUSP0144	-	NSYCUSP0127
NSYCU800	NSYCUSP0069	-	NSYCUSP0099	-	NSYCUSP0119
NSYCUX800	-	NSYCUSP0087	NSYCUSP0099	-	NSYCUSP0119
NSYCU800UL	NSYCUSP0069	-	NSYCUSP0144	-	NSYCUSP0119
NSYCUX800UL	-	NSYCUSP0087	NSYCUSP0144	-	NSYCUSP0119
NSYCU1K	NSYCUSP0069	-	NSYCUSP0099	-	NSYCUSP0119
NSYCUX1K	-	NSYCUSP0087	NSYCUSP0099	-	NSYCUSP0119
NSYCU1KUL	NSYCUSP0069	-	NSYCUSP0144	-	NSYCUSP0119
NSYCUX1KUL	-	NSYCUSP0087	NSYCUSP0144	-	NSYCUSP0119
NSYCU1K2P4	NSYCUSP0069	-	NSYCUSP0099	NSYCUSP0101	NSYCUSP0119
NSYCUX1K2P4	-	NSYCUSP0087	NSYCUSP0099	NSYCUSP0101	NSYCUSP0119
NSYCU1K2P4UL	NSYCUSP0069	-	NSYCUSP0144	NSYCUSP0173	NSYCUSP0119
NSYCUX1K2P4UL	-	NSYCUSP0087	NSYCUSP0144	NSYCUSP0173	NSYCUSP0119
NSYCU1K2	NSYCUSP0070	-	NSYCUSP0099	-	NSYCUSP0120
NSYCUX1K2	-	NSYCUSP0088	NSYCUSP0099	-	NSYCUSP0120
NSYCU1K2UL	NSYCUSP0070	-	NSYCUSP0144	-	NSYCUSP0120
NSYCUX1K2UL	-	NSYCUSP0088	NSYCUSP0144	-	NSYCUSP0120
NSYCU1K22P4	NSYCUSP0070	-	NSYCUSP0099	NSYCUSP0102	NSYCUSP0120
NSYCUX1K22P4	-	NSYCUSP0088	NSYCUSP0099	NSYCUSP0102	NSYCUSP0120
NSYCU1K6	NSYCUSP0070	-	NSYCUSP0099	-	NSYCUSP0120
NSYCUX1K6	-	NSYCUSP0088	NSYCUSP0099	-	NSYCUSP0120
NSYCU1K6UL	NSYCUSP0070	-	NSYCUSP0144	-	NSYCUSP0120
NSYCUX1K6UL	-	NSYCUSP0088	NSYCUSP0144	-	NSYCUSP0120
NSYCU1K62P4	NSYCUSP0070	-	NSYCUSP0099	NSYCUSP0103	NSYCUSP0120
NSYCUX1K62P4	-	NSYCUSP0088	NSYCUSP0099	NSYCUSP0103	NSYCUSP0120
NSYCU1K62P4UL	NSYCUSP0070	-	NSYCUSP0144	NSYCUSP0174	NSYCUSP0120
NSYCUX1K62P4UL	-	NSYCUSP0088	NSYCUSP0144	NSYCUSP0174	NSYCUSP0120

Cooling units and side-mounted models



References	References	References	References	References	References
NSYCU2K	NSYCUSP0070	-	NSYCUSP0099	-	NSYCUSP0120
NSYCUX2K	-	NSYCUSP0088	NSYCUSP0099	-	NSYCUSP0120
NSYCU2KUL	NSYCUSP0070	-	NSYCUSP0144	-	NSYCUSP0120
NSYCUX2KUL	-	NSYCUSP0088	NSYCUSP0144	-	NSYCUSP0120
NSYCU2K3P4	NSYCUSP0070	-	NSYCUSP0099	NSYCUSP0104	NSYCUSP0120
NSYCUX2K3P4	-	NSYCUSP0088	NSYCUSP0099	NSYCUSP0104	NSYCUSP0120
NSYCU2K3P4UL	NSYCUSP0070	-	NSYCUSP0144	NSYCUSP0147	NSYCUSP0120
NSYCUX2K3P4UL	-	NSYCUSP0088	NSYCUSP0144	NSYCUSP0147	NSYCUSP0120
NSYCU3K3P4	NSYCUSP0071	-	NSYCUSP0099	NSYCUSP0105	NSYCUSP0128
NSYCUX3K3P4	-	NSYCUSP0089	NSYCUSP0099	NSYCUSP0105	NSYCUSP0128
NSYCU3K3P4UL	NSYCUSP0071	-	NSYCUSP0144	NSYCUSP0148	NSYCUSP0128
NSYCUX3K3P4UL	-	NSYCUSP0089	NSYCUSP0144	NSYCUSP0148	NSYCUSP0128
NSYCU4K3P4	NSYCUSP0071	-	NSYCUSP0099	NSYCUSP0105	NSYCUSP0128
NSYCUX4K3P4	-	NSYCUSP0089	NSYCUSP0099	NSYCUSP0105	NSYCUSP0128
NSYCU4K3P4UL	NSYCUSP0071	-	NSYCUSP0144	NSYCUSP0148	NSYCUSP0128
NSYCUX4K3P4UL	-	NSYCUSP0089	NSYCUSP0144	NSYCUSP0148	NSYCUSP0128
NSYCU6K3P4	-	-	NSYCUSP0099	-	-



Cooling units: Roof mount					
References	References	References	References	References	References
					
Evaporator battery	Evaporator fan (fan + capacitor)	Condenser battery	Condenser fan (fan + capacitor)	Compressor kit	
References	References	References	References	References	References
NSYCU400R	NSYCUSP0008	NSYCUSP0047	NSYCUSP0023	NSYCUSP0043	NSYCUSP0064
NSYCUX400R	NSYCUSP0008	NSYCUSP0047	NSYCUSP0023	NSYCUSP0043	NSYCUSP0064
NSYCU400RUL	NSYCUSP0008	NSYCUSP0047	NSYCUSP0023	NSYCUSP0043	NSYCUSP0172
NSYCU800R	NSYCUSP0009	NSYCUSP0044	NSYCUSP0024	NSYCUSP0136	NSYCUSP0065
NSYCUX800R	NSYCUSP0009	NSYCUSP0044	NSYCUSP0024	NSYCUSP0136	NSYCUSP0065
NSYCU800RUL	NSYCUSP0009	NSYCUSP0044	NSYCUSP0024	NSYCUSP0136	NSYCUSP0065
NSYCU1K2R	NSYCUSP0010	NSYCUSP0044	NSYCUSP0025	NSYCUSP0049	NSYCUSP0065
NSYCUX1K2R	NSYCUSP0010	NSYCUSP0044	NSYCUSP0025	NSYCUSP0049	NSYCUSP0065
NSYCU1K2RUL	NSYCUSP0010	NSYCUSP0044	NSYCUSP0025	NSYCUSP0049	NSYCUSP0065
NSYCU1K5R	NSYCUSP0010	NSYCUSP0136	NSYCUSP0026	NSYCUSP0049	NSYCUSP0059
NSYCUX1K5R	NSYCUSP0010	NSYCUSP0136	NSYCUSP0026	NSYCUSP0049	NSYCUSP0059
NSYCU1K5RUL	NSYCUSP0010	NSYCUSP0136	NSYCUSP0026	NSYCUSP0049	NSYCUSP0059
NSYCU2K3P4R	NSYCUSP0011	NSYCUSP0136	NSYCUSP0027	NSYCUSP0049	NSYCUSP0061
NSYCUX2K3P4R	NSYCUSP0011	NSYCUSP0136	NSYCUSP0027	NSYCUSP0049	NSYCUSP0061
NSYCU2K3P4RUL	NSYCUSP0011	NSYCUSP0136	NSYCUSP0027	NSYCUSP0049	NSYCUSP0062
NSYCU2KR	NSYCUSP0011	NSYCUSP0136	NSYCUSP0027	NSYCUSP0049	NSYCUSP0060
NSYCUX2KR	NSYCUSP0011	NSYCUSP0136	NSYCUSP0027	NSYCUSP0049	NSYCUSP0060
NSYCU3K3P4R	NSYCUSP0012	NSYCUSP0136	NSYCUSP0028	NSYCUSP0051	NSYCUSP0062
NSYCUX3K3P4R	NSYCUSP0012	NSYCUSP0136	NSYCUSP0028	NSYCUSP0051	NSYCUSP0062
NSYCU3K3P4RUL	NSYCUSP0012	NSYCUSP0136	NSYCUSP0028	NSYCUSP0051	NSYCUSP0062
NSYCU4K3P4R	NSYCUSP0012	NSYCUSP0137	NSYCUSP0029	NSYCUSP0051	NSYCUSP0063
NSYCUX4K3P4R	NSYCUSP0012	NSYCUSP0137	NSYCUSP0029	NSYCUSP0051	NSYCUSP0063
NSYCU4K3P4RUL	NSYCUSP0012	NSYCUSP0137	NSYCUSP0029	NSYCUSP0051	NSYCUSP0063

Cooling units: Roof mount



References	References	References	References	References	References
NSYCU400R	NSYCUSP0072	-	NSYCUSP0099	-	NSYCUSP0121
NSYCUX400R	-	NSYCUSP0090	NSYCUSP0099	-	NSYCUSP0121
NSYCU400RUL	NSYCUSP0072	-	NSYCUSP0144	-	NSYCUSP0121
NSYCU800R	NSYCUSP0073	-	NSYCUSP0099	-	NSYCUSP0122
NSYCUX800R	-	NSYCUSP0091	NSYCUSP0099	-	NSYCUSP0122
NSYCU800RUL	NSYCUSP0073	-	NSYCUSP0144	-	NSYCUSP0122
NSYCU1K2R	NSYCUSP0074	-	NSYCUSP0099	-	NSYCUSP0129
NSYCUX1K2R	-	NSYCUSP0092	NSYCUSP0099	-	NSYCUSP0129
NSYCU1K2RUL	NSYCUSP0074	-	NSYCUSP0144	-	NSYCUSP0129
NSYCU1K5R	NSYCUSP0074	-	NSYCUSP0099	-	NSYCUSP0129
NSYCUX1K5R	-	NSYCUSP0092	NSYCUSP0099	-	NSYCUSP0129
NSYCU1K5RUL	NSYCUSP0074	-	NSYCUSP0144	-	NSYCUSP0129
NSYCU2K3P4R	NSYCUSP0074	-	NSYCUSP0099	NSYCUSP0104	NSYCUSP0129
NSYCUX2K3P4R	-	NSYCUSP0092	NSYCUSP0099	NSYCUSP0104	NSYCUSP0129
NSYCU2K3P4RUL	NSYCUSP0074	-	NSYCUSP0144	NSYCUSP0147	NSYCUSP0129
NSYCU2KR	NSYCUSP0074	-	NSYCUSP0099	-	NSYCUSP0129
NSYCUX2KR	-	NSYCUSP0092	NSYCUSP0099	-	NSYCUSP0129
NSYCU3K3P4R	NSYCUSP0075	-	NSYCUSP0099	NSYCUSP0106	NSYCUSP0123
NSYCUX3K3P4R	-	NSYCUSP0093	NSYCUSP0099	NSYCUSP0106	NSYCUSP0123
NSYCU3K3P4RUL	NSYCUSP0075	-	NSYCUSP0144	NSYCUSP0148	NSYCUSP0123
NSYCU4K3P4R	NSYCUSP0075	-	NSYCUSP0099	NSYCUSP0105	NSYCUSP0123
NSYCUX4K3P4R	-	NSYCUSP0093	NSYCUSP0099	NSYCUSP0105	NSYCUSP0123
NSYCU4K3P4RUL	NSYCUSP0075	-	NSYCUSP0144	NSYCUSP0148	NSYCUSP0123

Cooling units: Heavy-Duty					
					
Evaporator battery	Evaporator fan (fan + capacitor)	Condenser battery	Condenser fan (fan + capacitor)	Compressor kit	
References	References	References	References	References	References
NSYCUHD400	NSYCUSP0002	NSYCUSP0042	NSYCUSP0158	NSYCUSP0042	NSYCUSP0055
NSYCUHD600	NSYCUSP0003	NSYCUSP0043	NSYCUSP0159	NSYCUSP0044	NSYCUSP0056
NSYCUHD800	NSYCUSP0004	NSYCUSP0043	NSYCUSP0160	NSYCUSP0044	NSYCUSP0057
NSYCUHD1K	NSYCUSP0004	NSYCUSP0043	NSYCUSP0161	NSYCUSP0044	NSYCUSP0057
NSYCUHD1K2P4	NSYCUSP0004	NSYCUSP0043	NSYCUSP0161	NSYCUSP0044	NSYCUSP0057
NSYCUHD1K6	NSYCUSP0006	NSYCUSP0044	NSYCUSP0162	NSYCUSP0138	NSYCUSP0059
NSYCUHD1K62P4	NSYCUSP0006	NSYCUSP0044	NSYCUSP0162	NSYCUSP0138	NSYCUSP0059
NSYCUHD2K3P4	NSYCUSP0006	NSYCUSP0136	NSYCUSP0163	NSYCUSP0138	NSYCUSP0061
NSYCUHD3K3P4	NSYCUSP0007	NSYCUSP0137	NSYCUSP0164	NSYCUSP0137	NSYCUSP0062
NSYCUHD4K3P4	NSYCUSP0007	NSYCUSP0137	NSYCUSP0165	NSYCUSP0137	NSYCUSP0063

Cooling units: Heavy-Duty				
				
Frontal cover RAL 7035 grey	Thermostat		Transformer	Mounting Kit (instruction + full seal + screws)
References	References	References	References	References
NSYCUHD400	NSYCUSP0167	NSYCUSP0100	-	NSYCUSP0153
NSYCUHD600	NSYCUSP0168	NSYCUSP0100	-	NSYCUSP0154
NSYCUHD800	NSYCUSP0169	NSYCUSP0100	-	NSYCUSP0155
NSYCUHD1K	NSYCUSP0169	NSYCUSP0100	-	NSYCUSP0155
NSYCUHD1K2P4	NSYCUSP0169	NSYCUSP0100	NSYCUSP0101	NSYCUSP0155
NSYCUHD1K6	NSYCUSP0170	NSYCUSP0100	-	NSYCUSP0156
NSYCUHD1K62P4	NSYCUSP0170	NSYCUSP0100	NSYCUSP0103	NSYCUSP0156
NSYCUHD2K3P4	NSYCUSP0170	NSYCUSP0100	NSYCUSP0104	NSYCUSP0156
NSYCUHD3K3P4	NSYCUSP0171	NSYCUSP0100	NSYCUSP0105	NSYCUSP0157
NSYCUHD4K3P4	NSYCUSP0171	NSYCUSP0100	NSYCUSP0105	NSYCUSP0157

Cooling units: Slim

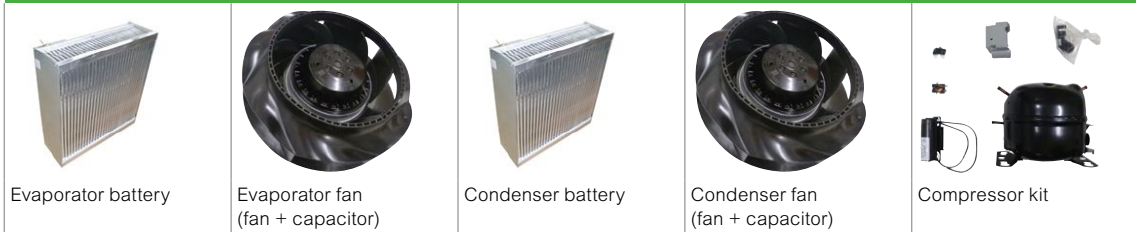

References	References	References	References	References	References
NSYCUS1K1UL	NSYCUSP0130	NSYCUSP0136	NSYCUSP0133	NSYCUSP0136	NSYCUSP0059
NSYCUSX1K1UL	NSYCUSP0130	NSYCUSP0136	NSYCUSP0133	NSYCUSP0136	NSYCUSP0059
NSYCUS1K12P4UL	NSYCUSP0130	NSYCUSP0136	NSYCUSP0133	NSYCUSP0136	NSYCUSP0059
NSYCUSX1K12P4UL	NSYCUSP0130	NSYCUSP0136	NSYCUSP0133	NSYCUSP0136	NSYCUSP0059
NSYCUS1K5UL	NSYCUSP0131	NSYCUSP0136	NSYCUSP0133	NSYCUSP0138	NSYCUSP0059
NSYCUSX1K5UL	NSYCUSP0131	NSYCUSP0136	NSYCUSP0133	NSYCUSP0138	NSYCUSP0059
NSYCUS1K52P4UL	NSYCUSP0131	NSYCUSP0136	NSYCUSP0133	NSYCUSP0138	NSYCUSP0059
NSYCUSX1K52P4UL	NSYCUSP0131	NSYCUSP0136	NSYCUSP0133	NSYCUSP0138	NSYCUSP0059
NSYCUS2KUL	NSYCUSP0131	NSYCUSP0136	NSYCUSP0134	NSYCUSP0138	NSYCUSP0139
NSYCUSX2KUL	NSYCUSP0131	NSYCUSP0136	NSYCUSP0134	NSYCUSP0138	NSYCUSP0139
NSYCUS2K3P4UL	NSYCUSP0131	NSYCUSP0136	NSYCUSP0134	NSYCUSP0138	NSYCUSP0062
NSYCUSX2K3P4UL	NSYCUSP0131	NSYCUSP0136	NSYCUSP0134	NSYCUSP0138	NSYCUSP0062
NSYCUS2K5UL	NSYCUSP0132	NSYCUSP0137	NSYCUSP0135	NSYCUSP0137	NSYCUSP0140
NSYCUSX2K5UL	NSYCUSP0132	NSYCUSP0137	NSYCUSP0135	NSYCUSP0137	NSYCUSP0140
NSYCUS2K53P4UL	NSYCUSP0132	NSYCUSP0137	NSYCUSP0135	NSYCUSP0137	NSYCUSP0062
NSYCUSX2K53P4UL	NSYCUSP0132	NSYCUSP0137	NSYCUSP0135	NSYCUSP0137	NSYCUSP0062
NSYCUS3K2UL	NSYCUSP0132	NSYCUSP0137	NSYCUSP0135	NSYCUSP0137	NSYCUSP0141
NSYCUSX3K2UL	NSYCUSP0132	NSYCUSP0137	NSYCUSP0135	NSYCUSP0137	NSYCUSP0141
NSYCUS3K23P4UL	NSYCUSP0132	NSYCUSP0137	NSYCUSP0135	NSYCUSP0137	NSYCUSP0063
NSYCUSX3K23P4UL	NSYCUSP0132	NSYCUSP0137	NSYCUSP0135	NSYCUSP0137	NSYCUSP0063

Cooling units: Slim

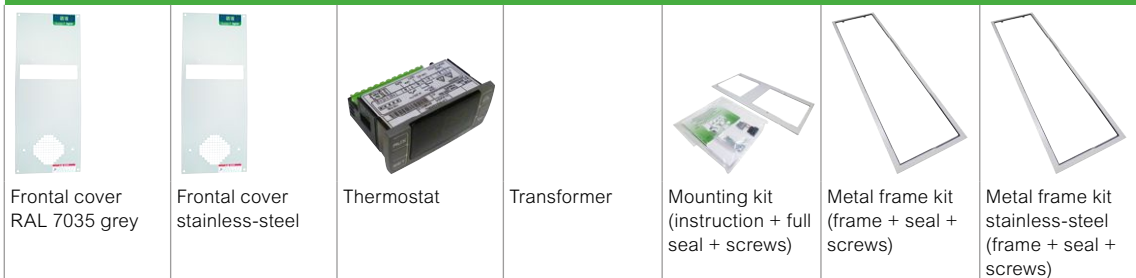

References	References	References	References	References	References	References	References
NSYCUS1K1UL	NSYCUSP0142	-	NSYCUSP0144	-	NSYCUSP0149	NSYCUSP0152	NSYCUSP0166
NSYCUSX1K1UL	-	NSYCUSP0150	NSYCUSP0144	-	NSYCUSP0149	NSYCUSP0152	NSYCUSP0166
NSYCUS1K12P4UL	NSYCUSP0142	-	NSYCUSP0144	NSYCUSP0145	NSYCUSP0149	NSYCUSP0152	NSYCUSP0166
NSYCUSX1K12P4UL	-	NSYCUSP0150	NSYCUSP0144	NSYCUSP0145	NSYCUSP0149	NSYCUSP0152	NSYCUSP0166
NSYCUS1K5UL	NSYCUSP0142	-	NSYCUSP0144	-	NSYCUSP0149	NSYCUSP0152	NSYCUSP0166
NSYCUSX1K5UL	-	NSYCUSP0150	NSYCUSP0144	-	NSYCUSP0149	NSYCUSP0152	NSYCUSP0166
NSYCUS1K52P4UL	NSYCUSP0142	-	NSYCUSP0144	NSYCUSP0146	NSYCUSP0149	NSYCUSP0152	NSYCUSP0166
NSYCUSX1K52P4UL	-	NSYCUSP0150	NSYCUSP0144	NSYCUSP0146	NSYCUSP0149	NSYCUSP0152	NSYCUSP0166
NSYCUS2KUL	NSYCUSP0142	-	NSYCUSP0144	-	NSYCUSP0149	NSYCUSP0152	NSYCUSP0166
NSYCUSX2KUL	-	NSYCUSP0150	NSYCUSP0144	-	NSYCUSP0149	NSYCUSP0152	NSYCUSP0166
NSYCUS2K3P4UL	NSYCUSP0142	-	NSYCUSP0144	NSYCUSP0147	NSYCUSP0149	NSYCUSP0152	NSYCUSP0166
NSYCUSX2K3P4UL	-	NSYCUSP0150	NSYCUSP0144	NSYCUSP0147	NSYCUSP0149	NSYCUSP0152	NSYCUSP0166
NSYCUS2K5UL	NSYCUSP0143	-	NSYCUSP0144	-	NSYCUSP0149	NSYCUSP0152	NSYCUSP0166
NSYCUSX2K5UL	-	NSYCUSP0151	NSYCUSP0144	-	NSYCUSP0149	NSYCUSP0152	NSYCUSP0166
NSYCUS2K53P4UL	NSYCUSP0143	-	NSYCUSP0144	NSYCUSP0148	NSYCUSP0149	NSYCUSP0152	NSYCUSP0166
NSYCUSX2K53P4UL	-	NSYCUSP0151	NSYCUSP0144	NSYCUSP0148	NSYCUSP0149	NSYCUSP0152	NSYCUSP0166
NSYCUS3K2UL	NSYCUSP0143	-	NSYCUSP0144	-	NSYCUSP0149	NSYCUSP0152	NSYCUSP0166
NSYCUSX3K2UL	-	NSYCUSP0151	NSYCUSP0144	-	NSYCUSP0149	NSYCUSP0152	NSYCUSP0166
NSYCUS3K23P4UL	NSYCUSP0143	-	NSYCUSP0144	NSYCUSP0148	NSYCUSP0149	NSYCUSP0152	NSYCUSP0166
NSYCUSX3K23P4UL	-	NSYCUSP0151	NSYCUSP0144	NSYCUSP0148	NSYCUSP0149	NSYCUSP0152	NSYCUSP0166

Index of references

1	Page
13934	171, 174
A	Page
AF1CF34	265, 271
AF1CF56	265, 271
AF1CG4	271
AF1CG5	271
AF1CG6	271
AF1EA3	242, 270
AF1EA4	242, 270
AF1EA5	242, 270
AF1EA6	242, 270
AF1GC4	265
AF1GC5	265
AF1GC6	265
AF1VA410	270
AF1VA416	270
AF1VA512	270
AF1VA518	270
AF1VA612	251, 270
AF1VA618	251, 270
AF1VC820	251, 270
AK2CA3	292
AK2CA6	292
AK2CD100	292
AK2CD125	292
AK2CD25	292
AK2CD37	292
AK2CD50	292
AK2CD75	292
AK2GA315	292
AK2GA33	292
AK2GA35	292
AK2GA39	292
AK2GA615	292
AK2GA65	292
AK2GA69	292
AK2GD10075	292
AK2GD12575	292
AK2GD2525	292
AK2GD2550	292
AK2GD3750	292
AK2GD3775	292
AK2GD5050	292
AK2GD5075	292
AK2GD7550	292
AK2GD7575	292
AK2LA39	291
AK2LD01	291
AK2LD02	291
AM1DL201	264
AM1EA200	264
AM1EC200	263
AM1PA0670	241
AM1PA1270	241
AM1PA3015	241
AM1PA3020	241
AM1PA3050	241
AM1PA3070	241

A	Page
AM1PA4030	241
AM1PA6040	241
AM1PA6050	241
AM1PA6060	241
AM1PA6070	241
AM1PA7050	241
AM1PA8060	241
AM1PA9050	241
AM1PA9060	241
AM1PA9070	241
ATV340D30N4E	433
ATV340D37N4E	433
ATV340D45N4E	433
ATV340D55N4E	433
ATV340D75N4E	433
ATV630D11M3	433
ATV630D11N4	433
ATV630D15M3	433
ATV630D15N4	433
ATV630D18M3	433
ATV630D18N4	433
ATV630D22M3	433
ATV630D22N4	433
ATV630D30M3	433
ATV630D30N4	433
ATV630D37M3	433
ATV630D37N4	433
ATV630D45M3	433
ATV630D45N4	433
ATV630D55N4	433
ATV630D75N4	433
ATV630D90N4	433
ATV630U07M3	433
ATV630U07N4	433
ATV630U15M3	433
ATV630U15N4	433
ATV630U22M3	433
ATV630U22N4	433
ATV630U30M3	433
ATV630U30N4	433
ATV630U40M3	433
ATV630U40N4	433
ATV630U55M3	433
ATV630U55N4	433
ATV630U75M3	433
ATV630U75N4	433
ATV930D11M3	433
ATV930D11N4	433
ATV930D15M3	433
ATV930D15N4	433
ATV930D18M3	433
ATV930D18N4	433
ATV930D22M3	433
ATV930D22N4	433
ATV930D30M3	433
ATV930D30N4	433
ATV930D37M3	433
ATV930D37N4	433
ATV930D45M3	433

A	Page
ATV930D45N4	433
ATV930D55N4	433
ATV930D75N4	433
ATV930D90N4	433
ATV930U07M3	433
ATV930U07N4	433
ATV930U15M3	433
ATV930U15N4	433
ATV930U22M3	433
ATV930U22N4	433
ATV930U30M3	433
ATV930U30N4	433
ATV930U40M3	433
ATV930U40N4	433
ATV930U55M3	433
ATV930U55N4	433
ATV930U75M3	433
ATV930U75N4	433
AX2DL01	252
AX2DL02	252
AZ1CA04	242

D	Page
DX1AP52	252
DZ5ME5	265, 271
DZ5ME8	265, 271
DZ5ME9	265, 271
DZ5MF6	244
DZ5MF8	244
DZ5MS10	252
DZ6MZ121	244
DZ6MZ151	244
DZ6MZ181	244
DZ6MZ211	244

I	Page
IMT36150	178, 180, 286
IMT36151	275
IMT36152	275
IMT36153	275
IMT36154	275
IMT36155	275
IMT36156	275
IMT36157	275
IMT36158	275
IMT36159	275
IMT36160	275
IMT36161	275
IMT36162	275
IMT36163	275
IMT36164	275
IMT36165	275
IMT36166	275
IMT36167	275
IMT36168	275
IMT36169	275
IMT36170	275
IMT36171	275
IMT36172	178, 285

Index of references

I	Page	N	Page	N	Page
IMT36173	178, 285	NSY17990	454	NSYAC280	201
IMT36179	178, 179, 274, 286	NSY17991	454	NSYAC320	221
IMT36180	178, 179, 286	NSY17992	454	NSYAC360	201, 223
IMT36181	178, 179, 286	NSY17996	454	NSYAC560	221
IMT36182	178, 179, 286	NSY17997	454	NSYAC600	201, 223
IMT36183	178, 179, 286	NSY17998	454	NSYAC840	221, 223
IMT36184	178, 179, 286	NSY1TH	259, 420	NSYADG20M	520
IMT36185	178, 179, 286	NSY2SP124	22, 24, 102, 104, 107	NSYADG2M	520
IMT46026	290	NSY2SP125	24, 104, 107	NSYADG3M	520
IMT46033	290	NSY2SP126	22, 24, 102, 104, 107	NSYADG5M	520
IMT46035	290	NSY2SP128	24, 104, 107	NSYADR200	264
IMT46036	290	NSY2SP144	22, 24, 102, 104, 107	NSYADR200D	264
IMT46064	290	NSY2SP145	24, 104, 107	NSYAEBFZ	201, 221
IMT46071	290	NSY2SP146	24, 104, 107	NSYAECPFLA10	280
IMT46073	290	NSY2SP148	24, 104, 107	NSYAECPFLA25	280
IMT46074	290	NSY2SP164	24, 104, 107	NSYAECPFLA33	280
IMT46101	290	NSY2SP165	24, 104, 107	NSYAECPFLA7	280
IMT46118	290	NSY2SP166	22, 24, 102, 104, 107	NSYAECPFLACA14	284
IMT46149	290	NSY2SP168	22, 24, 102, 104, 107	NSYAECPFLACA18	284
IMT46156	290	NSY2SP184	22, 24, 102, 104, 107	NSYAECPFLACA20	284
IMT46157	290	NSY2SP185	22, 24, 102, 104, 107	NSYAECPFLACA30	284
IMT46158	290	NSY2SP186	22, 24, 102, 104, 107	NSYAECPFLBP	123, 281
IMT46221	290	NSY2SP188	22, 24, 102, 104, 107	NSYAECPFLT25	123, 281
IMT46222	290	NSY2SP204	22, 25, 102, 105, 107	NSYAECPFLT35	123, 281
IMT46223	290	NSY2SP205	22, 25, 102, 105, 107	NSYAECPFLT7	123, 281
IMT46224	290	NSY2SP206	22, 25, 102, 105, 107	NSYAECPKFL10	281
IMT46231	290	NSY2SP208	22, 25, 102, 105, 107	NSYAECPKFL11	281
IMT46232	290	NSY2SP224	25, 105, 107	NSYAECPKFL7A	281
IMT46233	290	NSY2SP225	25, 105, 107	NSYAEDH120S3D	68, 518, 520
IMT46234	290	NSY2SP226	22, 25, 102, 105, 107	NSYAEDH120S3HD	527
IMT46248	290	NSY2SP228	22, 25, 102, 105, 107	NSYAEDH180S3D	68, 518, 520
IMT46286	290	NSY2SPHD124	330	NSYAEDH20TB	175
IMT46293	290	NSY2SPHD126	330	NSYAEDH40TB	175
IMT46918	290	NSY2SPHD164	330	NSYAEDHPLM	525
IMT46919	290	NSY2SPHD166	330	NSYAEDHPLM108	525
IMT46921	290	NSY2SPHD204	330	NSYAEDHPLM3025	525
IMT46922	290	NSY2SPI126	107	NSYAEDHPLM32	525
IMT46923	290	NSY2SPI185	107	NSYAEDHSB	41, 44
IMT46924	290	NSY2SPI186	107	NSYAEDKTB	174
IMT46926	290	NSY2SPI188	107	NSYAE DL1242K31	349, 353
IMT46927	290	NSY2SPI204	107	NSYAE DL1242K33	344, 349, 353
IMT46968	290	NSY2SPI205	107	NSYAE DL1242S3D	67
IMT46969	290	NSY2SPI206	107	NSYAE DL2331S3D	67
IMT46970	290	NSY2SPI208	107	NSYAE DL2433S3D	67
IMT47000	290	NSY2SPI226	107	NSYAE DL3113S3D	67
IMT47001	290	NSY2SPI228	107	NSYAE DL3131AS3D	518
IMT47002	290	NSY2SPIHD124	330	NSYAE DL405K31	349, 353
IMT47004	290	NSY2SPIHD126	330	NSYAE DL405K33	344, 349, 353
ISM71071	178, 285	NSY2SPIHD164	330	NSYAE DL405S3D	67
ISM71072	178, 285	NSY2SPIHD166	330	NSYAE DL421S3D	67
ISM71073	178, 285	NSY2SPIHD204	330	NSYAE DL455K31	349, 353
ISM71074	178, 285	NSY2SPX184	27, 164	NSYAE DL455K33	344, 349, 353
ISM71501	178, 180, 286	NSY2SPX204	27, 164	NSYAE DL455S3D	67
ISM71502	178, 180, 286	NSY2SPX205	27, 164	NSYAE DLB3S3D	67
ISM71503	178, 180, 286	NSY2SPX206	27, 164	NSYAE DLB5S3D	67
ISM71504	178, 180, 286	NSY6G2SP206	343	NSYAE DL DINS3D	68
ISM71505	178, 180, 286	NSY6G2SP208	343	NSYAE LEDF13K31	349, 353
ISM71506	178, 180, 286	NSYAC1080	221	NSYAE LEDF13K33	344, 349, 353
		NSYAC1120	223	NSYAE LEDF13S3D	68

Index of references

N	Page	N	Page	N	Page
NSYAEDLEDF14K31	349, 353	NSYAMFSTB	171, 176	NSYBANPLA53	231
NSYAEDLEDF14K33	344, 349, 353	NSYAMPA1916TB	172, 175	NSYBANPLA54	231
NSYAEDLEDF14S3D	68	NSYAMPA2419TB	172, 175	NSYBANPLA56	231
NSYAEDLEDF9K31	349, 353	NSYAMPA2924TB	172, 175	NSYBANPLA73	231
NSYAEDLEDF9K33	344, 349, 353	NSYAMPA3429TB	172, 175	NSYBANPLA74	231
NSYAEDLEDF9S3D	68	NSYAMPM1916TB	172, 175	NSYBANPLA76	231
NSYAEDLPADS3D	68	NSYAMPM2419TB	172, 175	NSYBCE10	119
NSYAEDLPADS-3DHD	330	NSYAMPM2924TB	172, 175	NSYBCE12	119
NSYAEDLPADS3DK3	349, 353	NSYAMPM3429TB	172, 175	NSYBCE16	119
NSYAEDLS3DC	519	NSYAMRD11155TB	176	NSYBCE4	119
NSYAEDLS3DKDB3	518, 519, 526	NSYAMRD11357TB	176	NSYBCE6	119
NSYAEDLS3DRLN	518	NSYAMRD15357SB	40, 43, 140	NSYBCE8	119
NSYAEDLS3HDRL	527	NSYAMRD16155TB	176	NSYBCME	87, 163, 207
NSYAEDLS3HFDB3	525	NSYAMRD16357TB	176	NSYBCPL	87, 207
NSYAEDLS6S3D	67	NSYAMRD19155TB	176	NSYBE27G	189
NSYAEDLS7S3D	67	NSYAMRD19357TB	176	NSYBGN1054HD	229, 328
NSYAEDLS8S3D	67	NSYAMRD2030	19	NSYBGN1074HD	229, 328
NSYAEDLSD	13, 51, 86	NSYAMRD20357SB	40, 43, 140	NSYBGN12124HD	229, 328
NSYAEDLSDS3D	67	NSYAMRD24155TB	176	NSYBGN12126HD	229, 328
NSYAEDLT6S3D	67	NSYAMRD243515TB	176	NSYBGN1254HD	229, 328
NSYAEDLT8S3D	67	NSYAMRD24357TB	176	NSYBGN1274HD	229, 328
NSYAEDPHD	526	NSYAMRD2530	19	NSYBGN1276HD	229, 328
NSYAEDPLA001	524	NSYAMRD2540	19	NSYBGN15124HD	229, 328
NSYAEDPLA002G	524	NSYAMRD2550	19	NSYBGN15126HD	229, 328
NSYAEDPLA003G	524	NSYAMRD29155TB	176	NSYBGN1574HD	229, 328
NSYAEDPLA004	524	NSYAMRD293515TB	176	NSYBGN1576HD	229, 328
NSYAEDPLA005	524	NSYAMRD29357TB	176	NSYBGN2074HD	229, 328
NSYAEDPLM108	525	NSYAMRD3030	19	NSYBGN774HD	229, 328
NSYAEDRS3DPA6	69, 300	NSYAMRD30357SB	40, 43, 140	NSYBGN776HD	229, 328
NSYAEDRSCST	14, 58, 69, 155, 300	NSYAMRD3040	19	NSYBICRN	520, 525
NSYAEDS20TB	174	NSYAMRD3050	19	NSYBL27	189
NSYAEDS40TB	174	NSYAMRD34155TB	176	NSYBLKH123	129
NSYAEDS60TB	174	NSYAMRD343515TB	176	NSYBN204	263, 270
NSYAEDSB520TB	174	NSYAMRD34357TB	176	NSYBN206	263, 270
NSYAEDSBSB	41, 44	NSYAMRD36	19	NSYBN404	263, 270
NSYAEDST820TB	174	NSYAMRD40357SB	40, 43, 140	NSYBN406	263, 270
NSYAEDSTSB	41, 44	NSYAMRD43	19	NSYBN408	263, 270
NSYAEFAHLBSC	14, 58, 64, 79, 80	NSYAMRD48	19	NSYBN606	263, 270
NSYAEFPFS3DW100	64	NSYAMRD50357SB	40, 43	NSYBN608	263, 270
NSYAEFPFS3DW20	64	NSYAMRD54	19	NSYBN610	263, 270
NSYAEFPFS3DW30	64	NSYAMRD60357SB	40, 43	NSYBP126	24, 104
NSYAEFPFS3DW40	64	NSYAMRD64	19	NSYBP128	24, 104
NSYAEFPFS3DW50	64	NSYAMRD80357SB	40, 43	NSYBP146	24, 104
NSYAEFPFS3DW60	64	NSYASPLA001	524	NSYBP148	24, 104
NSYAEFPFS3DW80	64	NSYASPLA002	524	NSYBP166	24, 104
NSYAEFPFSB	41, 44	NSYASPLA003	524	NSYBP168	24, 104
NSYAEFPFSBX	140, 141	NSYASPLM	525	NSYBP1810	24, 104
NSYAEFPFSC	12, 14, 50, 58, 64, 79, 80	NSYASPLM32	525	NSYBP1812	24, 104
NSYAEFPFXSC	14, 58, 64, 80, 330	NSYATM27	186	NSYBP184	24, 104
NSYAEFTB	171, 175	NSYAVD1U1450	457	NSYBP186	24, 104
NSYAELYTCRG8	14, 58, 66, 85, 351, 354	NSYAVD1U480	457	NSYBP188	24, 104
NSYAELYTCRXG8	156	NSYAVD1U550M48	457	NSYBP2010	25, 105
NSYAEPMZM	201	NSYAVD1U970	457	NSYBP2012	25, 105
NSYAEUBU41SC	61, 84	NSYAVG2U300	457	NSYBP2016	25, 105
NSYAEUBU61SC	61, 84	NSYAZ3PLA	221	NSYBP203	25, 105
NSYAEUBUSC	61, 84	NSYAZ4PLA	221	NSYBP204	25, 105
NSYAMCSF	241, 244, 271	NSYB204	263, 270	NSYBP206	25, 105
NSYAMFSB	41, 44, 141	NSYB404	263, 270	NSYBP207	521
		NSYB406	263, 270	NSYBP208	25, 105

Index of references

N	Page	N	Page	N	Page
NSYBP2210	25, 105	NSYCAF2910	448	NSYCDBPLM	199, 525
NSYBP2212	25, 105	NSYCAF291T	448	NSYCDL	293
NSYBP224	25, 105	NSYCAF92	448	NSYCDP36	127
NSYBP226	25, 105	NSYCAF92M	448	NSYCDP38	127
NSYBP228	25, 105	NSYCAG104X95LM	460	NSYCDS	293
NSYBPC3	291	NSYCAG108LP	456	NSYCEA14E	528
NSYBPC5	291	NSYCAG110X46M	460	NSYCEA22E	463, 528
NSYBPHD12122D	527	NSYCAG114LPF	457	NSYCEA35W230VL	467
NSYBPHD126	527	NSYCAG125LPF	215, 448, 449, 455	NSYCEA35W230VLE	467
NSYBPHD128	527	NSYCAG12LPH1	174, 461	NSYCEA36	463, 467, 528
NSYBPHD1612	527	NSYCAG12LPH2	174, 461	NSYCEA50	463, 467, 528
NSYBPHD166	527	NSYCAG130X110LM	460	NSYCEA70W230VL	467
NSYBPHD168	527	NSYCAG170X190LM	460	NSYCEA80	463, 467, 528
NSYBPHD208	527	NSYCAG180X62M	460	NSYCEFILS	367
NSYBPI1810	108	NSYCAG19LP	461	NSYCEJ	119
NSYBPI2010	108	NSYCAG216X62M	460	NSYCEJD	282
NSYBPI206	108	NSYCAG223LFHD	333, 450	NSYCEJD11	282
NSYBPI208	108	NSYCAG223LPF	335, 448, 449, 455	NSYCEJD13	282
NSYBPI2210	108	NSYCAG291LPF	448, 449, 455	NSYCEJD16	282
NSYBPI228	108	NSYCAG317X120M	460	NSYCEJD18	282
NSYBRF12PLAG	33, 227	NSYCAG317X91M	460	NSYCEJD20	282
NSYBRF17PLAG	33, 227	NSYCAG33LP	461	NSYCEJD22	282
NSYBRF21PLAG	33, 227	NSYCAG35LP	209, 461	NSYCEJD24	282
NSYBRF26PLAG	33, 227	NSYCAG38LP	461	NSYCEJD26	282
NSYBRF8PLAG	33, 227	NSYCAG417X120M	460	NSYCEJD28	282
NSYBTACRNG100	520	NSYCAG45LP	461	NSYCEJD3	282
NSYBTACRNG120	520	NSYCAG78LPF	457	NSYCEJD30	282
NSYBTACRNG140	520	NSYCAG92LPF	448	NSYCEJD5	282
NSYBTACRNG80	520	NSYCAP125LE	455	NSYCEJD7	282
NSYBTAS3D100	518, 519, 526	NSYCAP125LXF	449, 455	NSYCEJD9	282
NSYBTAS3D120	518, 519	NSYCAP125LZF	449, 455	NSYCEJDL0	283
NSYBTAS3D140	518	NSYCAP223LE	454, 455	NSYCEJDL12	283
NSYBTAS3D60	518, 519, 526	NSYCAP223LXF	449, 455	NSYCEJDL13	283
NSYBTAS3D65	518	NSYCAP223LZF	449, 455	NSYCEJDL14	283
NSYBTAS3D70	518, 519, 526	NSYCAP291LE	454, 455	NSYCEJDL15	283
NSYBTAS3D80	518, 519, 526	NSYCAP291LXF	449, 455	NSYCEJDL16	283
NSYBTAS3D90	518	NSYCAP291LZF	449, 455	NSYCEJDL17	283
NSYCAAPV	448	NSYCBCCR	86	NSYCEJDL18	283
NSYCAAPVHD	333, 450	NSYCBCMPLAG	226	NSYCEJDL19	283
NSYCAC228RMF	461	NSYCBXHCRN	155	NSYCEJDL20	283
NSYCAF104X95X	460	NSYCCASTE	499	NSYCEJDL21	283
NSYCAF108	456	NSYCCOBY230VID	497, 499	NSYCEJDS0	283
NSYCAF125	448	NSYCCOBY120VID	497, 499	NSYCEJDS10	283
NSYCAF125L55	449, 455	NSYCCOBY230VID	497, 499	NSYCEJDS11	283
NSYCAF125M	448	NSYCCOBY30VID	497	NSYCEJDS2	283
NSYCAF125O	448	NSYCCOTH120VID	497, 499	NSYCEJDS3	283
NSYCAF125T	448	NSYCCOTH230VID	497, 499	NSYCEJDS4	283
NSYCAF130X110X	460	NSYCCOTH30VID	497, 499	NSYCEJDS5	283
NSYCAF170X190X	460	NSYCCOTH	496, 498	NSYCEJDS6	283
NSYCAF190	333, 334, 335, 450	NSYCCOTHCF	496, 498	NSYCEJDS7	283
NSYCAF223	448	NSYCCOTH	496, 498	NSYCEJDS8	283
NSYCAF223L55	449, 455	NSYCCOTHDF	496, 498	NSYCEJDS9	283
NSYCAF223M	448	NSYCCOTHI	496, 498	NSYCEK	119
NSYCAF223O	448	NSYCCOTH	496, 498	NSYCEP	303
NSYCAF223T	333, 335, 448, 450	NSYCCOTHOF	496, 498	NSYCEPLMAG	29, 202
NSYCAF228R	461	NSYCCSDF10	525	NSYCEPLMBG	29, 202
NSYCAF291	448	NSYCCSDF12	525	NSYCEPLMCG	29, 202
NSYCAF291L55	449, 455	NSYCCSDF16	525	NSYCEW1K	465, 467, 528, 529
NSYCAF291M	448	NSYCCSDF8	525	NSYCEW1K8	465, 467, 528, 529

Index of references

N	Page	N	Page	N	Page
NSYCEW-2100W230VL	467	NSYCMT5005	398, 401	NSYCR150WU3	495
NSYCEW2K5	465, 467, 528, 529	NSYCMT5010	398, 401	NSYCR170W230VVC	494
NSYCEW2K5R	466, 467, 528, 529	NSYCMT5015	398, 401	NSYCR20WU1	495
NSYCEW-3150W230VL	467	NSYCMT5020	398, 401	NSYCR20WU1C	494
NSYCEW3K5	465, 467, 528, 529	NSYCMT8005	398, 401	NSYCR20WU2	495
NSYCEW4K5	465, 467, 528, 529	NSYCMT8010	398, 401	NSYCR20WU2C	494
NSYCEW6K	466, 467, 528, 529	NSYCMT8015	398, 401	NSYCR20WU3	495
NSYCEW6K2P4	466, 467, 528, 529	NSYCMT8020	398, 401	NSYCR250W115VV	495
NSYCEWX1K	465, 467, 528, 529	NSYCMUCC50	398, 402	NSYCR250W230VV	495
NSYCEWX1K8	465, 467, 528, 529	NSYCMUCC80	398, 402	NSYCR400W115VV	495
NSYCEWX2K5	465, 467, 528, 529	NSYCMUCP50	398, 402	NSYCR400W230VV	495
NSYCFP100	288	NSYCMUCP80	398, 402	NSYCR50WU1C	494
NSYCFP60	288	NSYCMUCPAD87	402	NSYCR50WU2C	494
NSYCFP80	288	NSYCMUCR50	398, 402	NSYCR50WU3C	494
NSYCF5126	288	NSYCMUCR80	398, 402	NSYCR55WU1	495
NSYCF5128	288	NSYCMUIA50	398, 401	NSYCR55WU2	495
NSYCF596	288	NSYCMUIA80	398, 401	NSYCR55WU3	495
NSYCF598	288	NSYCMUMA50	398, 401	NSYCRN106250	16, 76
NSYCGHF12	384	NSYCMUMA80	398, 401	NSYCRN106250P	16, 76
NSYCGHF16	384	NSYCMUMC50	398, 401	NSYCRN106250T	16, 76
NSYCGHF20	384	NSYCMUMC80	398, 401	NSYCRN106300	16, 76
NSYCGHF25	384	NSYCMUMR50	398, 401	NSYCRN106300P	16, 76
NSYCGHF32	384	NSYCMUMR80	398, 401	NSYCRN106300T	16, 76
NSYCGHF40	384	NSYCMUTC50	398, 402	NSYCRN108250	16, 76
NSYCGSP16	142, 178, 181, 287	NSYCMUTC80	398, 402	NSYCRN108250P	16, 76
NSYCGSP20	142, 178, 181, 287	NSYCN20	263, 310	NSYCRN108250T	16, 76
NSYCGSP25	142, 178, 181, 287	NSYCN40	263, 310	NSYCRN108300	16, 76
NSYCGSP32	142, 178, 181, 287	NSYCN9M625	115, 269, 374	NSYCRN108300P	16, 76
NSYCGSP40	142, 178, 181, 287	NSYCNFM6	270	NSYCRN108300T	16, 76
NSYCGX12	143, 287	NSYCNFM8	270	NSYCRN22150	16, 76
NSYCGX12H	143, 287	NSYCNM6	251, 270	NSYCRN23150	16, 76
NSYCGX16	143, 287	NSYCNM8	251, 270	NSYCRN252150	16, 76
NSYCGX16H	143, 287	NSYCNOH123	129	NSYCRN252150P	16, 76
NSYCGX20	143, 287	NSYCNT20	263, 310	NSYCRN325150	16, 76
NSYCGX20H	143, 287	NSYCNT40	263, 310	NSYCRN325150P	16, 76
NSYCGX25	143, 287	NSYCOCN80	79, 82	NSYCRN325150T	16, 76
NSYCGX25H	143, 287	NSYCOCNS1400	79, 82, 154, 203, 382	NSYCRN325200	16, 76
NSYCGX32	143, 287	NSYCOCNS1800	82, 154, 203, 382	NSYCRN325200P	16, 76
NSYCGX32H	143, 287	NSYCP17	291	NSYCRN325200T	16, 76
NSYCGX40	143, 287	NSYCP29	291	NSYCRN33150	16, 76
NSYCGX40H	143, 287	NSYCP37	291	NSYCRN33150P	16, 76
NSYCHCOA	79, 82	NSYCP50	291	NSYCRN33150T	16, 76
NSYCHCOB	79, 82	NSYCP17	291	NSYCRN33200	16, 76
NSYCHCOC	79, 82	NSYCP29	291	NSYCRN33200P	16, 76
NSYCHCOD	79, 82	NSYCP37	291	NSYCRN33200T	16, 76
NSYCL1242ECSX	155	NSYCP50	291	NSYCRN34200	16, 76
NSYCL220CRN	86	NSYCP17	291	NSYCRN34200T	16, 76
NSYCL27L405	188	NSYCP29	291	NSYCRN345150	16, 76
NSYCL27M	188	NSYCP37	291	NSYCRN43150	16, 76
NSYCL405CRN	86	NSYCP50	291	NSYCRN43150P	16, 76
NSYCL405CSX	155	NSYCP17	291	NSYCRN43150T	16, 76
NSYCL610CSX	155	NSYCP29	291	NSYCRN43200	16, 76
NSYCLL405CRN	86	NSYCP37	291	NSYCRN43200P	16, 76
NSYCMACS50	402	NSYCP50	291	NSYCRN43200T	16, 76
NSYCMACS80	402	NSYPTS17	291	NSYCRN44200	16, 76
NSYCMBPT	400	NSYPTS29	291	NSYCRN44200P	16, 76
NSYCMT2560110	400	NSYPTS37	291	NSYCRN44200T	16, 76
		NSYPTS50	291	NSYCRN46250	16, 76
		NSYCR100WU1	495	NSYCRN46250P	16, 76
		NSYCR100WU1C	494		
		NSYCR100WU2	495		
		NSYCR100WU2C	494		
		NSYCR100WU3	495		
		NSYCR100WU3C	494		
		NSYCR10WU1	495		
		NSYCR10WU1C	494		
		NSYCR10WU2	495		
		NSYCR10WU2C	494		
		NSYCR150WU1	495		
		NSYCR150WU2	495		
		NSYCR150WU2C	494		

Index of references

N	Page	N	Page	N	Page
NSYCRN46250T	16, 76	NSYCRN88200	16, 76	NSYCU1460W230VR	485
NSYCRN46300	16, 76	NSYCRN88200P	16, 76	NSYCU1650W230VL	485
NSYCRN46300T	16, 76	NSYCRN88200T	16, 76	NSYCU1650W230VR	485
NSYCRN54150	16, 75, 76	NSYCRN88300	16, 76	NSYCU1800W400VL	485
NSYCRN54150P	16, 76	NSYCRN88300P	16, 76	NSYCU1K	475, 484, 485, 530, 532
NSYCRN54150T	16, 76	NSYCRN88300T	16, 76	NSYCU1K2	475, 484, 530, 532
NSYCRN54200	16, 76	NSYCRNCGPSTDSB	520	NSYCU1K22P4	475, 484, 530, 532
NSYCRN54200P	16, 76	NSYCRNG1010300D	16, 76	NSYCU1K2P4	475, 484, 530, 532
NSYCRN54200T	16, 76	NSYCRNG1010300T	16, 76	NSYCU1K2P4UL	475, 484, 530, 532
NSYCRN54250	16, 76	NSYCRNG1012300D	16, 76	NSYCU1K2R	478, 484, 534, 535
NSYCRN54250P	16, 76	NSYCRNG1012400D	16, 76	NSYCU1K2RUL	478, 484, 534, 535
NSYCRN54250T	16, 76	NSYCRNG106400	16, 76	NSYCU1K2UL	475, 484, 530, 532
NSYCRN55250	16, 76	NSYCRNG106400T	16, 76	NSYCU1K5R	479, 484, 534, 535
NSYCRN55250P	16, 76	NSYCRNG108400	16, 76	NSYCU1K5RUL	479, 484, 534, 535
NSYCRN55250T	16, 76	NSYCRNG108400T	16, 76	NSYCU1K6	475, 484, 530, 532
NSYCRN64150	16, 76	NSYCRNG1210300D	16, 76	NSYCU1K62P4	475, 484, 530, 532
NSYCRN64150P	16, 76	NSYCRNG1210400D	16, 76	NSYCU1K62P4UL	475, 484, 530, 532
NSYCRN64150T	16, 76	NSYCRNG1212300D	16, 76	NSYCU1K6UL	475, 484, 530, 532
NSYCRN64200	16, 76	NSYCRNG1212400D	16, 76	NSYCU1KUL	475, 484, 530, 532
NSYCRN64200P	16, 76	NSYCRNG126300	16, 76	NSYCU2000W400VR	485
NSYCRN64200T	16, 76	NSYCRNG126300T	16, 76	NSYCU240W230VL	485
NSYCRN64250	16, 76	NSYCRNG126400	16, 76	NSYCU2450W400VR	485
NSYCRN64250P	16, 76	NSYCRNG126400T	16, 76	NSYCU2500W400VL	485
NSYCRN64250T	16, 76	NSYCRNG128300	16, 76	NSYCU2K	475, 484, 531, 533
NSYCRN65150	16, 76	NSYCRNG128300T	16, 76	NSYCU2K3P4	476, 484, 531, 533
NSYCRN65150P	16, 76	NSYCRNG128400	16, 76	NSYCU2K3P4R	479, 484, 534, 535
NSYCRN65150T	16, 76	NSYCRNG128400T	16, 76	NSYCU2K3P4RUL	479, 484, 534, 535
NSYCRN65200	16, 76	NSYCRNG1410300D	16, 76	NSYCU2K3P4UL	476, 484, 531, 533
NSYCRN65200P	16, 76	NSYCRNG810300D	16, 76	NSYCU2KR	479, 484, 534, 535
NSYCRN65200T	16, 76	NSYCRNG812300D	16, 76	NSYCU2KUL	475, 484, 531, 533
NSYCRN65250	16, 76	NSYCRNG86400	16, 76	NSYCU300H	474, 484, 530, 532
NSYCRN65250P	16, 76	NSYCRNG86400T	16, 76	NSYCU3100W400VR	485
NSYCRN65250T	16, 76	NSYCRNGSDR	243	NSYCU370W230VL	485
NSYCRN66200	16, 76	NSYCRP1W120VTVC	495	NSYCU3K3P4	477, 484, 531, 533
NSYCRN66200P	16, 76	NSYCRP1W230VTVC	495	NSYCU3K3P4R	479, 484, 534, 535
NSYCRN66200T	16, 76	NSYCRS100W240V	491	NSYCU3K3P4RUL	479, 484, 534, 535
NSYCRN66250	16, 76	NSYCRS10W240V	491	NSYCU3K3P4UL	477, 484, 531, 533
NSYCRN66250P	16, 76	NSYCRS200W230V	495	NSYCU400	474, 484, 530, 532
NSYCRN66250T	16, 76	NSYCRS200W240V	491	NSYCU4000W400VL	485
NSYCRN66300	16, 76	NSYCRS25W240V	491	NSYCU400R	478, 484, 534, 535
NSYCRN66300P	16, 76	NSYCRS50W240V	491	NSYCU400RUL	478, 484, 534, 535
NSYCRN66300T	16, 76	NSYCS200PLM	29, 199, 208	NSYCU400UL	474, 484, 530, 532
NSYCRN68300	16, 76	NSYCS300PLM	29, 208	NSYCU4K3P4	477, 484, 531, 533
NSYCRN68300T	16, 76	NSYCS400PLM	29, 208	NSYCU4K3P4R	479, 484, 534, 535
NSYCRN75200	16, 76	NSYCS500PLM	29, 208	NSYCU4K3P4RUL	479, 484, 534, 535
NSYCRN75200P	16, 76	NSYCS600PLM	29, 208	NSYCU4K3P4UL	477, 484, 531, 533
NSYCRN75200T	16, 76	NSYCS800PLM	29, 208	NSYCU600	474, 484, 530, 532
NSYCRN75250	16, 76	NSYCSA57	339	NSYCU600UL	474, 484, 530, 532
NSYCRN75250P	16, 76	NSYCSA68	339	NSYCU6K3P4	477, 484, 531, 533
NSYCRN75250T	16, 76	NSYCSA810	339	NSYCU760W230VL	485
NSYCRN86200	16, 76	NSYCS	108	NSYCU760W230VR	485
NSYCRN86200P	16, 76	NSYCS	344	NSYCU800	474, 484, 530, 532
NSYCRN86200T	16, 76	NSYCSSF	521	NSYCU800R	478, 484, 534, 535
NSYCRN86250	16, 76	NSYCSSFHD	527	NSYCU800RUL	478, 484, 534, 535
NSYCRN86250P	16, 76	NSYCTL500DLP2	230, 236	NSYCU800UL	474, 484, 530, 532
NSYCRN86250T	16, 76	NSYCTL500DLPG	230, 236	NSYCUAD	478
NSYCRN86300	16, 76	NSYCTL750DLP2	230, 236	NSYCUB1100W230S	485
NSYCRN86300P	16, 76	NSYCTL750DLPG	230, 236	NSYCUB1100W400S	485
NSYCRN86300T	16, 76	NSYCU1050W230VR	485	NSYCUB1500W230S	485

Index of references

N	Page	N	Page	N	Page
NSYCUB1500W400S	485	NSYCUSP0001	530	NSYCUSP0067	532
NSYCUB2200W230S	485	NSYCUSP0002	530, 536	NSYCUSP0068	532
NSYCUB2200W400S	485	NSYCUSP0003	530, 536	NSYCUSP0069	532
NSYCUB2700W230S	485	NSYCUSP0004	530, 536	NSYCUSP0070	532, 533
NSYCUB2700W400S	485	NSYCUSP0005	530	NSYCUSP0071	533
NSYCUD1K1T1K5	485	NSYCUSP0006	530, 531, 536	NSYCUSP0072	535
NSYCUD1K2T2K	485	NSYCUSP0007	531, 536	NSYCUSP0073	535
NSYCUD3KT4K	485	NSYCUSP0008	534	NSYCUSP0074	535
NSYCUD400	485	NSYCUSP0009	534	NSYCUSP0075	535
NSYCUD600	485	NSYCUSP0010	534	NSYCUSP0076	528
NSYCUD800T1K	485	NSYCUSP0011	534	NSYCUSP0077	528
NSYCUE1100W230L	485	NSYCUSP0012	534	NSYCUSP0078	528
NSYCUE1400W230L	485	NSYCUSP0013	530	NSYCUSP0079	528
NSYCUE1400W230R	485	NSYCUSP0014	530	NSYCUSP0080	528
NSYCUE1400W400L	485	NSYCUSP0015	530	NSYCUSP0081	528
NSYCUE1800W400L	485	NSYCUSP0016	530	NSYCUSP0082	528
NSYCUE1800W400R	485	NSYCUSP0017	530	NSYCUSP0084	528
NSYCUF1K1T2KS	485	NSYCUSP0018	530	NSYCUSP0085	532
NSYCUF1K2T2KR	485	NSYCUSP0019	530	NSYCUSP0086	532
NSYCUF1KT2K	485	NSYCUSP0020	531	NSYCUSP0087	532
NSYCUF3KT4K	485	NSYCUSP0021	531	NSYCUSP0088	532, 533
NSYCUF3KT4KR	485	NSYCUSP0022	531	NSYCUSP0089	533
NSYCUF400	485	NSYCUSP0023	534	NSYCUSP0090	535
NSYCUF400R	485	NSYCUSP0024	534	NSYCUSP0091	535
NSYCUF600	485	NSYCUSP0025	534	NSYCUSP0092	535
NSYCUF6K	485	NSYCUSP0026	534	NSYCUSP0093	535
NSYCUF800R	485	NSYCUSP0027	534	NSYCUSP0094	528
NSYCUF800T1K	485	NSYCUSP0028	534	NSYCUSP0095	528
NSYCUFX1K1T2KS	485	NSYCUSP0029	534	NSYCUSP0099	532, 533, 535
NSYCUFX1K2T2K	485	NSYCUSP0030	528	NSYCUSP0100	528, 529, 536
NSYCUFX1K2T2KR	485	NSYCUSP0031	528	NSYCUSP0101	532, 536
NSYCUFX3KT4K	485	NSYCUSP0032	528	NSYCUSP0102	532
NSYCUFX3KT4KR	485	NSYCUSP0033	528	NSYCUSP0103	532, 536
NSYCUFX400	485	NSYCUSP0034	528	NSYCUSP0104	533, 535, 536
NSYCUFX400R	485	NSYCUSP0035	528	NSYCUSP0105	533, 535, 536
NSYCUFX600	485	NSYCUSP0036	528	NSYCUSP0106	535
NSYCUFX6K	485	NSYCUSP0037	528	NSYCUSP0107	529
NSYCUFX800R	485	NSYCUSP0038	528	NSYCUSP0108	529
NSYCUFX800T1K	485	NSYCUSP0041	528	NSYCUSP0109	529
NSYCUHD1K	481, 484, 536	NSYCUSP0042	528, 530, 536	NSYCUSP0111	528
NSYCUHD1K2P4	481, 484, 536	NSYCUSP0043	528, 530, 534, 536	NSYCUSP0112	528
NSYCUHD1K6	481, 484, 536	NSYCUSP0044	528, 530, 534, 536	NSYCUSP0113	528
NSYCUHD1K62P4	481, 484, 536	NSYCUSP0047	534	NSYCUSP0114	529
NSYCUHD2K3P4	481, 484, 536	NSYCUSP0049	534	NSYCUSP0115	529
NSYCUHD3K3P4	481, 484, 536	NSYCUSP0051	534	NSYCUSP0117	529
NSYCUHD400	480, 484, 536	NSYCUSP0053	528	NSYCUSP0118	532
NSYCUHD4K3P4	481, 484, 536	NSYCUSP0054	530	NSYCUSP0119	532
NSYCUHD600	480, 484, 536	NSYCUSP0055	530, 536	NSYCUSP0120	532, 533
NSYCUHD800	480, 484, 536	NSYCUSP0056	530, 536	NSYCUSP0121	535
NSYCUS1K12P4UL	482, 484, 537	NSYCUSP0057	530, 536	NSYCUSP0122	535
NSYCUS1K1UL	482, 484, 537	NSYCUSP0058	530	NSYCUSP0123	535
NSYCUS1K52P4UL	482, 484, 537	NSYCUSP0059	530, 534, 536, 537	NSYCUSP0124	529
NSYCUS1K5UL	482, 484, 537	NSYCUSP0060	531, 534	NSYCUSP0125	529
NSYCUS2K3P4UL	483, 484, 537	NSYCUSP0061	531, 534, 536	NSYCUSP0126	532
NSYCUS2K53P4UL	483, 484, 537	NSYCUSP0062	531, 534, 536, 537	NSYCUSP0127	532
NSYCUS2K5UL	483, 484, 537	NSYCUSP0063	531, 534, 536, 537	NSYCUSP0128	533
NSYCUS2KUL	483, 484, 537	NSYCUSP0064	534	NSYCUSP0129	535
NSYCUS3K23P4UL	483, 484, 537	NSYCUSP0065	534	NSYCUSP0130	537
NSYCUS3K2UL	483, 484, 537	NSYCUSP0066	532	NSYCUSP0131	537

Index of references

N	Page	N	Page	N	Page
NSYCUSP0132	537	NSYCUX1K2P4	475, 484, 530, 532	NSYCVF65M230PF	456
NSYCUSP0133	537	NSYCUX1K2P4UL	475, 484, 530, 532	NSYCVF850M115PF	447, 459
NSYCUSP0134	537	NSYCUX1K2R	478, 484, 534, 535	NSYCVF850M230PF	447, 449, 455, 459
NSYCUSP0135	537	NSYCUX1K2UL	475, 484, 530, 532	NSYCVF850M400PF	447
NSYCUSP0136	528, 530, 531, 534, 536, 537	NSYCUX1K5R	479, 484, 534, 535	NSYCVF85M115PF	447
NSYCUSP0137	528, 531, 534, 536, 537	NSYCUX1K6	475, 484, 530, 532	NSYCVF85M230PF	447, 449, 455
NSYCUSP0138	528, 530, 531, 536, 537	NSYCUX1K62P4	475, 484, 530, 532	NSYCVF85M24DPF	447
NSYCUSP0139	531, 537	NSYCUX1K62P4UL	475, 484, 530, 532	NSYCVF85M48DPF	447
NSYCUSP0140	537	NSYCUX1K6UL	475, 484, 530, 532	NSYCW33	302
NSYCUSP0141	537	NSYCUX1KUL	475, 484, 530, 532	NSYCW44	302
NSYCUSP0142	537	NSYCUX2K	475, 484, 531, 533	NSYCW45	302
NSYCUSP0143	537	NSYCUX2K3P4	476, 484, 531, 533	NSYCW46	302
NSYCUSP0144	532, 533, 535, 537	NSYCUX2K3P4R	479, 484, 534, 535	NSYCW54	302
NSYCUSP0145	537	NSYCUX2K3P4UL	476, 484, 531, 533	NSYCW55	302
NSYCUSP0146	537	NSYCUX2KR	479, 484, 534, 535	NSYCW56	302
NSYCUSP0147	533, 535, 537	NSYCUX2KUL	475, 484, 531, 533	NSYCW65	302
NSYCUSP0148	533, 535, 537	NSYCUX3K3P4	477, 484, 531, 533	NSYCW66	302
NSYCUSP0149	537	NSYCUX3K3P4R	479, 484, 534, 535	NSYCW86	302
NSYCUSP0150	537	NSYCUX3K3P4UL	477, 484, 531, 533	NSYDB1010M	10, 36
NSYCUSP0151	537	NSYCUX400	474, 484, 530, 532	NSYDB1510M	10, 36
NSYCUSP0152	537	NSYCUX400R	478, 484, 534, 535	NSYDB2015M	10, 36
NSYCUSP0153	536	NSYCUX4K3P4	477, 484, 531, 533	NSYDB88M	10, 36
NSYCUSP0154	536	NSYCUX4K3P4R	479, 484, 534, 535	NSYDBN1010	10, 36
NSYCUSP0155	536	NSYCUX4K3P4UL	477, 484, 531, 533	NSYDBN1510	10, 36
NSYCUSP0156	536	NSYCUX600	474, 484, 530, 532	NSYDBN2015	10, 36
NSYCUSP0157	536	NSYCUX600UL	474, 484, 530, 532	NSYDBN2520	10, 36
NSYCUSP0158	536	NSYCUX800	474, 484, 530, 532	NSYDBN3025	10, 36
NSYCUSP0159	536	NSYCUX800R	478, 484, 534, 535	NSYDBN88	10, 36
NSYCUSP0160	536	NSYCUX800UL	474, 484, 530, 532	NSYDCD2412	282
NSYCUSP0161	536	NSYCV114M	457	NSYDCD244	282
NSYCUSP0162	536	NSYCV178M	457	NSYDCD248	282
NSYCUSP0163	536	NSYCVAC100	457	NSYDCD249	282
NSYCUSP0164	536	NSYCVF156M115	456	NSYDCE10	119
NSYCUSP0165	536	NSYCVF156M230	456	NSYDCE12	119
NSYCUSP0166	537	NSYCVF165M115PF	447	NSYDCE168	282
NSYCUSP0167	536	NSYCVF165M230PF	447, 449, 455	NSYDCE2410	282
NSYCUSP0168	536	NSYCVF165M24DPF	447	NSYDCE244	282
NSYCUSP0169	536	NSYCVF165M48DPF	447	NSYDCE6	119
NSYCUSP0170	536	NSYCVF170M115	457	NSYDCE8	119
NSYCUSP0171	536	NSYCVF170M230	457	NSYDCM20	128, 298
NSYCUSP0172	534	NSYCVF300M115PF	447	NSYDCRN106	520
NSYCUSP0173	532	NSYCVF300M230PF	447, 449, 455	NSYDCRN108	520
NSYCUSP0174	532	NSYCVF300M24DPF	447	NSYDCRN22	520, 525
NSYCUSP0177	528	NSYCVF300M48DPF	447	NSYDCRN23	520, 525
NSYCUSP0181	528	NSYCVF35M115	456	NSYDCRN2520	520, 525
NSYCUSP0184	528	NSYCVF35M230	456	NSYDCRN3025	520, 525
NSYCUSX1K12P4UL	482, 484, 537	NSYCVF38M115PF	447	NSYDCRN3045	520, 525
NSYCUSX1K1UL	482, 484, 537	NSYCVF38M230PF	447	NSYDCRN33	520, 525
NSYCUSX1K52P4UL	482, 484, 537	NSYCVF38M24DPF	447	NSYDCRN34	520, 525
NSYCUSX1K5UL	482, 484, 537	NSYCVF38M48DPF	447	NSYDCRN43	520, 525
NSYCUSX2K3P4UL	484, 537	NSYCVF54M230MM2	456	NSYDCRN44	520, 525
NSYCUSX2K53P4UL	484, 537	NSYCVF550M115FB	333, 450	NSYDCRN46	520, 525
NSYCUSX2K5UL	484, 537	NSYCVF550M230FB	333, 450	NSYDCRN54	520
NSYCUSX2KUL	484, 537	NSYCVF550M24FB	333, 450	NSYDCRN55	520, 525
NSYCUSX3K23P4UL	484, 537	NSYCVF560M115PF	447, 459	NSYDCRN64	520
NSYCUSX3K2UL	484, 537	NSYCVF560M230PF	447, 449, 455, 459	NSYDCRN65	520
NSYCUX1K	475, 484, 530, 532	NSYCVF570M115MF	456	NSYDCRN66	520, 525
NSYCUX1K2	475, 484, 530, 532	NSYCVF575M230MF	456	NSYDCRN68	520, 525
NSYCUX1K22P4	475, 484, 530, 532	NSYCVF65M115PF	456	NSYDCRN75	520

Index of references

N	Page	N	Page	N	Page
NSYDCRN86	520, 525	NSYDPLA105HG	524	NSYDS3D106L	518
NSYDCRN88	520	NSYDPLA107G	524	NSYDS3D106R	518
NSYDCRNG105L	520	NSYDPLA107HG	524	NSYDS3D108	518, 526
NSYDCRNG105R	520	NSYDPLA125G	524	NSYDS3D1210	518
NSYDCRNG106	520	NSYDPLA125HG	524	NSYDS3D125L	518
NSYDCRNG106L	520	NSYDPLA127G	524	NSYDS3D125R	518
NSYDCRNG106R	520	NSYDPLA127HG	524	NSYDS3D126	518
NSYDCRNG108	520	NSYDPLA155G	524	NSYDS3D126L	518
NSYDCRNG125L	520	NSYDPLA155HG	524	NSYDS3D126R	518
NSYDCRNG125R	520	NSYDPLA157G	524	NSYDS3D128	518
NSYDCRNG126	520	NSYDPLA157HG	524	NSYDS3D145L	518
NSYDCRNG126L	520	NSYDPLA3	230	NSYDS3D145R	518
NSYDCRNG126R	520	NSYDPLA4	230	NSYDS3D32	518, 526
NSYDCRNG128	520	NSYDPLA55G	524	NSYDS3D325	518
NSYDCRNG145L	520	NSYDPLA55HG	524	NSYDS3D33	518, 526
NSYDCRNG145R	520	NSYDPLA57G	524	NSYDS3D34	518
NSYDCRNG85L	520	NSYDPLA57HG	524	NSYDS3D43	518, 526
NSYDCRNG85R	520	NSYDPLA6	230	NSYDS3D44	518, 526
NSYDCRNG86	520	NSYDPLA75G	524	NSYDS3D46	518
NSYDCRNG86L	520	NSYDPLA75HG	524	NSYDS3D53	518
NSYDCRNG86R	520	NSYDPLA77G	524	NSYDS3D54	518, 526
NSYDHLT8060	260	NSYDPLA77HG	524	NSYDS3D55	518
NSYDHLT8080	260	NSYDPLM108G	525	NSYDS3D64	518, 526
NSYDHSF	521, 522	NSYDPLM108TG	525	NSYDS3D65	518
NSYDHSM2D	522	NSYDPLM200	29, 208, 392	NSYDS3D66	518, 526
NSYDLLSDF	525	NSYDPLM250	29, 208, 392	NSYDS3D68	518
NSYDLS10	525	NSYDPLM300	29, 208, 392	NSYDS3D75	518, 526
NSYDLS12	525	NSYDPLM3025G	525	NSYDS3D810	518
NSYDLS12	525	NSYDPLM3025TG	525	NSYDS3D85L	518
NSYDLS6	525	NSYDPLM32G	525	NSYDS3D85R	518
NSYDLS8	525	NSYDPLM32TG	525	NSYDS3D86	518, 526
NSYDLSDF10	525	NSYDPLM350	29, 208, 392	NSYDS3D86L	518
NSYDLSDF12	525	NSYDPLM43G	525	NSYDS3D86R	518
NSYDLSDF16	525	NSYDPLM43TG	525	NSYDS3D88	518
NSYDLSDF8	525	NSYDPLM44TG	525	NSYDS3HD106	527
NSYDPA3	127, 298	NSYDPLM54G	525	NSYDS3HD108	527
NSYDPA4	13, 51, 127, 298	NSYDPLM54TG	525	NSYDS3HD32	527
NSYDPA44	13, 51, 127, 298	NSYDPLM64G	525	NSYDS3HD43	527
NSYDPA5	127, 298	NSYDPLM64TG	525	NSYDS3HD54	527
NSYDPHD105P	526	NSYDPLM75G	525	NSYDS3HD64	527
NSYDPHD105R	526	NSYDPLM75TG	525	NSYDS3HD66	527
NSYDPHD107P	526	NSYDPLM86G	525	NSYDS3HD75	527
NSYDPHD107R	526	NSYDPLM86TG	525	NSYDS3HD86	527
NSYDPHD125LP	526	NSYDPR100	263	NSYDS3HD88	527
NSYDPHD125LR	526	NSYDPR120	263	NSYDS3X1010L	523
NSYDPHD125P	526	NSYDPR200	264	NSYDS3X1010LH	523
NSYDPHD125R	526	NSYDPR200D	264	NSYDS3X1010R	523
NSYDPHD127P	526	NSYDPR200T	264	NSYDS3X1010RH	523
NSYDPHD127R	526	NSYDPR25	263	NSYDS3X108	523
NSYDPHD155LP	526	NSYDPR35	263	NSYDS3X108H	523
NSYDPHD155LR	526	NSYDPR45	263	NSYDS3X108T	523
NSYDPHD157P	526	NSYDPR55	263	NSYDS3X1210L	523
NSYDPHD157R	526	NSYDPR60	263	NSYDS3X1210LH	523
NSYDPHD55P	526	NSYDPR65	263	NSYDS3X1210R	523
NSYDPHD55R	526	NSYDPR75	263	NSYDS3X1210RH	523
NSYDPHD75P	526	NSYDPR80	263	NSYDS3X128	523
NSYDPHD75R	526	NSYDS3D1010	518	NSYDS3X128H	523
NSYDPHD77P	526	NSYDS3D105L	518	NSYDS3X32	523
NSYDPHD77R	526	NSYDS3D105R	518	NSYDS3X325	523
NSYDPLA105G	524	NSYDS3D106	518		

Index of references

N	Page	N	Page	N	Page
NSYDS3X325H	523	NSYDT40	181, 287	NSYEC66	22, 102, 117, 364
NSYDS3X32H	523	NSYDTEF32T	501	NSYEC661	22, 102, 118, 364
NSYDS3X33	523	NSYE1025	268	NSYEC662	22, 102, 118, 365
NSYDS3X33H	523	NSYE1525	268	NSYEC68	22, 102, 117, 364
NSYDS3X43	523	NSYE2025	268	NSYEC681	22, 102, 118, 364
NSYDS3X43H	523	NSYEB1510D6	143, 303, 384	NSYEC682	22, 102, 118, 365
NSYDS3X43T	523	NSYEB1516D8	303, 384	NSYEC7	178, 180, 286
NSYDS3X44	523	NSYEB156D6	143, 303, 384	NSYEC810	364
NSYDS3X44H	523	NSYEB2025D8	303, 384	NSYEC8101	364
NSYDS3X46	523	NSYEB2050D8	303, 384	NSYEC8102	365
NSYDS3X46H	523	NSYEBMPLAG	226	NSYEC84	22, 102, 117
NSYDS3X54	523	NSYEC104	22, 102, 117	NSYEC841	22, 102, 118
NSYDS3X54H	523	NSYEC1041	22, 102, 118	NSYEC85	22, 102, 117
NSYDS3X54T	523	NSYEC105	22, 102, 117	NSYEC851	22, 102, 118
NSYDS3X64	523	NSYEC1051	22, 102, 118	NSYEC86	22, 102, 117, 364
NSYDS3X64H	523	NSYEC106	22, 102, 117	NSYEC861	22, 102, 118, 364
NSYDS3X64T	523	NSYEC1061	22, 102, 118	NSYEC862	22, 102, 118, 365
NSYDS3X66	523	NSYEC1062	22, 102, 118	NSYEC88	22, 102, 117, 364
NSYDS3X66H	523	NSYEC108	22, 102, 117	NSYEC881	22, 102, 118, 364
NSYDS3X75	523	NSYEC1081	22, 102, 118	NSYEC882	22, 102, 118, 365
NSYDS3X75H	523	NSYEC1082	22, 102, 118	NSYECA22	267, 312
NSYDS3X75T	523	NSYEC124	22, 102, 117	NSYECA42	267, 312
NSYDS3X86	523	NSYEC1241	22, 102, 118	NSYECA44	267, 312
NSYDS3X86H	523	NSYEC125	22, 102, 117	NSYECAV440	367
NSYDS3X86T	523	NSYEC1251	22, 102, 118	NSYECB1M153	13, 51, 143, 303
NSYDS3X88	523	NSYEC126	22, 102, 117	NSYECPC440	367
NSYDS3X88H	523	NSYEC1261	22, 102, 118	NSYECPC15	178, 179, 285
NSYDSFX1410L	523	NSYEC1262	22, 102, 118	NSYECPC3	178, 179, 285
NSYDSFX1410R	523	NSYEC128	22, 102, 117	NSYECPC5	178, 179, 285
NSYDSFX168	523	NSYEC1281	22, 102, 118	NSYECPC6	178, 179, 285
NSYDSFX1812L	523, 524	NSYEC1282	22, 102, 118	NSYECPC9	178, 179, 285
NSYDSFX1812LH	523	NSYEC164	22, 102, 117	NSYECPLAZ103G	33, 219
NSYDSFX1812R	523, 524	NSYEC1641	22, 102, 118	NSYECPLAZ104G	33, 219
NSYDSFX1812RH	523	NSYEC165	22, 102, 117	NSYECPLAZ123G	33, 219
NSYDSFX1816L	523	NSYEC1651	22, 102, 118	NSYECPLAZ124G	33, 219
NSYDSFX1816LH	523	NSYEC166	22, 102, 117	NSYECPLAZ126G	33, 219
NSYDSFX1816R	523	NSYEC1661	22, 102, 118	NSYECPLAZ53G	33, 219
NSYDSFX1816RH	523	NSYEC1662	22, 102, 118	NSYECPLAZ54G	33, 219
NSYDSFX186	523, 524	NSYEC35	22, 102, 117	NSYECPLAZ73G	33, 219
NSYDSFX188	523, 524	NSYEC351	22, 102, 118	NSYECPLAZ74G	33, 219
NSYDSFX188H	523	NSYEC36	22, 102, 117	NSYECPLAZ76G	33, 219
NSYDSFX2010L	523, 524	NSYEC361	22, 102, 118	NSYECVT2440	367
NSYDSFX2010LH	523	NSYEC381	22, 102	NSYECVT2V440	367
NSYDSFX2010R	523, 524	NSYEC44	22, 102, 117	NSYECVT3440	367
NSYDSFX2010RH	523	NSYEC440	367	NSYECVT3V440	367
NSYDSFX2012L	523, 524	NSYEC441	22, 102, 118	NSYEDCO	252
NSYDSFX2012LH	523	NSYEC45	22, 102, 117	NSYEDCOC	13, 51, 252
NSYDSFX2012R	523, 524	NSYEC451	22, 102, 118	NSYEDCOS	13, 15, 51, 59, 303
NSYDSFX2012RH	523	NSYEC461	22, 102, 118	NSYEDPLA	230
NSYDSFX2016L	523, 524	NSYEC462	22, 102, 118	NSYEL136D6	143, 303
NSYDSFX2016LH	523	NSYEC481	22, 102, 118	NSYEL166D6	143, 303
NSYDSFX2016R	523, 524	NSYEC482	22, 102, 118	NSYEL166D8	13, 14, 51, 58, 143, 303
NSYDSFX2016RH	523	NSYEC610	364	NSYEL1710D6	143, 303
NSYDSFX206	523, 524	NSYEC6101	364	NSYEL2225D8	143, 303
NSYDSFX208	523, 524	NSYEC6102	365	NSYEL226D13	143, 303, 410, 411
NSYDT16	181, 287	NSYEC64	22, 102, 117	NSYEL226D6	143, 303
NSYDT20	181, 287	NSYEC641	22, 102, 118	NSYEL2510D6	143, 303
NSYDT25	181, 287	NSYEC65	22, 102, 117	NSYEL3525D8	13, 51, 143, 303
NSYDT32	181, 287	NSYEC651	22, 102, 118	NSYEMA20	266, 311

Index of references

N	Page	N	Page	N	Page
NSYEMA40	266, 311	NSYGB140	373	NSYINLCRN	12, 14, 50, 58, 298, 351, 354
NSYEN20	267	NSYGDD	518	NSYINPULS1	129
NSYEN40	267	NSYGFR12M65	269	NSYINS61	130, 225, 414
NSYEN60	267	NSYGFR166P	269, 374	NSYINS71	130, 225, 414
NSYETF	252	NSYGFR95M55	269, 374	NSYINS81	130, 225, 414
NSYETU118	268, 313	NSYGFR95M63	269, 374	NSYINS8G1	130, 414
NSYETU48	268, 313	NSYGFR95M65	269, 374	NSYINT101	130, 414
NSYETU58	268, 313	NSYHLCR40	257, 261, 344	NSYINT61	130, 225, 414
NSYETU79	268, 313	NSYHLCR50	257, 261	NSYINT71	130, 414
NSYEVA20	266, 311	NSYHLCR60	257, 261, 344	NSYINT81	130, 225, 414
NSYEVA40	266, 311	NSYHLCR70	257, 261	NSYINT91	130, 414
NSYEX1006	268	NSYHLCR80	257, 261, 344	NSYKPLM	86, 207
NSYEX1008	268	NSYHS3X	523	NSYLADP	131
NSYEX106	268	NSYHSD	525	NSYLAM1M	294
NSYEX126	268	NSYHSDF	525	NSYLAM1MN	294
NSYEX146	268	NSYHSMX	524	NSYLAM1U	294
NSYEX158	268	NSYID166	21, 101, 125	NSYLAM3M	294
NSYEX166	268	NSYID168	21, 101, 125	NSYLAM3MDC	294
NSYEX186	268	NSYID1810	21, 101, 125	NSYLAM3MDCUL	294
NSYEX206	268, 366	NSYID186	21, 101, 125	NSYLAM3MN	294
NSYEX208	268	NSYID188	21, 101, 125	NSYLAM75	12, 50
NSYEX306	268	NSYID2010	21, 101, 125	NSYLAMACF	295
NSYEX308	268	NSYID206	21, 101, 125	NSYLAMACM	295
NSYEX406	268	NSYID208	21, 101, 125	NSYLAMDCF	295
NSYEX408	268	NSYID226	125	NSYLAMDCCM	295
NSYEX506	268	NSYID228	125	NSYLAMLDD	294
NSYEX508	268	NSYIN1242E1	130, 225, 414	NSYLAMLDB	294
NSYEX608	268	NSYIN1242E2	131, 225	NSYLAMLDD	294
NSYFB	244	NSYIN1332E1	130, 225, 414	NSYLAMLDF	294
NSYFB45	252	NSYIN2124E1	130, 225, 414	NSYLAMLDS	294
NSYFCG100	288	NSYIN2131A1	130, 225, 414	NSYLAMLVDC	294
NSYFCG120	288	NSYIN2132A1	130, 225, 414	NSYLAMPORLTD	296
NSYFCG160	288	NSYIN2331A1	130, 225, 414	NSYLAMT5LD1	296
NSYFCG60	288	NSYIN2433A1	130, 225, 414	NSYLAMT5LD1VDC	296
NSYFCG80	288	NSYIN2452E1	130, 225, 414	NSYLAMT5LD2	296
NSYFCMX	165	NSYIN3113A1	130, 225, 414	NSYLC7	86, 87, 226
NSYFDLSD	525	NSYIN3122E1	130, 225, 414	NSYLC8	86, 87, 226
NSYFECVT440	367	NSYIN3123A1	130, 225, 414	NSYLCK12SF	521, 522
NSYFMPHD	327	NSYIN3131A1	130, 225, 414	NSYLCK14SF	521, 522
NSYFMPLA	219	NSYIN3133A1	130, 225, 414	NSYLCK16SF	521, 522
NSYFNM6	251, 271	NSYIN3422E1	130, 225, 414	NSYLCK18SF	521, 522
NSYFNM8	251, 271	NSYIN3432E1	130, 225, 414	NSYLCK20SF	521, 522
NSYFPLS1827G	184	NSYIN405E1	130, 225, 414	NSYLCK22SF	521, 522
NSYFPLS2727G	184	NSYIN421E1	130, 225, 414	NSYLCKWSF	521, 522
NSYFPLS2736G	184	NSYIN4551	130, 225, 414	NSYLCR40	257
NSYFPLS2754G	184	NSYIN6101	130, 225, 414	NSYLCR50	257
NSYFPLS3636G	184	NSYINASSA2	131	NSYLCR60	257
NSYFPLS3654G	184	NSYINDB31	130, 414	NSYLD5	86, 87, 226
NSYFPLS3672G	184	NSYINDB51	130, 225, 414	NSYLSS3X10	523
NSYFPLS5454G	184	NSYINDIN2	131, 225	NSYLSS3X12	523
NSYFPLS5472G	184	NSYINE11	130, 414	NSYLSSDX	525
NSYFSPLAZ	223	NSYINF1301	130, 414	NSYLSSF14	523, 524
NSYFXT6040	259	NSYINF1401	130, 414	NSYLSSF16	523, 524
NSYFXT6050	259	NSYINICHEL8131	130, 414	NSYLSSF18	523, 524
NSYFXT6060	259, 420	NSYINICHEL8371	130, 414	NSYLSSF20	523, 524
NSYFXT8040	259	NSYINKBA2	131	NSYLSUP	257
NSYFXT8050	259	NSYINKFAC2	131, 225	NSYLT27	188
NSYFXT8060	259	NSYINKJIS2	131, 225	NSYLT8	86, 87, 226
NSYFXT8080	259	NSYINKR2	131, 225	NSYMB106	17, 77, 241

Index of references

N	Page
NSYMB108	17, 29, 77, 205, 241
NSYMB1210	17, 77, 241
NSYMB3025	17, 29, 77, 205, 241
NSYMB32	17, 29, 77, 205, 241
NSYMB33	17, 77, 241
NSYMB43	17, 29, 77, 205, 241
NSYMB54	17, 29, 77, 205, 241
NSYMB64	17, 29, 77, 205, 241
NSYMB65	17, 77, 241
NSYMB75	17, 29, 77, 205, 241
NSYMB86	17, 29, 77, 205, 241
NSYMBR19	370
NSYMCOD264	127
NSYMCOD284	127
NSYMD108	17, 77, 241, 392
NSYMD128	17, 77, 241
NSYMD33	17, 77, 241, 392
NSYMD43	17, 77, 241, 392
NSYMD54	17, 77, 241, 392
NSYMD64	17, 77, 241, 392
NSYMD66	17, 77, 241, 392
NSYMD75	17, 77, 241, 392
NSYMD86	17, 77, 241, 392
NSYMDCM20	128, 298
NSYMDVR10	13, 15, 17, 19, 51, 59, 77, 244
NSYMDVR12	13, 15, 17, 51, 59, 77, 244
NSYMDVR3	13, 15, 17, 19, 51, 59, 77, 244
NSYMDVR3M	244
NSYMDVR4	13, 15, 17, 19, 51, 59, 77, 244
NSYMDVR5	13, 15, 17, 19, 51, 59, 77, 244
NSYMDVR6	13, 15, 17, 19, 51, 59, 77, 244
NSYMDVR7	13, 15, 17, 19, 51, 59, 77, 244
NSYMDVR8	13, 15, 17, 19, 51, 59, 77, 244
NSYMF1010	13, 15, 16, 26, 51, 59, 76, 152, 240
NSYMF106	13, 15, 16, 26, 51, 59, 76, 152, 240
NSYMF108	13, 15, 16, 26, 29, 51, 59, 76, 152, 204, 240, 391
NSYMF1210	13, 15, 16, 26, 51, 59, 76, 152, 240
NSYMF126	16, 26, 76, 152, 240
NSYMF128	13, 15, 16, 26, 51, 59, 76, 152, 240
NSYMF2PLAZ4	325, 327
NSYMF2PLAZ6	325, 327
NSYMF32	13, 15, 16, 26, 51, 59, 76, 152, 240
NSYMF33	13, 15, 16, 26, 51, 59, 76, 152, 240, 391
NSYMF43	13, 15, 16, 26, 29, 51, 59, 76, 152, 204, 240, 391
NSYMF44	13, 15, 16, 26, 51, 59, 76, 152, 240, 391, 408
NSYMF53	240
NSYMF54	13, 15, 16, 26, 29, 51, 59, 76, 152, 204, 240, 391
NSYMF55	13, 15, 16, 51, 59, 76, 240

N	Page
NSYMF64	13, 15, 16, 26, 29, 51, 59, 76, 152, 204, 240, 391, 408
NSYMF65	16, 76, 240
NSYMF66	13, 15, 16, 26, 51, 59, 76, 152, 240, 391
NSYMF75	13, 15, 16, 26, 29, 51, 59, 76, 152, 204, 240, 391
NSYMF86	13, 15, 16, 26, 29, 51, 59, 76, 152, 204, 240, 391
NSYMF88	13, 15, 16, 26, 51, 59, 76, 152, 240
NSYMF8	251, 270
NSYMF2M6	126
NSYMF2M8	126
NSYMF5M6	126
NSYMF5M8	126
NSYMFPLAZ103	33, 223
NSYMFPLAZ104	33, 223
NSYMFPLAZ123	33, 223
NSYMFPLAZ124	33, 223
NSYMFPLAZ126	33, 223
NSYMFPLAZ53	33, 223
NSYMFPLAZ54	33, 223
NSYMFPLAZ73	33, 223
NSYMFPLAZ74	33, 223
NSYMFPLAZ76	33, 223
NSYMIC6	127
NSYMIC8	127
NSYML23	421
NSYML405SSD	413
NSYMLCD23	421
NSYMLS6	421
NSYMLT6	421
NSYMM1010	13, 14, 16, 26, 51, 58, 76, 152, 240
NSYMM1010WH	13, 14, 51, 58
NSYMM106	13, 14, 16, 19, 26, 51, 58, 76, 152, 240, 332
NSYMM106WH	13, 14, 51, 58
NSYMM108	13, 14, 16, 19, 26, 29, 51, 58, 76, 152, 204, 240, 332, 339, 391
NSYMM108WH	13, 14, 51, 58
NSYMM11SB	40, 42, 140
NSYMM1210	13, 14, 16, 26, 51, 58, 76, 152, 240
NSYMM1210WH	13, 14, 51, 58
NSYMM1212	16, 76, 240
NSYMM126	16, 26, 76, 152, 240
NSYMM128	13, 14, 16, 26, 51, 58, 76, 152, 240
NSYMM128WH	13, 14, 51, 58
NSYMM12SB	40, 42
NSYMM13SB	40, 42, 140
NSYMM1410	16, 76, 240
NSYMM14SB	40, 42
NSYMM22	16, 76, 240
NSYMM22SB	40, 42, 140
NSYMM23	240
NSYMM23SB	40, 42, 140

N	Page
NSYMM24SB	40, 42, 140
NSYMM2520	16, 76, 240
NSYMM2540	19, 240
NSYMM2550	19, 240
NSYMM25SB	40, 42
NSYMM26SB	40, 42
NSYMM28SB	40, 42
NSYMM3025	16, 19, 26, 29, 76, 152, 204, 240, 391
NSYMM3045	16, 76, 240
NSYMM32	13, 14, 16, 19, 26, 29, 51, 58, 76, 152, 204, 240, 332, 391
NSYMM32WH	13, 14, 51, 58
NSYMM33	13, 14, 16, 19, 26, 51, 58, 76, 152, 240, 391
NSYMM33SB	40, 42, 140
NSYMM33WH	13, 14, 51, 58
NSYMM34SB	40, 42
NSYMM35SB	40, 42
NSYMM36	19, 240
NSYMM36SB	40, 42
NSYMM38SB	40, 42
NSYMM43	13, 14, 16, 19, 26, 29, 51, 58, 76, 152, 204, 240, 391
NSYMM43WH	13, 14, 51, 58
NSYMM44	13, 14, 16, 26, 51, 58, 76, 152, 240, 391, 408
NSYMM44SB	40, 42
NSYMM44WH	13, 14, 51, 58
NSYMM45SB	40, 42
NSYMM46SB	40, 42
NSYMM48	19, 240
NSYMM48SB	40, 42
NSYMM53	19, 240
NSYMM54	13, 14, 16, 19, 26, 29, 51, 58, 76, 152, 204, 240, 332, 391
NSYMM54WH	13, 14, 51, 58
NSYMM55	13, 14, 16, 51, 58, 76, 240
NSYMM55WH	13, 14, 51, 58
NSYMM64	13, 14, 16, 19, 26, 29, 51, 58, 76, 152, 204, 240, 332, 391, 408
NSYMM64WH	13, 14, 51, 58
NSYMM65	16, 19, 76, 240
NSYMM66	13, 14, 16, 19, 26, 51, 58, 76, 152, 240, 332, 391
NSYMM66WH	13, 14, 51, 58
NSYMM75	13, 14, 16, 19, 26, 29, 51, 58, 76, 152, 204, 240, 332, 339, 391
NSYMM75WH	13, 14, 51, 58
NSYMM76	19, 240
NSYMM86	13, 14, 16, 19, 26, 29, 51, 58, 76, 152, 204, 240, 332, 339, 391
NSYMM86WH	13, 14, 51, 58
NSYMM88	13, 14, 16, 26, 51, 58, 76, 152, 240, 332
NSYMM88WH	13, 14, 51, 58
NSYMP1210	21, 101, 245
NSYMP1212	21, 101, 245, 332
NSYMP126	23, 24, 103, 104, 245, 332

Index of references

N	Page	N	Page	N	Page
NSYMP128	21, 23, 24, 101, 103, 104, 245, 332	NSYMPD4M6	126	NSYMR68	16, 76, 240
NSYMP1410	21, 27, 101, 164, 245, 416	NSYMPD4M8	126	NSYMR75	13, 15, 16, 19, 26, 29, 51, 59, 76, 152, 205, 240, 391
NSYMP1412	21, 101, 245, 416	NSYMPD5M6	126	NSYMR76	19, 240
NSYMP146	21, 23, 24, 101, 103, 104, 245	NSYMPD5M8	126	NSYMR810	16, 76, 240
NSYMP148	21, 23, 24, 101, 103, 104, 245, 416	NSYMPD66T	126	NSYMR86	13, 15, 16, 19, 26, 29, 51, 59, 76, 152, 205, 240, 391
NSYMP1610	21, 101, 245	NSYMPD68T	126	NSYMR88	13, 15, 16, 26, 51, 59, 76, 152, 240
NSYMP1612	21, 101, 245, 332	NSYMPD6M6	126	NSYMS43	16, 26, 29, 76, 152, 204, 240, 391
NSYMP166	21, 23, 24, 101, 103, 104, 245, 332	NSYMPD6M8	126	NSYMS44	16, 26, 76, 152, 240, 391
NSYMP168	21, 23, 24, 27, 101, 103, 104, 164, 245, 332	NSYMPD86T	126	NSYMS53	240
NSYMP1810	21, 23, 24, 101, 103, 104, 245	NSYMPD88T	126	NSYMS54	16, 26, 29, 76, 152, 204, 240, 391
NSYMP1812	21, 23, 24, 27, 101, 103, 104, 164, 245	NSYMPD8M6	126	NSYMS55	16, 76, 240
NSYMP1816	21, 27, 101, 164, 245	NSYMPD8M8	126	NSYMS564	16, 26, 29, 76, 152, 204, 240, 391
NSYMP184	23, 24, 103, 104, 245	NSYMPD9M6	126	NSYMS66	16, 26, 76, 152, 240, 391
NSYMP186	21, 23, 24, 27, 101, 103, 104, 164, 245	NSYMPD9M8	126	NSYMS75	16, 26, 29, 76, 152, 204, 240, 391
NSYMP188	21, 23, 24, 27, 101, 103, 104, 164, 245	NSYMPD9M8	126	NSYMS86	16, 26, 29, 76, 152, 204, 240, 391
NSYMP2010	21, 23, 25, 27, 101, 103, 105, 164, 245	NSYMP108	29, 205, 241, 339	NSYMUPLA103G	218
NSYMP2012	21, 23, 25, 27, 101, 103, 105, 164, 245	NSYMP3025	29, 205, 241	NSYMUPLA103W	218
NSYMP2016	21, 23, 25, 27, 101, 103, 105, 164, 245	NSYMP32	29, 205, 241	NSYMUPLA104G	218
NSYMP204	23, 25, 103, 105, 245	NSYMP43	29, 205, 241	NSYMUPLA104W	218
NSYMP206	21, 23, 25, 27, 101, 103, 105, 164, 245, 343	NSYMP54	29, 205, 241	NSYMUPLA123G	218
NSYMP208	21, 23, 25, 27, 101, 103, 105, 164, 245, 332, 343	NSYMP64	29, 205, 241	NSYMUPLA123W	218
NSYMP2210	23, 25, 103, 105, 245	NSYMP75	29, 205, 241, 339	NSYMUPLA124G	218
NSYMP2212	23, 25, 103, 105, 245	NSYMP86	29, 205, 241, 339	NSYMUPLA124W	218
NSYMP224	23, 25, 103, 105, 245	NSYMPR10	247	NSYMUPLA126G	218
NSYMP226	23, 25, 103, 105, 245	NSYMPR12	247	NSYMUPLA126W	218
NSYMP228	23, 25, 103, 105, 245	NSYMPR16	247	NSYMUPLA153G	218
NSYMPB4SD	416	NSYMPR8	247	NSYMUPLA153W	218
NSYMPB6SD	416	NSYMR1010	13, 15, 16, 26, 51, 59, 76, 152, 240	NSYMUPLA154G	218
NSYMPBSD	416	NSYMR1012	16, 76, 240	NSYMUPLA154W	218
NSYMPD106T	126	NSYMR106	13, 15, 16, 19, 26, 51, 59, 76, 152, 240	NSYMUPLA156G	218
NSYMPD108T	126	NSYMR108	13, 15, 16, 19, 26, 29, 51, 59, 76, 152, 205, 240, 391	NSYMUPLA156W	218
NSYMPD12M6	126	NSYMR1210	13, 15, 16, 26, 51, 59, 76, 152, 240	NSYMUPLA204G	218
NSYMPD12M8	126	NSYMR126	16, 76, 240	NSYMUPLA204W	218
NSYMPD16M6	126	NSYMR128	13, 15, 16, 26, 51, 59, 76, 152, 240	NSYMUPLA53G	218
NSYMPD16M8	126	NSYMR1410	16, 76, 240	NSYMUPLA53W	218
NSYMPD18M6	126	NSYMR3025	16, 26, 29, 76, 152, 205, 240, 391	NSYMUPLA54G	218
NSYMPD18M8	126	NSYMR32	13, 15, 26, 29, 51, 59, 152, 205, 240, 391	NSYMUPLA54W	218
NSYMPD20M6	126	NSYMR33	13, 15, 16, 19, 26, 51, 59, 76, 152, 240, 391	NSYMUPLA73G	218
NSYMPD20M8	126	NSYMR34	16, 19, 76, 240	NSYMUPLA73W	218
NSYMPD24M6	126	NSYMR43	13, 15, 16, 19, 26, 29, 51, 59, 76, 152, 205, 240, 391	NSYMUPLA74G	218
NSYMPD24M8	126	NSYMR44	13, 15, 16, 26, 51, 59, 76, 152, 240, 408	NSYMUPLA74W	218
NSYMPD26T	126	NSYMR46	16, 19, 26, 76, 152, 240	NSYMUPLA76G	218
NSYMPD28T	126	NSYMR53	240	NSYMUPLA76W	218
NSYMPD3M6	126	NSYMR54	13, 15, 16, 19, 26, 29, 51, 59, 76, 152, 205, 240, 391	NSYMW10M	301
NSYMPD3M8	126	NSYMR55	13, 15, 16, 51, 59, 76, 240	NSYMW10MK	301
NSYMPD46T	126	NSYMR64	13, 15, 16, 19, 26, 29, 51, 59, 76, 152, 205, 240, 391, 408	NSYMW10MR	301
NSYMPD48T	126	NSYMR65	16, 76, 240	NSYNM4	244, 271
		NSYMR66	13, 15, 16, 19, 26, 51, 59, 76, 152, 240, 391	NSYNM5	244, 271
				NSYNM6	12, 50, 244, 271
				NSYOL6GF	114
				NSYPA3025PLMG	29, 203
				NSYPAP108G	29, 203
				NSYPAP43G	29, 203
				NSYPAP54G	29, 203
				NSYPAP64G	29, 203
				NSYPAP75G	29, 203

Index of references

N	Page	N	Page	N	Page
NSYPAP86G	29, 203	NSYPHDZT1574P	326, 334, 452	NSYPLA1276TG	30, 216
NSYPAPLA105G	32, 224	NSYPHDZT1576	326, 334, 452	NSYPLA15103G	30, 216
NSYPAPLA107G	32, 224	NSYPHDZT1576P	326, 334, 452	NSYPLA15103TG	30, 216
NSYPAPLA125G	32, 224	NSYPHDZT2074	326, 334, 452	NSYPLA15104G	30, 216
NSYPAPLA127G	32, 224	NSYPHDZT2074P	326, 334, 452	NSYPLA15104TG	30, 216
NSYPAPLA155G	32, 224	NSYPHDZT774	326, 334, 452	NSYPLA15123G	30, 216
NSYPAPLA157G	32, 224	NSYPHDZT774P	326, 334, 452	NSYPLA15123TG	30, 216
NSYPAPLA55G	32, 224	NSYPHDZT776	326, 334, 452	NSYPLA15124G	30, 216
NSYPAPLA57G	32, 224	NSYPHDZT776P	326, 334, 452	NSYPLA15124TG	30, 216
NSYPAPLA75G	32, 224	NSYPHLT6040	261	NSYPLA15126G	30, 216
NSYPAPLA77G	32, 224	NSYPHLT6060	261	NSYPLA15126TG	30, 216
NSYPC100	521, 522	NSYPHLT6080	261	NSYPLA1553G	30, 216
NSYPC200	521, 522	NSYPHLT8040	261	NSYPLA1553TG	30, 216
NSYPCVD126	362	NSYPHLT8080	261	NSYPLA1554G	30, 216
NSYPCVD128	362	NSYPHX200	165, 297	NSYPLA1554TG	30, 216
NSYPCVD148	362	NSYPIN106	15, 59, 69, 79, 90	NSYPLA1573G	30, 216
NSYPCVD168	362	NSYPIN108	15, 59, 69, 79, 90, 156	NSYPLA1573TG	30, 216
NSYPCVD188	362	NSYPIN126	79, 90	NSYPLA1574G	30, 216
NSYPCVD206	362	NSYPIN128	15, 59, 69, 79, 90, 156	NSYPLA1574TG	30, 216
NSYPCVD208	362	NSYPIN43	15, 59, 69, 79, 90, 156	NSYPLA1576G	30, 216
NSYPCVD226	362	NSYPIN54	15, 59, 69, 79, 90, 156	NSYPLA1576TG	30, 216
NSYPCVD228	362	NSYPIN64	15, 59, 69, 79, 90, 156	NSYPLA2074G	30, 216
NSYPCVR124HD	328, 334, 335, 452, 453	NSYPIN75	15, 59, 69, 79, 90, 156	NSYPLA2074TG	30, 216
NSYPCVR126HD	328, 334, 335, 452, 453	NSYPIN86	15, 59, 69, 79, 90, 156	NSYPLA5103G	30, 216
NSYPCVR54HD	328, 334, 335, 452, 453	NSYPLA10103G	30, 216	NSYPLA5103TG	30, 216
NSYPCVR74HD	328, 334, 335, 452, 453	NSYPLA10103TG	30, 216	NSYPLA5104G	30, 216
NSYPCVR76HD	328, 334, 335, 452, 453	NSYPLA10104G	30, 216	NSYPLA5104TG	30, 216
NSYPF27N	186	NSYPLA10104TG	30, 216	NSYPLA5123G	30, 216
NSYPF27X	186	NSYPLA10123G	30, 216	NSYPLA5123TG	30, 216
NSYRFC2X	80, 154	NSYPLA10123TG	30, 216	NSYPLA5124G	30, 216
NSYRFCR	79, 80	NSYPLA10124G	30, 216	NSYPLA5124TG	30, 216
NSYRFCX	12, 50, 154	NSYPLA10124TG	30, 216	NSYPLA553G	30, 216
NSYFPLM	12, 50	NSYPLA1053G	30, 216	NSYPLA553TG	30, 216
NSYFPLM32G	29, 202	NSYPLA1053TG	30, 216	NSYPLA554G	30, 216
NSYFPLMG	29, 202, 339	NSYPLA1054G	30, 216	NSYPLA554TG	30, 216
NSYFPLM	202, 339	NSYPLA1054TG	30, 216	NSYPLA573G	30, 216
NSYPHDT553	326, 334, 452	NSYPLA1073G	30, 216	NSYPLA573TG	30, 216
NSYPHDT553P	326, 334, 452	NSYPLA1073TG	30, 216	NSYPLA574G	30, 216
NSYPHDT753	326, 334, 452	NSYPLA1074G	30, 216	NSYPLA574TG	30, 216
NSYPHDT753P	326, 334, 452	NSYPLA1074TG	30, 216	NSYPLA7103G	30, 216
NSYPHDZT1054	326, 334, 452	NSYPLA12103G	30, 216	NSYPLA7103TG	30, 216
NSYPHDZT1054P	326, 334, 452	NSYPLA12103TG	30, 216	NSYPLA7104G	30, 216
NSYPHDZT1074	326, 334, 452	NSYPLA12104G	30, 216	NSYPLA7104TG	30, 216
NSYPHDZT1074P	326, 334, 452	NSYPLA12104TG	30, 216	NSYPLA7123G	30, 216
NSYPHDZT12124	326, 334, 452	NSYPLA12123G	30, 216	NSYPLA7123TG	30, 216
NSYPHDZT12124P	326, 334, 452	NSYPLA12123TG	30, 216	NSYPLA7124G	30, 216
NSYPHDZT12126	326, 334, 452	NSYPLA12124G	30, 216	NSYPLA7124TG	30, 216
NSYPHDZT12126P	326, 334, 452	NSYPLA12124TG	30, 216	NSYPLA753G	30, 216
NSYPHDZT1254	326, 334, 452	NSYPLA12126G	30, 216	NSYPLA753TG	30, 216
NSYPHDZT1254P	326, 334, 452	NSYPLA12126TG	30, 216	NSYPLA754G	30, 216
NSYPHDZT1274	326, 334, 452	NSYPLA1253G	30, 216	NSYPLA754TG	30, 216
NSYPHDZT1274P	326, 334, 452	NSYPLA1253TG	30, 216	NSYPLA773G	30, 216
NSYPHDZT1276	326, 334, 452	NSYPLA1254G	30, 216	NSYPLA773TG	30, 216
NSYPHDZT1276P	326, 334, 452	NSYPLA1254TG	30, 216	NSYPLA774G	30, 216
NSYPHDZT15124	326, 334, 452	NSYPLA1273G	30, 216	NSYPLA774TG	30, 216
NSYPHDZT15124P	326, 334, 452	NSYPLA1273TG	30, 216	NSYPLA776G	30, 216
NSYPHDZT15126	326, 334, 452	NSYPLA1274G	30, 216	NSYPLA776TG	30, 216
NSYPHDZT15126P	326, 334, 452	NSYPLA1274TG	30, 216	NSYPLAT10103G	31, 217
NSYPHDZT1574	326, 334, 452	NSYPLA1276G	30, 216	NSYPLAT10104G	31, 217

Index of references

N	Page	N	Page	N	Page
NSYPLAT10123G	31, 217	NSYPLAZ1273G	30, 216	NSYPLAZT2074G	31, 217
NSYPLAT10124G	31, 217	NSYPLAZ1274G	30, 216	NSYPLAZT5103G	31, 217
NSYPLAT1053G	31, 217	NSYPLAZ1276G	30, 216	NSYPLAZT5104G	31, 217
NSYPLAT1054G	31, 217	NSYPLAZ15103G	30, 216	NSYPLAZT5123G	31, 217
NSYPLAT1073G	31, 217	NSYPLAZ15104G	30, 216	NSYPLAZT5124G	31, 217
NSYPLAT1074G	31, 217	NSYPLAZ15123G	30, 216	NSYPLAZT553G	31, 217
NSYPLAT12103G	31, 217	NSYPLAZ15124G	30, 216	NSYPLAZT554G	31, 217
NSYPLAT12104G	31, 217	NSYPLAZ15126G	30, 216	NSYPLAZT573G	31, 217
NSYPLAT12123G	31, 217	NSYPLAZ1553G	30, 216	NSYPLAZT574G	31, 217
NSYPLAT12124G	31, 217	NSYPLAZ1554G	30, 216	NSYPLAZT7103G	31, 217
NSYPLAT12126G	31, 217	NSYPLAZ1573G	30, 216	NSYPLAZT7104G	31, 217
NSYPLAT1253G	31, 217	NSYPLAZ1574G	30, 216	NSYPLAZT7123G	31, 217
NSYPLAT1254G	31, 217	NSYPLAZ1576G	30, 216	NSYPLAZT7124G	31, 217
NSYPLAT1273G	31, 217	NSYPLAZ2074G	30, 216	NSYPLAZT753G	31, 217
NSYPLAT1274G	31, 217	NSYPLAZ5103G	30, 216	NSYPLAZT754G	31, 217
NSYPLAT1276G	31, 217	NSYPLAZ5104G	30, 216	NSYPLAZT773G	31, 217
NSYPLAT15103G	31, 217	NSYPLAZ5123G	30, 216	NSYPLAZT774G	31, 217
NSYPLAT15104G	31, 217	NSYPLAZ5124G	30, 216	NSYPLAZT776G	31, 217
NSYPLAT15123G	31, 217	NSYPLAZ553G	30, 216	NSYPLHD	327
NSYPLAT15124G	31, 217	NSYPLAZ554G	30, 216	NSYPLM108	13, 51, 204
NSYPLAT15126G	31, 217	NSYPLAZ573G	30, 216	NSYPLM108BG	200
NSYPLAT1553G	31, 217	NSYPLAZ574G	30, 216	NSYPLM108G	28, 199, 200, 201, 211
NSYPLAT1554G	31, 217	NSYPLAZ7103G	30, 216	NSYPLM108TG	28, 199, 200, 211
NSYPLAT1573G	31, 217	NSYPLAZ7104G	30, 216	NSYPLM3025	204
NSYPLAT1574G	31, 217	NSYPLAZ7123G	30, 216	NSYPLM3025BG	200
NSYPLAT1576G	31, 217	NSYPLAZ7124G	30, 216	NSYPLM3025G	28, 199, 200
NSYPLAT2074G	31, 217	NSYPLAZ753G	30, 216	NSYPLM3025PG	200
NSYPLAT5103G	31, 217	NSYPLAZ754G	30, 216	NSYPLM3025TG	28, 199, 200
NSYPLAT5104G	31, 217	NSYPLAZ773G	30, 216	NSYPLM32	13, 51, 204
NSYPLAT5123G	31, 217	NSYPLAZ774G	30, 216	NSYPLM32BG	200
NSYPLAT5124G	31, 217	NSYPLAZ776G	30, 216	NSYPLM32G	28, 199, 200
NSYPLAT553G	31, 217	NSYPLAZT10103G	31, 217	NSYPLM32PG	200
NSYPLAT554G	31, 217	NSYPLAZT10104G	31, 217	NSYPLM32TG	28, 199, 200
NSYPLAT573G	31, 217	NSYPLAZT10123G	31, 217	NSYPLM43	13, 51, 204
NSYPLAT574G	31, 217	NSYPLAZT10124G	31, 217	NSYPLM43BG	200
NSYPLAT7103G	31, 217	NSYPLAZT1053G	31, 217	NSYPLM43G	28, 199, 200, 211
NSYPLAT7104G	31, 217	NSYPLAZT1054G	31, 217	NSYPLM43PG	200
NSYPLAT7123G	31, 217	NSYPLAZT1073G	31, 217	NSYPLM43TG	28, 199, 200, 211
NSYPLAT7124G	31, 217	NSYPLAZT1074G	31, 217	NSYPLM43TVG	28, 199, 200, 211
NSYPLAT753G	31, 217	NSYPLAZT12103G	31, 217	NSYPLM43VG	28, 199, 200
NSYPLAT754G	31, 217	NSYPLAZT12104G	31, 217	NSYPLM54	13, 51, 204
NSYPLAT773G	31, 217	NSYPLAZT12123G	31, 217	NSYPLM54BG	200
NSYPLAT774G	31, 217	NSYPLAZT12124G	31, 217	NSYPLM54G	28, 199, 200, 211
NSYPLAT776G	31, 217	NSYPLAZT12126G	31, 217	NSYPLM54PG	200
NSYPLAZ10103G	30, 216	NSYPLAZT1253G	31, 217	NSYPLM54TG	28, 199, 200, 211
NSYPLAZ10104G	30, 216	NSYPLAZT1254G	31, 217	NSYPLM54TVG	28, 199, 200, 211
NSYPLAZ10123G	30, 216	NSYPLAZT1273G	31, 217	NSYPLM54VG	28, 199, 200
NSYPLAZ10124G	30, 216	NSYPLAZT1274G	31, 217	NSYPLM57G	339
NSYPLAZ1053G	30, 216	NSYPLAZT1276G	31, 217	NSYPLM64	13, 51, 204
NSYPLAZ1054G	30, 216	NSYPLAZT15103G	31, 217	NSYPLM64BG	200
NSYPLAZ1073G	30, 216	NSYPLAZT15104G	31, 217	NSYPLM64G	28, 199, 200, 211
NSYPLAZ1074G	30, 216	NSYPLAZT15123G	31, 217	NSYPLM64PG	200
NSYPLAZ12103G	30, 216	NSYPLAZT15124G	31, 217	NSYPLM64TG	28, 199, 200, 211
NSYPLAZ12104G	30, 216	NSYPLAZT15126G	31, 217	NSYPLM64TVG	28, 199, 200, 211
NSYPLAZ12123G	30, 216	NSYPLAZT1553G	31, 217	NSYPLM64VG	28, 199, 200
NSYPLAZ12124G	30, 216	NSYPLAZT1554G	31, 217	NSYPLM68G	339
NSYPLAZ12126G	30, 216	NSYPLAZT1573G	31, 217	NSYPLM75	204
NSYPLAZ1253G	30, 216	NSYPLAZT1574G	31, 217	NSYPLM75BG	200
NSYPLAZ1254G	30, 216	NSYPLAZT1576G	31, 217	NSYPLM75G	28, 199, 200, 201, 211

Index of references

N	Page	N	Page	N	Page
NSYPLM75PG	200	NSYPMA2736G	185	NSYPMM3636	185
NSYPLM75TG	28, 199, 200, 211	NSYPMA2754G	185	NSYPMM3654	185
NSYPLM75TVG	28, 199, 200, 211	NSYPMA3636G	185	NSYPMM3672	185
NSYPLM75VG	28, 199, 200	NSYPMA3654G	185	NSYPMM510	32, 228
NSYPLM810G	339	NSYPMA3672G	185	NSYPMM5454	185
NSYPLM86	13, 51, 204	NSYPMA510	32, 228	NSYPMM5472	185
NSYPLM86BG	200	NSYPMA5454G	185	NSYPMM55	32, 228, 328
NSYPLM86G	28, 199, 200, 201, 211	NSYPMA5472G	185	NSYPMM710	32, 228
NSYPLM86PG	200	NSYPMA55	32, 228	NSYPMM712	32, 228
NSYPLM86TG	28, 199, 200, 211	NSYPMA710	32, 228	NSYPMM75	32, 228, 328
NSYPLM86TVG	28, 199, 200, 211	NSYPMA712	32, 228	NSYPMM77	32, 228, 328
NSYPLM86VG	28, 199, 200	NSYPMA75	32, 228	NSYPMP45100	415
NSYPLS1827G	11, 183, 184	NSYPMA77	32, 228	NSYPMP45120	415
NSYPLS24	412	NSYPMB1010	32, 228	NSYPMP45160	415
NSYPLS2727AG	11, 184	NSYPMB1012	32, 228	NSYPMP4580	415
NSYPLS2727G	11, 184	NSYPMB105	32, 228	NSYPMP5002DLP	230, 236
NSYPLS2736AG	11, 184	NSYPMB107	32, 228	NSYPMP500DLP	230, 236
NSYPLS2736G	11, 184	NSYPMB1210	32, 228	NSYPMP7502DLP	230, 236
NSYPLS2754AG	11, 184	NSYPMB1212	32, 228	NSYPMP750DLP	230, 236
NSYPLS2754G	11, 184	NSYPMB125	32, 228	NSYPMP85100	27, 415
NSYPLS30	412	NSYPMB127	32, 228	NSYPMP85120	27, 415
NSYPLS3636G	11, 184	NSYPMB1510	32, 228	NSYPMP85160	415
NSYPLS3654AG	11, 184	NSYPMB1512	32, 228	NSYPMP8560	27, 415
NSYPLS3654G	11, 184	NSYPMB155	32, 228	NSYPMP8580	27, 415
NSYPLS3672AG	11, 184	NSYPMB157	32, 228	NSYPMR105	32, 228
NSYPLS5454AG	11, 183, 184	NSYPMB1827	185	NSYPMR107	32, 228
NSYPLS5454G	11, 184	NSYPMB2727	185	NSYPMR125	32, 228
NSYPLS5472AG	11, 184	NSYPMB2736	185	NSYPMR127	32, 228
NSYPLSC1827G	11, 183, 184	NSYPMB2754	185	NSYPMR155	32, 228
NSYPLSC2727AG	11, 184	NSYPMB2754	185	NSYPMR157	32, 228
NSYPLSC2727G	11, 184	NSYPMB3636	185	NSYPMR1827	185
NSYPLSC2736AG	11, 184	NSYPMB3654	185	NSYPMR2727	185
NSYPLSC2736G	11, 184	NSYPMB510	32, 228	NSYPMR2736	185
NSYPLSC2754AG	11, 184	NSYPMB5472	185	NSYPMR2754	185
NSYPLSC2754G	11, 184	NSYPMB55	32, 228	NSYPMR2754	185
NSYPLSC3636G	11, 184	NSYPMB710	32, 228	NSYPMR3654	185
NSYPLSC3654AG	11, 184	NSYPMB712	32, 228	NSYPMR3672	185
NSYPLSC3654G	11, 184	NSYPMB75	32, 228	NSYPMR5454	185
NSYPLSC3672AG	11, 184	NSYPMB77	32, 228	NSYPMR5472	185
NSYPLSC5454AG	11, 184	NSYPMD1510	10, 37	NSYPMR55	32, 228
NSYPLSC5454G	11, 184	NSYPMD2015	10, 37	NSYPMR57	32, 228
NSYPLSC5472AG	11, 183, 184	NSYPMD2520	10, 37	NSYPMR75	32, 228
NSYPLSP1827G	11, 183, 184	NSYPMD3025	10, 37	NSYPMR77	32, 228
NSYPLSP2727G	11, 184	NSYPMM1010	32, 228	NSYPPC54HD	526
NSYPLSP2736G	11, 184	NSYPMM1012	32, 228	NSYPPC56HD	526
NSYPLSP2754G	11, 184	NSYPMM105	32, 228, 328	NSYPPC74HD	526
NSYPLSP3636G	11, 184	NSYPMM107	32, 228, 328	NSYPPC76HD	526
NSYPLSP3654G	11, 184	NSYPMM1210	32, 228	NSYPPCPHDSN	526
NSYPLSP5454G	11, 184	NSYPMM1212	32, 228, 328	NSYPPS166	108
NSYPMA1010	32, 228	NSYPMM125	32, 228, 328	NSYPPS168	108
NSYPMA1012	32, 228	NSYPMM127	32, 228, 328	NSYPPS184	108
NSYPMA105	32, 228	NSYPMM1510	32, 228	NSYPPS185	108
NSYPMA107	32, 228	NSYPMM1512	32, 228, 328	NSYPPS186	108
NSYPMA1210	32, 228	NSYPMM155	32, 228	NSYPPS204	108
NSYPMA1212	32, 228	NSYPMM157	32, 228, 328	NSYPPS205	108
NSYPMA125	32, 228	NSYPMM1827	185	NSYPPS206	108
NSYPMA127	32, 228	NSYPMM207	32, 228, 328	NSYPPS208	108
NSYPMA1827G	185	NSYPMM2727	185	NSYPPS226	108
NSYPMA2727G	185	NSYPMM2736	185	NSYPPS228	108
NSYPMA2736G	185	NSYPMM2754	185	NSYPPSB	41, 44, 140, 141

Index of references

N	Page	N	Page	N	Page
NSYPS2C27	187	NSYRSF124L	521	NSYRSWP6	370
NSYPS4C27	187	NSYRSF125	521	NSYRSWP9	370
NSYPTDS1	433	NSYRSF125L	521	NSYRSWSP6	370
NSYPTDS2	433	NSYRSF126	521	NSYRSWSP8	370
NSYPTDS3	433	NSYRSF126L	521	NSYS12M6H	12, 50
NSYPTDS4	433	NSYRSF128	521	NSYS13M5HS	12, 15, 50, 59, 153, 271
NSYPTDS5	433	NSYRSF128L	521	NSYS16M5HS	153, 247, 271
NSYPTZ3	230	NSYRSF164	521	NSYS16M6H	12, 50
NSYPTZ32P	230	NSYRSF164L	521	NSYS16M6HS	153, 271
NSYPTZ4	33, 227, 230	NSYRSF165	521	NSYS18M6H	12, 50
NSYPTZ42P	230	NSYRSF165L	521	NSYS3CM303020	398, 400, 424
NSYPTZ6	230	NSYRSF166	521	NSYS3CM304020	398, 400, 424
NSYPTZ62P	230	NSYRSF166L	521	NSYS3CM404020	398, 400, 424
NSYPUNX	165	NSYRSF35	521	NSYS3CM406025	398, 400, 424
NSYRC12	369	NSYRSF35L	521	NSYS3CM505025	398, 400, 424
NSYRC14	369	NSYRSF36	521	NSYS3CM606020	398, 400, 424
NSYRC16	369	NSYRSF36L	521	NSYS3CM608030	398, 400, 424
NSYRC18	369	NSYRSF38	521	NSYS3CM806030	398, 400, 424
NSYRC1U	373	NSYRSF38L	521	NSYS3CVR64HD	332, 334, 335, 452, 453
NSYRC20	369	NSYRSF44	521	NSYS3CVR84HD	332, 334, 335, 452, 453
NSYRC22	369	NSYRSF44L	521	NSYS3D101030D	63
NSYRCDFIX	373	NSYRSF45	521	NSYS3D10625	12, 50, 63, 360
NSYRCDR12	374	NSYRSF45L	521	NSYS3D10625T	360
NSYRCDR18	374	NSYRSF64	521	NSYS3D10630	360
NSYRCINT	374	NSYRSF64L	521	NSYS3D10630T	360
NSYRCK19KIT	369	NSYRSF65	521	NSYS3D10640	360
NSYRCK19KIT6G	344	NSYRSF65L	521	NSYS3D10640T	360
NSYRCK24	368	NSYRSF66	521	NSYS3D10825	360
NSYRCK29	368	NSYRSF66L	521	NSYS3D10825T	360
NSYRCK33	368	NSYRSF84	521	NSYS3D10830	63, 360
NSYRCK38	368	NSYRSF84L	521	NSYS3D10830T	360
NSYRCK42	344, 368	NSYRSF85	521	NSYS3D10840	360
NSYRCK47	368	NSYRSF85L	521	NSYS3D10840T	360
NSYRCKP12	368	NSYRSF86	521	NSYS3D12830	360
NSYRCKP17	368	NSYRSF86L	521	NSYS3D12830T	360
NSYRCKP21	368	NSYRSF88	521	NSYS3D12840	360
NSYRCKP26	368	NSYRSF88L	521	NSYS3D12840PK3	353
NSYRCKP4	368	NSYRSFBLR	521	NSYS3D12840T	360
NSYRCKP8	368	NSYRSFLFIX	521	NSYS3D141030D	63
NSYRCKS10	369	NSYRSW27	21, 101, 371	NSYS3D3215	63
NSYRCKS6	369	NSYRSW31	21, 101, 371	NSYS3D32515PK3	353
NSYRCKS8	369	NSYRSW36	21, 101, 371	NSYS3D4320PK3	353
NSYRCSUP15	373	NSYRSW40	21, 101, 371	NSYS3D4620	360
NSYRCSUP25	373	NSYRSW45	371	NSYS3D4620T	360
NSYRE26	122, 460	NSYRSW627	371	NSYS3D4625	360
NSYRE60	122, 460	NSYRSW631	371	NSYS3D4625T	360
NSYRETPLA	224	NSYRSW636	371	NSYS3D5320	63
NSYRETPLAU	224	NSYRSW640	371	NSYS3D5420	63
NSYRP2	407, 409	NSYRSW645	371	NSYS3D6425	63
NSYRPX2	407, 409	NSYRSWC27	21, 101, 372	NSYS3D6525PK3	353
NSYRSF104	521	NSYRSWC31	21, 101, 372	NSYS3D6620	63, 360
NSYRSF104L	521	NSYRSWC36	21, 101, 372	NSYS3D6620T	360
NSYRSF105	521	NSYRSWC40	21, 101, 372	NSYS3D6625	360
NSYRSF105L	521	NSYRSWC45	372	NSYS3D6625T	360
NSYRSF106	521	NSYRSWH180	372	NSYS3D6630	360
NSYRSF106L	521	NSYRSWP12	370	NSYS3D6630T	360
NSYRSF108	521	NSYRSWP15	370	NSYS3D6640	360
NSYRSF108L	521	NSYRSWP18	370	NSYS3D6640T	360
NSYRSF124	521	NSYRSWP21	370	NSYS3D6G12840P	349

Index of references

N	Page	N	Page	N	Page
NSYS3D6G32515P	349	NSYS3DEX3215	390	NSYS3X6625H	12, 26, 50, 152
NSYS3D6G4320P	349	NSYS3DEX3320	390	NSYS3X7525	12, 26, 50, 152
NSYS3D6G6525P	349	NSYS3DEX4320	390	NSYS3X7525H	12, 26, 50, 152
NSYS3D6G7525P	349	NSYS3DEX4420	390	NSYS3X7525T	26, 152
NSYS3D6G8630P	349	NSYS3DEX5420	390	NSYS3X801030	26, 152
NSYS3D7525PK3	353	NSYS3DEX6425	390	NSYS3X801230	26, 152
NSYS3D8620	360	NSYS3DEX6625	390	NSYS3X8625	12, 26, 50, 152
NSYS3D8620T	360	NSYS3DEX7525	390	NSYS3X8625H	12, 26, 50, 152
NSYS3D8625	360	NSYS3DEX8630	390	NSYS3X8625T	26, 152
NSYS3D8625T	360	NSYS3DLG	518, 519, 526	NSYS3X8830	12, 26, 50, 152
NSYS3D8630	63, 360	NSYS3DTL	518	NSYS3X8830H	12, 26, 50, 152
NSYS3D8630PK3	353	NSYS3HD10640	329, 334, 452	NSYSB130	244
NSYS3D8630T	360	NSYS3HD10840	329, 334, 452	NSYSB90	244
NSYS3D8640	360	NSYS3HD3215	329	NSYSBM151512	10, 40, 42
NSYS3D8640T	360	NSYS3HD4320	329	NSYSBM15158	10, 40, 42
NSYS3DB25315	18	NSYS3HD5420	329	NSYSBM152012	10, 40, 42
NSYS3DB25415	18	NSYS3HD6425	329	NSYSBM15208	10, 40, 42
NSYS3DB25515	18	NSYS3HD6630	329	NSYSBM153012	10, 40, 42
NSYS3DB3315	18	NSYS3HD7525	329	NSYSBM15308	10, 40, 42
NSYS3DB3415	18	NSYS3HD8630	329, 334, 452	NSYSBM154012	10, 40, 42
NSYS3DB3515	18	NSYS3HD8840	329, 334, 452	NSYSBM15408	10, 40, 42
NSYS3DB3615	18	NSYS3HF10830P	382	NSYSBM202012	10, 40, 42
NSYS3DB4315	18	NSYS3HF4320P	382	NSYSBM20208	10, 40, 42
NSYS3DB4815	18	NSYS3HF6420P	382	NSYSBM203012	10, 40, 42
NSYS3DB5415	18	NSYS3HF6625P	382	NSYSBM20308	10, 40, 42
NSYS3DB6415	18	NSYS3HF8630P	382	NSYSBM204012	10, 40, 42
NSYS3DC101030	12, 14, 50, 58	NSYS3X101030	26, 152	NSYSBM20408	10, 40, 42
NSYS3DC10625	14, 58	NSYS3X101030H	26, 152	NSYSBM205012	10, 40, 42
NSYS3DC10825	12, 14, 50, 58	NSYS3X10830	12, 26, 50, 152	NSYSBM20508	10, 40, 42
NSYS3DC10830	12, 14, 50, 58	NSYS3X10830H	12, 26, 50, 152	NSYSBM206012	10, 40, 42
NSYS3DC10840	12, 14, 50, 58	NSYS3X10830T	26, 152	NSYSBM20608	10, 40, 42
NSYS3DC121030	12, 14, 50, 58	NSYS3X121030	26, 152	NSYSBM208012	10, 40, 42
NSYS3DC12830	12, 14, 50, 58	NSYS3X121030H	26, 152	NSYSBM303012	10, 40, 42
NSYS3DC12840	12, 14, 50, 58	NSYS3X12830	12, 26, 50, 152	NSYSBM304012	10, 40, 42
NSYS3DC3215	12, 14, 50, 58	NSYS3X12830H	12, 26, 50, 152	NSYSBM305012	10, 40, 42
NSYS3DC3315	12, 14, 50, 58	NSYS3X302515	26, 152	NSYSBM306012	10, 40, 42
NSYS3DC3320	12, 14, 50, 58	NSYS3X302515H	26, 152	NSYSBM308012	10, 40, 42
NSYS3DC4315	12, 14, 50, 58	NSYS3X3215	12, 26, 50, 152	NSYSBM404012	10, 40, 42
NSYS3DC4320	12, 14, 50, 58	NSYS3X3215H	12, 26, 50, 152	NSYSBM405012	10, 40, 42
NSYS3DC4420	12, 14, 50, 58	NSYS3X3315	12, 26, 50, 152	NSYSBM406012	10, 40, 42
NSYS3DC5420	12, 14, 50, 58	NSYS3X3315H	12, 26, 50, 152	NSYSBM408012	10, 40, 42
NSYS3DC5425	12, 14, 50, 58	NSYS3X4315	12, 26, 50, 152	NSYSBMABS4	518
NSYS3DC5520	12, 14, 50, 58	NSYS3X4315H	12, 26, 50, 152	NSYSBMABS6	518
NSYS3DC5525	12, 14, 50, 58	NSYS3X4320	12, 26, 50, 152	NSYSBPLA	231
NSYS3DC6420	12, 14, 50, 58	NSYS3X4320H	12, 26, 50, 152	NSYSBTB	248
NSYS3DC6425	12, 14, 50, 58	NSYS3X4320T	26, 152	NSYSBX15158	10, 140
NSYS3DC6620	12, 14, 50, 58	NSYS3X4420	12, 26, 50, 152	NSYSBX15308	10, 140
NSYS3DC6625	12, 14, 50, 58	NSYS3X4420H	12, 26, 50, 152	NSYSBX20208	10, 140
NSYS3DC6630	12, 14, 50, 58	NSYS3X4620	26, 152	NSYSBX20308	10, 140
NSYS3DC7525	12, 14, 50, 58	NSYS3X4620H	26, 152	NSYSBX204012	10, 140
NSYS3DC8620	12, 14, 50, 58	NSYS3X5420	12, 26, 50, 152	NSYSBX303012	10, 140
NSYS3DC8625	12, 14, 50, 58	NSYS3X5420H	12, 26, 50, 152	NSYSC1030	121
NSYS3DC8630	12, 14, 50, 58	NSYS3X5420T	26, 152	NSYSC1040	121
NSYS3DC8640	12, 14, 50, 58	NSYS3X601030	26, 152	NSYSC1050	121
NSYS3DC8825	12, 14, 50, 58	NSYS3X601230	26, 152	NSYSC1060	121
NSYS3DC8830	12, 14, 50, 58	NSYS3X6420	12, 26, 50, 152	NSYSC1230	121
NSYS3DCGPSTDSB	518, 519, 520	NSYS3X6420H	12, 26, 50, 152	NSYSC1240	121
NSYS3DCGSB	518, 519, 520	NSYS3X6420T	26, 152	NSYSC124HD	527
NSYS3DEX10830	390	NSYS3X6625	12, 26, 50, 152	NSYSC1250	121

Index of references

N	Page	N	Page	N	Page
NSYSC1260	121	NSYSDCR300	15, 17, 26, 59, 77, 152, 392	NSYSF12880E	362
NSYSC126HD	527	NSYSDCR4	299	NSYSF14640	22, 102
NSYSC1640	121	NSYSDCR400	15, 17, 59, 77	NSYSF14640P	22, 102
NSYSC1650	121	NSYSDCR5	299	NSYSF14840	22, 102
NSYSC1660	121	NSYSDCR6	299	NSYSF14840P	22, 102
NSYSC1850	121	NSYSDCR8	299	NSYSF16660	22, 102
NSYSC1860	121	NSYSDCX42	407, 409	NSYSF16660P	22, 102
NSYSC2050	121	NSYSDCX43	407, 409	NSYSF16660PC	419
NSYSC2060	121	NSYSDCX62	407, 409	NSYSF16680	22, 102
NSYSC2450	121	NSYSDCX63	407, 409	NSYSF16680P	22, 102
NSYSC2460	121	NSYSDF1010	405, 410	NSYSF16680PC	419
NSYSC630	121	NSYSDF108	405, 410	NSYSF16860	22, 102
NSYSC640	121	NSYSDF1210	405, 410	NSYSF16860P	22, 102
NSYSC64HD	527	NSYSDF128	405, 410	NSYSF16880	22, 102
NSYSC650	121	NSYSDF1610	405, 410	NSYSF16880P	22, 102
NSYSC660	121	NSYSDF168	405, 410	NSYSF181040	22, 102
NSYSC66HD	527	NSYSDF810	405, 410	NSYSF1810402D	22, 102
NSYSC830	121	NSYSDF88	405, 410	NSYSF1810402DP	22, 102
NSYSC840	121	NSYSDFLOCKDB5	525	NSYSF181040P	22, 102
NSYSC84HD	527	NSYSDGCR10	289	NSYSF181050	22, 102
NSYSC850	121	NSYSDGCR5	289	NSYSF181050P	22, 102
NSYSC860	121	NSYSDGCR6	289	NSYSF181060	22, 102
NSYSC86HD	527	NSYSDGCR8	289	NSYSF1810602D	22, 102
NSYSCCDINLG140	289	NSYSDH	413, 525	NSYSF1810602DP	22, 102
NSYSCCDINLG75	289	NSYSDP6M	127, 298	NSYSF181060P	22, 102
NSYSCMX10030	163	NSYSDP8M	127, 298	NSYSF1812402D	22, 102
NSYSCMX10040	163	NSYSDR100	262	NSYSF1812402DP	22, 102
NSYSCMX12040	163	NSYSDR100A	262	NSYSF1812502D	22, 102
NSYSCMX12050	163	NSYSDR120	262	NSYSF1812502DP	22, 102
NSYSCMX16040	163	NSYSDR200	264	NSYSF1812602D	22, 102
NSYSCMX16060	163	NSYSDR200B	264	NSYSF1812602DP	22, 102
NSYSCMX6040	163	NSYSDR200BD	264	NSYSF18440	22, 102
NSYSCMX8040	163	NSYSDR200D	264	NSYSF18450	22, 102
NSYSCMX8050	163	NSYSDR30B	262	NSYSF18460	22, 102
NSYSCX10060	163	NSYSDR40B	262	NSYSF18640	22, 102
NSYSCX12040	163	NSYSDR50A	262	NSYSF18640P	22, 102
NSYSCX12050	163	NSYSDR60	262	NSYSF18640T	22, 102
NSYSCX12060	163	NSYSDR60A	262	NSYSF18650	22, 102
NSYSCX16040	163	NSYSDR80	262	NSYSF18650P	22, 102
NSYSCX16060	163	NSYSDR80A	262	NSYSF18650T	22, 102
NSYSCX6040	163	NSYSDRC	128	NSYSF18660	22, 102
NSYSCX6050	163	NSYSDT5	128, 299	NSYSF18660P	22, 102
NSYSCX8040	163	NSYSDT6	128, 299	NSYSF18660PC	419
NSYSCX8060	163	NSYSDT8	128, 299	NSYSF18680PC	419
NSYSD10	405, 410	NSYSDX10	27, 406, 409, 410	NSYSF18680T	22, 102
NSYSD10R	406, 409, 410	NSYSDX12	27, 406, 409, 410	NSYSF18840	22, 102
NSYSD12	405, 410	NSYSDX6	27, 406, 409, 410	NSYSF18840P	22, 102
NSYSD12R	406, 409, 410	NSYSDX8	27, 406, 409, 410	NSYSF18840T	22, 102
NSYSD6	405, 410	NSYSF12640	22, 102	NSYSF18850	22, 102
NSYSD6R	406, 409, 410	NSYSF12640P	22, 102	NSYSF18850P	22, 102
NSYSD8	405, 410	NSYSF12660	22, 102	NSYSF18850T	22, 102
NSYSD8R	406, 409, 410	NSYSF12660E	362	NSYSF18860	22, 102
NSYSDC42	407, 409	NSYSF12660P	22, 102	NSYSF188602D	22, 102
NSYSDC43	407, 409	NSYSF12680E	362	NSYSF188602DP	22, 102
NSYSDC62	407, 409	NSYSF12840	22, 102	NSYSF18860P	22, 102
NSYSDC63	407, 409	NSYSF12840P	22, 102	NSYSF18860T	22, 102
NSYSDCR10	299	NSYSF12860	22, 102	NSYSF201040	22, 102
NSYSDCR200	15, 17, 26, 59, 77, 152, 243, 392	NSYSF12860E	362	NSYSF2010402D	22, 102
NSYSDCR250	15, 17, 26, 59, 77, 152, 243, 392	NSYSF12860P	22, 102	NSYSF2010402DP	22, 102

Index of references

N	Page	N	Page	N	Page
NSYSF201040P	22, 102	NSYSF20860T	22, 102	NSYSFC85	24, 25, 104, 105
NSYSF201040T	22, 102	NSYSF20880	22, 102	NSYSFC86	24, 25, 104, 105
NSYSF201050	22, 102	NSYSF20880E	362	NSYSFC88	24, 25, 104, 105
NSYSF2010502D	22, 102	NSYSF20880P	22, 102	NSYSFCVR124HD	332, 334, 335, 452, 453
NSYSF2010502DP	22, 102	NSYSF20880T	22, 102	NSYSFCVR126HD	332, 334, 335, 452, 453
NSYSF201050P	22, 102	NSYSF221060	22, 102	NSYSFCVR64HD	332, 334, 335, 452, 453
NSYSF201050T	22, 102	NSYSF221060P	22, 102	NSYSFCVR66HD	332, 334, 335, 452, 453
NSYSF201060	22, 102	NSYSF2212602D	22, 102	NSYSFCVR84HD	332, 334, 335, 452, 453
NSYSF2010602D	22, 102	NSYSF2212602DP	22, 102	NSYSFCVR86HD	332
NSYSF2010602DP	22, 102	NSYSF2212802D	22, 102	NSYSFD126	24, 104, 106, 125
NSYSF201060P	22, 102	NSYSF2212802DP	22, 102	NSYSFD126T	24, 104
NSYSF201060T	22, 102	NSYSF22460	22, 102	NSYSFD128	24, 104, 106, 125
NSYSF201080	22, 102	NSYSF226100E	362	NSYSFD128T	24, 104
NSYSF201080P	22, 102	NSYSF22660	22, 102	NSYSFD146	24, 104, 106, 125
NSYSF2012402D	22, 102	NSYSF22660E	362	NSYSFD146T	24, 104
NSYSF2012402DP	22, 102	NSYSF22660P	22, 102	NSYSFD148	24, 104, 106, 125
NSYSF2012502D	22, 102	NSYSF22680	22, 102	NSYSFD148T	24, 104
NSYSF2012502DP	22, 102	NSYSF22680E	362	NSYSFD166	24, 104, 106, 125
NSYSF2012602D	22, 102	NSYSF22680P	22, 102	NSYSFD166T	24, 104
NSYSF2012602DP	22, 102	NSYSF228100E	362	NSYSFD168	24, 104, 106, 125
NSYSF2012802D	22, 102	NSYSF22860	22, 102	NSYSFD168T	24, 104
NSYSF2012802DP	22, 102	NSYSF22860E	362	NSYSFD1810	24, 104
NSYSF2016402D	22, 102	NSYSF22860P	22, 102	NSYSFD18102D	24, 104
NSYSF2016402DP	22, 102	NSYSF22880	22, 102	NSYSFD1810T	24, 104
NSYSF2016502D	22, 102	NSYSF22880E	362	NSYSFD18122D	24, 104
NSYSF2016502DP	22, 102	NSYSF22880P	22, 102	NSYSFD18122DT	24, 104
NSYSF2016602D	22, 102	NSYSF22880T	22, 102	NSYSFD184	24, 104, 106, 125
NSYSF2016602DP	22, 102	NSYSF6G20680	343	NSYSFD185	106, 125
NSYSF20350	22, 102	NSYSF6G20860	343	NSYSFD186	24, 104, 106, 125
NSYSF20360	22, 102	NSYSF6G20880	343	NSYSFD186T	24, 104
NSYSF20380	22, 102	NSYSFBK	109	NSYSFD188	24, 104, 106, 125
NSYSF20440	22, 102	NSYSFBK19	27, 109, 165	NSYSFD1882D	24, 104
NSYSF20450	22, 102	NSYSFBKE	109	NSYSFD188T	24, 104
NSYSF20460	22, 102	NSYSFBKF	109	NSYSFD2010	25, 105
NSYSF20480	22, 102	NSYSFBKR	109	NSYSFD20102D	25, 105
NSYSF20640	22, 102	NSYSFBKSH	109	NSYSFD2010T	25, 105
NSYSF20640P	22, 102	NSYSFC104	24, 25, 104, 105	NSYSFD20122D	25, 105
NSYSF20640T	22, 102	NSYSFC105	24, 25, 104, 105	NSYSFD20122DT	25, 105
NSYSF20650	22, 102	NSYSFC106	24, 25, 104, 105	NSYSFD20162D	25, 105
NSYSF20650P	22, 102	NSYSFC108	24, 25, 104, 105	NSYSFD203	25, 105, 125
NSYSF20650T	22, 102	NSYSFC124	24, 25, 104, 105	NSYSFD204	25, 105, 106, 125
NSYSF20660	22, 102	NSYSFC125	24, 25, 104, 105	NSYSFD205	106, 125
NSYSF20660E	362	NSYSFC126	24, 25, 104, 105	NSYSFD206	25, 105, 106, 125
NSYSF20660P	22, 102	NSYSFC128	24, 25, 104, 105	NSYSFD206T	25, 105
NSYSF20680	22, 102	NSYSFC164	25, 105	NSYSFD207	125
NSYSF20680E	362	NSYSFC165	25, 105	NSYSFD208	25, 105, 106, 125
NSYSF20680P	22, 102	NSYSFC166	25, 105	NSYSFD2082D	25, 105
NSYSF208100E	362	NSYSFC35	25, 105	NSYSFD208T	25, 105
NSYSF20840	22, 102	NSYSFC36	25, 105	NSYSFD2210	25, 105
NSYSF20840P	22, 102	NSYSFC38	25, 105	NSYSFD2210T	25, 105
NSYSF20840T	22, 102	NSYSFC44	24, 25, 104, 105	NSYSFD22122D	25, 105
NSYSF20850	22, 102	NSYSFC45	24, 25, 104, 105	NSYSFD22122DT	25, 105
NSYSF20850P	22, 102	NSYSFC46	24, 25, 104, 105	NSYSFD224	25, 105, 106, 125
NSYSF20850T	22, 102	NSYSFC48	24, 25, 104, 105	NSYSFD225	106, 125
NSYSF20860	22, 102	NSYSFC64	24, 25, 104, 105	NSYSFD226	25, 105, 106, 125
NSYSF208602D	22, 102	NSYSFC65	24, 25, 104, 105	NSYSFD226T	25, 105
NSYSF208602DP	22, 102	NSYSFC66	24, 25, 104, 105	NSYSFD228	25, 105, 106, 125
NSYSF20860E	362	NSYSFC68	24, 25, 104, 105	NSYSFD228T	25, 105
NSYSF20860P	22, 102	NSYSFC84	24, 25, 104, 105	NSYSFDHD12122D	527

Index of references

N	Page	N	Page	N	Page
NSYSFDHD126	527	NSYSFPSC80	40, 43, 65, 79, 81	NSYSIMP22	23, 103, 247
NSYSFDHD128	527	NSYSFRSEDC1268E	377	NSYSLCKP	437
NSYSFDHD16122D	527	NSYSFRSEDC261E	377	NSYSLCKS10	437
NSYSFDHD166	527	NSYSFRSEDC268E	377	NSYSLCKS6	437
NSYSFDHD168	527	NSYSFRSEDC2812E	377	NSYSLCKS8	437
NSYSFDHD208	527	NSYSFRSEDC281E	377	NSYSLCR40	256
NSYSFEB	120	NSYSFSPLMG	29, 202	NSYSLCR50	256
NSYSFECA64HD	527	NSYSFTB16	120	NSYSLCR60	256
NSYSFECA66HD	334, 335, 452, 453, 527	NSYSFTB18	120	NSYSLCR80	256
NSYSFELB	120	NSYSFTB24	120	NSYSM10M5HP	293
NSYSFHD1212402D	329, 334, 452	NSYSFTB32	120	NSYSM1210302D	20, 100
NSYSFHD1212602D	329, 334, 452	NSYSFV12	24, 104	NSYSM1210302DP	20, 100
NSYSFHD12640	329, 334, 452	NSYSFV14	24, 104	NSYSM1212402D	20, 100
NSYSFHD12660	329, 334, 452	NSYSFV16	24, 104	NSYSM1212402DP	20, 100
NSYSFHD12840	329, 334, 452	NSYSFV18	24, 104	NSYSM12830	20, 100
NSYSFHD12860	329, 334, 452	NSYSFV20	25, 105	NSYSM12830P	20, 100
NSYSFHD1612402D	329, 334, 452	NSYSFV22	25, 105	NSYSM1410402D	20, 100
NSYSFHD1612602D	329, 334, 452	NSYSFWFIX	124	NSYSM1410402DP	20, 100
NSYSFHD16660	329, 334, 452	NSYSFX181240	27, 161	NSYSM1412402D	20, 100
NSYSFHD16840	329, 334, 452	NSYSFX18640	27, 161	NSYSM1412402DP	20, 100
NSYSFHD16860	329, 334, 452	NSYSFX18840	27, 161	NSYSM14630	20, 100
NSYSFHD2	131	NSYSFX201060	27, 161	NSYSM14630P	20, 100
NSYSFHD20840	329, 334, 452	NSYSFX201260	27, 161	NSYSM14640	20, 100
NSYSFHD3	131	NSYSFX20650	27, 161	NSYSM14640P	20, 100
NSYSFHFBK184	384	NSYSFX20840	27, 161	NSYSM14830	20, 100
NSYSFHFBK186	384	NSYSFX20860	27, 161	NSYSM14830P	20, 100
NSYSFHFBK2010	384	NSYSFXJG	27, 165	NSYSM14840	20, 100
NSYSFHFBK204	384	NSYSGF	114	NSYSM14840P	20, 100
NSYSFHFBK206	384	NSYSH180NC	128	NSYSM14840T	20, 100
NSYSFHFBK208	384	NSYSHLT6040	260	NSYSM1610302D	20, 100
NSYSFHFBK226	384	NSYSHLT6060	260	NSYSM1610302DP	20, 100
NSYSFHFBK228	384	NSYSHLT6080	260	NSYSM1610402D	20, 100
NSYSFHINTRIM	521, 522	NSYSHLT8040	260	NSYSM1610402DP	20, 100
NSYSFHBP	129	NSYSHLT8060	260	NSYSM1612302D	20, 100
NSYSFHS1	129, 521	NSYSHLT8080	260	NSYSM1612302DP	20, 100
NSYSFHS1HD	527	NSYSIBTB	248	NSYSM1612402D	20, 100
NSYSFLOCK24	130	NSYSICR40100	256	NSYSM1612402DP	20, 100
NSYSFLOCKDB5	130	NSYSICR4040	256	NSYSM16630	20, 100
NSYSFLOCKS6	130	NSYSICR4050	256	NSYSM16630P	20, 100
NSYSFLOCKS7	130	NSYSICR4060	256	NSYSM16640	20, 100
NSYSFLOCKS8	130	NSYSICR4080	256	NSYSM16640P	20, 100
NSYSFLOCKSG8	130	NSYSICR65100	256	NSYSM16640T	20, 100
NSYSFLOCKT6	130	NSYSICR6530	256	NSYSM16830	20, 100
NSYSFLOCKT7	130	NSYSICR6540	256	NSYSM16830P	20, 100
NSYSFLOCKT8	130	NSYSICR6550	256	NSYSM16830T	20, 100
NSYSFMDR	299	NSYSICR6560	256	NSYSM16840	20, 100
NSYSFNDR	299	NSYSICR6580	256	NSYSM16840P	20, 100
NSYSFP300	29, 202	NSYSICR90100	256	NSYSM16840T	20, 100
NSYSFP400	29, 202	NSYSICR90120	256	NSYSM181040	20, 100
NSYSFP500	29, 202	NSYSICR9030	256	NSYSM1810402D	20, 100
NSYSFP600	29, 202	NSYSICR9040	256	NSYSM1810402DP	20, 100
NSYSFPB	248	NSYSICR9050	256	NSYSM181040P	20, 100
NSYSFPB6G	344	NSYSICR9060	256	NSYSM1810502D	20, 100
NSYSFPSC15	40, 43	NSYSICR9080	256	NSYSM1810502DP	20, 100
NSYSFPSC20	40, 43	NSYSIMP12	23, 103, 247	NSYSM1812402D	20, 100
NSYSFPSC30	40, 43, 65, 79, 81	NSYSIMP14	23, 103, 247	NSYSM1812402DP	20, 100
NSYSFPSC40	40, 43, 65, 79, 81	NSYSIMP16	23, 103, 247	NSYSM1812502D	20, 100
NSYSFPSC50	40, 43, 65, 79, 81	NSYSIMP18	23, 103, 247	NSYSM1812502DP	20, 100
NSYSFPSC60	40, 43, 65, 79, 81	NSYSIMP20	23, 103, 247	NSYSM1816402D	20, 100

Index of references

N	Page	N	Page	N	Page
NSYSM1816402DP	20, 100	NSYSMBK	109	NSYSMWFIX	124
NSYSM1816502D	20, 100	NSYSMD12102D	522	NSYSMX141030	27, 161
NSYSM1816502DP	20, 100	NSYSMD12122D	522	NSYSMX16660PC	423
NSYSM18630	20, 100	NSYSMD14102D	522	NSYSMX16840	27, 161
NSYSM18630P	20, 100	NSYSMD14122D	522	NSYSMX181240	27, 161
NSYSM18640	20, 100	NSYSMD16102D	522	NSYSMX181240H	27, 161
NSYSM18640P	20, 100	NSYSMD16122D	522	NSYSMX181640	27, 161
NSYSM18640T	20, 100	NSYSMD18162D	522	NSYSMX181640H	27, 161
NSYSM18650	20, 100	NSYSMDR	299	NSYSMX18640	27, 161
NSYSM18650P	20, 100	NSYSMEB	120	NSYSMX18660PC	423
NSYSM18830	20, 100	NSYSMEC103	116	NSYSMX18840	27, 161
NSYSM18830P	20, 100	NSYSMEC1031	522	NSYSMX18840H	27, 161
NSYSM18830T	20, 100	NSYSMEC104	116	NSYSMX201040	27, 161
NSYSM18840	20, 100	NSYSMEC1041	522	NSYSMX201040H	27, 161
NSYSM18840P	20, 100	NSYSMEC105	116	NSYSMX201250	27, 161
NSYSM18840T	20, 100	NSYSMEC1051	522	NSYSMX201250H	27, 161
NSYSM18850	20, 100	NSYSMEC63	116	NSYSMX201660	27, 161
NSYSM18850P	20, 100	NSYSMEC631	522	NSYSMX201660H	27, 161
NSYSM18850T	20, 100	NSYSMEC64	116	NSYSMX20850	27, 161
NSYSM18860	20, 100	NSYSMEC641	522	NSYSMXEB	165
NSYSM18860P	20, 100	NSYSMEC65	116	NSYSNLPLA	224
NSYSM2010402D	20, 100	NSYSMEC651	522	NSYSNM6	251, 265, 270
NSYSM2010402DP	20, 100	NSYSMEC66	116	NSYSNM8	251, 265, 270
NSYSM2010502D	20, 100	NSYSMEC661	522	NSYSNSM6	251, 265, 270
NSYSM2010502DP	20, 100	NSYSMEC83	116	NSYSNSM8	251, 265, 270
NSYSM2012402D	20, 100	NSYSMEC831	522	NSYSODS	437
NSYSM2012402DP	20, 100	NSYSMEC84	116	NSYSPB6100	113
NSYSM2012502D	20, 100	NSYSMEC841	522	NSYSPB8100	113
NSYSM2012502DP	20, 100	NSYSMEC85	116	NSYSPC	293
NSYSM2012602D	20, 100	NSYSMEC851	522	NSYSPCD	293
NSYSM2012602DP	20, 100	NSYSMEC86	116	NSYSPCP	13, 51, 293
NSYSM2016402D	20, 100	NSYSMEC861	522	NSYSPCR	114
NSYSM2016402DP	20, 100	NSYSMHR10	258	NSYSPF10100	20, 23, 78, 83, 100, 103, 112, 410
NSYSM2016502D	20, 100	NSYSMHR12	258	NSYSPF10200	21, 23, 78, 83, 101, 103, 112, 363, 410
NSYSM2016502DP	20, 100	NSYSMHR16	258	NSYSPF12100	20, 23, 78, 83, 100, 103, 112, 410
NSYSM2016602D	20, 100	NSYSMHR6	258	NSYSPF12200	21, 23, 78, 83, 101, 103, 112, 410
NSYSM2016602DP	20, 100	NSYSMHR8	258	NSYSPF16100	20, 23, 100, 103, 112, 410
NSYSM20630	20, 100	NSYSMNRD	299	NSYSPF16200	21, 23, 101, 103, 112, 410
NSYSM20630P	20, 100	NSYSMP2D4	250	NSYSPF3100	23, 103, 112
NSYSM20640	20, 100	NSYSMP2D5	250	NSYSPF3200	23, 103, 112
NSYSM20640P	20, 100	NSYSMP2D6	250	NSYSPF4100	23, 103, 112
NSYSM20640T	20, 100	NSYSMP2D8	250	NSYSPF4200	23, 103, 112
NSYSM20650	20, 100	NSYSMPB	248	NSYSPF6100	20, 23, 78, 83, 100, 103, 112, 363, 410, 420
NSYSM20650P	20, 100	NSYSMPFA	247	NSYSPF6200	21, 23, 78, 83, 101, 103, 112, 363, 410, 420
NSYSM20830	20, 100	NSYSMPFB	247	NSYSPF8100	20, 23, 78, 83, 100, 103, 112, 363, 410
NSYSM20830P	20, 100	NSYSMPFS4	248	NSYSPF8200	21, 23, 78, 83, 101, 103, 112, 363, 410
NSYSM20830T	20, 100	NSYSMPFS5	248	NSYSPFV6100	113, 364
NSYSM20840	20, 100	NSYSMPFS6	248	NSYSPFV8100	113, 364
NSYSM20840P	20, 100	NSYSMPFS8	248	NSYSPFVX12200	331, 335, 453
NSYSM20840T	20, 100	NSYSMPFSB	248	NSYSPFVX6200	331, 335, 453
NSYSM20850	20, 100	NSYSMPSE10	249	NSYSPFVX8200	331, 335, 453
NSYSM20850P	20, 100	NSYSMPSE12	249	NSYSPFX10100	27, 83, 153, 162, 410
NSYSM20850T	20, 100	NSYSMPSE6	249	NSYSPFX10100H	83, 153, 162
NSYSM20860	20, 100	NSYSMPSE8	249	NSYSPFX10200	27, 83, 153, 162, 410
NSYSM20860P	20, 100	NSYSMVR12	258		
NSYSM20860T	20, 100	NSYSMVR14	258		
NSYSMBCE10	119	NSYSMVR16	258		
NSYSMBCE6	119	NSYSMVR18	258		
NSYSMBCE8	119	NSYSMVR20	258		

Index of references

N	Page	N	Page	N	Page
NSYSPFX10200H	83, 153, 162	NSYSPS6200SD	411	NSYSTDCXH	155
NSYSPFX12100	27, 162, 410	NSYSPS8100	23, 103, 112, 363, 420	NSYSTDNCSX	155
NSYSPFX12100H	162	NSYSPS8200	23, 103, 112, 363, 420	NSYSTMP22100	246
NSYSPFX12200	27, 162, 331, 410	NSYSPSJ	297	NSYSTMP22120	246
NSYSPFX12200H	162	NSYSPSX3100	27, 83, 153, 162	NSYSTMP2260	246
NSYSPFX16100	27, 162	NSYSPSX3100H	83, 153, 162	NSYSTMP2280	246
NSYSPFX16100H	162	NSYSPSX3200	27, 83, 153, 162, 331, 335, 453	NSYSTMP45100	246
NSYSPFX16200	27, 162	NSYSPSX3200H	83, 153, 162	NSYSTMP45120	246
NSYSPFX16200H	162	NSYSPSX4100	27, 162	NSYSTMP4560	246
NSYSPFX6100	27, 162, 410, 423	NSYSPSX4100H	162	NSYSTMP4580	246
NSYSPFX6100H	162	NSYSPSX4100SF	27, 162	NSYSTMP60100	246, 416
NSYSPFX6200	27, 162, 331, 410, 423	NSYSPSX4200	27, 162, 331	NSYSTMP60120	246, 416
NSYSPFX6200H	162	NSYSPSX4200H	162	NSYSTMP6060	246
NSYSPFX8100	27, 83, 153, 162, 410	NSYSPSX4200SF	27, 162, 331	NSYSTMP6080	246, 416
NSYSPFX8100H	83, 153, 162	NSYSPSX5100	27, 162, 411	NSYSTMP6080	246, 416
NSYSPFX8200	27, 83, 153, 162, 331, 410	NSYSPSX5100H	162	NSYSTMP82100	246
NSYSPFX8200H	83, 153, 162	NSYSPSX5100SF	27, 162	NSYSTMP82120	246
NSYSPLA100	33, 227, 231	NSYSPSX5200	27, 162, 411	NSYSTMP8260	246
NSYSPLA125	33, 227, 231	NSYSPSX5200H	162	NSYSTMP8280	246
NSYSPLA150	33, 227, 231	NSYSPSX5200SF	27, 162	NSYSTW	297
NSYSPLA75	33, 227, 231	NSYSPSX6100	27, 162, 423	NSYSUCR40100	254
NSYSPLK	115	NSYSPSX6100H	162	NSYSUCR40110	115, 254
NSYSPLVX3200	331	NSYSPSX6100SF	27, 162	NSYSUCR40120	254
NSYSPLVX4200	331, 335, 453	NSYSPSX6200	27, 162, 423	NSYSUCR40140	254
NSYSPLVX4200SF	331	NSYSPSX6200H	162	NSYSUCR40160	254
NSYSPLVX6200	335, 453	NSYSPSX6200SF	27, 162, 331	NSYSUCR40180	254
NSYSPLVX6200SF	331	NSYSPV6100	113, 364	NSYSUCR40200	254
NSYSPM6	115	NSYSPV8100	113, 364	NSYSUCR40220	254
NSYSPMP25100	229, 246	NSYSQCR12040	255, 521	NSYSUCR4030	115, 254
NSYSPMP25120	246	NSYSQCR12050	255, 521	NSYSUCR4040	115, 254, 259
NSYSPMP2560	246	NSYSQCR12060	255, 521	NSYSUCR4050	115, 254, 259
NSYSPMP2575	229, 246	NSYSQCR12080	255, 521	NSYSUCR4060	254, 259, 420
NSYSPMP2580	246	NSYSQCR40100	255	NSYSUCR4070	115, 254
NSYSPMP40100	229, 246, 416	NSYSQCR40120	255	NSYSUCR4080	254, 259, 420
NSYSPMP40120	246, 416	NSYSQCR4040	255, 259	NSYSUCR4090	115, 254
NSYSPMP40160	246, 416	NSYSQCR4050	255, 259	NSYSUCR65100	254
NSYSPMP4060	246	NSYSQCR4060	255, 259	NSYSUCR65120	254
NSYSPMP4080	246, 416	NSYSQCR4080	255, 259	NSYSUCR65140	254
NSYSPMP60100	246	NSYSQCR65100	255	NSYSUCR65160	254
NSYSPMP60120	246	NSYSQCR65120	255	NSYSUCR65180	254
NSYSPMP6060	246	NSYSQCR6540	255	NSYSUCR65200	254
NSYSPMP6080	246	NSYSQCR6550	255	NSYSUCR65220	254
NSYSPRJ	297	NSYSQCR6560	255	NSYSUCR6530	254
NSYSPS10100	363	NSYSQCR6580	255	NSYSUCR6540	254
NSYSPS3100	20, 100, 112	NSYSQCR90100	255	NSYSUCR6550	254
NSYSPS3100SD	78, 83	NSYSQCR90120	255	NSYSUCR6560	254
NSYSPS3200	21, 101, 112	NSYSQCR9040	255	NSYSUCR6580	254
NSYSPS3200SD	78, 83	NSYSQCR9050	255	NSYSUCR90100	254
NSYSPS4100	20, 23, 100, 103, 112	NSYSQCR9060	255	NSYSUCR90110	115, 254
NSYSPS4100SD	78, 83, 411	NSYSQCR9080	255	NSYSUCR90120	254
NSYSPS4200	21, 23, 101, 103, 112	NSYST30M6	271	NSYSUCR90140	254
NSYSPS4200SD	78, 83, 411	NSYST30M6S	271	NSYSUCR90160	254
NSYSPS5100	20, 23, 100, 103, 112	NSYST40M8	271	NSYSUCR90180	254
NSYSPS5100SD	411	NSYSTBR3	250	NSYSUCR90200	254
NSYSPS5200	21, 23, 101, 103, 112	NSYSTBR4	250	NSYSUCR90220	254
NSYSPS5200SD	411	NSYSTBR5	250	NSYSUCR9030	115, 254
NSYSPS6100	20, 23, 100, 103, 112, 363, 420	NSYSTBR6	250	NSYSUCR9040	115, 254
NSYSPS6100SD	411	NSYSTDCSX	155	NSYSUCR9050	115, 254
NSYSPS6200	21, 23, 101, 103, 112, 363, 420	NSYSTDCX2H	155	NSYSUCR9060	254
				NSYSUCR9070	115, 254

Index of references

N	Page	N	Page	N	Page
NSYSUCR9080	254	NSYTBS191210HT	11, 172	NSYTEDB5PL	207
NSYSUCR9090	115, 254	NSYTBS19128	11, 172	NSYTEL1242EPL	207
NSYSUPLA3G	218	NSYTBS19128T	11, 172	NSYTEL405ML	87
NSYSUPLA3TG	218	NSYTBS191610H	11, 172	NSYTEL405PL	207
NSYSUPLA4G	218	NSYTBS191610HT	11, 172	NSYTELFACPL	207
NSYSUPLA4TG	218	NSYTBS19168	11, 172	NSYTELJISPL	207
NSYSVR606	122, 368	NSYTBS19168T	11, 172	NSYTEMPL	207
NSYSVR608	122, 368	NSYTBS241910	11, 172	NSYTERML	87
NSYSVR806	122, 368	NSYTBS241910H	11, 172	NSYTERPL	207
NSYSVR808	122, 368	NSYTBS241910HT	11, 172	NSYTET6PL	207
NSYSW	297	NSYTBS241910T	11, 172	NSYTET7ML	87
NSYSWMBP	518, 519, 520, 526	NSYTBS241912H	11, 172	NSYTET8ML	87
NSYSWMCH	518, 519, 520, 526	NSYTBS241912HT	11, 172	NSYTET8PL	207
NSYSWMEL	518, 519, 520, 525, 526	NSYTBS24198	11, 172	NSYTEX5	209
NSYTBP11116	11, 172	NSYTBS24198T	11, 172	NSYTEX6	209
NSYTBP1176	11, 172	NSYTBS292412	11, 172	NSYTEX8	228, 231
NSYTBP1397	11, 172	NSYTBS292412H	11, 172	NSYTEX8PLM	209
NSYTBP1397T	11, 172	NSYTBS292412HT	11, 172	NSYTFPCR10	15, 59, 289
NSYTBP16128	11, 172	NSYTBS292412T	11, 172	NSYTFPCR4	15, 59, 289
NSYTBP16128T	11, 172	NSYTBS292416H	11, 172	NSYTFPCR5	15, 59, 289
NSYTBP191210H	11, 172	NSYTBS292416HT	11, 172	NSYTFPCR6	15, 59, 289
NSYTBP191210HT	11, 172	NSYTBS29248	11, 172	NSYTFPCR8	15, 59, 289
NSYTBP19128	11, 172	NSYTBS29248T	11, 172	NSYTHL1242EPLM	206
NSYTBP19128T	11, 172	NSYTBS342912	11, 172	NSYTHL2331APLM	206
NSYTBP191610H	11, 172	NSYTBS342912T	11, 172	NSYTHL2433APLM	206
NSYTBP191610HT	11, 172	NSYTBS342916H	11, 172	NSYTHL3113APLM	206
NSYTBP19168	11, 172	NSYTBS342916HT	11, 172	NSYTHL3131APLM	206
NSYTBP19168T	11, 172	NSYTBS775	11, 172	NSYTHL405PLM	206
NSYTBP241910	11, 172	NSYTBS885	11, 172	NSYTHL421PLM	206
NSYTBP241910H	11, 172	NSYTC12100	291	NSYTHL455PLM	206
NSYTBP241910HT	11, 172	NSYTC6CRN	86, 206	NSYTHPLM	206
NSYTBP241910T	11, 172	NSYTC6CSX	155	NSYTJ10030	15, 59, 66, 79, 85
NSYTBP241912H	11, 172	NSYTC6ME	163, 206	NSYTJ10040	66, 79, 85
NSYTBP241912HT	11, 172	NSYTC6ML	87	NSYTJ12030	66, 79, 85
NSYTBP24198	11, 172	NSYTC7CRN	86, 206, 413	NSYTJ12040	66, 79, 85
NSYTBP24198T	11, 172	NSYTC7CSX	155	NSYTJ2015	15, 59, 66, 79, 85
NSYTBP292412	11, 172	NSYTC7ML	87	NSYTJ2015HD	527
NSYTBP292412H	11, 172	NSYTC8CRN	86, 206, 413	NSYTJ2515	66, 79, 85
NSYTBP292412HT	11, 172	NSYTC8ME	163, 206	NSYTJ2520	66, 79, 85
NSYTBP292412T	11, 172	NSYTC8ML	87	NSYTJ3015	15, 59, 66, 79, 85
NSYTBP292416H	11, 172	NSYTC274	188	NSYTJ3020	15, 59, 66, 79, 85
NSYTBP292416HT	11, 172	NSYTC276	188	NSYTJ3020HD	527
NSYTBP29248	11, 172	NSYTC278	188	NSYTJ4015	66, 79, 85
NSYTBP29248T	11, 172	NSYTCL405ME	163, 206	NSYTJ4020	15, 59, 66, 79, 85
NSYTBP342912	11, 172	NSYTCL610ME	163	NSYTJ4020HD	527
NSYTBP342912T	11, 172	NSYTCM274	188	NSYTJ4025	15, 59, 66, 79, 85
NSYTBP342916H	11, 172	NSYTCRE1	520	NSYTJ4025HD	527
NSYTBP342916HT	11, 172	NSYTCRE12	520	NSYTJ5015	66, 79, 85
NSYTBP775	11, 172	NSYTC6PLM	208	NSYTJ5020	15, 59, 66, 79, 85
NSYTBP885	11, 172	NSYTC8PLM	12, 50, 199, 208	NSYTJ5025	15, 59, 66, 79, 85
NSYTBS111113H	11, 172	NSYTCT274	188	NSYTJ5025HD	527
NSYTBS11116	11, 172	NSYTDB5ME	163, 206	NSYTJ6020	15, 59, 66, 79, 85
NSYTBS1176	11, 172	NSYTDB5PL	207	NSYTJ6025	15, 59, 66, 79, 85
NSYTBS1179H	11, 172	NSYTDBCRN	86	NSYTJ6030	15, 59, 66, 79, 85
NSYTBS1397	11, 172	NSYTDSSF2D	521, 522, 523, 524	NSYTJ6030HD	527
NSYTBS1397T	11, 172	NSYTEC6PL	207	NSYTJ6040	15, 59, 66, 79, 85
NSYTBS16128	11, 172	NSYTEC7PL	207	NSYTJ6040HD	527
NSYTBS16128T	11, 172	NSYTEC8ML	87	NSYTJ8020	66, 79, 85
NSYTBS191210H	11, 172	NSYTEDB5ML	87	NSYTJ8025	15, 59, 66, 79, 85

Index of references

N	Page	N	Page	N	Page
NSYTJ8030	15, 59, 66, 79, 85	NSYTPLS2736A	185	NSYTTG50	259
NSYTJ8040	15, 59, 66, 79, 85	NSYTPLS2754	184	NSYTTG60	259, 420
NSYTJ8040HD	527	NSYTPLS2754A	185	NSYTVR10	229, 251
NSYTJIS	206	NSYTPLS3636	184	NSYTVR12	21, 23, 101, 103, 251
NSYTJPLA103G	33, 219	NSYTPLS3654	184	NSYTVR125	229, 251
NSYTJPLA104G	33, 219	NSYTPLS3654A	185	NSYTVR14	21, 23, 101, 103, 165, 251, 417
NSYTJPLA123G	33, 219	NSYTPLS3672A	185	NSYTVR15	229, 251
NSYTJPLA124G	33, 219	NSYTPLS5454	184	NSYTVR16	21, 23, 101, 103, 165, 251
NSYTJPLA126G	33, 219	NSYTPLS5454A	185	NSYTVR18	21, 23, 101, 103, 165, 251
NSYTJPLA53G	33, 219	NSYTPLS5472A	185	NSYTVR20	21, 23, 101, 103, 165, 251
NSYTJPLA54G	33, 219	NSYTPLSC1827G	184	NSYTVR22	23, 103, 251
NSYTJPLA73G	33, 219	NSYTPLSC2727AG	185	NSYTVR7	229, 251
NSYTJPLA74G	33, 219	NSYTPLSC2727G	184	NSYTVR8	251, 417
NSYTJPLA76G	33, 219	NSYTPLSC2736AG	185	NSYTX10030	26, 154
NSYTL1242EME	163	NSYTPLSC2736G	184	NSYTX12030	26, 154
NSYTL220PLM	206	NSYTPLSC2754AG	185	NSYTX2015	26, 154
NSYTL27270G	187	NSYTPLSC2754G	184	NSYTX2515	26, 154
NSYTL27360G	187	NSYTPLSC3636G	184	NSYTX3015	26, 154
NSYTL405PLM	206	NSYTPLSC3654AG	185	NSYTX3020	26, 154
NSYTL405SML	87	NSYTPLSC3654G	184	NSYTX4020	26, 154
NSYTLAUHD	527	NSYTPLSC3672AG	185	NSYTX5025	26, 154
NSYTLBFL	285	NSYTPLSC5454AG	185	NSYTX6020	26, 154
NSYTL C	123	NSYTPLSC5454G	184	NSYTX6025	26, 154
NSYTL CFL	123, 285	NSYTPLSC5472AG	185	NSYTX8030	26, 154
NSYTL CRNA	17, 77, 88	NSYTPLSP1827G	184	NSYUCA22	266, 312
NSYTL CRNB	17, 77, 88	NSYTPLSP2727G	184	NSYUCA44	266, 312
NSYTL CRNC	17, 77, 88	NSYTPLSP2736G	184	NSYUCC270	187
NSYTL CRND	17, 77, 88	NSYTPLSP2754G	184	NSYUCC360	187
NSYTL CRNO	17, 77, 88	NSYTPLSP3636G	184	NSYUM27180	187
NSYTL CU	123	NSYTPLSP3654G	184	NSYUM27270	187
NSYTL CUHD	527	NSYTPLSP5454G	184	NSYUM27360	187
NSYTL D	17, 77, 89	NSYTS A2414SE	281	NSYUR20	267, 312
NSYTL DFL	17, 77, 89, 285	NSYTS A2417SE	281	NSYUR40	267, 312
NSYTL DME	17, 77	NSYTS A2422SE	281	NSYUR60	267, 312
NSYTL DUHD	527	NSYTS A2423SE	281	NSYUT20	267, 312
NSYTL E	17, 77, 89	NSYTS A2429SE	281	NSYUT40	267, 312
NSYTL EFL	17, 77, 89, 285	NSYTS AC RNA	17, 70, 77, 88	NSYUT60	267, 312
NSYTL EME	17, 77	NSYTS AC RNB	17, 70, 77, 88	NSYUTA22	266, 312
NSYTL EUHD	527	NSYTS AC RNC	17, 70, 77, 88	NSYUTA42	266, 312
NSYTL F2FL	285	NSYTS AC RND	17, 70, 77, 88	NSYUTA44	266, 312
NSYTL FFL	285	NSYTS AKFL	273, 281	NSYU VPLA	218
NSYTL G	17, 77, 89	NSYTS AM504SE	280	NSYVA2710M	301
NSYTL G2FL	17, 77, 89, 285	NSYTS AM508SE	280	NSYVA2710MA	301
NSYTL G4FL	277, 285	NSYTS AM6313SE	280	NSYVA2712M	301
NSYTL GFL	285	NSYTS AM638SE	280	NSYVA2712MA	301
NSYTL GME	17, 77	NSYTS ML	87, 155	NSYVA2716M	301
NSYTL GUHD	527	NSYTS P450	366	NSYVA2724M	301
NSYTL JISME	163, 206	NSYTS PC450	366	NSYVA272M	301
NSYTL K2414	283	NSYTS PLA	225	NSYVA272MA	301
NSYTL K2422	283	NSYTS PV450	366	NSYVA2736M	13, 51
NSYTL K2428	283	NSYTT6CRN	86, 206	NSYVA274M	13, 51, 301
NSYTL K2446	283	NSYTT6ME	163, 206	NSYVA274MA	301
NSYTL K24M	283	NSYTT7CRN	86	NSYVA276M	301
NSYTL RME	163, 206	NSYTT7ML	87	NSYVA276MA	301
NSYTMME	163, 206	NSYTT8CRN	86, 206, 413	NSYVA278M	301
NSYTPLS1827	184	NSYTT8CSX	155	NSYVA278MA	301
NSYTPLS2727	184	NSYTT8ME	163, 206	NSYVD2M10U4	18, 359, 375
NSYTPLS2727A	185	NSYTT8ML	87	NSYVD2M10U5	18, 359, 375
NSYTPLS2736	184	NSYTTG40	259	NSYVD2M14U4	18, 359, 375

Index of references

N	Page
NSYVD2M14U5	18, 359, 375
NSYVD2M17U4	18, 359, 375
NSYVD2M17U5	18, 359, 375
NSYVD2M5U4	18, 359, 375
NSYVD2M5U5	18, 359, 375
NSYVD2M8U4	18, 359, 375
NSYVD2M8U5	18, 359, 375
NSYVDM10U4F	18, 359
NSYVDM11UP	15, 59, 78, 269, 361
NSYVDM12UF	15, 59, 78, 269, 361
NSYVDM13U4P	18, 359
NSYVDM14U4F	18, 359
NSYVDM16U4P	18, 359
NSYVDM16UP	15, 59, 78, 269, 361
NSYVDM17U4F	18, 359
NSYVDM17UF	15, 59, 78, 269, 361
NSYVDM20U8P	15, 59, 78, 269, 361
NSYVDM20UP	15, 59, 78, 269, 361
NSYVDM21UF	15, 59, 78, 269, 361
NSYVDM25U8P	15, 59, 78, 269, 361
NSYVDM4U4P	18, 359
NSYVDM5U4F	18, 359
NSYVDM7U4P	18, 359
NSYVDM7UP	78, 269, 361
NSYVDM8U4F	18, 359
NSYVDM8UF	78, 269, 361
NSYVDM9U4P	18, 359
NSYVEA9	209
NSYVPHD10	526
NSYVPHD12	526
NSYVPHD15	526
NSYVPHD5	526
NSYVPHD7	526
NSYVPLA10MG	524
NSYVPLA12MG	524
NSYVPLA15MG	524
NSYVPLA5MG	524
NSYVPLA7MG	524
NSYVPLM108	199, 525
NSYVR18	21, 23, 101, 103, 165, 251
NSYVR20	21, 23, 101, 103, 165, 251
NSYVR22	23, 103, 251
NSYWMK33	65, 79, 82
NSYWMK34	65, 79, 82
NSYWMK43	65, 79, 82
NSYWMK44	65, 79, 82
NSYZA2103G	33, 220
NSYZA2104G	33, 220
NSYZA2123G	33, 220
NSYZA2124G	33, 220
NSYZA2126G	33, 220
NSYZA253G	33, 220
NSYZA254G	33, 220
NSYZA273G	33, 220
NSYZA274G	33, 220
NSYZA276G	33, 220
NSYZHPLA103G	33, 223
NSYZHPLA104G	33, 223
NSYZHPLA123G	33, 223

N	Page
NSYZHPLA124G	33, 223
NSYZHPLA53G	33, 223
NSYZHPLA54G	33, 223
NSYZHPLA73G	33, 223
NSYZHPLA74G	33, 223
NSYZM253G	29, 201
NSYZM263G	29, 201
NSYZM283G	29, 201
NSYZNPLA103G	33, 221
NSYZNPLA104G	33, 221
NSYZNPLA123G	33, 221
NSYZNPLA124G	33, 221
NSYZNPLA53G	33, 221
NSYZNPLA54G	33, 221
NSYZNPLA73G	33, 221
NSYZNPLA74G	33, 221
NSYZZ2103G	33, 222
NSYZZ2104G	33, 222
NSYZZ2123G	33, 222
NSYZZ2124G	33, 222, 327
NSYZZ2124VHD	327, 335, 453
NSYZZ2126G	33, 222, 327
NSYZZ2126VHD	327, 335, 453
NSYZZ253G	33, 222
NSYZZ254G	33, 222, 327
NSYZZ254VHD	327, 335, 453
NSYZZ273G	33, 222
NSYZZ274G	33, 222, 327
NSYZZ274VHD	327, 335, 453
NSYZZ276G	33, 222, 327
NSYZZ276VHD	327, 335, 453
NSYZZ5103G	33, 222
NSYZZ5104G	33, 222
NSYZZ5123G	33, 222
NSYZZ5124G	33, 222
NSYZZ553G	33, 222
NSYZZ554G	33, 222
NSYZZ573G	33, 222
NSYZZ574G	33, 222

X	Page
XALE2	173
XALE2141	173
XALE3	173
XALE3255	173
XALEK170	173
XALEK1702	173

Life Is On

Schneider
Electric

Schneider Electric USA, Inc.

RaleighHub

1101 Shiloh Glenn Drive, Morrisville, NC 27560

Phone: 919-266-3671

se.com/us/en/product-category/5800-universal-enclosures/