

REVISIONS					
REV	ECO	DESCRIPTION	DATE	BY	APPR
A1	-	RELEASE NEW DRAWING	22JUN18	SULLEN	TOMMY
A2	-	UPDATE DRAWING	18MAR19	SULLEN	TOMMY

LASER ENGRAVE POLARITY, CONTACT NUMBER, VOLTAGE, SEAL TYPE, SPECIAL CIRCUIT TYPE (RVPC), AND LED COLOR CODE AS SHOWN IN THIS AREA.

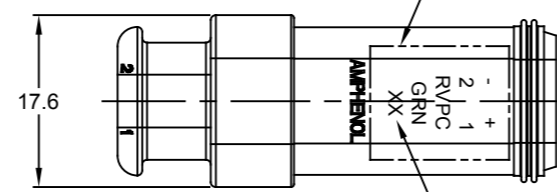

SEE PART NUMBER CHART BELOW.
XX = SEAL CODE. RD IF REDUCED DIA.,
BLANK IF STANDARD SEAL.

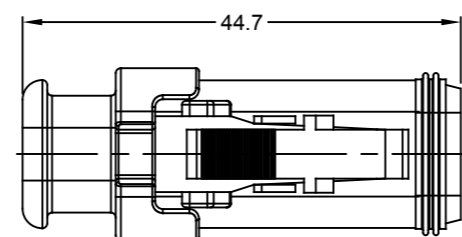
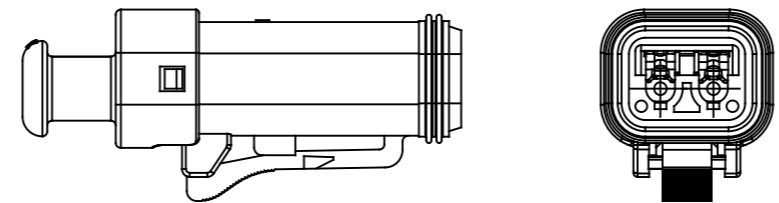

COMPONENT TYPES:
RESISTOR: TYPE 0805, R680Ω, 1/8W
SMD LED: KPA-1606ZGC-G
SMD RECTIFIER DIODE: 1000V, 1A, S1M

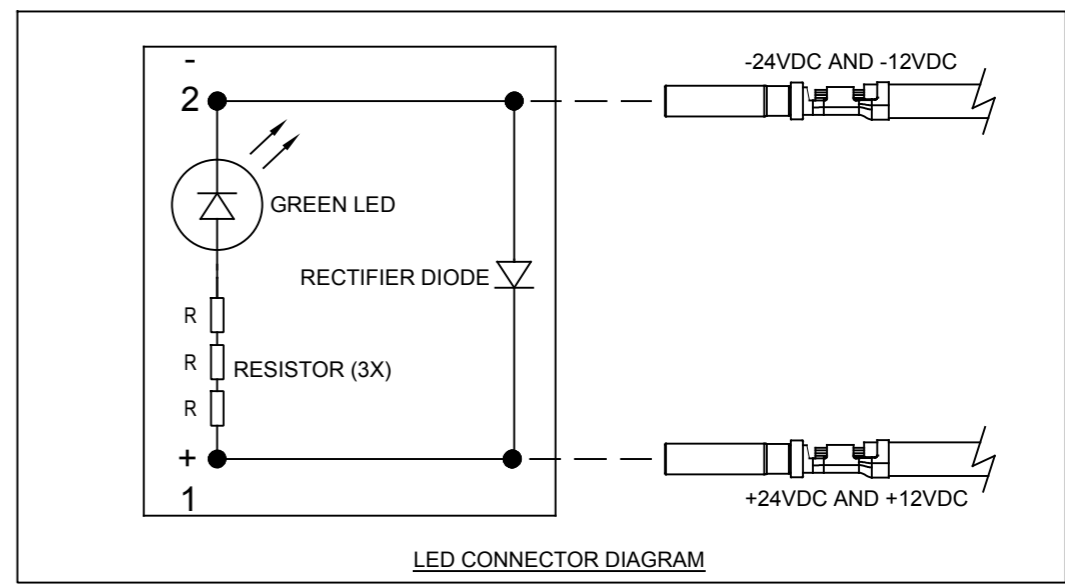
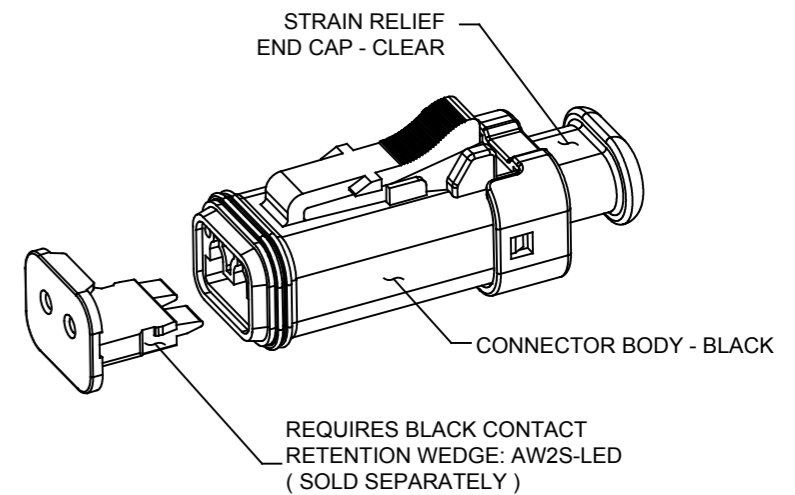

NOTES: UNLESS OTHERWISE SPECIFIED

- MATERIAL:
HOUSING: THERMOPLASTIC, BLACK
SEAL: SILICONE RUBBER
- MODIFICATIONS: LIGHT EMITTING DIODE (GREEN), STRAIN RELIEF END CAP, REVERSE VOLTAGE PROTECTION CIRCUIT (RVPC).
- CONNECTOR SPECIFICATIONS:
3.1 CURRENT RATING: 13 AMPS
3.2 DIELECTRIC WITHSTANDING VOLTAGE: LESS THAN 2 MILLIAMPS CURRENT LEAKAGE @ 1500 VOLTS AC.
3.3 INSULATION RESISTANCE: 1000 MEGOHMS MIN @ 25°C.
3.4 MOISTURE RESISTANCE: IP67 (MATED CONDITION)
3.5 MATING CYCLE DURABILITY: 100 CYCLES
3.6 ROHS COMPLIANT
- LED SPECIFICATIONS:
4.1 FORWARD CURRENT: 30 MILLIAMPS TYPICAL;
100 MILLIAMPS MAXIMUM
4.2 REVERSE CURRENT: 50 MICROAMPS MAXIMUM
4.3 POWER DISSIPATION: 120 MILLIWATTS MAXIMUM
4.4 FORWARD VOLTAGE: 4 VOLTS MAXIMUM
4.5 REVERSE VOLTAGE: 5 VOLTS MAXIMUM
- RESISTANCE SPECIFICATIONS:
5.1 RESISTANCE VALUE: 680 OHMS;
5.2 POWER RATING: 1/8 WATTS
5.3 MAX.WORKING VOLTAGE: 150 VOLTS
- RECTIFIER DIODE SPECIFICATIONS:
6.1 PEAK REVERSE VALUE: 1000 VOLTS;
6.2 FORWARD VOLTAGE: <1.1V @ I = 1A
- MATING PART: AT04-2P* RECEPTACLE
(* = MODIFICATIONS AND COLORS)
- ALL DIMENSIONS ARE FOR REFERENCE USE ONLY.

9 CONTACT SIZE AND REAR SEAL WIRE RANGE:

REDUCED DIAMETER SEAL:

CONTACT SIZE	MIN. INSUL O.D.	MAX. INSUL O.D.	TYPICAL WIRE RANGE
16	1.35 mm (.053 in)	3.05 mm (.120 in)	14 - 20 AWG

STANDARD SEAL:

CONTACT SIZE	MIN. INSUL O.D.	MAX. INSUL O.D.	TYPICAL WIRE RANGE
16	2.24 mm (.088 in)	3.68 mm (.145 in)	14 - 20 AWG



PART NUMBER CHART	
SEAL	PART NUMBER
STANDARD	AT06-2S-LED1224V
REDUCED DIAMETER	AT06-2S-LED1224VR



QUANTITY	SEE PN CHART	DESCRIPTION	ITEM
	PART NUMBER		
MATERIALS LIST			
UNLESS OTHERWISE SPECIFIED 1) All dimensions are in metric(mm). 2) Tolerances are as follows: 1 PL DEC ±0.30 2 PL DEC ±0.15 3 PL DEC ±0.08 3) Note reference =		SIGNATURES DRAWN: SULLEN,ZHANG CHECKED: ORION,LI ENGINEER: APPROVAL: TOMMY,XIE	DATE 18MAR19 18MAR19
MATERIAL SPECIFICATIONS:		 Sine Systems - www.amphenol-sine.com 44724 Morley Drive Clinton Township, MI 48036 AT SERIES, 2-WAY, PLUG, LED, 12V OR 24V CLEAR CAP, BLACK, RVP CIRCUIT	
PROCESS SPECIFICATIONS:			
NEXT ASSY:	THIS DRAWING IS SUPPLIED FOR INFORMATION ONLY. DESIGN FEATURES, SPECIFICATIONS AND PERFORMANCE DATA SHOWN HEREON ARE THE PROPERTY OF THE AMPHENOL CORPORATION. NO RIGHTS OF REPRODUCTION ARE IMPLIED. ALL DIMENSIONS ARE SUBJECT TO NORMAL MANUFACTURING VARIATIONS.		SIZE: B C- TYPE: AT06-2S-LED1224VX DWG NO: REVISION: A2
SCALE: NONE		SHEET 1 OF 1	

TITLE: AT SERIES, 2-WAY, PLUG, LED, 12V OR 24V, CLEAR CAP, BLACK, RVP CIRCUIT
DWG NO: AT06-2S-LED1224VX
REV: A2
SH: 1
OF: 1



AT Series™ - Contact Size 16 Options

Machined Contacts, Sockets & Pins				
Part Number	Description	Size	AWG	Type
AT60-215-1631	Male Contact - Pin, Gold-plated	16	14	Machined
AT62-209-1631	Female Contact - Socket, Gold-plated	16	14	Machined
AT60-215-16141	Male Contact - Pin, Nickel-plated	16	14	Machined
AT62-209-16141	Female Contact - Socket, Nickel-plated	16	14	Machined
AT60-202-1631	Male Contact - Pin, Gold-plated	16	16-20	Machined
AT62-201-1631	Female Contact - Socket, Gold-plated	16	16-20	Machined
AT60-202-16141	Male Contact - Pin, Nickel-plated	16	16-20	Machined
AT62-201-16141	Female Contact - Socket, Nickel-plated	16	16-20	Machined
AT60-202-1631-22	Male Contact - Pin, Gold-plated	16	22-24	Machined
AT62-201-1631-22	Female Contact - Socket, Gold-plated	16	22-24	Machined
AT60-202-16141-22	Male Contact - Pin, Nickel-plated	16	22-24	Machined
AT62-201-16141-22	Female Contact - Socket, Nickel-plated	16	22-24	Machined

Tooling - Machined Contacts		
Part	Part Number	Description
	CA-5D12	Universal Hand Crimp Tool, Size 12/16/20 (Machined contacts only)
	CA-5E12	Pneumatic Crimp Tool, Size 12/16/20 (Machined contacts only)

Contact Removal Tools		
Part	Part Number	Description
	ATRT-100	Used for removal of contacts for A Series™ products
	AT11-310-1605	Contact Removal Tool, Plastic, Size 16
	A114017	Sealing Plug, Size 16, White

Stamped & Formed Contacts, Sockets & Pins				
Part Number	Description	Size	AWG	Type
AT60-14-0144	Male Contact - Pin, Gold-plated	16	14-16	Stamped & Formed
AT62-14-0144	Female Contact - Socket, Gold-plated	16	14-16	Stamped & Formed
AT60-14-0122	Male Contact - Pin, Nickel-plated	16	14-16	Stamped & Formed
AT62-14-0122	Female Contact - Socket, Nickel-plated	16	14-16	Stamped & Formed
AT60-16-0144	Male Contact - Pin, Gold-plated	16	16-18	Stamped & Formed
AT62-16-0144	Female Contact - Socket, Gold-plated	16	16-18	Stamped & Formed
AT60-16-0122	Male Contact - Pin, Nickel-plated	16	16-18	Stamped & Formed
AT62-16-0122	Female Contact - Socket, Nickel-plated	16	16-18	Stamped & Formed
AT60-16-0644	Male Contact - Pin, Gold-plated	16	18-20	Stamped & Formed
AT62-16-0644	Female Contact - Socket, Gold-plated	16	18-20	Stamped & Formed
AT60-16-0622	Male Contact - Pin, Nickel-plated	16	18-20	Stamped & Formed
AT62-16-0622	Female Contact - Socket, Nickel-plated	16	18-20	Stamped & Formed
AT60-16-0844	Male Contact - Pin, Gold-plated	16	20-22	Stamped & Formed
AT62-16-0844	Female Contact - Socket, Gold-plated	16	20-22	Stamped & Formed
AT60-16-0822	Male Contact - Pin, Nickel-plated	16	20-22	Stamped & Formed
AT62-16-0822	Female Contact - Socket, Nickel-plated	16	20-22	Stamped & Formed

Tooling - Stamped & Formed Contacts		
Part	Part Number	Description
	MFX-3950	Crimp Die - Size 16, 18-20AWG (S&F contacts only)
	MFX-3953	Crimp Die - Size 16, 16-18AWG (S&F contacts only)
	MFX-3975	Crimp Die - Size 16, 14-16AWG (S&F contacts only)
	MFX-3990	Crimp Die - Size 16, 20-22AWG (S&F contacts only)
	ATT-16-00	Hand Crimp Tool - Size 16, 14-16AWG (S&F contacts only)
	ATT-16-01	Hand Crimp Tool - Size 16, 18-20AWG (S&F contacts only)
	ATT-1612-03	Hand Crimp Tool - Size 16, 20-22AWG (S&F contacts only)

Amphenol Sine Systems
 44724 Morley Drive
 Clinton Township, MI 48036 USA
www.amphenol-sine.com
 09/2021