

316455-1 ✓ ACTIVE

MATE-N-LOK | Mini-Universal MATE-N-LOK

TE Internal #: 316455-1

Cable Clamp & Body, Shell Size 9, 9 Position, Mini-Universal MATE-N-LOK

[View on TE.com >](#)



Connectors > Connector Accessories > Connector Backshells



Connector Backshell Product Type: **Cable Clamp & Body**

Compatible With Connector Shell Size: **9**

Number of Positions: **9**

Compatible With Connector Shape: **Rectangular**

Operating Temperature Range: **-20 – 105 °C [ -4 – 221 °F ]**

## Features

### Product Type Features

Connector Backshell Product Type	Cable Clamp & Body
----------------------------------	--------------------

### Configuration Features

Number of Positions	9
---------------------	---

### Housing Features

Compatible With Connector Shape	Rectangular
---------------------------------	-------------

### Usage Conditions

Operating Temperature Range	-20 – 105 °C[-4 – 221 °F]
-----------------------------	---------------------------

### Operation/Application

Compatible With Connector Shell Size	9
--------------------------------------	---

### Industry Standards

UL Flammability Rating	UL 94V-0
------------------------	----------

### Packaging Features

Packaging Quantity	500
--------------------	-----

Packaging Method	Bag
------------------	-----

## Product Compliance

[For compliance documentation, visit the product page on TE.com>](#)

EU RoHS Directive 2011/65/EU	Compliant
EU ELV Directive 2000/53/EC	Compliant
China RoHS 2 Directive MIIT Order No 32, 2016	No Restricted Materials Above Threshold
EU REACH Regulation (EC) No. 1907/2006	Current ECHA Candidate List: JUNE 2023 (235) Candidate List Declared Against: JUNE 2023 (235) Does not contain REACH SVHC
Halogen Content	Not Low Halogen - contains Br or Cl > 900 ppm.
Solder Process Capability	Not applicable for solder process capability

### Product Compliance Disclaimer

This information is provided based on reasonable inquiry of our suppliers and represents our current actual knowledge based on the information they provided. This information is subject to change. The part numbers that TE has identified as EU RoHS compliant have a maximum concentration of 0.1% by weight in homogenous materials for lead, hexavalent chromium, mercury, PBB, PBDE, DBP, BBP, DEHP, DIBP, and 0.01% for cadmium, or qualify for an exemption to these limits as defined in the Annexes of Directive 2011/65/EU (RoHS2). Finished electrical and electronic equipment products will be CE marked as required by Directive 2011/65/EU. Components may not be CE marked. Additionally, the part numbers that TE has identified as EU ELV compliant have a maximum concentration of 0.1% by weight in homogenous materials for lead, hexavalent chromium, and mercury, and 0.01% for cadmium, or qualify for an exemption to these limits as defined in the Annexes of Directive 2000/53/EC (ELV). Regarding the REACH Regulation, the information TE provides on SVHC in articles for this part number is based on the latest European Chemicals Agency (ECHA) 'Guidance on requirements for substances in articles' posted at this URL: <https://echa.europa.eu/guidance-documents/guidance-on-reach>

## Compatible Parts

 <p>TE Part # 172161-1 9 CIR UNIV M-N-L CAP</p>	 <p>TE Part # 1-172161-9 MINI UNIVERSAL M-N-L CAP 9P</p>	 <p>TE Part # 794370-1 08P MINI UMNL STR RELIEF HNGD</p>
--	--	---

Also in the Series | [Mini-Universal MATE-N-LOK](#)

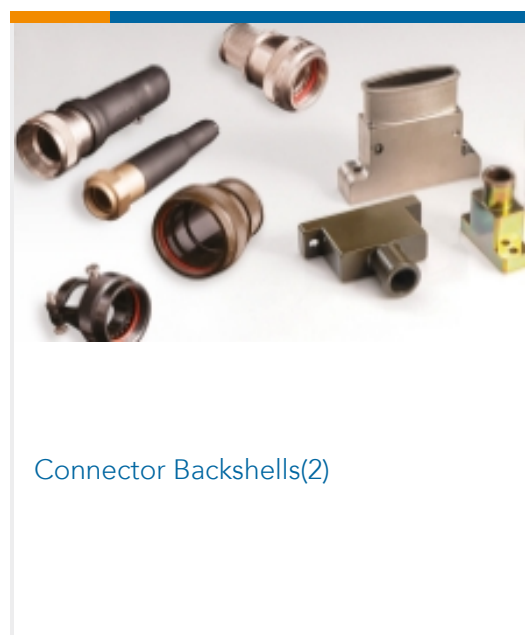

Connector Backshells(2)

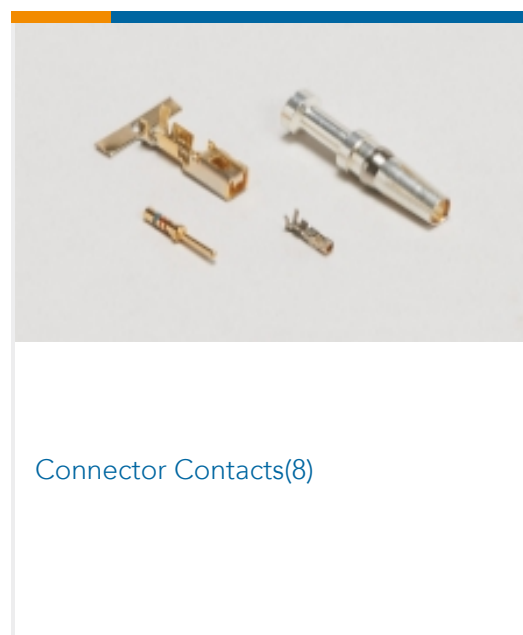

Connector Contacts(8)

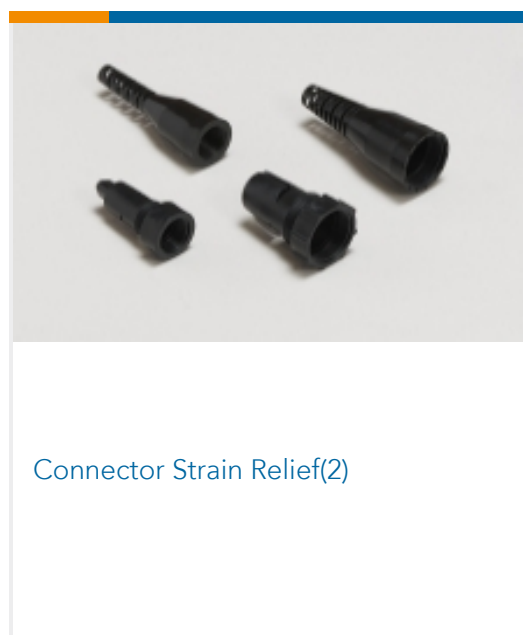

Connector Strain Relief(2)

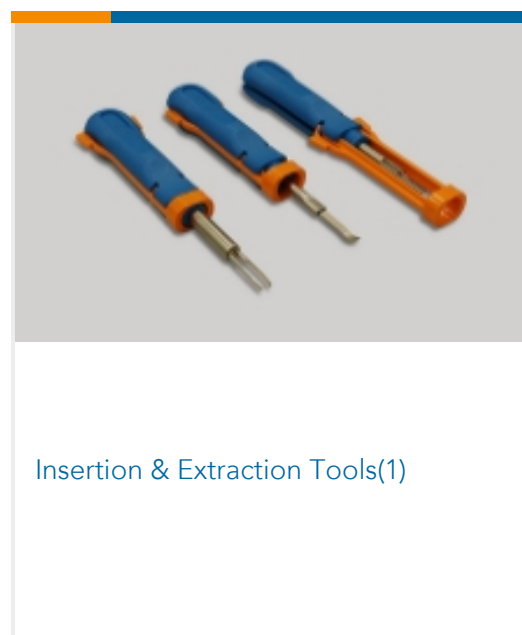

Insertion & Extraction Tools(1)



PCB Headers & Receptacles(1)

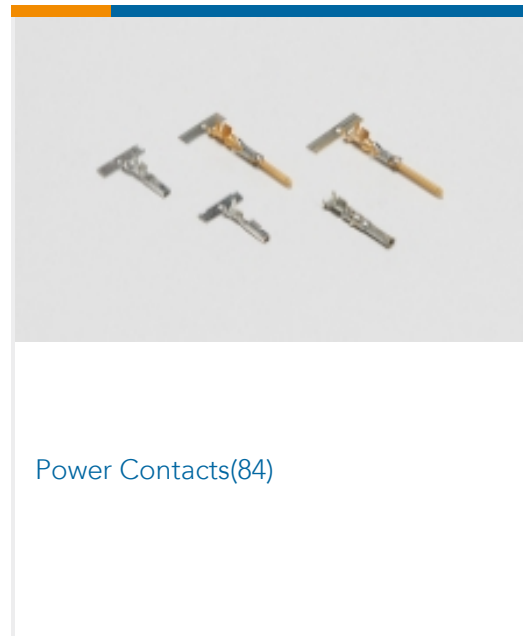

Power Contacts(84)

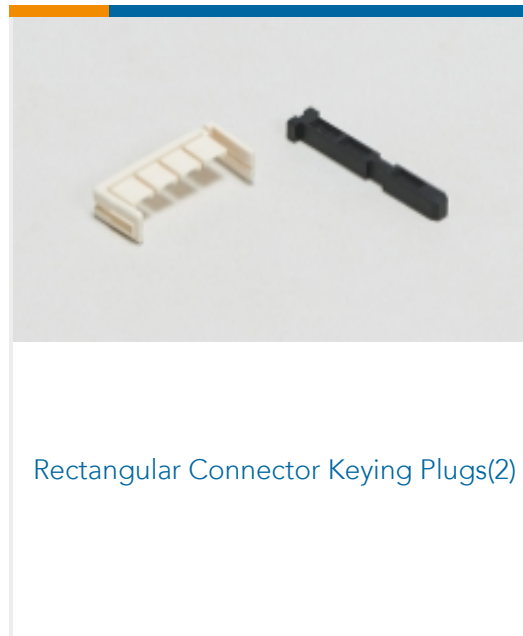

Rectangular Connector Keying Plugs(2)

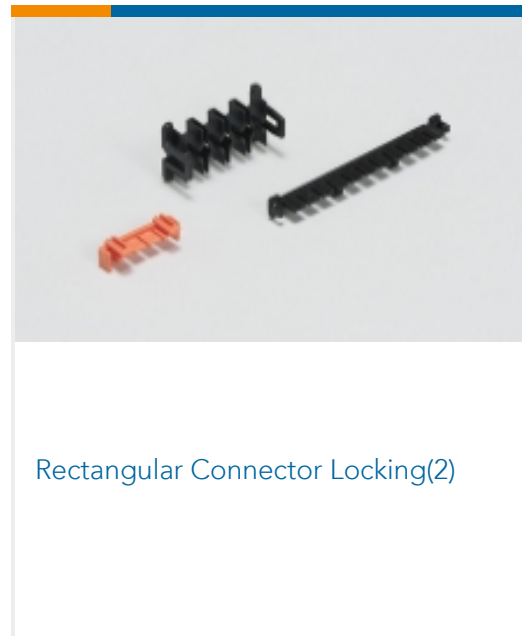

Rectangular Connector Locking(2)



Rectangular Connector Seals(17)



Rectangular Power Connectors(243)

## Customers Also Bought



TE Part #6-66505-9  
20 DF SOCKET CONT,SMALL PACK



TE Part #T4110512041-000  
M12 F, 4P GOLD D\_CODE S SHIELDED PG9



TE Part #172161-1  
9 CIR UNIV M-N-L CAP



TE Part #1-172169-9  
9 POS TR MINI UNIV



TE Part #T4112012081-000  
M12 F, 8P GOLD A\_CODE RA SHIELDED PG9



TE Part #206705-4  
CPC RECPT ASSEMBLY SIZE 13-9

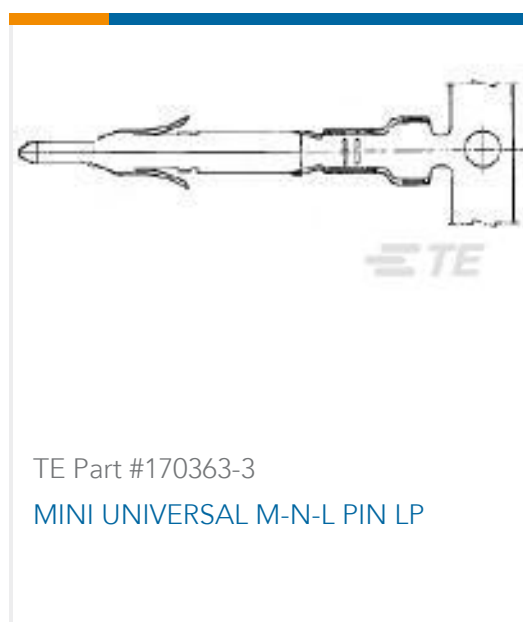

TE Part #170363-3  
MINI UNIVERSAL M-N-L PIN LP



TE Part #2151119-1  
OCEAN\_2.0\_APPLICATOR-S-100F110F



## Documents

### CAD Files

[3D PDF](#)

[3D](#)

**Customer View Model**

[ENG\\_CVM\\_CVM\\_316455-1\\_A\\_c-316455-1-a.2d\\_dxf.zip](#)

English

**Customer View Model**

[ENG\\_CVM\\_CVM\\_316455-1\\_A\\_c-316455-1-a.3d\\_igs.zip](#)

English

**Customer View Model**

[ENG\\_CVM\\_CVM\\_316455-1\\_A\\_c-316455-1-a.3d\\_stp.zip](#)

English

By downloading the CAD file I accept and agree to the [Terms and Conditions](#) of use.

### Datasheets & Catalog Pages

[SOFT\\_SHELL\\_PIN\\_AND\\_SOCKET\\_CONNECTORS\\_CATALOG](#)

English

### Product Specifications

[Application Specification](#)

English

### Product Environmental Compliance

[TE Material Declaration](#)

English