

SM4NT22(C)A THRU SM4NT440(C)A

List

List..... 1

Package outline..... 2

Features..... 2

Mechanical data..... 2

Maximum ratings 2

Electrical characteristics 3

Rating and characteristic curves..... 4~5

Pinning information..... 6

Marking..... 6

Suggested solder pad layout..... 6

Packing information..... 7

Reel packing..... 8

Suggested thermal profiles for soldering processes..... 8

High reliability test capabilities..... 9

SM4NT22(C)A THRU SM4NT440(C)A

400W Dual Flat No-Lead Unidirectional and Bidirectional Transient Voltage Suppressors 22V-440V

Features

- Well package design with solder pad on the bottom for best thermal performance
- Leads on two opposing sides of the body
- Tiny plastic DFN package
- 400W peak pulse power capability with a 10/1000 μ s waveform, repetition rate (duty cycle): 0.01%
- Uni and Bidirectional unit
- Glass passivated chip junction
- Excellent clamping capability
- Low incremental surge resistance
- Lead-free parts meet RoHS requirements
- Suffix "-H" indicates Halogen-free part, ex. SM4NT22A-H

Mechanical data

- Epoxy: UL94-V0 rated flame retardant
- Case : Molded plastic, SOD-123NT
- Terminals : Solder plated, solderable per MIL-STD-750, Method 2026
- Polarity : Indicated by cathode band(Uni-directional types only)
- Mounting Position : Any
- Weight : Approximated 0.022 gram

Package outline

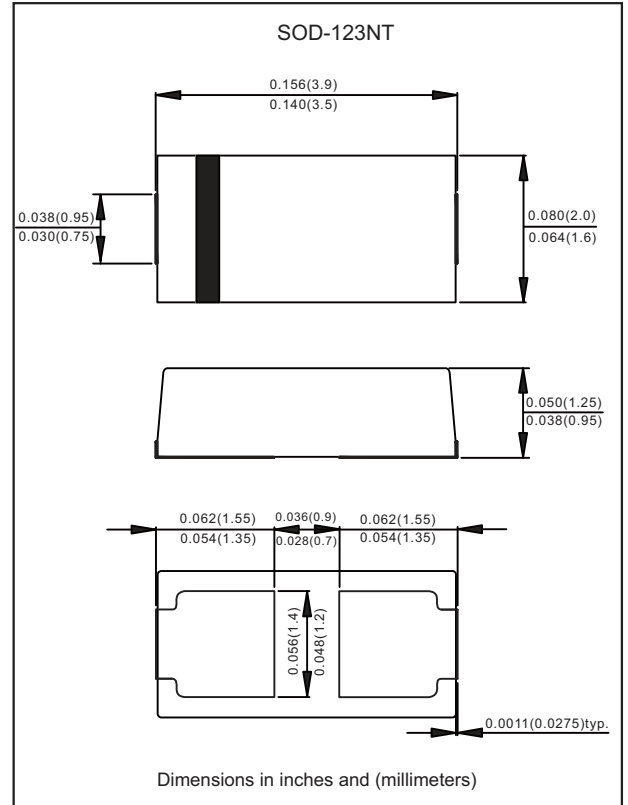
Maximum ratings (AT $T_A=25^\circ\text{C}$ unless otherwise noted)

Parameter	Conditions	Symbol	Value	Unit
Peak power dissipation	with a 10/1000 μ s waveform, Note 1, 2 & Fig. 1	PPPM	400	W
Peak pulse current	with a 10/1000 μ s waveform	IPPM	See Table	A
Steady state power dissipation	at $T_L=75^\circ\text{C}$, Note 2	$P_{M(AV)}$	1.0	W
Operating junction temperature range		T_J	-55 to +150	$^\circ\text{C}$
Storage temperature range		T_{STG}	-65 to +175	$^\circ\text{C}$

Notes 1: Non-repetitive current pulse, per Fig. 3 and derated above $T_A=25^\circ\text{C}$ per Fig. 2
 2: Mounted on copper pad area of 0.2"x0.2" (5.0x5.0 mm) per Fig 5

Electrical characteristics (at $T_A=25^\circ\text{C}$ unless otherwise noted)

Part No. (Uni)	Part No. (Bi)	Reverse Stand-off Voltage	Breakdown Voltage @ I_T		Test Current	Maximum Clamping Voltage @ I_{PP}		Maximum Reverse Leakage Current	Marking Code	
		V_{RWM}	V_{BRMin}	V_{BRMax}	I_T	V_C	I_{PP}	$I_R@V_{RWM}$	Uni	Bi
		Volts	Volts	Volts	mA	Volts	A	μA		
SM4NT22A	SM4NT22CA	22	24.4	26.9	1.0	35.5	11.27	5	4LX	4BX
SM4NT24A	SM4NT24CA	24	26.7	29.5	1.0	38.9	10.29	5	4LZ	4BZ
SM4NT26A	SM4NT26CA	26	28.9	31.9	1.0	42.1	9.51	5	4ME	4CE
SM4NT28A	SM4NT28CA	28	31.1	34.4	1.0	45.4	8.82	5	4MG	4CG
SM4NT30A	SM4NT30CA	30	33.3	36.8	1.0	48.4	8.27	5	4MK	4CK
SM4NT33A	SM4NT33CA	33	36.7	40.6	1.0	53.3	7.51	5	4MM	4CM
SM4NT36A	SM4NT36CA	36	40.0	44.2	1.0	58.1	6.89	5	4MP	4CP
SM4NT40A	SM4NT40CA	40	44.4	49.1	1.0	64.5	6.21	5	4MR	4CR
SM4NT43A	SM4NT43CA	43	47.8	52.8	1.0	69.4	5.77	5	4MT	4CT
SM4NT45A	SM4NT45CA	45	50.0	55.3	1.0	72.7	5.51	5	4MV	4CV
SM4NT48A	SM4NT48CA	48	53.3	58.9	1.0	77.4	5.17	5	4MX	4CX
SM4NT51A	SM4NT51CA	51	56.7	62.7	1.0	82.4	4.86	5	4MZ	4CZ
SM4NT54A	SM4NT54CA	54	60.0	66.3	1.0	87.1	4.60	5	4NE	4DE
SM4NT58A	SM4NT58CA	58	64.4	71.2	1.0	93.6	4.28	5	4NG	4DG
SM4NT60A	SM4NT60CA	60	66.7	73.7	1.0	96.8	4.14	5	4NK	4DK
SM4NT64A	SM4NT64CA	64	71.1	78.6	1.0	103	3.89	5	4NM	4DM
SM4NT70A	SM4NT70CA	70	77.8	86.0	1.0	113	3.54	5	4NP	4DP
SM4NT75A	SM4NT75CA	75	83.3	92.1	1.0	121	3.31	5	4NR	4DR
SM4NT78A	SM4NT78CA	78	86.7	95.8	1.0	126	3.18	5	4NT	4DT
SM4NT85A	SM4NT85CA	85	94.4	104	1.0	137	2.92	5	4NV	4DV
SM4NT90A	SM4NT90CA	90	100	111	1.0	146	2.74	5	4NX	4DX
SM4NT100A	SM4NT100CA	100	111	123	1.0	162	2.47	5	4NZ	4DZ
SM4NT110A	SM4NT110CA	110	122	135	1.0	177	2.26	5	4PE	4EE
SM4NT120A	SM4NT120CA	120	133	147	1.0	193	2.08	5	4PG	4EG
SM4NT130A	SM4NT130CA	130	144	159	1.0	209	1.92	5	4PK	4EK
SM4NT150A	SM4NT150CA	150	167	185	1.0	243	1.65	5	4PM	4EM
SM4NT160A	SM4NT160CA	160	178	197	1.0	259	1.55	5	4PP	4EP
SM4NT170A	SM4NT170CA	170	189	209	1.0	275	1.46	5	4PR	4ER
SM4NT180A	SM4NT180CA	180	201	222	1.0	292	1.37	5	4PT	4ET
SM4NT200A	SM4NT200CA	200	224	247	1.0	324	1.24	5	4PV	4EV
SM4NT220A	SM4NT220CA	220	246	272	1.0	356	1.13	5	4PX	4EX
SM4NT240A	SM4NT240CA	240	269	296	1.0	387	1.04	5	4PY	4EY
SM4NT250A	SM4NT250CA	250	279	309	1.0	405	0.99	5	4PZ	4EZ
SM4NT300A	SM4NT300CA	300	335	371	1.0	486	0.83	5	4QE	4FE
SM4NT330A	SM4NT330CA	330	369	408	1.0	534	0.75	5	4QF	4FF
SM4NT350A	SM4NT350CA	350	391	432	1.0	567	0.71	5	4QG	4FG
SM4NT360A	SM4NT360CA	360	403	444	1.0	582	0.69	5	4QH	4FH
SM4NT400A	SM4NT400CA	400	447	494	1.0	648	0.62	5	4QK	4FK
SM4NT440A	SM4NT440CA	440	492	544	1.0	713	0.57	5	4QM	4FM

Notes 1: Suffix 'C' denotes bi-directional devices. Suffix 'A' denotes 5% tolerance devices

2: Transient Voltage Suppressors (TVS) are devices used to protect vulnerable circuits from electrical overstress such as that caused by electrostatic discharge, inductive load switching and induced lightning. Within the TVS, damaging voltage spikes are limited by clamping or avalanche action of a rugged silicon pn junction which reduces the amplitude of the transient to a nondestructive level. See Fig. 6 & Fig. 7

Rating and characteristic curves

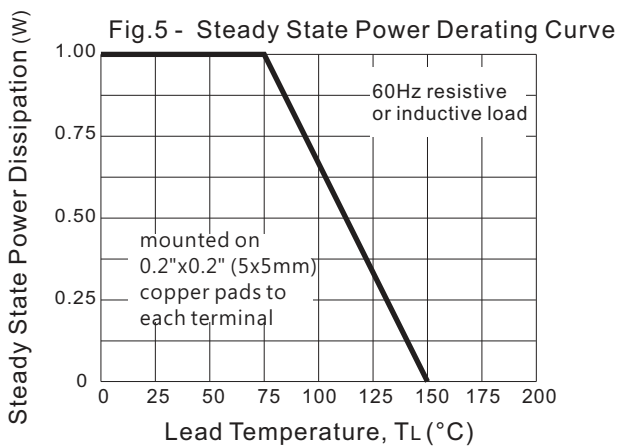
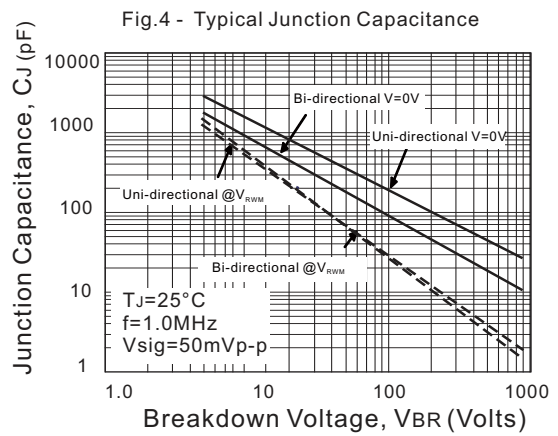
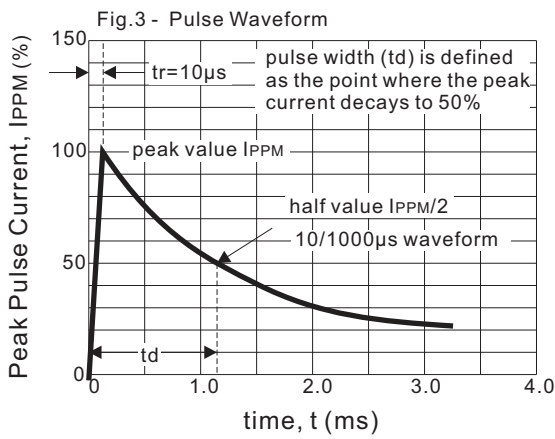
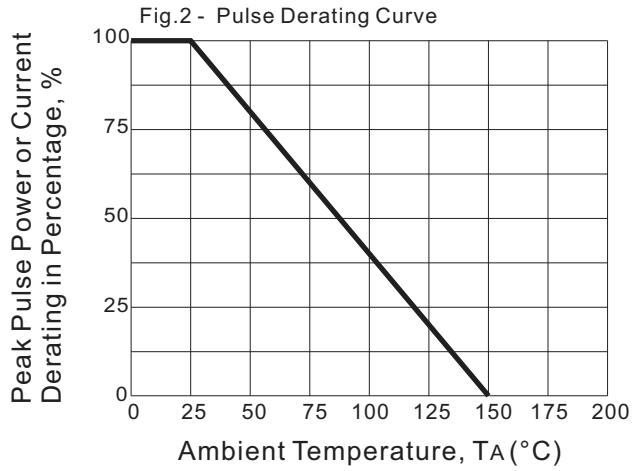
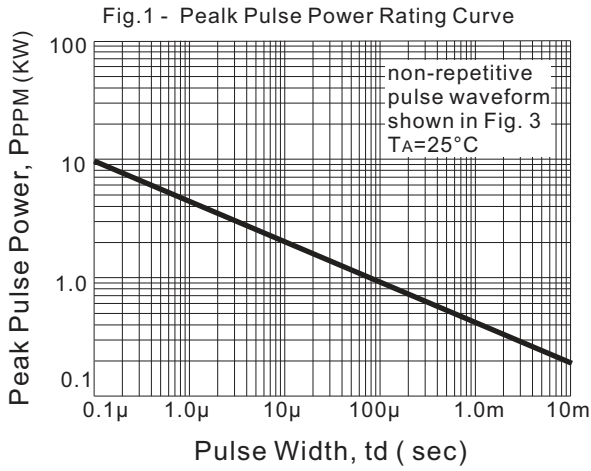

Rating and characteristic curves

Fig. 6 - Transients of several thousand volts can be clamped to a safe level by the TVS

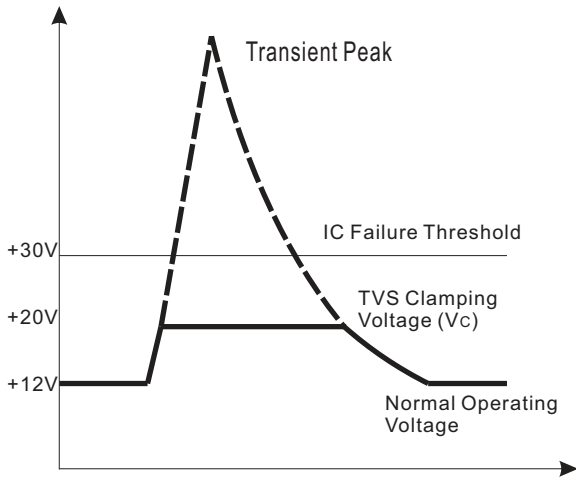
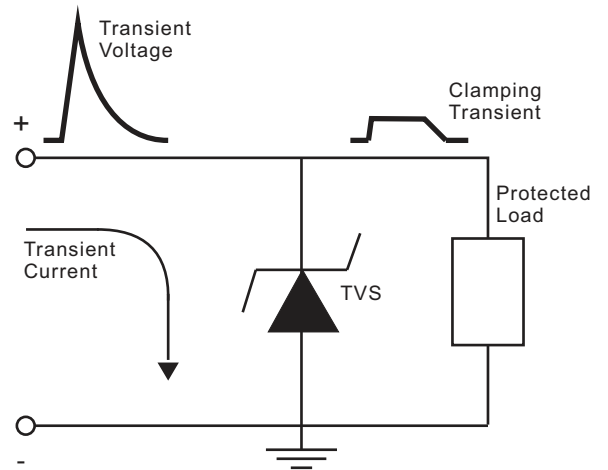





Fig. 7 - Transient current is diverted to ground thru TVS; the voltage seen by the protected load is limited to the clamping voltage level



SM4NT22(C)A THRU SM4NT440(C)A

Pinning information

Pin	Simplified outline	Symbol
Uni-Directional Pin1 cathode Pin2 anode		
Bi-Directional		

Marking

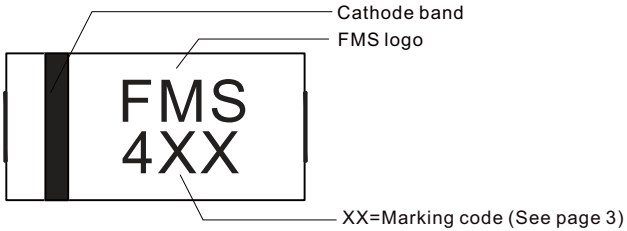
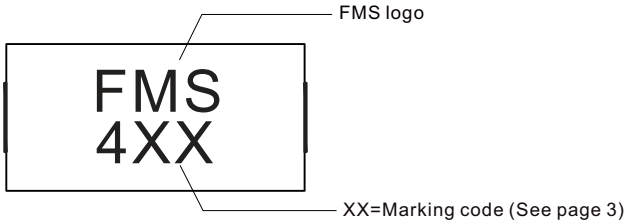
Type number	Example
Uni-Directional	 <p>Cathode band FMS logo XX=Marking code (See page 3)</p>
Bi-Directional	 <p>FMS logo XX=Marking code (See page 3)</p>

Suggested solder pad layout

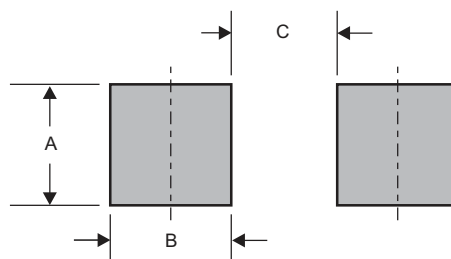

Dimensions in inches and (millimeters)

PACKAGE	A	B	C
SOD-123NT	0.056 (1.40)	0.062(1.55)	0.028 (0.70)

SM4NT22(C)A THRU SM4NT440(C)A

Packing information

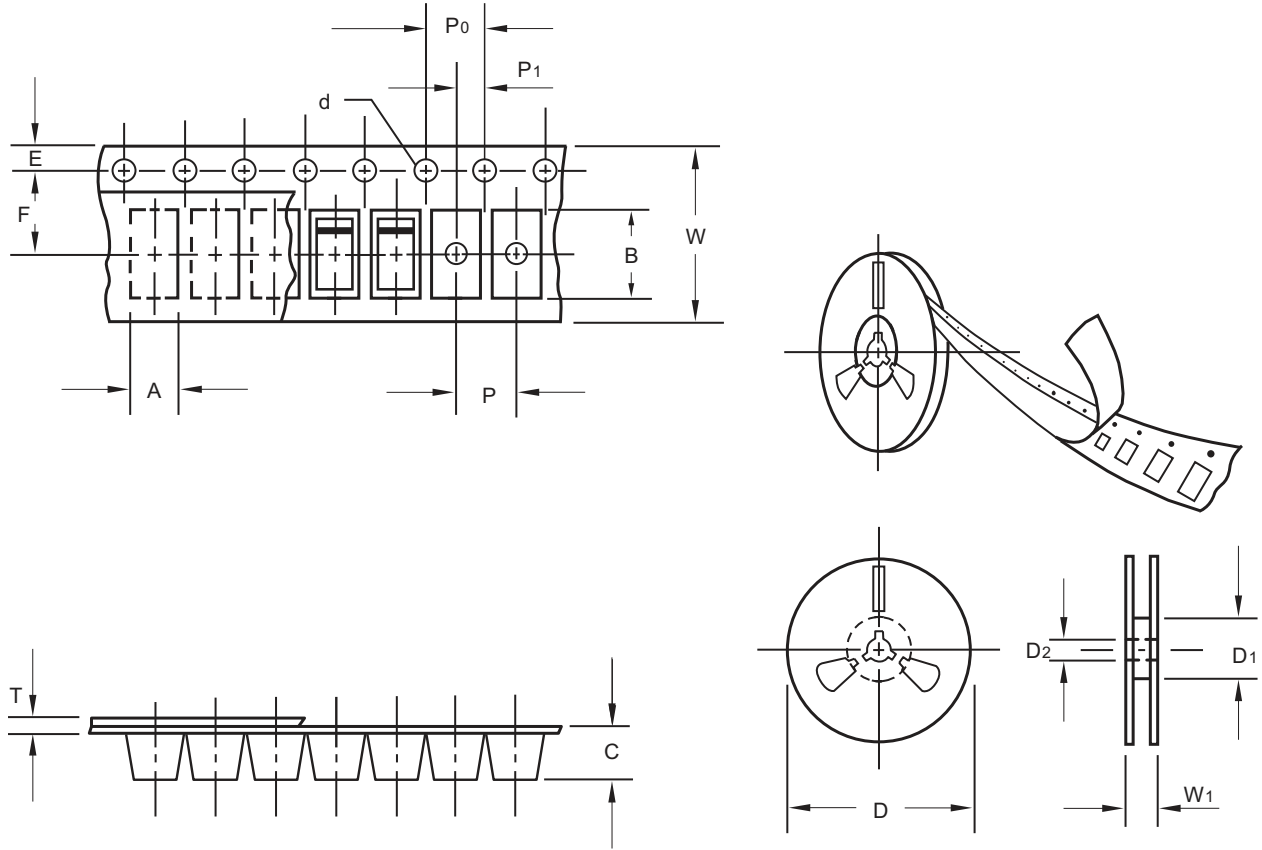

unit:mm

Item	Symbol	Tolerance	SOD-123NT
Carrier width	A	0.1	2.00
Carrier length	B	0.1	3.85
Carrier depth	C	0.1	1.10
Sprocket hole	d	0.1	1.50
13" Reel outside diameter	D	2.0	-
13" Reel inner diameter	D1	min	-
7" Reel outside diameter	D	2.0	178.00
7" Reel inner diameter	D1	min	62.00
Feed hole diameter	D2	0.5	13.00
Sprocket hole position	E	0.1	1.75
Punch hole position	F	0.1	3.50
Punch hole pitch	P	0.1	4.00
Sprocket hole pitch	P0	0.1	4.00
Embossment center	P1	0.1	2.00
Overall tape thickness	T	0.1	0.23
Tape width	W	0.3	8.00
Reel width	W1	1.0	11.40

Note: Devices are packed in accordance with EIA standard RS-481-A and specifications listed above.

SM4NT22(C)A THRU SM4NT440(C)A

Reel packing

PACKAGE	REEL SIZE	REEL (pcs)	COMPONENT SPACING (m/m)	BOX (pcs)	INNER BOX (m/m)	REEL DIA, (m/m)	CARTON SIZE (m/m)	CARTON (pcs)	APPROX. GROSS WEIGHT (kg)
SOD-123NT	7"	3,000	4.0	30,000	183*123*183	178	382*257*387	240,000	9.5

Suggested thermal profiles for soldering processes

- 1.Storage environment: Temperature=5°C~40°C Humidity=55%±25%
- 2.Reflow soldering of surface-mount devices

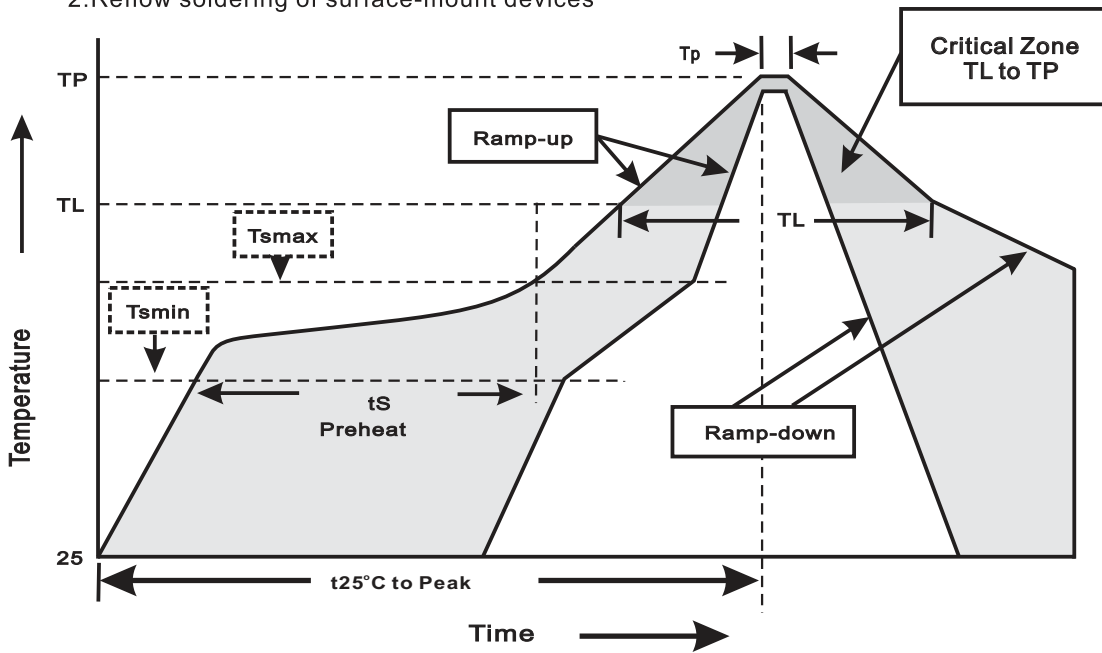

3.Reflow soldering

Profile Feature	Soldering Condition
Average ramp-up rate(TL to TP)	<3°C/sec
Preheat -Temperature Min(Tsmin) -Temperature Max(Tsmax) -Time(min to max)(ts)	150°C 200°C 60~120sec
Tsmax to TL -Ramp-upRate	<3°C/sec
Time maintained above: -Temperature(TL) -Time(tL)	217°C 60~260sec
Peak Temperature(TP)	255°C-0/+5°C
Time within 5°C of actual Peak Temperature(tp)	10~30sec
Ramp-down Rate	<3°C/sec
Time 25°C to Peak Temperature	<6minutes

SM4NT22(C)A THRU SM4NT440(C)A

High reliability test capabilities

Item Test	Conditions	Reference
1. Solder Resistance	at 260±5°C for 10±2sec.	MIL-STD-750D METHOD-2031
2. Solderability	at 245±5°C for 5 sec.	MIL-STD-202F METHOD-208
3. High Temperature Reverse Bias	$V_{BR}=V_{BR} N_{OM} * 80\%$ at $T_J=150^\circ\text{C}$ for 168 hrs.	MIL-STD-750D METHOD-1038
4. Pressure Cooker	15P _{SIG} at $T_A=121^\circ\text{C}$ for 4 hrs.	JESD22-A102
5. Temperature Cycling	-55°C to +125°C dwelled for 30 min. and transferred for 5min. total 10 cycles.	MIL-STD-750D METHOD-1051
6. Humidity	at $T_A=85^\circ\text{C}$, RH=85% for 1000hrs.	MIL-STD-750D METHOD-1021
7. High Temperature Storage Life	at 175°C for 1000 hrs.	MIL-STD-750D METHOD-1031