

# NCP336, NCP337

## Controlled Load Switch with Auto-Discharge Path, 3 A

### Description

The NCP336 and NCP337 are very low  $R_{on}$  MOSFET controlled by external logic pin, allowing optimization of battery life, and portable device autonomy.

Indeed, thanks to a current consumption optimization with PMOS structure, leakage currents are eliminated by isolating connected IC on the battery when not used.

Output discharge path is also embedded to eliminate residual voltages on the output rail for the NCP337 part only.

Proposed in a wide input voltage range from 1.2 V to 5.5 V, in a small 1 x 1.5 mm WLCSP6, pitch 0.5 mm.

### Features

- 1.2 V – 5.5 V Operating Range
- 21 m $\Omega$  P MOSFET at 4.5 V
- DC Current up to 3 A
- Output Auto-Discharge
- Active High EN Pin
- WLCSP6 1 x 1.5 mm
- This Device is Pb-Free, Halogen Free/BFR Free and is RoHS Compliant

### Applications

- Mobile Phones
- Tablets
- Digital Cameras
- GPS
- Portable Devices



ON Semiconductor®

<http://onsemi.com>



WLCSP6  
FC SUFFIX  
CASE 567FH

### PIN CONNECTIONS

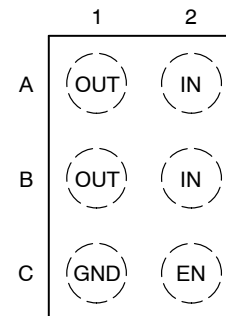

(Top View)

### ORDERING INFORMATION

See detailed ordering and shipping information on page 8 of this data sheet.

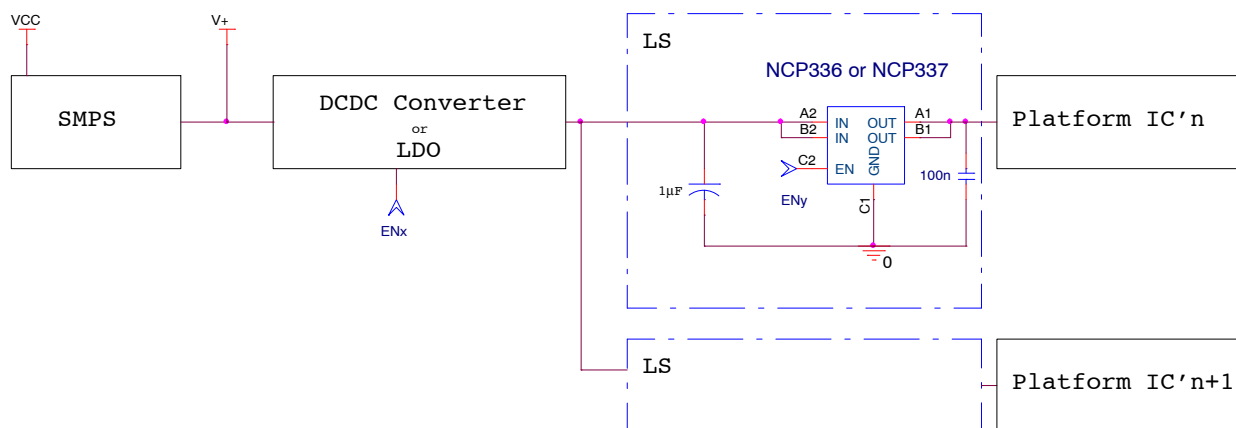
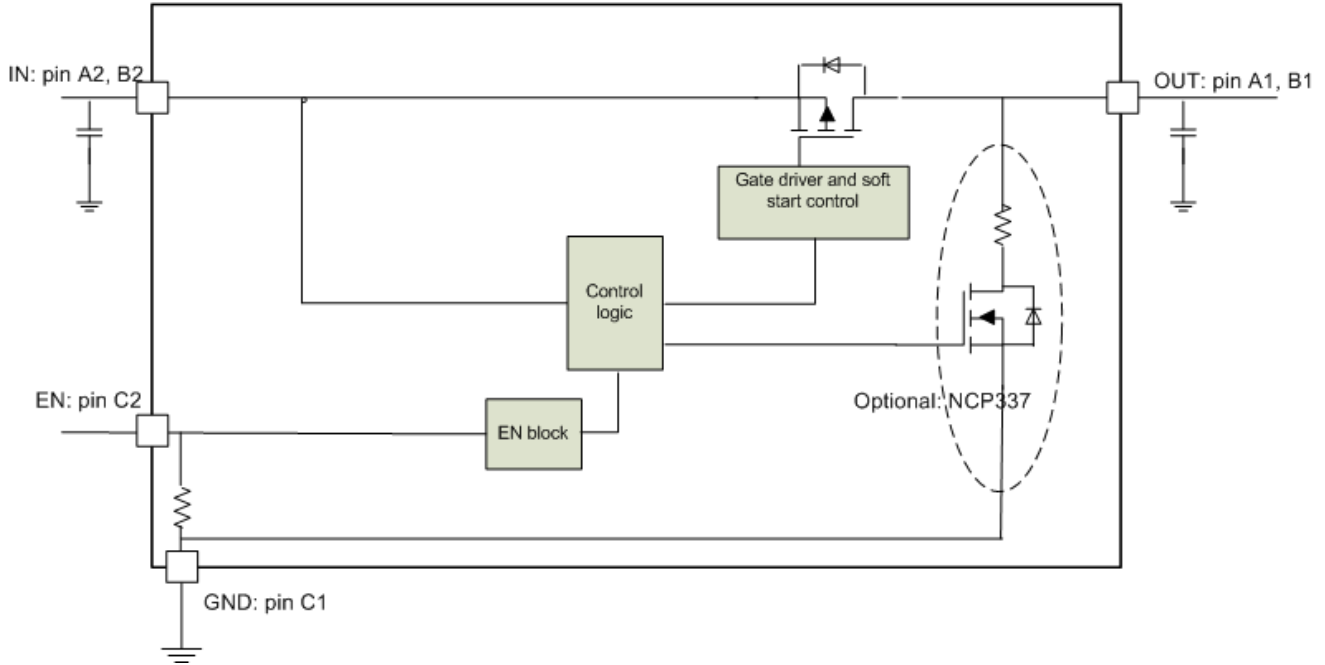

Figure 1. Typical Application Circuit

# NCP336, NCP337

**Table 1. PIN FUNCTION DESCRIPTION**

Pin Name	Pin Number	Type	Description
IN	A2, B2	POWER	Load-switch input voltage; connect a 1 $\mu$ F or greater ceramic capacitor from IN to GND as close as possible to the IC.
GND	C1	POWER	Ground connection.
EN	C2	INPUT	Enable input, logic high turns on power switch.
OUT	A1, B1	OUTPUT	Load-switch output; connect a 1 $\mu$ F ceramic capacitor from OUT to GND as close as possible to the IC is recommended.



**Figure 2. Block Diagram**

# NCP336, NCP337

**Table 2. MAXIMUM RATINGS**

Rating	Symbol	Value	Unit
IN, OUT, EN, Pins: (Note 1)	$V_{EN}, V_{IN}, V_{OUT}$	-0.3 to + 7.0	V
From IN to OUT Pins: Input/Output (Note 1)	$V_{IN}, V_{OUT}$	0 to + 7.0	V
Maximum Junction Temperature	$T_J$	-40 to + 125	°C
Storage Temperature Range	$T_{STG}$	-40 to + 150	°C
Moisture Sensitivity (Note 2)	MSL	Level 1	

Stresses exceeding Maximum Ratings may damage the device. Maximum Ratings are stress ratings only. Functional operation above the Recommended Operating Conditions is not implied. Extended exposure to stresses above the Recommended Operating Conditions may affect device reliability.

**Table 3. OPERATING CONDITIONS**

Symbol	Parameter	Conditions	Min	Typ	Max	Unit	
$V_{IN}$	Operational Power Supply		1.2		5.5	V	
$V_{EN}$	Enable Voltage		0		5.5		
$T_A$	Ambient Temperature Range		-40	25	+85	°C	
$T_J$	Junction Temperature Range		-40	25	+125	°C	
$C_{IN}$	Decoupling input capacitor		1			μF	
$C_{OUT}$	Decoupling output capacitor		1			μF	
$R_{\theta JA}$	Thermal Resistance Junction to Air	WLCSP package (Note 3)		100		°C/W	
$I_{OUT}$	Maximum DC current				3	A	
$P_D$	Power Dissipation Rating (Note 4)	$T_A \leq 25^\circ\text{C}$	WLCSP package		0.66		W
		$T_A = 85^\circ\text{C}$	WLCSP package		0.26		W

1. According to JEDEC standard JESD22-A108.
2. Moisture Sensitivity Level (MSL): 1 per IPC/JEDEC standard: J-STD-020.
3. The  $R_{\theta JA}$  is dependent of the PCB heat dissipation and thermal via.
4. The maximum power dissipation ( $P_D$ ) is given by the following formula:

$$P_D = \frac{T_{JMAX} - T_A}{R_{\theta JA}}$$

# NCP336, NCP337

**Table 4. ELECTRICAL CHARACTERISTIC** Min & Max Limits apply for  $T_A$  between  $-40^{\circ}\text{C}$  to  $+85^{\circ}\text{C}$  for  $V_{IN}$  between 1.2 V to 5.5 V (Unless otherwise noted). Typical values are referenced to  $T_A = +25^{\circ}\text{C}$  and  $V_{IN} = 5\text{ V}$  (Unless otherwise noted).

Symbol	Parameter	Conditions		Min	Typ	Max	Unit
<b>POWER SWITCH</b>							
$R_{DSON}$	Static drain-source on-state resistance	$V_{in} = 5.5\text{ V}$	$I = 1\text{ A}$ (Note 5)		20	22	$\text{m}\Omega$
		$V_{in} = 4.5\text{ V}$	$I = 500\text{ mA}$ (Note 5)		21	25	
		$V_{in} = 3.3\text{ V}$	$I = 500\text{ mA}$ (Note 5)		23	28	
		$V_{in} = 2.5\text{ V}$	$I = 500\text{ mA}$ (Note 5)		28	35	
		$V_{in} = 1.8\text{ V}$	$I = 250\text{ mA}$ (Note 5)		40	45	
		$V_{in} = 1.2\text{ V}$	$T_A = 25^{\circ}\text{C}$ , $I = 200\text{ mA}$		95	120	
$R_{dis}$	Output discharge path	$EN = \text{low}$			70	90	$\Omega$
$V_{IH}$	High-level input voltage			0.9			V
$V_{IL}$	Low-level input voltage					0.5	
$R_{pd}$	EN pull down resistor				5		$\text{M}\Omega$

### QUIESCENT CURRENT

$I_{std}$	Standby current	$V_{in} = 4.2\text{ V}$	$EN = \text{low}$ , No load			1	$\mu\text{A}$
$I_q$	Quiescent current	$V_{in} = 4.2\text{ V}$	$EN = \text{high}$ , No load			1	$\mu\text{A}$

### TIMINGS

$T_{EN}$	Enable time	$V_{in} = 3.6\text{ V}$ (Note 6)	$R_L = 25\ \Omega$ , $C_{out} = 1\ \mu\text{F}$		323		$\mu\text{s}$
$T_R$	Output rise time		$R_L = 25\ \Omega$ , $C_{out} = 1\ \mu\text{F}$		810		
$T_{ON}$	ON time ( $T_{EN} + T_R$ )		$R_L = 25\ \Omega$ , $C_{out} = 1\ \mu\text{F}$		1130		
$T_F$	Output fall time		NCP337. $R_L = 25\ \Omega$ , $C_{out} = 1\ \mu\text{F}$		42		

5. Guaranteed by design and characterization

6. Parameters are guaranteed for  $C_{LOAD}$  and  $R_{LOAD}$  connected to the OUT pin with respect to the ground

### TIMINGS

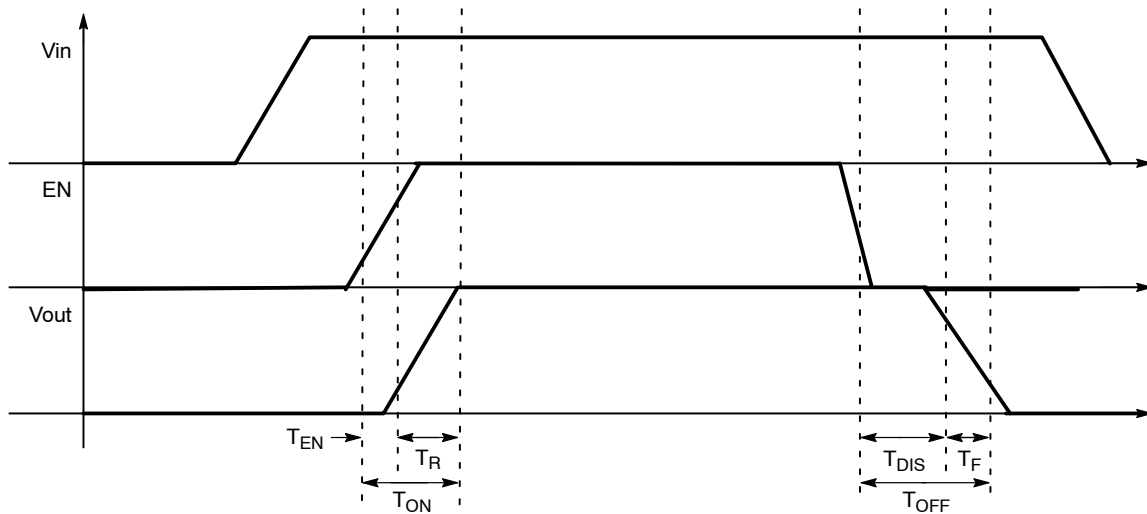

**Figure 3. Enable, Rise and Fall Time**

TYPICAL CHARACTERISTICS

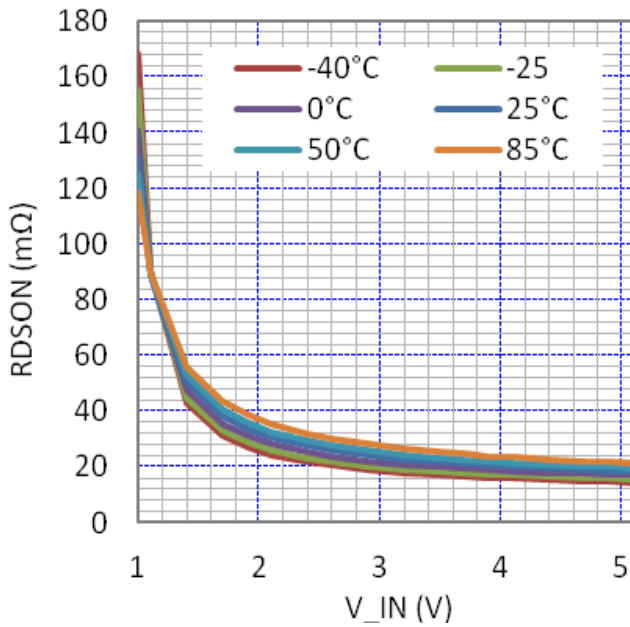

Figure 4. Rdson (mΩ) vs. Vin (V)

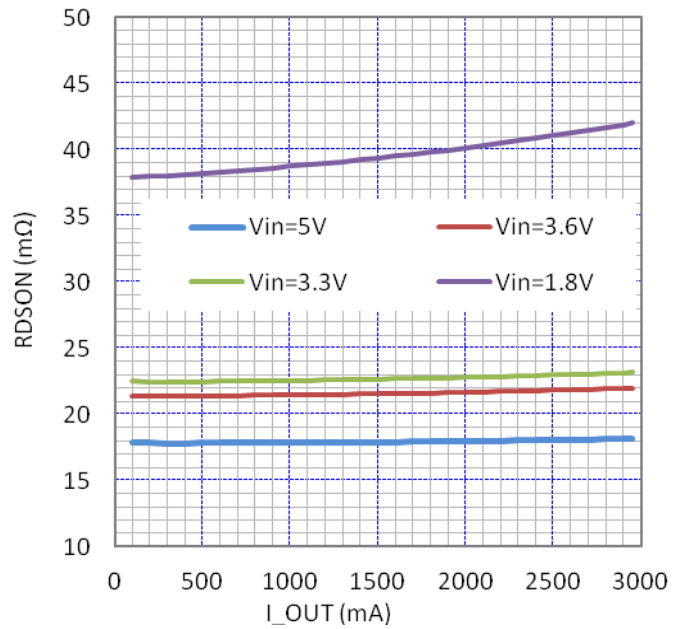

Figure 5. Rdson (mΩ) vs. Iload (A)

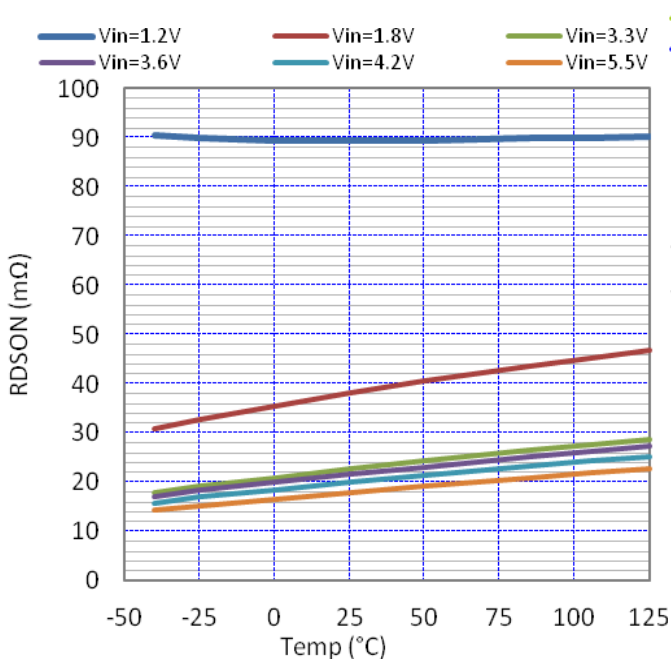

Figure 6. Rdson (mΩ) vs. Temperature (°C) at 100 mA

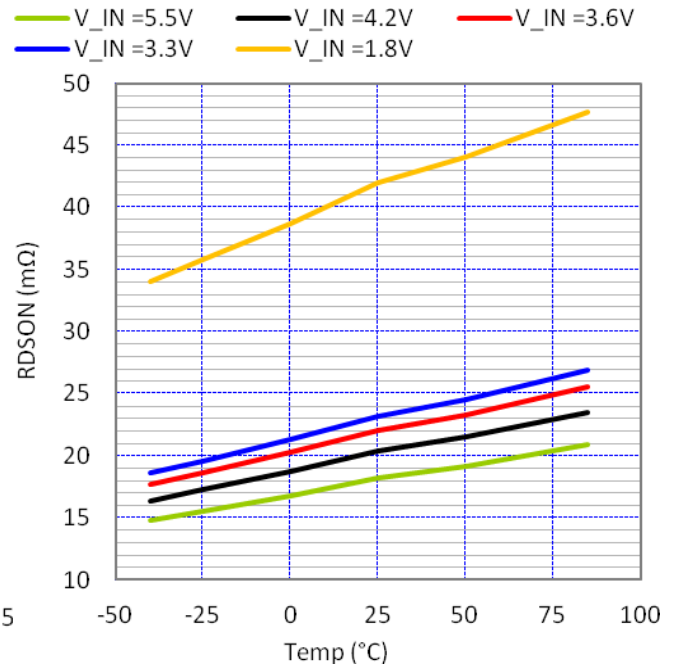

Figure 7. Rdson (mΩ) vs. Temperature (°C) at 3 A

TYPICAL CHARACTERISTICS

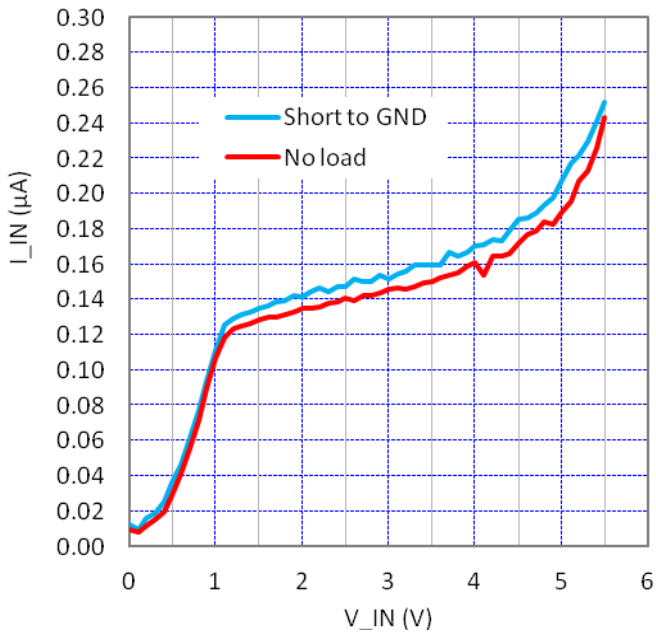

Figure 8. Standby ( $\mu\text{A}$ ) and Leakage Current ( $\mu\text{A}$ ) vs.  $V_{\text{in}}$  (V)

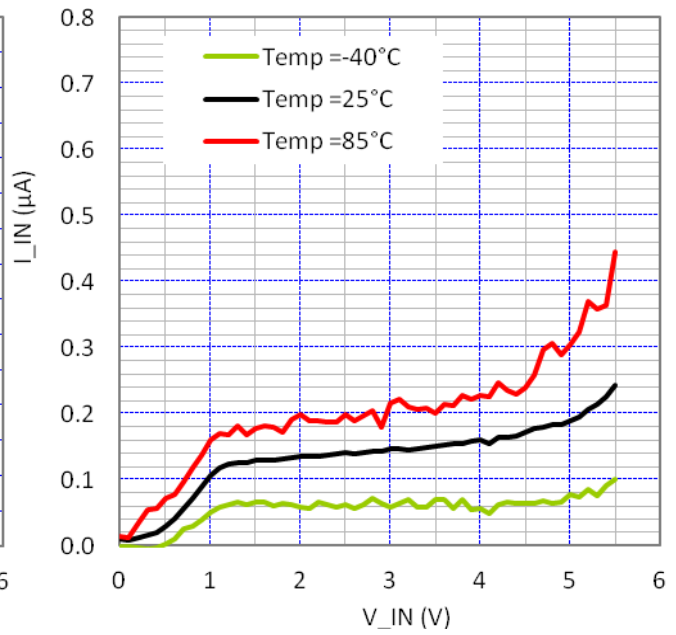

Figure 9. Standby Current ( $\mu\text{A}$ ) vs. Temperature ( $^{\circ}\text{C}$ )

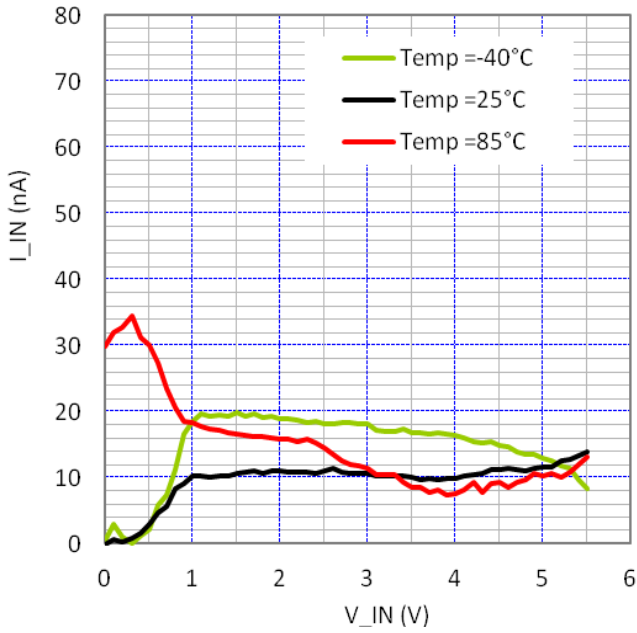

Figure 10. Leakage Current ( $\mu\text{A}$ ) vs. Temperature ( $^{\circ}\text{C}$ )

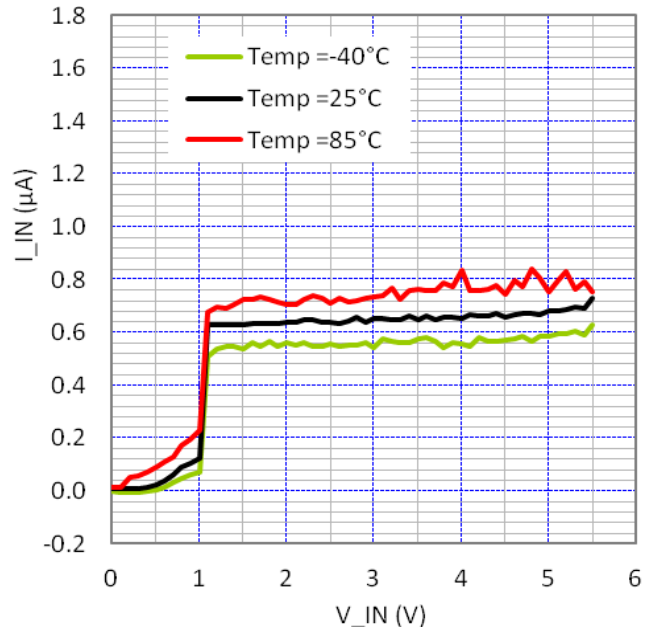

Figure 11. Quiescent Current ( $\mu\text{A}$ ) vs. Temperature ( $^{\circ}\text{C}$ )

# NCP336, NCP337

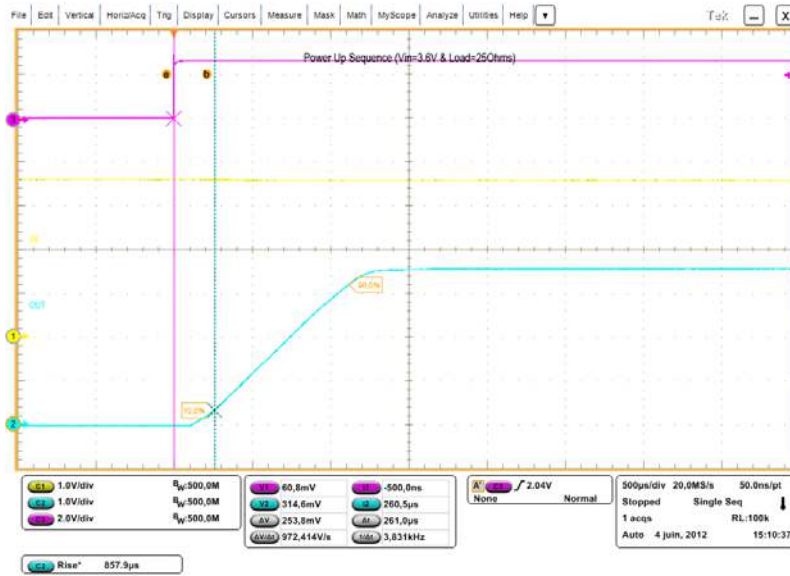

Figure 12. Enable Time and Rise Time

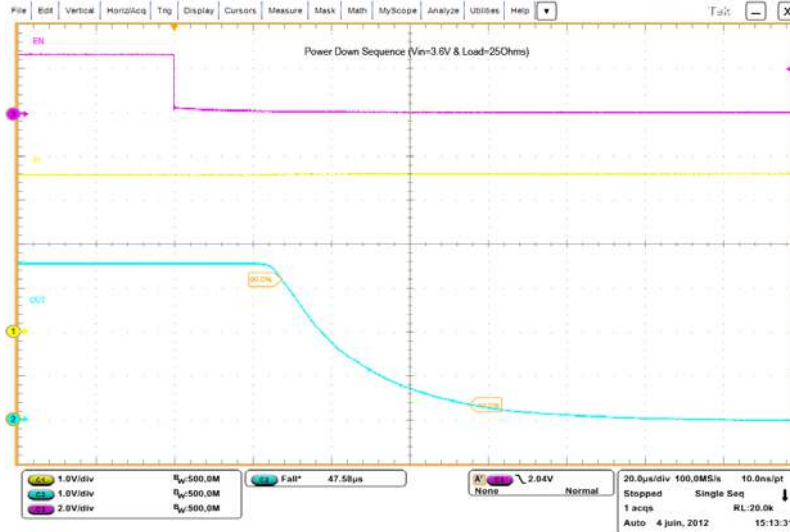

Figure 13. Disable Time and Fall Time

## FUNCTIONAL DESCRIPTION

### Overview

The NCP337 is a high side P channel MOSFET power distribution switch designed to isolate ICs connected on the battery in order to save energy. The part can be turned on, with a wide range of battery from 1.2 V to 5.5 V.

### Enable Input

Enable pin is an active high. The path is opened when EN pin is tied low (disable), forcing P MOS switch off.

The IN/OUT path is activated with a minimum of  $V_{in}$  of 1.2 V and EN forced to high level.

### Auto Discharge

NMOS FET is placed between the output pin and GND, in order to discharge the application capacitor connected on OUT pin.

The auto-discharge is activated when EN pin is set to low level (disable state).

The discharge path (Pull down NMOS) stays activated as long as EN pin is set at low level and  $V_{in} > 1.2$  V.

In order to limit the current across the internal discharge Nmosfet, the typical value is set at 70  $\Omega$ .

### Cin and Cout Capacitors

IN and OUT, 1  $\mu$ F, at least, capacitors must be placed as close as possible the part to for stability improvement.

## APPLICATION INFORMATION

### Power Dissipation

Main contributor in term of junction temperature is the power dissipation of the power MOSFET. Assuming this, the power dissipation and the junction temperature in normal mode can be calculated with the following equations:

- $P_D = R_{DS(on)} \times (I_{OUT})^2$   
 $P_D$  = Power dissipation (W)  
 $R_{DS(on)}$  = Power MOSFET on resistance ( $\Omega$ )  
 $I_{OUT}$  = Output current (A)

- $T_J = P_D \times R_{\theta JA} + T_A$   
 $T_J$  = Junction temperature ( $^{\circ}C$ )  
 $R_{\theta JA}$  = Package thermal resistance ( $^{\circ}C/W$ )  
 $T_A$  = Ambient temperature ( $^{\circ}C$ )

### PCB Recommendations

The NCP337 integrates an up to 3 A rated PMOS FET, and the PCB design rules must be respected to properly evacuate the heat out of the silicon. By increasing PCB area, especially around IN and OUT pins, the  $R_{\theta JA}$  of the package can be decreased, allowing higher power dissipation.

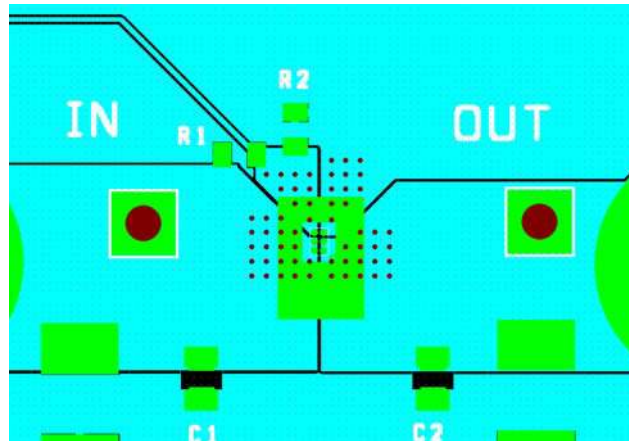

Figure 14. Routing Example: 2 oz, 4 layers with vias across 2 internal inners.

Example of application definition.

$$T_J - T_A = R_{\theta JA} \times P_D = R_{\theta JA} \times R_{DS(on)} \times I^2$$

$T_J$ : junction temperature.

$T_A$ : ambient temperature.

$R_{\theta}$  = Thermal resistance between IC and air, through PCB.

$R_{DS(on)}$ : intrinsic resistance of the IC Mosfet.

I: load DC current.

Taking into account of  $R_{\theta}$  obtain with:

- 1 oz, 2 layers: 100 $^{\circ}C/W$ .

At 3 A, 25 $^{\circ}C$  ambient temperature,  $R_{DS(on)}$  20 m $\Omega$  @  $V_{in}$  5 V, the junction temperature will be:

$$T_J = T_A + R_{\theta} \times P_D = 25 + (0.024 \times 3^2) \times 100 = 43^{\circ}C$$

Taking into account of  $R_{\theta}$  obtain with:

- 2 oz, 4 layers: 60 $^{\circ}C/W$ .

At 3 A, 65 $^{\circ}C$  ambient temperature,  $R_{DS(on)}$  24 m $\Omega$  @  $V_{in}$  5 V, the junction temperature will be:

$$T_J = T_A + R_{\theta} \times P_D = 65 + (0.024 \times 3^2) \times 60 = 78^{\circ}C$$

### ORDERING INFORMATION

Device	Marking	Option	Package	Shipping <sup>†</sup>
NCP337FCT2G	AC	Auto discharge	WLCSP 1 x 1.5 mm	3000 Tape / Reel
NCP336FCT2G	AF	Without Autodischarge	WLCSP 1 x 1.5 mm	3000 Tape / Reel

<sup>†</sup>For information on tape and reel specifications, including part orientation and tape sizes, please refer to our Tape and Reel Packaging Specifications Brochure, BRD8011/D.



# MECHANICAL CASE OUTLINE PACKAGE DIMENSIONS



**WLCSP6 1.0x1.5x0.609**  
CASE 567FH  
ISSUE A

DATE 21 JUN 2022

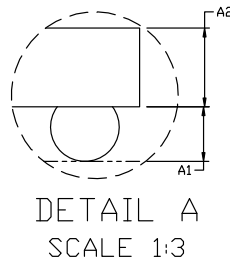
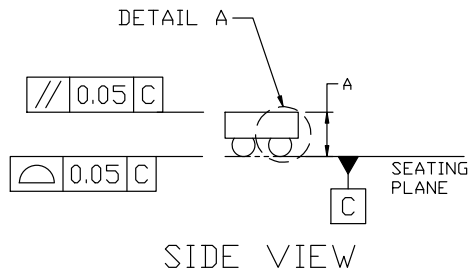
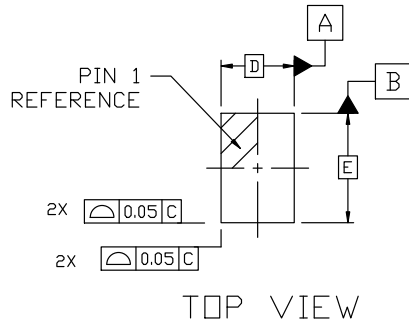

NOTES:

1. DIMENSIONING AND TOLERANCING PER ASME Y14.5M, 1994.
2. CONTROLLING DIMENSION: MILLIMETERS
3. COPLANARITY APPLIES TO THE SPHERICAL CROWNS OF THE SOLDER BALLS.

DIM	MILLIMETERS		
	MIN.	NOM.	MAX.
A	0.554	0.609	0.664
A1	0.219	0.249	0.279
A2	0.335	0.360	0.385
b	0.282	0.312	0.342
D	1.00 BSC		
E	1.50 BSC		
e	0.50 BSC		

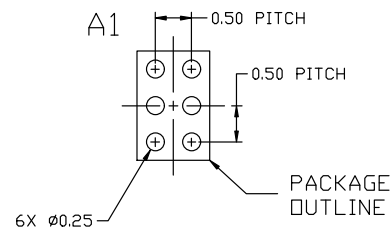
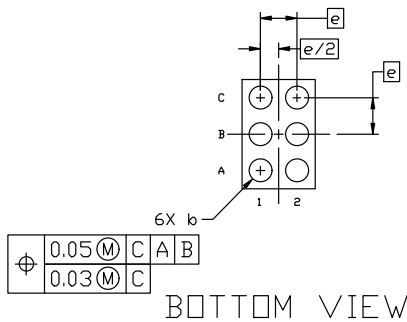

RECOMMENDED  
MOUNTING FOOTPRINT\*

- \* For additional information on our Pb-Free strategy and soldering details, please download the ON Semiconductor Soldering and Mounting Techniques Reference Manual, SOLDERRM/D.

**GENERIC  
MARKING DIAGRAM\***

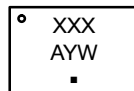

- XXX = Specific Device Code
- A = Assembly Location
- Y = Year
- W = Work Week
- = Pb-Free Package

\*This information is generic. Please refer to device data sheet for actual part marking. Pb-Free indicator, "G" or microdot "▪", may or may not be present. Some products may not follow the Generic Marking.

<b>DOCUMENT NUMBER:</b>	<b>98AON79918E</b>	Electronic versions are uncontrolled except when accessed directly from the Document Repository. Printed versions are uncontrolled except when stamped "CONTROLLED COPY" in red.
<b>DESCRIPTION:</b>	<b>WLCSP6 1.0x1.5x0.609</b>	<b>PAGE 1 OF 1</b>

onsemi and ONSEMI are trademarks of Semiconductor Components Industries, LLC dba onsemi or its subsidiaries in the United States and/or other countries. onsemi reserves the right to make changes without further notice to any products herein. onsemi makes no warranty, representation or guarantee regarding the suitability of its products for any particular purpose, nor does onsemi assume any liability arising out of the application or use of any product or circuit, and specifically disclaims any and all liability, including without limitation special, consequential or incidental damages. onsemi does not convey any license under its patent rights nor the rights of others.

**onsemi**, **Onsemi**, and other names, marks, and brands are registered and/or common law trademarks of Semiconductor Components Industries, LLC dba "**onsemi**" or its affiliates and/or subsidiaries in the United States and/or other countries. **onsemi** owns the rights to a number of patents, trademarks, copyrights, trade secrets, and other intellectual property. A listing of **onsemi**'s product/patent coverage may be accessed at [www.onsemi.com/site/pdf/Patent-Marking.pdf](http://www.onsemi.com/site/pdf/Patent-Marking.pdf). **onsemi** reserves the right to make changes at any time to any products or information herein, without notice. The information herein is provided "as-is" and **onsemi** makes no warranty, representation or guarantee regarding the accuracy of the information, product features, availability, functionality, or suitability of its products for any particular purpose, nor does **onsemi** assume any liability arising out of the application or use of any product or circuit, and specifically disclaims any and all liability, including without limitation special, consequential or incidental damages. Buyer is responsible for its products and applications using **onsemi** products, including compliance with all laws, regulations and safety requirements or standards, regardless of any support or applications information provided by **onsemi**. "Typical" parameters which may be provided in **onsemi** data sheets and/or specifications can and do vary in different applications and actual performance may vary over time. All operating parameters, including "Typicals" must be validated for each customer application by customer's technical experts. **onsemi** does not convey any license under any of its intellectual property rights nor the rights of others. **onsemi** products are not designed, intended, or authorized for use as a critical component in life support systems or any FDA Class 3 medical devices or medical devices with a same or similar classification in a foreign jurisdiction or any devices intended for implantation in the human body. Should Buyer purchase or use **onsemi** products for any such unintended or unauthorized application, Buyer shall indemnify and hold **onsemi** and its officers, employees, subsidiaries, affiliates, and distributors harmless against all claims, costs, damages, and expenses, and reasonable attorney fees arising out of, directly or indirectly, any claim of personal injury or death associated with such unintended or unauthorized use, even if such claim alleges that **onsemi** was negligent regarding the design or manufacture of the part. **onsemi** is an Equal Opportunity/Affirmative Action Employer. This literature is subject to all applicable copyright laws and is not for resale in any manner.

---

## ADDITIONAL INFORMATION

### TECHNICAL PUBLICATIONS:

Technical Library: [www.onsemi.com/design/resources/technical-documentation](http://www.onsemi.com/design/resources/technical-documentation)  
onsemi Website: [www.onsemi.com](http://www.onsemi.com)

### ONLINE SUPPORT: [www.onsemi.com/support](http://www.onsemi.com/support)

For additional information, please contact your local Sales Representative at [www.onsemi.com/support/sales](http://www.onsemi.com/support/sales)