

Thunderbolt IGBT®

The Thunderblot IGBT® is a new generation of high voltage power IGBTs. Using Non- Punch Through Technology, the Thunderblot IGBT® offers superior ruggedness and ultrafast switching speed.

- Low Forward Voltage Drop
- High Freq. Switching to 100KHz
- Low Tail Current
- Ultra Low Leakage Current
- RBSOA and SCSOA Rated

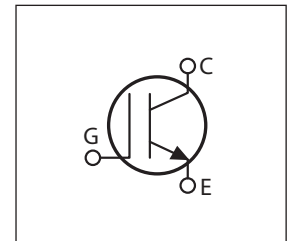
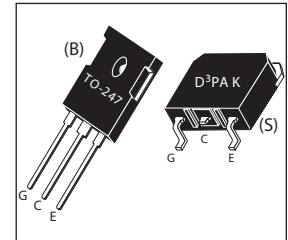

MAXIMUM RATINGS

All Ratings: $T_C = 25^\circ\text{C}$ unless otherwise specified.

Symbol	Parameter	APT50GT60BR_SR(G)	UNIT
V_{CES}	Collector-Emitter Voltage	600	Volts
V_{GE}	Gate-Emitter Voltage	± 30	
I_{C1}	Continuous Collector Current ⁷ @ $T_C = 25^\circ\text{C}$	110	Amps
I_{C2}	Continuous Collector Current @ $T_C = 110^\circ\text{C}$	52	
I_{CM}	Pulsed Collector Current ¹	150	
SSOA	Switching Safe Operating Area @ $T_j = 150^\circ\text{C}$	150A @ 600V	
P_D	Total Power Dissipation	446	Watts
T_j, T_{STG}	Operating and Storage Junction Temperature Range	-55 to 150	°C
T_L	Max. Lead Temp. for Soldering: 0.063" from Case for 10 Sec.	300	

STATIC ELECTRICAL CHARACTERISTICS

Symbol	Characteristic / Test Conditions	MIN	TYP	MAX	Units
$V_{(BR)CES}$	Collector-Emitter Breakdown Voltage ($V_{GE} = 0V, I_C = 2mA$)	600			Volts
$V_{GE(TH)}$	Gate Threshold Voltage ($V_{CE} = V_{GE}, I_C = 1mA, T_j = 25^\circ\text{C}$)	3	4	5	
$V_{CE(ON)}$	Collector-Emitter On Voltage ($V_{GE} = 15V, I_C = 50A, T_j = 25^\circ\text{C}$)	1.7	2.0	2.5	
	Collector-Emitter On Voltage ($V_{GE} = 15V, I_C = 50A, T_j = 125^\circ\text{C}$)		2.2		
I_{CES}	Collector Cut-off Current ($V_{CE} = 600V, V_{GE} = 0V, T_j = 25^\circ\text{C}$) ²			25	μA
	Collector Cut-off Current ($V_{CE} = 600V, V_{GE} = 0V, T_j = 125^\circ\text{C}$) ²			TBD	
I_{GES}	Gate-Emitter Leakage Current ($V_{GE} = \pm 20V$)			120	nA

CAUTION: These Devices are Sensitive to Electrostatic Discharge. Proper Handling Procedures Should Be Followed.

DYNAMIC CHARACTERISTICS

APT50GT60BR_SR(G)

Symbol	Characteristic	Test Conditions	MIN	TYP	MAX	UNIT
C_{ies}	Input Capacitance	Capacitance $V_{GE} = 0V, V_{CE} = 25V$ $f = 1 \text{ MHz}$		2660		pF
C_{oes}	Output Capacitance			250		
C_{res}	Reverse Transfer Capacitance			153		
V_{GEP}	Gate-to-Emitter Plateau Voltage	Gate Charge $V_{GE} = 15V$ $V_{CE} = 300V$ $I_C = 50A$		7.5		V
Q_g	Total Gate Charge ³			240		nC
Q_{ge}	Gate-Emitter Charge			20		
Q_{gc}	Gate-Collector ("Miller") Charge			110		
SSOA	Switching Safe Operating Area	$T_J = 150^\circ\text{C}, R_G = 4.3\Omega, V_{GE} = 15V, L = 100\mu\text{H}, V_{CE} = 600V$	150			A
$t_{d(on)}$	Turn-on Delay Time	Inductive Switching (25°C) $V_{CC} = 400V$ $V_{GE} = 15V$ $I_C = 50A$ $R_G = 4.3\Omega$ $T_J = +25^\circ\text{C}$		14		ns
t_r	Current Rise Time			32		
$t_{d(off)}$	Turn-off Delay Time			240		
t_f	Current Fall Time			36		
E_{on1}	Turn-on Switching Energy ⁴			995		μJ
E_{on2}	Turn-on Switching Energy (Diode) ⁵			1110		
E_{off}	Turn-off Switching Energy ⁶			1070		
$t_{d(on)}$	Turn-on Delay Time	Inductive Switching (125°C) $V_{CC} = 400V$ $V_{GE} = 15V$ $I_C = 50A$ $R_G = 4.3\Omega$ $T_J = +125^\circ\text{C}$		14		ns
t_r	Current Rise Time			32		
$t_{d(off)}$	Turn-off Delay Time			270		
t_f	Current Fall Time			95		
E_{on1}	Turn-on Switching Energy ⁴			1035		μJ
E_{on2}	Turn-on Switching Energy (Diode) ⁵			1655		
E_{off}	Turn-off Switching Energy ⁶			1505		

THERMAL AND MECHANICAL CHARACTERISTICS

Symbol	Characteristic	MIN	TYP	MAX	UNIT
$R_{\theta JC}$	Junction to Case (IGBT)			.28	$^\circ\text{C/W}$
$R_{\theta JC}$	Junction to Case (DIODE)			N/A	
W_T	Package Weight		5.9		gm

- ① Repetitive Rating: Pulse width limited by maximum junction temperature.
- ② For Combi devices, I_{ces} includes both IGBT and FRED leakages
- ③ See MIL-STD-750 Method 3471.
- ④ E_{on1} is the clamped inductive turn-on energy of the IGBT only, without the effect of a commutating diode reverse recovery current adding to the IGBT turn-on loss. Tested in inductive switching test circuit shown in figure 21, but with a Silicon Carbide diode.
- ⑤ E_{on2} is the clamped inductive turn-on energy that includes a commutating diode reverse recovery current in the IGBT turn-on switching loss. (See Figures 21, 22.)
- ⑥ E_{off} is the clamped inductive turn-off energy measured in accordance with JEDEC standard JESD24-1. (See Figures 21, 23.)
- ⑦ Continuous current limited by package lead temperature.

Microsemi reserves the right to change, without notice, the specifications and information contained herein.

TYPICAL PERFORMANCE CURVES

APT50GT60BR_SR(G)

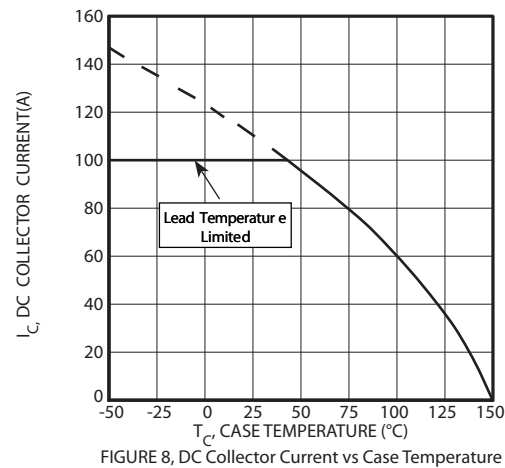
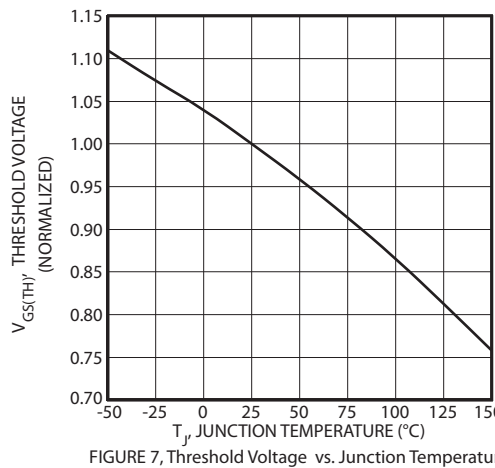
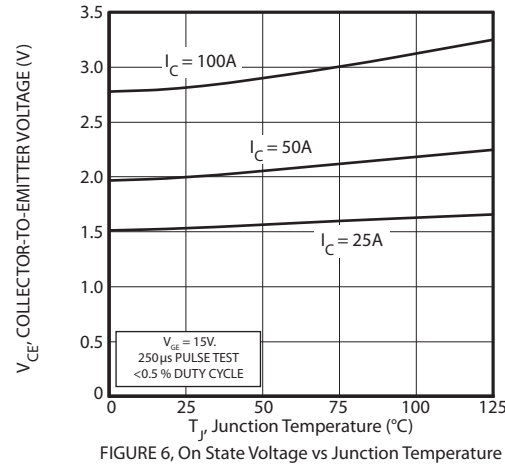
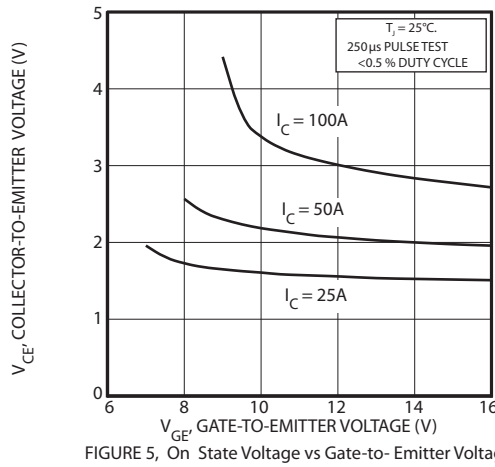
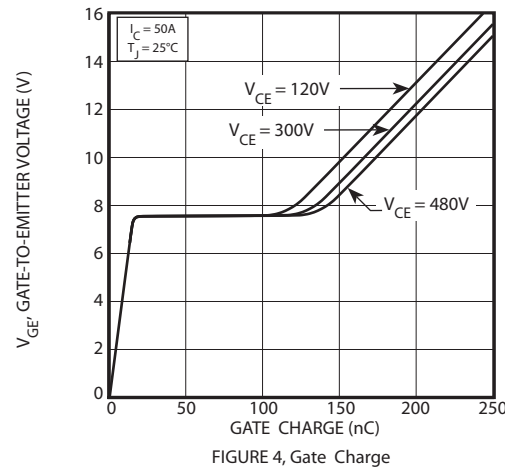
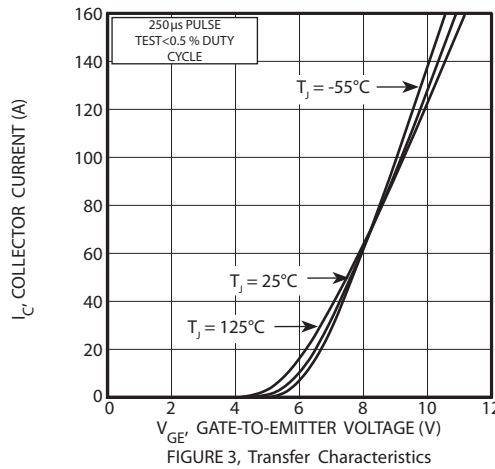
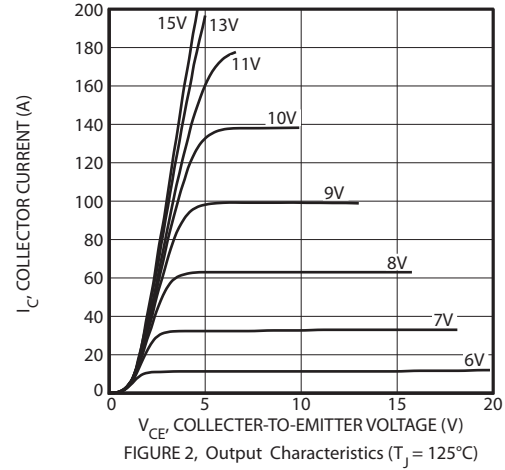
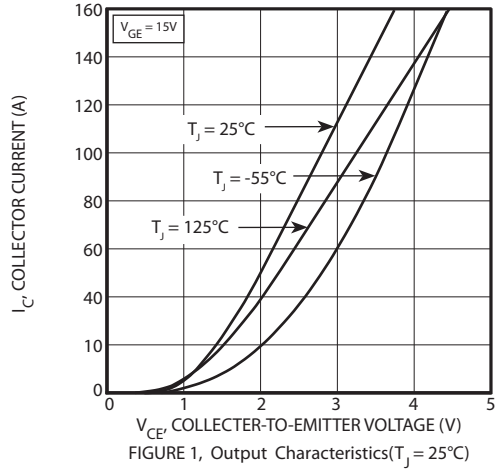

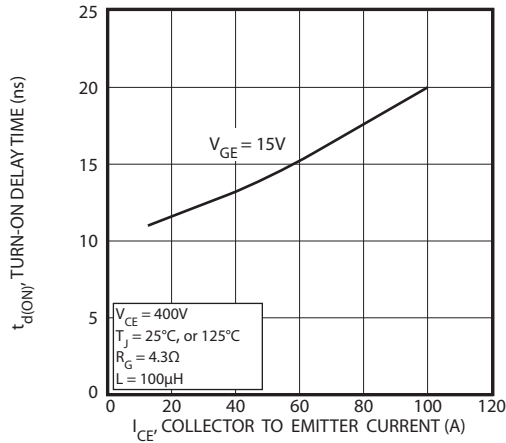

FIGURE 9, Turn-On Delay Time vs Collector Current

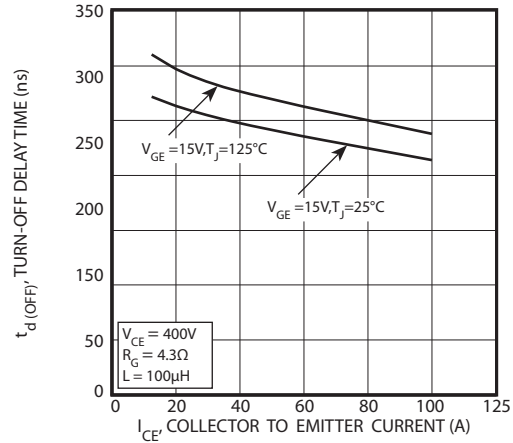

FIGURE 10, Turn-Off Delay Time vs Collector Current

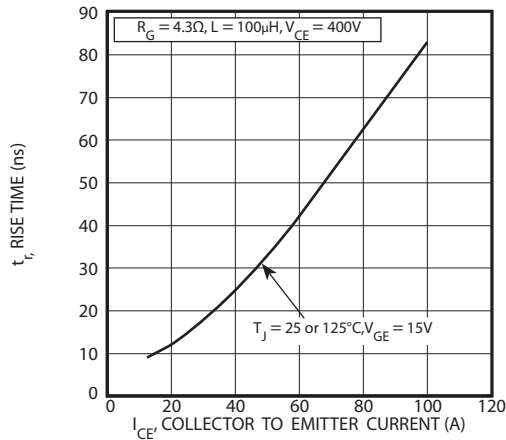

FIGURE 11, Current Rise Time vs Collector Current

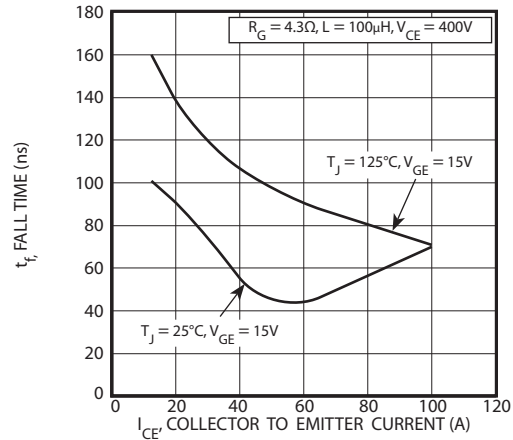

FIGURE 12, Current Fall Time vs Collector Current

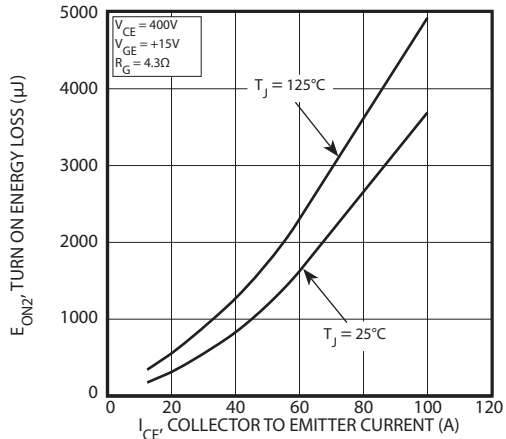

FIGURE 13, Turn-On Energy Loss vs Collector Current

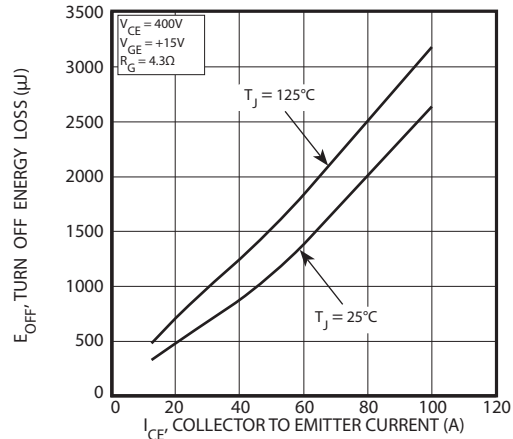

FIGURE 14, Turn Off Energy Loss vs Collector Current

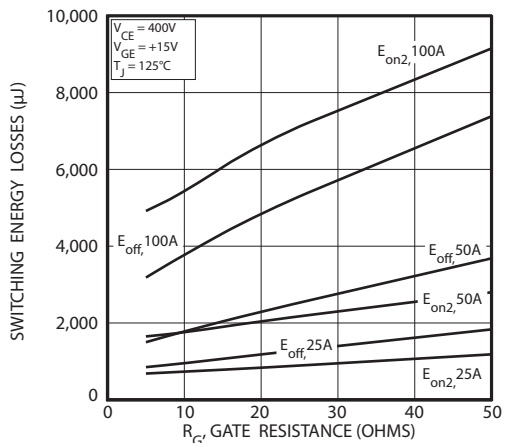

FIGURE 15, Switching Energy Losses vs. Gate Resistance

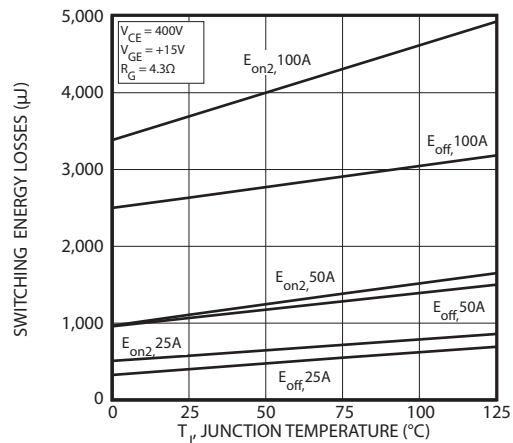

FIGURE 16, Switching Energy Losses vs Junction Temperature

TYPICAL PERFORMANCE CURVES

APT50GT60BR_SR(G)

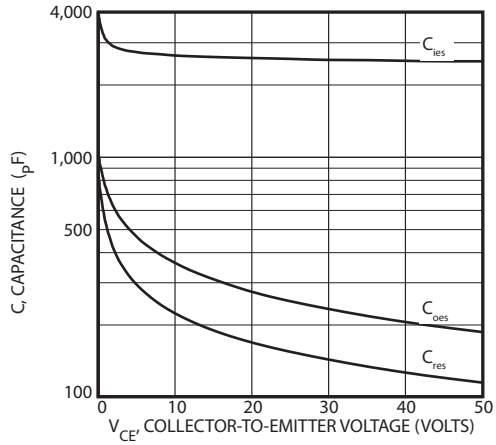

Figure 17, Capacitance vs Collector-To-Emitter Voltage

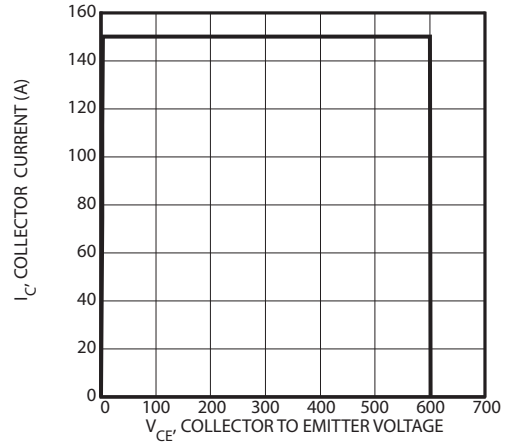

Figure 18, Minimum Switching Safe Operating Area

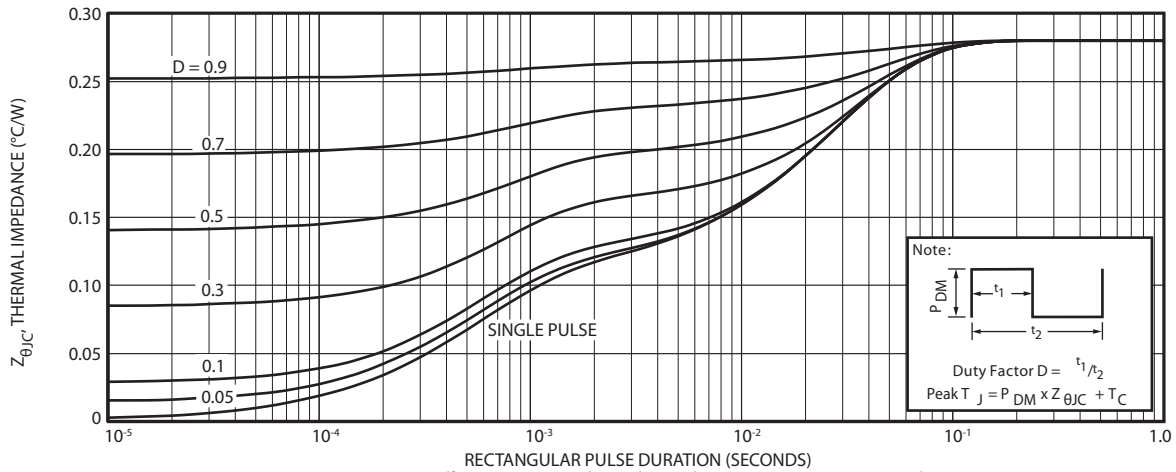

Figure 19a, Maximum Effective Transient Thermal Impedance, Junction-To-Case vs Pulse Duration

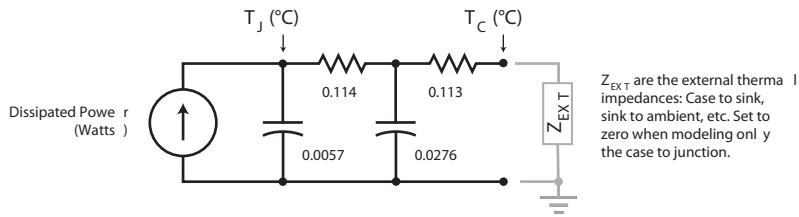

FIGURE 19b, TRANSIENT THERMAL IMPEDANCE MODEL

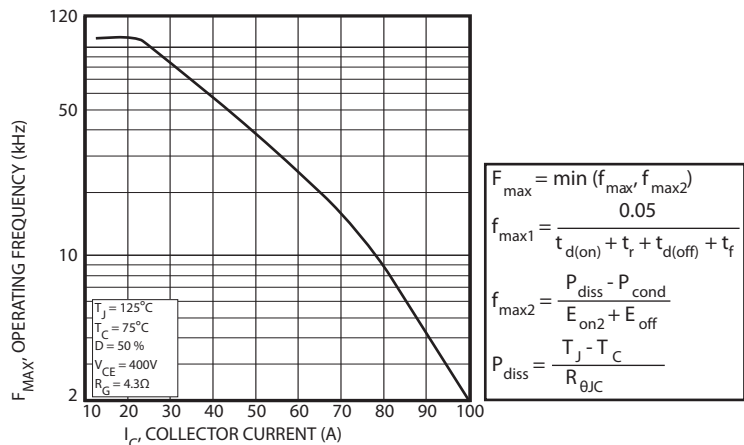

Figure 20, Operating Frequency vs Collector Current

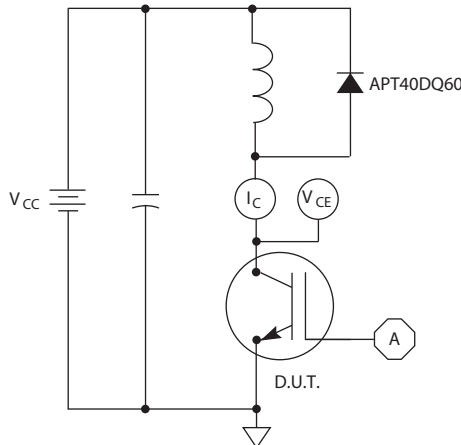

Figure 21, Inductive Switching Test Circuit

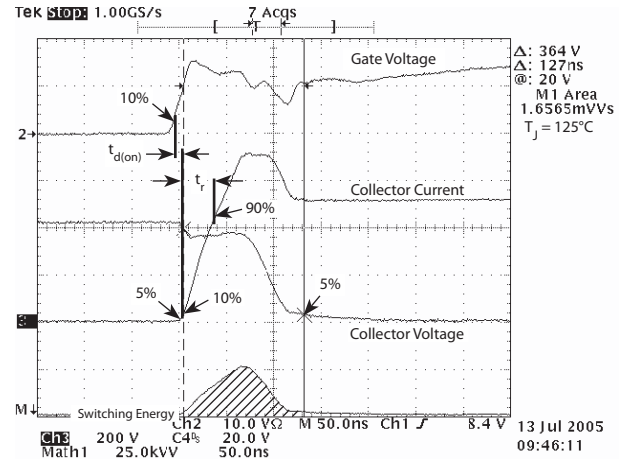

Figure 22, Turn-on Switching Waveforms and Definitions

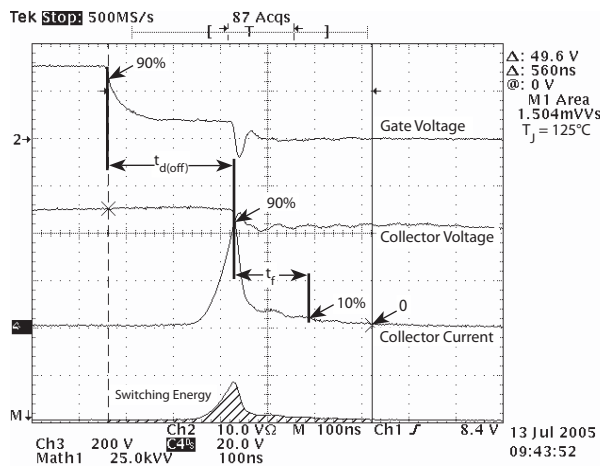
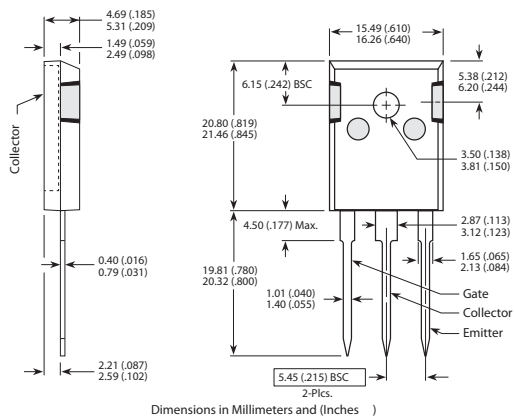

Figure 23, Turn-off Switching Waveforms and Definitions

TO-247 Package Outline

(e1) SAC: Tin, Silver, Copper



D³PAK Package Outline

(e3) SAC: Tin, Silver, Copper

