

- *Designed for SDARS IF Receiver*
- *Low Insertion Loss*
- *5.0 x 5.0 mm Surface-mount Case*
- *Differential or Single-ended Input and Output*
- *Complies with Directive 2002/95/EC (RoHS)*
- *Moisture Sensitivity Level: 1*
- *AEC-Q200 Qualified*

SF2038C-1

**76.500 MHz
SAW Filter**

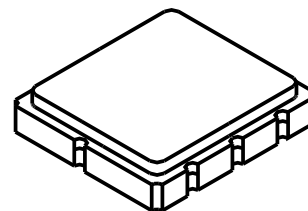

SM5050-8

Absolute Maximum Ratings

Rating	Value	Units
Maximum Incident Power in Passband	+10	dBm
Maximum DC Voltage on any Non-ground Terminal	30	VDC
Storage Temperature Range in Tape and Reel	-40 to +85	°C
Maximum Soldering Profile	265°C for 10 s	

Electrical Characteristics

Characteristic	Sym	Notes	Min	Typ	Max	Units
Nominal Center Frequency	f_C			76.500		MHz
Passband Insertion Loss	IL			10.8	12.5	dB
1 dB Bandwidth	BW_1		12.0	12.7		MHz
15 dB Bandwidth	BW_{15}			17.5	18.0	MHz
30 dB Bandwidth	BW_{30}			19.4	20.0	MHz
Amplitude Ripple over $f_c \pm 6.0$ MHz				0.60	1.4	dB _{p-p}
Group Delay Variation over $f_c \pm 6.0$ MHz	GDV			40	150	ns _{p-p}
Rejection:						dB
50 to 64.44 MHz			35.5	42		
64.44 to 66.70 MHz			30.5	39		
86.30 to 87.06 MHz			16*	24		
87.06 to 91.50 MHz			23*	34		
91.50 to 100.000 MHz			36	40		
Operating Temperature Range	T_A		-40		+105	°C
Frequency Temperature Coefficient	FTC			-87		ppm/°C
Differential Input				175 ohms		
Differential Output				180 ohms		
Case Style				SM5050-8 5 x 5 mm Nominal Footprint		
Lid Symbolization (Y=year, WW=week, S=shift)				A11, <u>YWWS</u>		

*At low temperature extreme -40 °C

 **CAUTION: Electrostatic Sensitive Device. Observe precautions for handling.**

NOTES:

1. The design, manufacturing process, and specifications of this device are subject to change.
2. US or International patents may apply.
3. RoHS compliant from the first date of manufacture.

Filter Response, 36.5 to 116.5 MHz

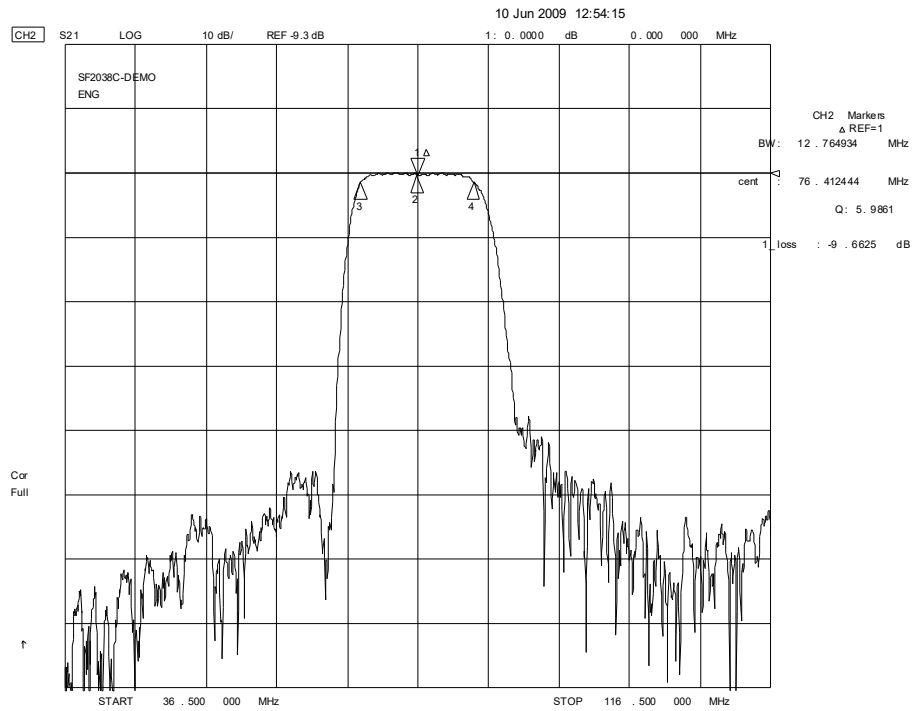

Filter Passband Response

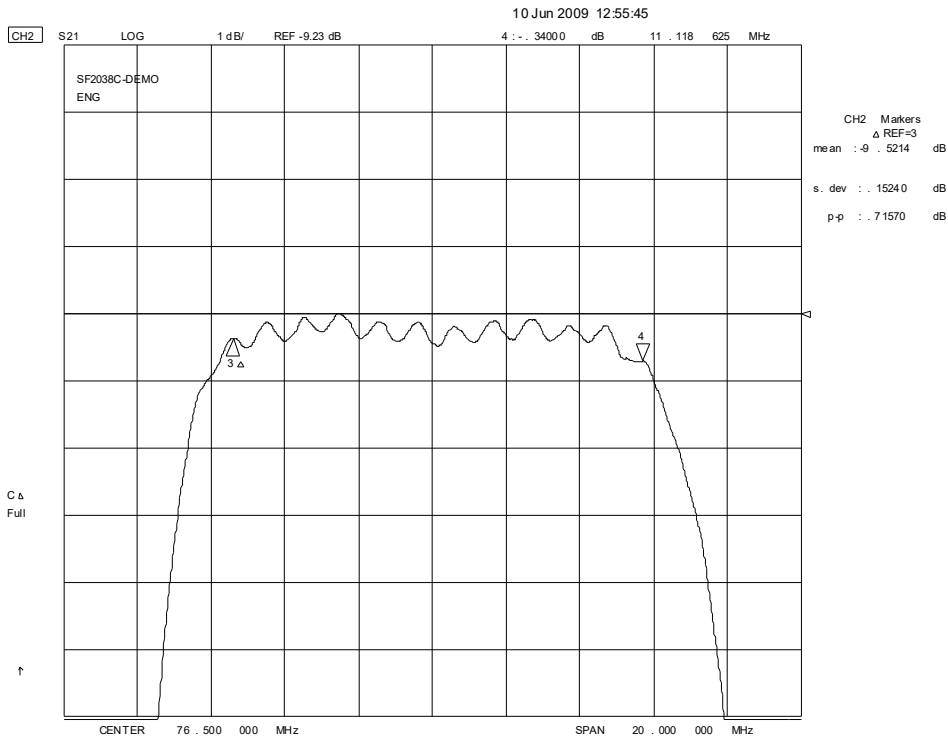

Filter Passband Group Delay Response

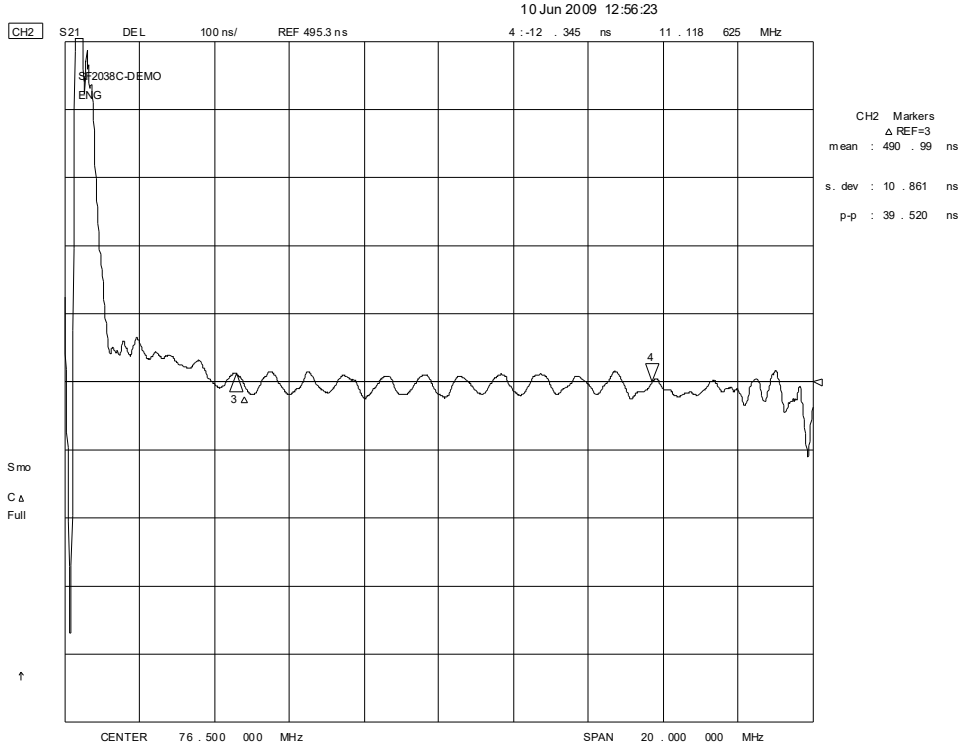

Filter S₁₁ and S₂₂ Plots

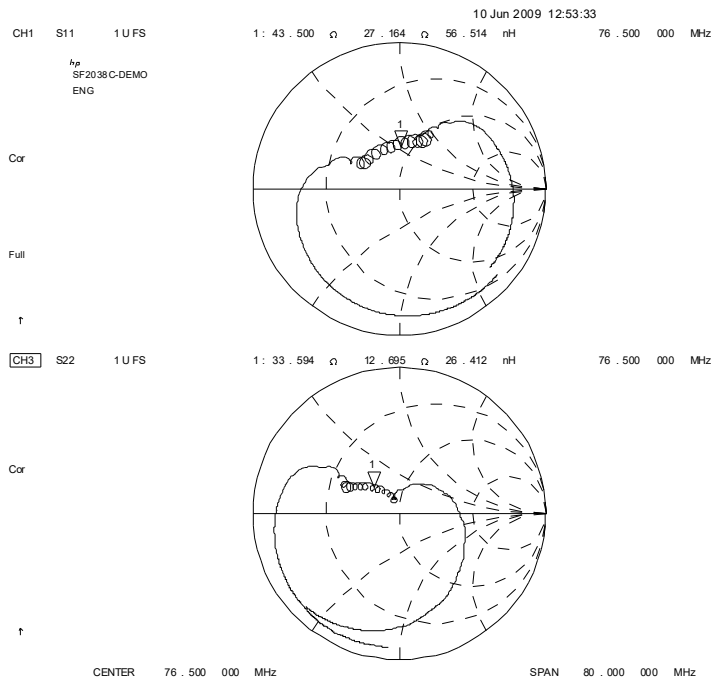

SM5050-8 Surface-Mount 8-Terminal Ceramic Case 5.0 X 5.0 mm Nominal Footprint

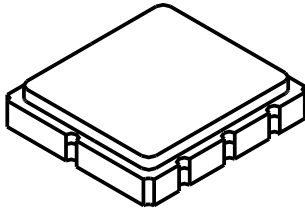

Case Dimensions

Dimension	mm			Inches		
	Min	Nom	Max	Min	Nom	Max
A	4.80	5.00	5.20	0.189	0.197	0.205
B	4.80	5.00	5.20	0.189	0.197	0.205
C	1.30	1.50	1.70	0.050	0.060	0.067
D	1.98	2.08	2.18	0.078	0.082	0.086
E	1.07	1.17	1.27	0.042	0.046	0.050
F	0.50	0.64	0.70	0.020	0.025	0.028
G	2.39	2.54	2.69	0.094	0.100	0.106
H		1.27			0.050	
I		0.76			0.030	
J		1.55			0.061	
K		2.79			0.110	
L		0.76			0.030	
M		2.36			0.093	
N		1.55			0.061	
O		2.79			0.110	
P		2.79			0.110	
Q		2.79			0.110	

PCB Footprint

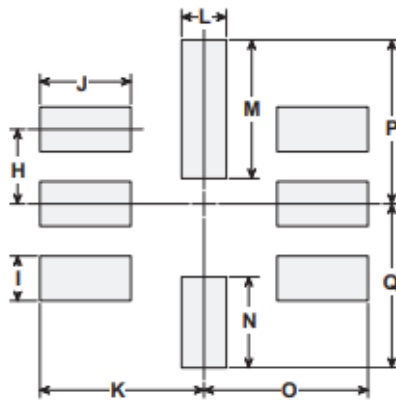

Case Materials

Materials	
Solder Pad Plating	0.3 to 1.0 μm Gold over 1.27 to 8.89 μm Nickel
Lid Plating	2.0 to 3.0 μm Nickel
Body	Al_2O_3 Ceramic

Electrical Connections

Connection	Terminals
Port 1	Differential Input 1, 2
Port 2	Differential Output 5, 6
	Ground All others
Single-ended Operation	Return is ground
Differential Operation	Return is hot
Dot indicates Pin 1	

Test Circuit

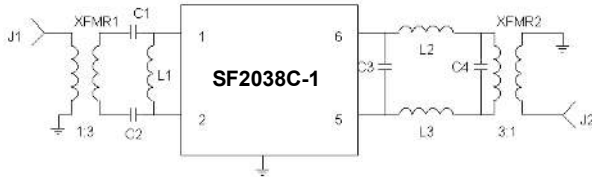

- L1 330 nH
- L2, L3 270 nH
- C1, C4 18 pF
- C2 15 pF
- C3 1 pF
- XFMR1, XFMR 2 3:1
- XFMR1, XFMR 2 3:1

TOP VIEW

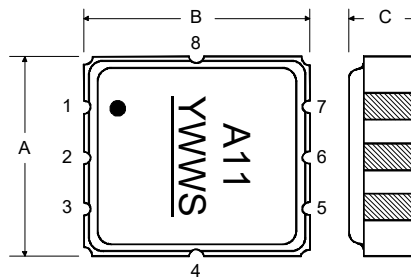

BOTTOM VIEW

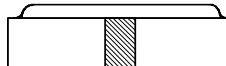
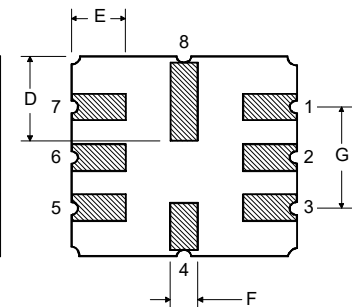

Tape and Reel Specifications

Tape and Reel Standard per ANSI/EIA481

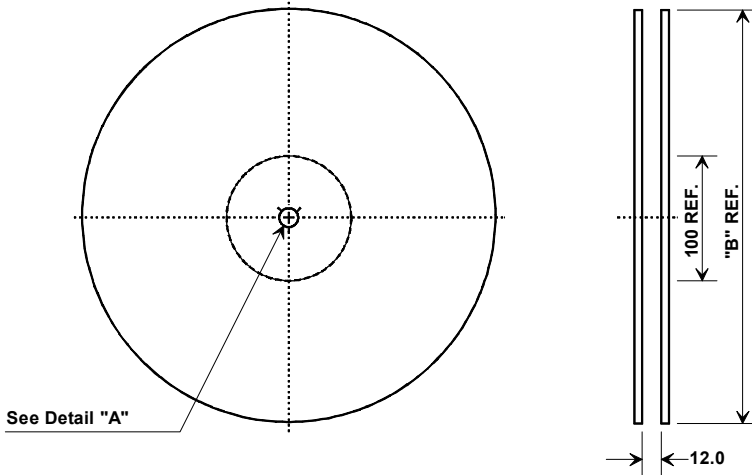

"B" Nominal Size		Quantity Per Reel
Inches	millimeters	
7	178	500
13	330	3000

See Detail "A"

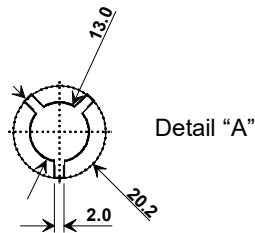

COMPONENT ORIENTATION and DIMENSIONS

Carrier Tape Dimensions	
Ao	5.3 mm
Bo	5.3 mm
Ko	2.0 mm
Pitch	8.0 mm
W	12.0 mm

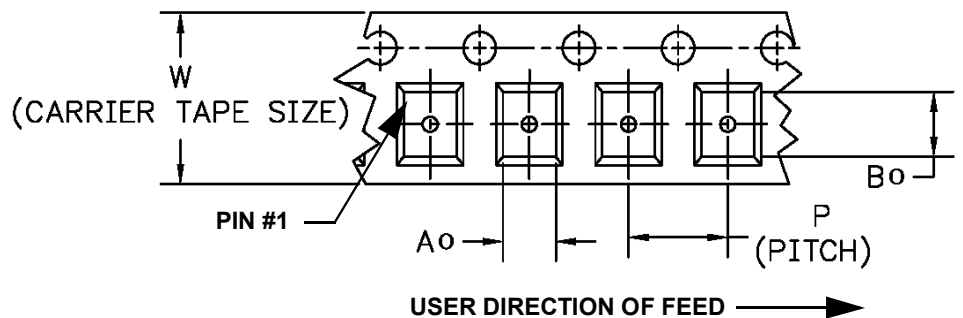
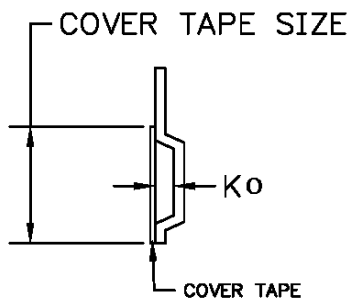

Recommended Reflow Profile

1. Preheating shall be fixed at 150~180° for 60~90 seconds.
2. Ascending time to preheating temperature 150° shall be 30 seconds min.
3. Heating shall be fixed at 220°C for 50~80 seconds and at 260°C peak (10 seconds.)
4. Time: 5 times maximum

