

4

3

2

1

THIS DRAWING IS UNPUBLISHED. RELEASED FOR PUBLICATION 2010
 © COPYRIGHT 2010 BY TYCO ELECTRONICS CORPORATION. ALL RIGHTS RESERVED.

LOC	DIST	REVISIONS			
P	LTR	DESCRIPTION	DATE	DWN	APVD
E	B	BA	NEW RELEASE	04AUG2010	PT St.P

FOR FURTHER INFORMATION SEE DATA SHEET FOR
 SERIES SC - AXIAL LEADED POWER INDUCTORS

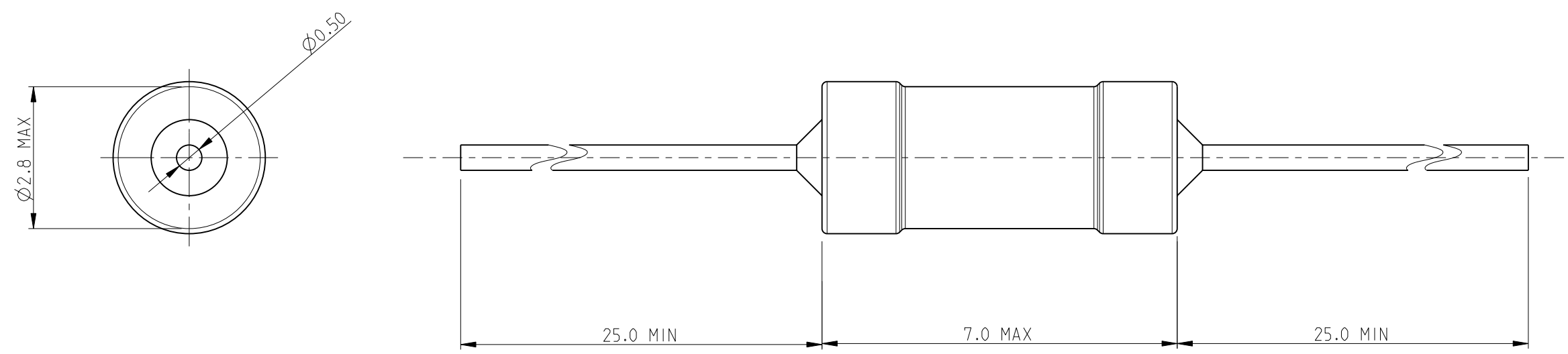

RoHS Compliant



<small>THIS DRAWING IS A CONTROLLED DOCUMENT FOR TYCO ELECTRONICS CORPORATION IT IS SUBJECT TO CHANGE AND THE CONTROLLING ENGINEERING ORGANIZATION SHOULD BE CONTACTED FOR THE LATEST REVISION.</small>		DWN 04AUG2010 PARUSURAM.T CHK 04AUG2010 ALLAN.P APVD 04AUG2010 STEPHEN.P PRODUCT SPEC - APPLICATION SPEC - WEIGHT -		Tyco Electronics Corporation Dorcan, Swindon, SN3 5HH NAME AXIAL LEADED POWER INDUCTORS SERIES SC30	
DIMENSIONS: mm 	TOLERANCES UNLESS OTHERWISE SPECIFIED: 0 PLC ±0.2 1 PLC ±0.1 2 PLC ±- 3 PLC ±- 4 PLC ±- ANGLES ±5° MATERIAL - FINISH -	SIZE A3 CAGE CODE 00779 DRAWING NO C-1624014 RESTRICTED TO -	CUSTOMER DRAWING SCALE 10:1 SHEET 1 OF 1 REV BA		