

BQ25970, BQ25971 I²C Controlled Single Cell High Efficiency 8-A Switched Cap Fast Chargers With ADC

1 Features

- 97% Efficient power stage for 8-A fast charge
- Patent pending switched cap charger architecture optimized for 50% duty cycle
 - Input voltage is 2x battery voltage (3.5 V to 4.65 V)
 - Output current is 2x of input current (up to 4.5 A)
 - Reduces power loss across the cable
- Integrated programmable protection features for safe operation
 - Input over-voltage protection (BUS_OVP)
 - Input over-current protection (BUS_OCP) with adjustable alarm
 - Input over-voltage with external OVP FET (VAC_OVP up to 17 V, BQ25970 only)
 - Battery over-voltage protection (BAT_OVP) with adjustable alarm
 - Output over-voltage (VOUT_OVP)
 - Input over-current protection (BUS_OCP) with adjustable alarm
 - IBAT over-current protection (BAT_OCP) with adjustable alarm
 - Switching MOSFET cycle by cycle current limit
 - Battery temperature monitoring
 - Connector Temperature Monitoring
- Programmable settings for system optimization
 - Optional VBATREG and IBATREG regulation for system load and wall adapter transients (BQ25970 only with External OVP FET)
 - STAT, FLAG, and MASK options for interrupts
 - ADC Readings and configuration

- Integrated 12-bit effective analog-to digital converter (ADC)
 - $\pm 0.5\%$ BUS Voltage
 - $\pm 0.5\%$ VOUT Voltage
 - -0.4% to 0.2% BAT Voltage with differential sensing
 - $\pm 1.5\%$ BAT Current at 6 A with external R_{SENSE}
 - $\pm 1\%$ BAT Temperature
 - $\pm 1\%$ BUS Temperature
 - $\pm 4^\circ\text{C}$ Die temperature

2 Applications

- [Smartphone](#)
- [Tablet PC](#)

3 Description

The BQ2597x is a 97% efficient, 8-A battery charging solution using a switched cap architecture. This architecture and the integrated FETs are optimized to enable a 50% duty cycle, allowing the cable current to be half the current delivered to the battery, reducing the losses over the charging cable as well as limiting the temperature rise in the application.

Device Information⁽¹⁾

| PART NUMBER | PACKAGE | BODY SIZE (NOM) |
|------------------------|------------|-------------------|
| BQ25970 ⁽²⁾ | DSBGA (56) | 3.00 mm x 3.20 mm |
| BQ25971 ⁽³⁾ | DSBGA (56) | 3.00 mm x 3.20 mm |

(1) For all available packages, see the orderable addendum at the end of the data sheet.

(2) External OVP Capable

(3) No External OVP

Simplified Application

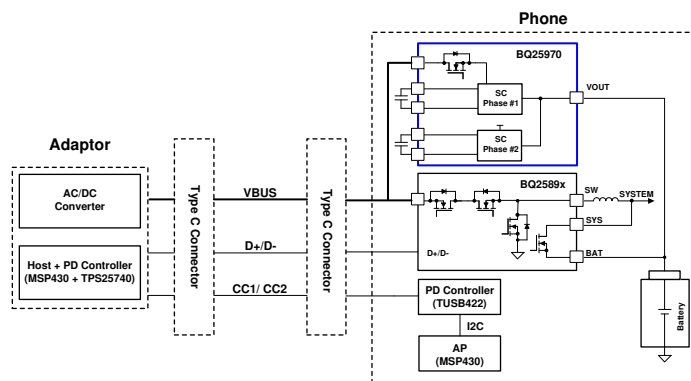

4 Revision History

Changes from Revision A (December 2017) to Revision B Page

- Changed Switched Cap Architecture Optimized for 50% Duty Cycle to Patent pending switched cap charger architecture optimized for 50% duty cycle in Features 1
-

Changes from Original (November 2017) to Revision A Page

- Deleted $\pm 5\%$ BUS Current at 4 A in Features 1
 - Changed $\pm 1\%$ BAT Current at 6 A with External R_{SENSE} to $\pm 1.5\%$ BAT Current at 6 A with External R_{SENSE} in Features.... 1
-

5 Description (continued)

The dual-phase architecture reduces the input cap requirements as well as reducing the output voltage ripple. When used with a standard charger such as the BQ2589x, the system enables the fastest charging at the lowest power loss from pre-charge through CC, CV, and termination.

The device integrates all the necessary protection features to ensure safe charging, including input over-voltage and over-current protection, output over-voltage and over-current protection, temperature sensing for the battery and cable, and monitoring the die temperature.

The device includes a 12-bit effective analog-to-digital converter (ADC) to provide bus voltage, bus current, output voltage, battery voltage, battery current, bus temperature, bat temperature, die temperature, and other calculated measurements needed to manage the charging of the battery from the smart wall adapter or power bank.

6 Device and Documentation Support

6.1 Device Support

6.1.1 Third-Party Products Disclaimer

TI'S PUBLICATION OF INFORMATION REGARDING THIRD-PARTY PRODUCTS OR SERVICES DOES NOT CONSTITUTE AN ENDORSEMENT REGARDING THE SUITABILITY OF SUCH PRODUCTS OR SERVICES OR A WARRANTY, REPRESENTATION OR ENDORSEMENT OF SUCH PRODUCTS OR SERVICES, EITHER ALONE OR IN COMBINATION WITH ANY TI PRODUCT OR SERVICE.

6.1.2 Device Nomenclature

IADAPT (A) Output current of adapter

VADAPT (V) Output voltage of adapter

VCONADROP (V) Voltage drop across the adapter connector

VCONA (V) Output voltage after adapter connector (same as the voltage at the beginning of the cable)

VCABLEDROP (V) Voltage drop

VCABLED (V) Voltage at the cable, going into the device

VCOND (V) Output voltage after the device connector

VDEVCON (V) Output voltage after the device control FETs (controlled by the PD controller)

IIN (A) Input current to the BQ2597x

VIN (V) Input voltage to the BQ2597x

VOUT (V) Output voltage of the BQ2597x

VCONBDROP (V) Voltage drop across the battery connector and sense resistor

VBAT (V) Voltage at the battery

IBAT (A) Current at the battery

6.2 Documentation Support

6.2.1 Related Documentation

For related documentation see the following:

- [BQ2597xEVM-xxx User's Guide](#)

6.3 Related Links

The table below lists quick access links. Categories include technical documents, support and community resources, tools and software, and quick access to sample or buy.

Table 1. Related Links

| PARTS | PRODUCT FOLDER | ORDER NOW | TECHNICAL DOCUMENTS | TOOLS & SOFTWARE | SUPPORT & COMMUNITY |
|---------|----------------------------|----------------------------|----------------------------|----------------------------|----------------------------|
| BQ25970 | Click here | Click here | Click here | Click here | Click here |
| BQ25971 | Click here | Click here | Click here | Click here | Click here |

6.4 Receiving Notification of Documentation Updates

To receive notification of documentation updates, navigate to the device product folder on ti.com. In the upper right corner, click on *Alert me* to register and receive a weekly digest of any product information that has changed. For change details, review the revision history included in any revised document.

6.5 Community Resources

[TI E2E™ support forums](#) are an engineer's go-to source for fast, verified answers and design help — straight from the experts. Search existing answers or ask your own question to get the quick design help you need.

Linked content is provided "AS IS" by the respective contributors. They do not constitute TI specifications and do not necessarily reflect TI's views; see TI's [Terms of Use](#).

6.6 Trademarks

E2E is a trademark of Texas Instruments.

All other trademarks are the property of their respective owners.

6.7 Electrostatic Discharge Caution



This integrated circuit can be damaged by ESD. Texas Instruments recommends that all integrated circuits be handled with appropriate precautions. Failure to observe proper handling and installation procedures can cause damage.

ESD damage can range from subtle performance degradation to complete device failure. Precision integrated circuits may be more susceptible to damage because very small parametric changes could cause the device not to meet its published specifications.

6.8 Glossary

[SLYZ022](#) — *TI Glossary*.

This glossary lists and explains terms, acronyms, and definitions.

7 Mechanical, Packaging, and Orderable Information

The following pages include mechanical, packaging, and orderable information. This information is the most current data available for the designated devices. This data is subject to change without notice and revision of this document. For browser-based versions of this data sheet, refer to the left-hand navigation.

PACKAGING INFORMATION

| Orderable Device | Status (1) | Package Type | Package Drawing | Pins | Package Qty | Eco Plan (2) | Lead finish/ Ball material (6) | MSL Peak Temp (3) | Op Temp (°C) | Device Marking (4/5) | Samples |
|------------------|---------------|--------------|-----------------|------|-------------|-----------------|--------------------------------------|----------------------|--------------|-------------------------|-------------------------|
| BQ25970YFFR | ACTIVE | DSBGA | YFF | 56 | 3000 | RoHS & Green | SNAGCU | Level-1-260C-UNLIM | -40 to 85 | BQ25970 | Samples |
| BQ25970YFFT | ACTIVE | DSBGA | YFF | 56 | 250 | RoHS & Green | SNAGCU | Level-1-260C-UNLIM | -40 to 85 | BQ25970 | Samples |
| BQ25971YFFR | ACTIVE | DSBGA | YFF | 56 | 3000 | RoHS & Green | SNAGCU | Level-1-260C-UNLIM | -40 to 85 | BQ25971 | Samples |
| BQ25971YFFT | ACTIVE | DSBGA | YFF | 56 | 250 | RoHS & Green | SNAGCU | Level-1-260C-UNLIM | -40 to 85 | BQ25971 | Samples |

(1) The marketing status values are defined as follows:

ACTIVE: Product device recommended for new designs.

LIFEBUY: TI has announced that the device will be discontinued, and a lifetime-buy period is in effect.

NRND: Not recommended for new designs. Device is in production to support existing customers, but TI does not recommend using this part in a new design.

PREVIEW: Device has been announced but is not in production. Samples may or may not be available.

OBSELETE: TI has discontinued the production of the device.

(2) **RoHS:** TI defines "RoHS" to mean semiconductor products that are compliant with the current EU RoHS requirements for all 10 RoHS substances, including the requirement that RoHS substance do not exceed 0.1% by weight in homogeneous materials. Where designed to be soldered at high temperatures, "RoHS" products are suitable for use in specified lead-free processes. TI may reference these types of products as "Pb-Free".

RoHS Exempt: TI defines "RoHS Exempt" to mean products that contain lead but are compliant with EU RoHS pursuant to a specific EU RoHS exemption.

Green: TI defines "Green" to mean the content of Chlorine (Cl) and Bromine (Br) based flame retardants meet JS709B low halogen requirements of <=1000ppm threshold. Antimony trioxide based flame retardants must also meet the <=1000ppm threshold requirement.

(3) MSL, Peak Temp. - The Moisture Sensitivity Level rating according to the JEDEC industry standard classifications, and peak solder temperature.

(4) There may be additional marking, which relates to the logo, the lot trace code information, or the environmental category on the device.

(5) Multiple Device Markings will be inside parentheses. Only one Device Marking contained in parentheses and separated by a "-" will appear on a device. If a line is indented then it is a continuation of the previous line and the two combined represent the entire Device Marking for that device.

(6) Lead finish/Ball material - Orderable Devices may have multiple material finish options. Finish options are separated by a vertical ruled line. Lead finish/Ball material values may wrap to two lines if the finish value exceeds the maximum column width.

Important Information and Disclaimer:The information provided on this page represents TI's knowledge and belief as of the date that it is provided. TI bases its knowledge and belief on information provided by third parties, and makes no representation or warranty as to the accuracy of such information. Efforts are underway to better integrate information from third parties. TI has taken and

continues to take reasonable steps to provide representative and accurate information but may not have conducted destructive testing or chemical analysis on incoming materials and chemicals. TI and TI suppliers consider certain information to be proprietary, and thus CAS numbers and other limited information may not be available for release.

In no event shall TI's liability arising out of such information exceed the total purchase price of the TI part(s) at issue in this document sold by TI to Customer on an annual basis.

TAPE AND REEL INFORMATION

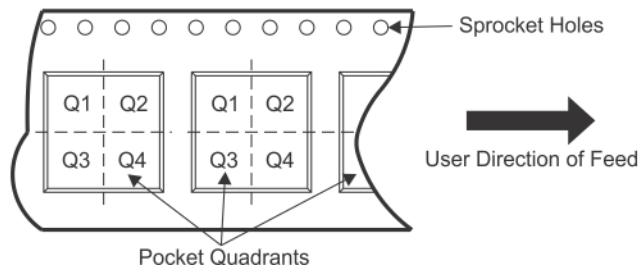
QUADRANT ASSIGNMENTS FOR PIN 1 ORIENTATION IN TAPE

*All dimensions are nominal

| Device | Package Type | Package Drawing | Pins | SPQ | Reel Diameter (mm) | Reel Width W1 (mm) | A0 (mm) | B0 (mm) | K0 (mm) | P1 (mm) | W (mm) | Pin1 Quadrant |
|-------------|--------------|-----------------|------|------|--------------------|--------------------|---------|---------|---------|---------|--------|---------------|
| BQ25970YFFR | DSBGA | YFF | 56 | 3000 | 330.0 | 12.4 | 3.0 | 3.55 | 0.81 | 8.0 | 12.0 | Q1 |
| BQ25970YFFR | DSBGA | YFF | 56 | 3000 | 330.0 | 12.4 | 3.22 | 3.55 | 0.81 | 8.0 | 12.0 | Q1 |
| BQ25970YFFT | DSBGA | YFF | 56 | 250 | 330.0 | 12.4 | 3.22 | 3.55 | 0.81 | 8.0 | 12.0 | Q1 |
| BQ25971YFFR | DSBGA | YFF | 56 | 3000 | 330.0 | 12.4 | 3.0 | 3.55 | 0.81 | 8.0 | 12.0 | Q1 |
| BQ25971YFFT | DSBGA | YFF | 56 | 250 | 330.0 | 12.4 | 3.0 | 3.55 | 0.81 | 8.0 | 12.0 | Q1 |

TAPE AND REEL BOX DIMENSIONS

*All dimensions are nominal

| Device | Package Type | Package Drawing | Pins | SPQ | Length (mm) | Width (mm) | Height (mm) |
|-------------|--------------|-----------------|------|------|-------------|------------|-------------|
| BQ25970YFFR | DSBGA | YFF | 56 | 3000 | 335.0 | 335.0 | 25.0 |
| BQ25970YFFR | DSBGA | YFF | 56 | 3000 | 367.0 | 367.0 | 35.0 |
| BQ25970YFFT | DSBGA | YFF | 56 | 250 | 367.0 | 367.0 | 35.0 |
| BQ25971YFFR | DSBGA | YFF | 56 | 3000 | 335.0 | 335.0 | 25.0 |
| BQ25971YFFT | DSBGA | YFF | 56 | 250 | 335.0 | 335.0 | 25.0 |

YFF0056

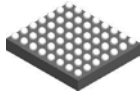

PACKAGE OUTLINE

DSBGA - 0.625 mm max height

DIE SIZE BALL GRID ARRAY

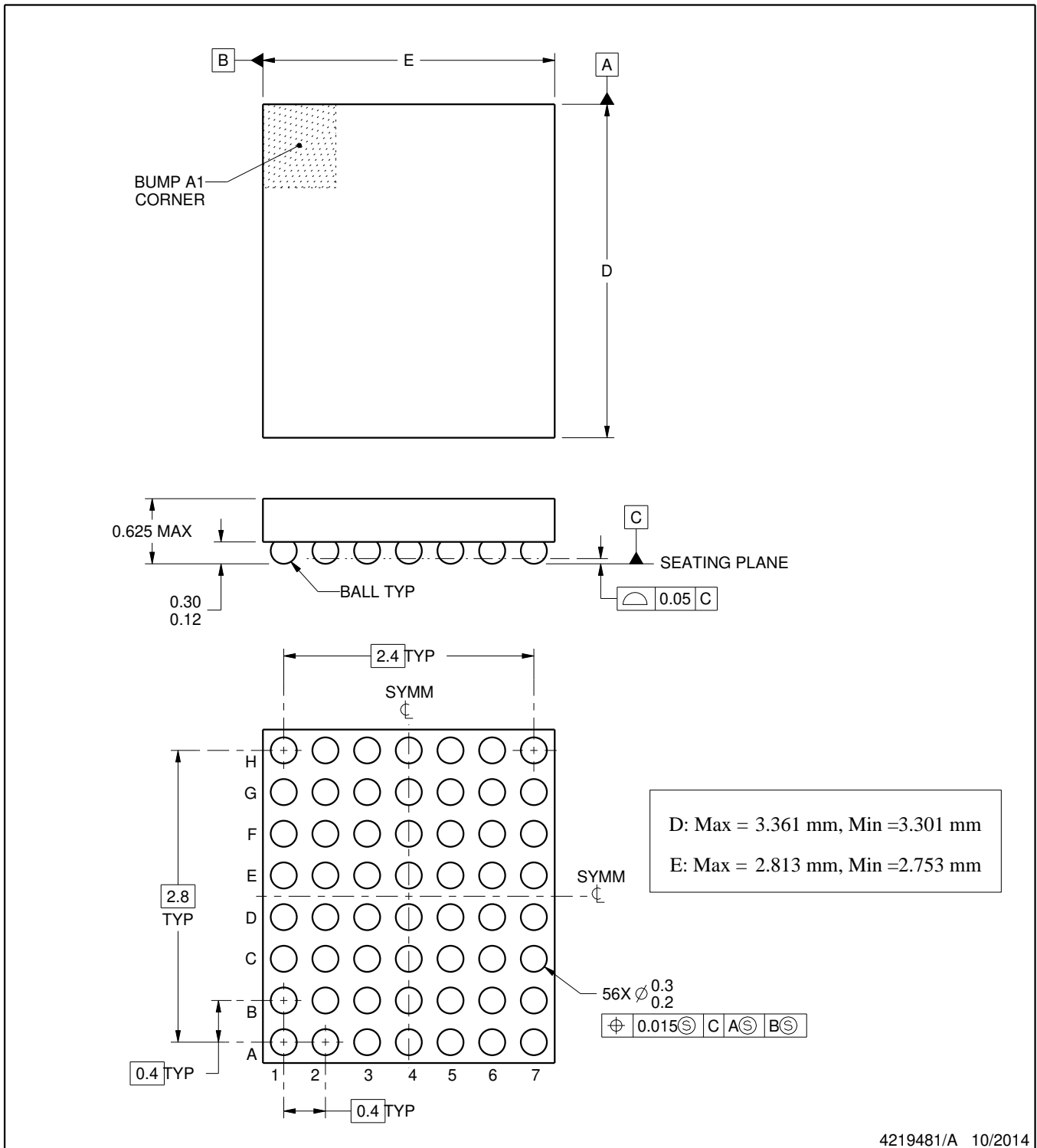

NOTES:

1. All linear dimensions are in millimeters. Any dimensions in parenthesis are for reference only. Dimensioning and tolerancing per ASME Y14.5M.
2. This drawing is subject to change without notice.

EXAMPLE BOARD LAYOUT

YFF0056

DSBGA - 0.625 mm max height

DIE SIZE BALL GRID ARRAY

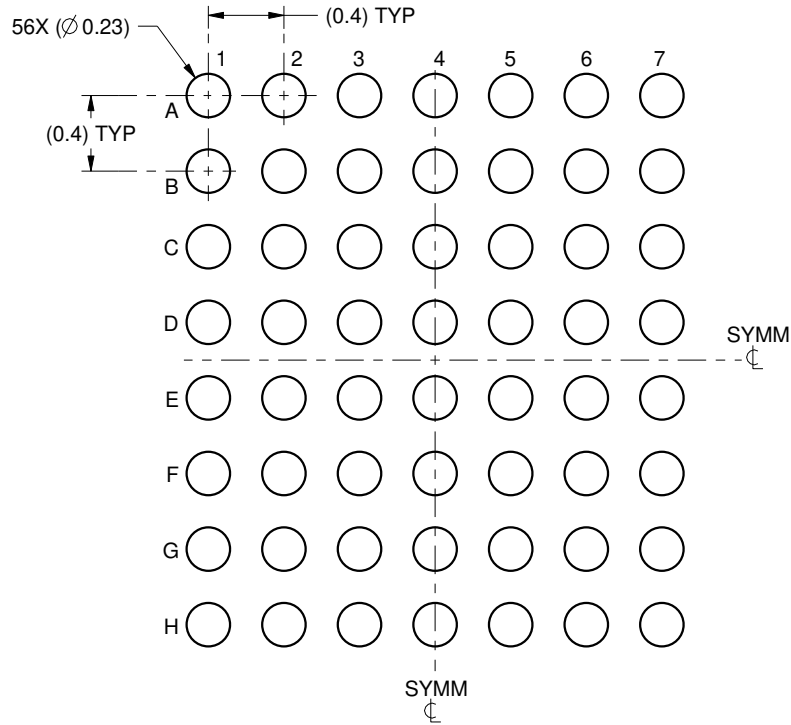

LAND PATTERN EXAMPLE
SCALE:25X

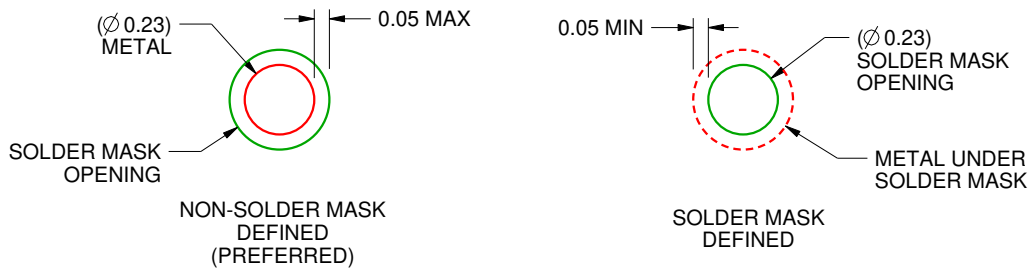

SOLDER MASK DETAILS
NOT TO SCALE

4219481/A 10/2014

NOTES: (continued)

- Final dimensions may vary due to manufacturing tolerance considerations and also routing constraints. For more information, see Texas Instruments literature number SBVA017 (www.ti.com/lit/sbva017).

EXAMPLE STENCIL DESIGN

YFF0056

DSBGA - 0.625 mm max height

DIE SIZE BALL GRID ARRAY

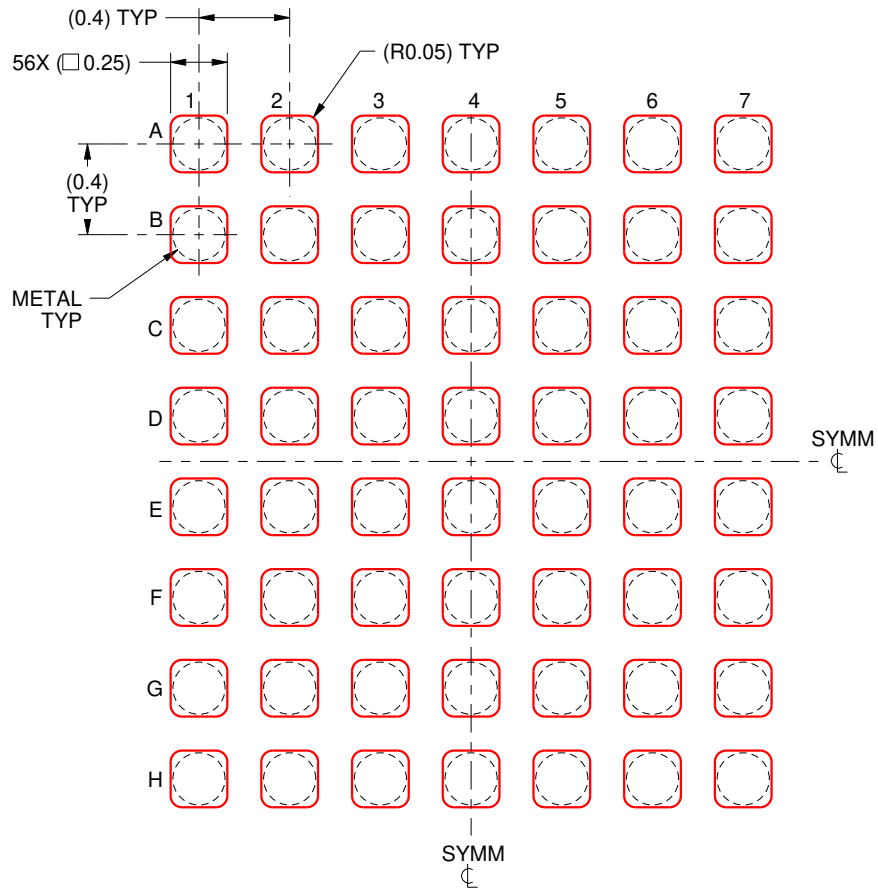

SOLDER PASTE EXAMPLE
BASED ON 0.1 mm THICK STENCIL
SCALE:30X

4219481/A 10/2014

NOTES: (continued)

4. Laser cutting apertures with trapezoidal walls and rounded corners may offer better paste release.

IMPORTANT NOTICE AND DISCLAIMER

TI PROVIDES TECHNICAL AND RELIABILITY DATA (INCLUDING DATA SHEETS), DESIGN RESOURCES (INCLUDING REFERENCE DESIGNS), APPLICATION OR OTHER DESIGN ADVICE, WEB TOOLS, SAFETY INFORMATION, AND OTHER RESOURCES "AS IS" AND WITH ALL FAULTS, AND DISCLAIMS ALL WARRANTIES, EXPRESS AND IMPLIED, INCLUDING WITHOUT LIMITATION ANY IMPLIED WARRANTIES OF MERCHANTABILITY, FITNESS FOR A PARTICULAR PURPOSE OR NON-INFRINGEMENT OF THIRD PARTY INTELLECTUAL PROPERTY RIGHTS.

These resources are intended for skilled developers designing with TI products. You are solely responsible for (1) selecting the appropriate TI products for your application, (2) designing, validating and testing your application, and (3) ensuring your application meets applicable standards, and any other safety, security, regulatory or other requirements.

These resources are subject to change without notice. TI grants you permission to use these resources only for development of an application that uses the TI products described in the resource. Other reproduction and display of these resources is prohibited. No license is granted to any other TI intellectual property right or to any third party intellectual property right. TI disclaims responsibility for, and you will fully indemnify TI and its representatives against, any claims, damages, costs, losses, and liabilities arising out of your use of these resources.

TI's products are provided subject to [TI's Terms of Sale](#) or other applicable terms available either on [ti.com](#) or provided in conjunction with such TI products. TI's provision of these resources does not expand or otherwise alter TI's applicable warranties or warranty disclaimers for TI products.

TI objects to and rejects any additional or different terms you may have proposed.

Mailing Address: Texas Instruments, Post Office Box 655303, Dallas, Texas 75265
Copyright © 2022, Texas Instruments Incorporated