

717 Series Pressure Calibrators

Instruction Sheet

Introduction

The Fluke 717 Series Pressure Calibrators are compact, battery-powered, 5-digit instruments that perform the following calibration and measurement functions:

- Calibrates P/I (pressure to current) transmitters
- Measures pressure using a 1/8-inch NPT pressure fitting and an internal pressure sensor
- Measures pressure via a Fluke 700 Series Pressure Module
- Measures current up to 24 mA
- Sources loop voltage (to 24 V dc)
- Displays simultaneously pressure and current measurements
- Calculates mA percentage in Percent Mode
- Calculates mA error in Percent Error Mode

The 717 Pressure Calibrators (hereafter, “the Calibrator”) include:

- 717 1G
- 717 30G
- 717 100G
- 717 300G
- 717 500G
- 717 1000G
- 717 1500G
- 717 3000G
- 717 5000G

Full Scale Pressure sensor is as listed in the “Specifications” section under “Pressure Specifications”. The Calibrator is an IEC 61010, CAT I 30 V, Pollution Degree 2 instrument. A CAT I instrument is designed to protect against transients from low-energy sources like, for example, electronic circuits or a copy machine.

The Calibrator comes with a holster, an installed 9 V battery, a set of test leads and alligator clips, and a 14-language instruction sheet pack. If the Calibrator is damaged or something is missing, contact the place of purchase immediately.

Input Units

The Calibrator measures and displays pressure sensor inputs in the units listed below:

- Psi
- inH₂O@4°C
- inH₂O@20°C
- cmH₂O@4°C
- cmH₂O@20°C
- bar
- mbar
- kPa
- inHg@0°C
- mmHg
- kg/cm²











If inappropriate units are selected, the output of Fluke 700P pressure modules can be too low to be displayed or can cause the Calibrator to display **OL** (overload).

Refer to Table 1 for pressure unit and range compatibility.

Table 1. Pressure Unit and Range Compatibility

Units	Range	Units	Range
psi	All	kPa	All
inH ₂ O	Through 3000 psi	inHg	All
cmH ₂ O	Through 1000 psi	mmHg	Through 3000 psi
bar	15 psi and above	kg/cm ²	15 psi and above
mbar	Through 1000 psi		

Symbols

Symbol	Meaning
	ON / OFF button
	Earth ground
	Caution: Important information. See instruction sheet
	Hazardous voltage, risk of electric shock
	Pressure
	Double insulated
	Battery
	Canadian Standards Association
	Conforms to European Union requirements
	Direct current

Safety

A "⚠️⚠️ **Warning**" identifies conditions or actions that pose hazards to the user.

A "⚠️ **Caution**" identifies conditions and hazards that may damage the Calibrator or equipment under test.

⚠️⚠️ Warnings

To avoid electric shock, injury, or damage to the Calibrator:

- Use the Calibrator only as described in this Instruction Sheet.
- Using the Calibrator in a manner not specified by the manufacturer might impair the protection provided by the Calibrator.
- Do not use the Calibrator to make measurements in a CAT II, CAT III, or CAT IV environment.

CAT I equipment is designed to protect against transient from high-voltage, low-energy sources, such as electronic circuits or a copy machine.

- Do not use the Calibrator around explosive gas, vapor, or dust.
- Inspect the Calibrator before use. Do not use it if appears damaged.
- Check the test leads for continuity, damaged insulation, or exposed metal. Replace damaged test leads.
- Never apply more than 30 V between any two terminals, or between any terminal and earth ground.
- Use the proper terminals, mode, and range for your measuring or sourcing application.
- To prevent damage to the unit under test, put the Calibrator in the correct mode before connecting the test leads.
- When making connections, connect the COM test lead before the live lead; when disconnecting, disconnect the live lead before the COM lead.
- Never use the Calibrator with the case open.
- Make sure the battery door is closed before you use the Calibrator.
- Replace the battery as soon as the  (low battery) symbol appears to avoid false readings that can lead to electric shock.
- Remove test leads from the Calibrator before opening the case or battery door.
- To avoid a violent release of pressure in a pressurized system, shut off the valve and slowly bleed off the pressure before you attach or detach the pressure sensor or Pressure Module fitting to the pressure line.

When servicing the Calibrator, use only specified replacement parts.

⚠️ Caution

When using pressure pressure modules, to avoid damage to the Calibrator module connections, follow all procedures in the pressure module instruction sheet.

⚠️ Caution

When using pressure sensor connections, to avoid damage to the Calibrator or equipment to which it is attached:

- To avoid overpressure damage, do not apply pressures that exceed ranges listed under "Pressure Specifications".

- To avoid corrosion in the pressure sensor, use the Calibrator only with media compatible with glass, ceramic, silicon, RTV, nitrile (Buna -N) type 303 stainless steel, and nickel.
- To avoid damaging the Calibrator, do not apply torque between the pressure fitting and the Calibrator case. See Figure 1 for the proper technique.

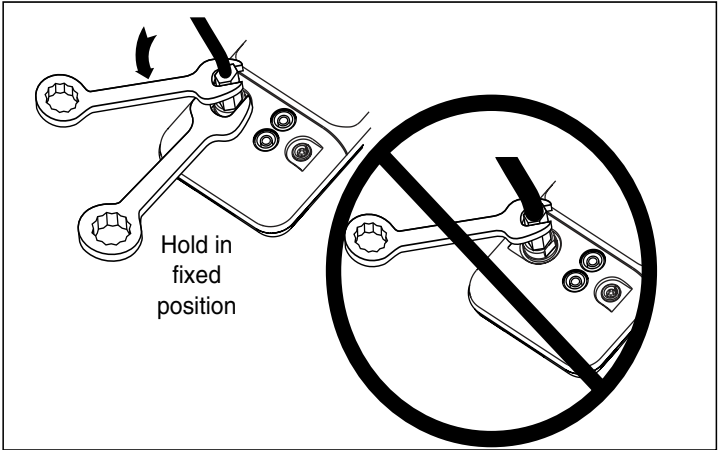

qo001f.eps

Figure 1. Proper Tightening Method

Getting Acquainted

Press \odot to turn the Calibrator ON and OFF. The Calibrator displays pressure and current measurements simultaneously.

The upper part of the display shows the applied pressure.

Press \square_{UNITS} to select a different unit. When you turn the Calibrator OFF, the next time you turn the Calibrator back ON it returns to the pressure unit you last used.

The lower part of the display shows the current (up to 24 mA) applied to the current (mA) inputs. See Figure 2.

Power Saver

The Calibrator automatically turns off after 30 minutes of inactivity. To reduce this time or disable this feature:

1. With the Calibrator OFF, press \odot .
2. **P.S. xx** is displayed, where **xx** is the turn-off time in minutes. **OFF** means the power saver is disabled.
3. Press \square_{HOLD} (\blacktriangledown) to decrease or $\square_{mA\ MODE}$ (\blacktriangle) to increase the turn-off time.
4. To disable, press \square_{HOLD} until the display shows **OFF**.



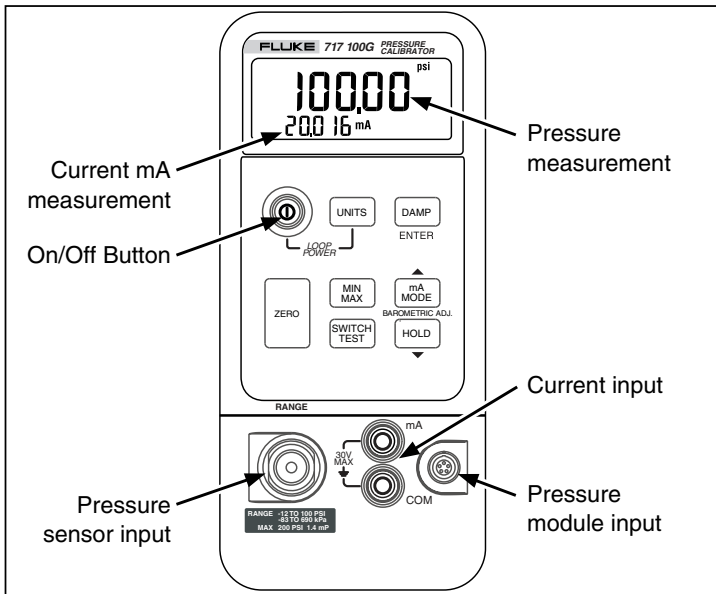







The Calibrator resumes normal operation after 2 seconds.



qq005f.eps

Figure 2. The Pressure Calibrator (717 100G is Shown)

Pushbutton Functions

Button	Function
	Press to select a pressure unit. All units are available when the pressure sensor input is used. For higher pressure module inputs, inappropriate units are not available. Press  on while pressing  to source loop voltage.
	Press to toggle pressure reading damping on and off. With damping on, the display does not update as quickly. Press to confirm selection of 0% and 100% output parameters.
	Press to zero the pressure display. (Vent pressure to atmosphere before pressing.) With an absolute pressure module, see instructions below.
	Press to read the minimum pressure and current readings since power was turned on or the registers were cleared. Press again to read the maximum pressure and current readings since power was turned on. Press and hold to clear the MIN/MAX registers.
	Press to perform switch test.
	Press to toggle the mA display mode between mA, mA Percent, and mA Percent Error.
	Press  to freeze the display. The HOLD symbol appears on the display. Press  again to resume normal operation. In ZERO mode, press to decrease barometric pressure.

Switch Test

To perform a switch test, do the following:

Note

This example uses a normally closed switch. The procedure is the same for an open switch but the display reads OPEN instead of CLOSE.

1. Connect the Calibrator mA and COM terminals to the switch using the pressure switch terminals and connect an external pump between the Calibrator and the pressure switch using a tee fitting. The polarity of the terminals does not matter.
2. Make sure the vent on the pump is open and zero the Calibrator if necessary. Close the vent after zeroing the Calibrator.
3. Press  to enter pressure switch test mode. The Calibrator will display CLOSE instead of a mA measurement.
4. Apply pressure with the pump slowly until the switch opens.

Note

In the switch test mode, the display update rate is increased to help capture changing pressure inputs. Even with the enhanced sample rate, pressuring the device under test should be done slowly to ensure accurate readings.

5. OPEN is displayed once the switch is open. Bleed the pump slowly until the pressure switch closes. The recall icon appears on the display.
6. Press **SWITCH TEST** to read the pressure values for when the switch opened, for when it closed, and for the deadband
7. Hold **SWITCH TEST** for 3 seconds to reset Switch Test mode; hold any other key for 3 seconds to exit.

Zeroing with Absolute Pressure Modules

To zero, adjust the Calibrator to read a known pressure as follows:

1. Press and hold **ZERO**.
2. Press **▲** (**mA MODE**) to increase or **▼** (**HOLD**) to decrease the Calibrator reading to equal the applied pressure.
3. Release **ZERO** to exit the zeroing procedure.

For all but the 700PA3 module, the known pressure can be barometric, if it is accurately known. An accurate pressure standard can also apply a pressure within range for any absolute pressure module. To convert measurement units:

- 1 bar = 750 mmHg (1 mmHg = 0.0013332 bar)
- 1 psi = 2.036 inHg (1 inHg = 0.49115 psi).

Sourcing Loop Voltage

To use the Calibrator to supply loop power (24 V dc) to a current transmitter that is disconnected from the system:

1. With power off, hold down **UNITS** while pressing **Ⓞ ON**. The **LOOP POWER** icon appears on the display.
2. With the transmitter disconnected from normal loop power, connect the Calibrator in series with the instrument current loop as shown in Figure 3.

In addition to mA, the current can be displayed in two alternative modes:

- **Percent Mode-** The current is displayed as a percentage based on a 4-20 mA scale.
 - **Percent Error Mode-** Transmitter current output error is displayed. Error is calculated based on a configurable zero and span pressure and a 4-20 mA scale.
3. Measure loop current in the mA measurement display.
 4. Press **Ⓞ OFF** to deactivate the 24 V dc supply when you are done sourcing loop voltage.

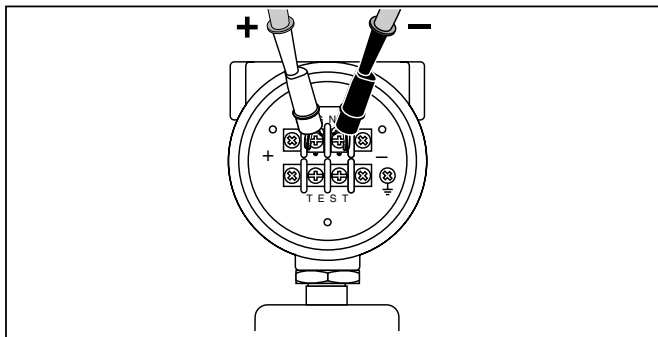

Figure 3. Sourcing Connections

Percent Error Setup

Press and hold $\boxed{\text{mA MODE}}$. After 3 seconds the set icon and 0% appears on the lower display. Use \blacktriangledown and \blacktriangle to adjust the 0% point for the Percent Error calculation, then press $\boxed{\text{DAMP}}$ (ENTER) key to confirm selection. Press $\boxed{\text{mA MODE}}$. 100% is displayed on the lower display. Use \blacktriangledown and \blacktriangle to adjust the 100% point for the Percent Error calculation. Press $\boxed{\text{DAMP}}$ (ENTER) to confirm the selection and exit.

Calibrating a P/I Transmitter

To calibrate a P/I (pressure to current) transmitter:

1. Open the pump vent and zero the Calibrator before applying pressure. Repeat frequently to ensure accuracy.
2. Apply a pressure to the transmitter and measure the transmitter's current loop output. **OL** (overload) is displayed at full scale.
3. Connect the Calibrator to the transmitter as shown in Figure 4 or Figure 5. The Calibrator recognizes only the pressure module if both types of connection are in place.

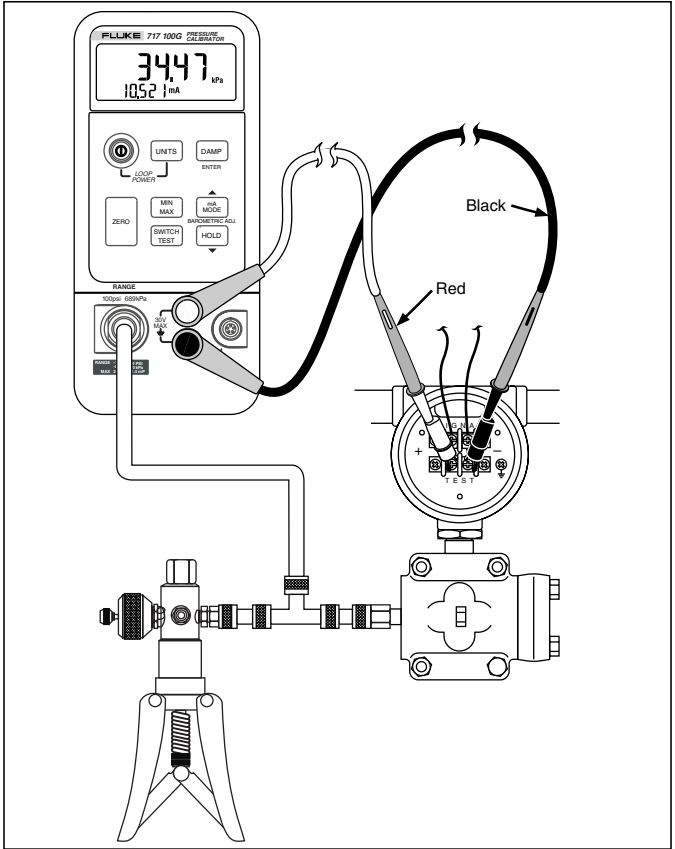

qq002f.eps

Figure 4. Connecting to an Internal Pressure Sensor

Calibrating a P/I Transmitter (Cont.)

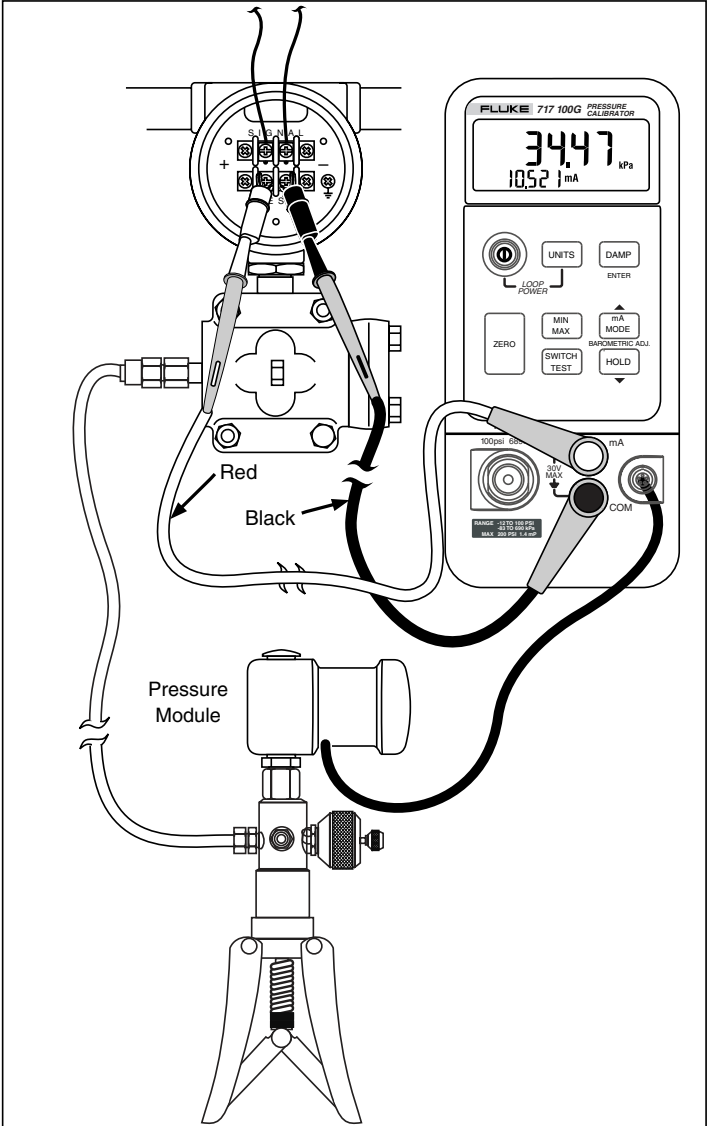

Figure 5. Connecting to a Pressure Module

Maintenance

Warning

To avoid electric shock, personal injury, or damage to the Calibrator:

- Do not service this product other than as described in this Instruction Sheet unless you are a qualified technician and have the required equipment and service information.
- Remove any input signals prior to removing test leads and opening case.
- When servicing the Calibrator, use only specified replacement parts.
- Do not allow water to get in the case.

For maintenance procedures not described in this Instruction Sheet, contact a Fluke Service Center.

In Case of Difficulty

- Check the battery, test leads, and pressure tubing. Replace as necessary.
- Review this Instruction Sheet to make sure you are using the Calibrator correctly.

If the Calibrator needs repair, and the Calibrator is under warranty, see the warranty statement for terms. If the warranty has lapsed, the Calibrator will be repaired and returned for a fixed fee.

Cleaning

Periodically wipe the case with a damp cloth and detergent; do not use abrasives or solvents.

Calibration

Calibrate your Calibrator yearly to ensure that it performs to specification. A Calibration Manual (Fluke PN 686540) is available.

Replacing the Battery

Warning

To avoid false readings, which could lead to electric shock or injury, replace the battery as soon as  (low battery indicator) appears on the display.

Use only a single 9 V battery, properly installed, to power the Calibrator.

The Calibrator uses a single 9 V, alkaline battery (ANSI/NEDA 1604A or IEC 6LR61).

To replace the battery (see Figure 5):

1. Turn the Calibrator OFF and remove the test leads from the terminals.
2. Remove Calibrator from its holster.
3. Remove the battery door on the back of the Calibrator as shown.
4. Lift the battery from the battery receptacle.
5. Attach the replacement battery to the leads, place the battery back in the battery receptacle.
6. Secure the battery door.
7. Return the Calibrator to its holster.

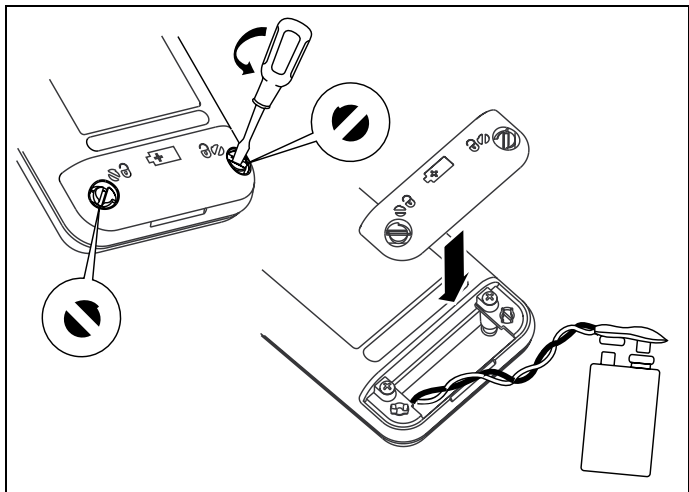

it071.eps

Figure 6. Battery Installation

Replacement Parts and Accessories

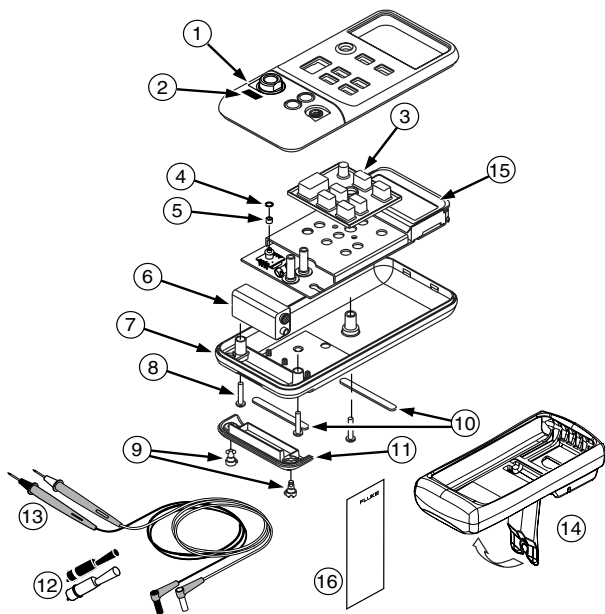

qo004f.eps

Item	Part or Accessory	No.	Qty
①	717 case top for 300G and below	2546258	1
①	717 case top for 500G and above	2546264	1
②	717 1G Top Case Decal	2546993	1
②	717 30G Top Case Decal	2547000	1
②	717 100G Top Case Decal	2547017	1
②	717 300G Top Case Decal	2547021	1
②	717 500G Top Case Decal	2547039	1
②	717 1000G Top Case Decal	2547042	1
②	717 1500G Top Case Decal	2547056	1
②	717 3000G Top Case Decal	2547063	1
②	717 5000G Top Case Decal	2547074	1
③	Keypad	2113087	1
④	Spacer for pressure input	687449	1
⑤	O-ring for pressure input	146688	1
⑥	9 V battery, ANSI / NEDA 1604A or IEC LR61	614487	1
⑦	Case bottom	2397526	1

Figure 7. Replacement Parts and Accessories

Item	Part or Accessory	No.	Qty
⑧	Case screw	832246	3
⑨	Battery door fasteners	948609	2
⑩	Non-skid foot	824466	2
⑪	Battery door	609930	1
⑫	Alligator clips	AC72	1
⑬	Test lead set	TL75	1
⑭	Holster, Yellow	2074033	1
⑮	717 30G LCD Bezel	663997	1
⑯	717 100G LCD Bezel	1638728	1
⑰	717 300G LCD Bezel	2545073	1
⑰	717 500G LCD Bezel	2545099	1
⑰	717 1000G LCD Bezel	2545105	1
⑰	717 1500G LCD Bezel	2545110	1
⑰	717 3000G LCD Bezel	2545122	1
⑰	717 5000G LCD Bezel	2545131	1
⑰	717 1G LCD Bezel	2545064	1
⑰	Instruction sheets (14)	690013	--

Figure 7. Replacement Parts and Accessories (cont.)

Specifications

Accuracy is specified for 1 year after calibration at operating temperatures of -10°C to $+55^{\circ}\text{C}$.

Pressure Specifications

Model	Range SI	Range Metric	Max SI	Max Metric
717-1G	(-1 to 1) PSI	(-7 to 7) kPa	5 PSI	34.5 kPa
717-30G	(-12 to 30) PSI	(-83 to 207) kPa	60 PSI	413 kPa
717-100G	(-12 to 100) PSI	(-83 to 690) kPa	200 PSI	1379 kPa or 1.4 mPa
717-300G	(-12 to 300) PSI	(-83 to 2068) kPa or 2.1 mPa	375 PSI	2586 kPa or 2.6 mPa
717-500G	(0 to 500) PSI	3447 kPa or 3.4 mPa	1000 PSI	6895 kPa or 6.9 mPa
717-1000G	(0-1000) PSI	6895 kPa or 6.9 mPa	2000 PSI	13790 kPa or 13.8 mPa
717-1500G	(0-1500) PSI	10342 kPa or 10.3 mPa	3000 PSI	20684 kPa or 20.7 mPa

Pressure Specifications (cont.)

Model	Range SI	Range Metric	Max SI	Max Metric
717-3000G	(0-3000) PSI	20684 kPa or 20.7 mPa	6000 PSI	41369 kPa or 41.4 mPa
717-5000G	(0-5000) PSI	34474 kPa or 34.5 mPa	10000 PSI	68948 kPa or 69 mPa

Accuracy: Pressure Accuracy is +/- 0.05% of range

Temperature coefficient:

0.01 % of range per °C for temperature ranges of between -10 °C to 18 °C and 28 °C to 55 °C.

Pressure Display, Pressure Module Input

Range	Resolution	Accuracy
Refer to the Instruction Sheet for the pressure module		

DC mA Input

Range	Resolution	Accuracy, ± (% of Reading + Counts)
24 mA	0.001 mA	0.015 + 2

Overload protection:

Fuseless overvoltage protection

Temperature coefficient:

0.005 % of range per °C for temperature ranges of between -10 °C to 18 °C and 28 °C to 55 °C.

Loop Supply

24 V dc nominal

General Specifications

Maximum voltage applied between either an mA terminal and earth ground or between the mA terminals:

30 V

Storage temperature:

-40 °C to 60 °C

Operating temperature:

-10 °C to 55 °C

Operating altitude:

3000 meters maximum

Relative humidity:

95 % up to 30 °C;

75 % up to 40 °C;

45 % up to 50 °C;

35 % up to 55 °C

Vibration:

Random 2 g, 5 Hz to 500 Hz, per MIL -PRF_28800F, Class 2

Shock:

1 meter drop, per IEC 61010-1

Safety Compliance:

IEC 61010-1 2nd Edition CAT I, 30 V; Pollution Degree 2
CSA C22.2 No. 1010.1;
ANSI/ISA S82.02. Maximum Transient Overvoltage: 240 VAC for 10
Seconds.

CE:

Complies with EN 61326 Class A; EN61010-1

Protection Class: Class II, Double Insulated

Power requirements:

Single 9 V battery (ANSI/NEDA 1604A or IEC 6LR61)

Size:

34.9 mm H x 87 mm W x 187 mm L

(1.55 in H x 3.41 in W x 7.35 in L);

With holster and Flex-Stand: 52 mm H x 98 mm W x 201 mm L (2.06 in H x
3.86 in W x 7.93 in L)

Weight:

369 g (13 oz);

With holster and Flex-Stand: 624 g (22 oz)

Contacting Fluke

To contact Fluke for product information, operating assistance, service, or to get the location of the nearest Fluke distributor or service center, call:

USA: 1-888-99-FLUKE (1-888-993-5853)

Canada: 1-800-36-FLUKE (1-800-363-5853)

Europe: +31 402-675-200

Japan: +81-3-3434-0181

Singapore: +65-738-5655

Anywhere in the world: +1-425-446-5500

Or visit Fluke's web site at: www.fluke.com.

Register your Calibrator at: <http://register.fluke.com>.

Address correspondence to:

Fluke Corporation
P.O. Box 9090,
Everett, WA 98206-9090
U.S.A.

Fluke Europe B.V.
P.O. Box 1186,
5602 BD Eindhoven
The Netherlands

Limited Warranty & Limitation Of Liability

This Fluke product will be free from defects in material and workmanship for 3 years from the date of purchase. This warranty does not cover fuses, disposable batteries, or damage from accident, neglect, misuse, alteration, contamination, or abnormal conditions of operation or handling. Resellers are not authorized to extend any other warranty on Fluke's behalf. To obtain service during the warranty period, contact your nearest Fluke authorized service center to obtain return authorization information, then send the product to that Service Center with a description of the problem.

THIS WARRANTY IS YOUR ONLY REMEDY. NO OTHER WARRANTIES, SUCH AS FITNESS FOR A PARTICULAR PURPOSE, ARE EXPRESSED OR IMPLIED. FLUKE IS NOT LIABLE FOR ANY SPECIAL, INDIRECT, INCIDENTAL OR CONSEQUENTIAL DAMAGES OR LOSSES, ARISING FROM ANY CAUSE OR THEORY. Since some states or countries do not allow the exclusion or limitation of an implied warranty or of incidental or consequential damages, this limitation of liability may not apply to you.