



3 dB Fixed Attenuator, 1.85mm Male to 1.85mm Female Passivated Stainless Steel Body Rated to 1 Watt Up to 65 GHz

RF Fixed Attenuators Technical Data Sheet

PE7403-3

Features

- DC to 65 GHz Frequency Range
- Attenuation 3 ± 1.5 dB
- Max Power 1 Watt (CW)
- VSWR < 1.65:1

Applications

- Instrumentation
- Precision measurements
- Prototyping and characterization
- Production systems

Description

Pasternack carries a wide range of fixed attenuators with a broad selection of attenuation levels, frequency ranges, and power dissipation ranges. RF microwave attenuators (also known as RF pads) lower the amplitude of a signal (attenuate) a known amount and can be used in a wide variety of applications. These attenuator pads are used when a signal needs to be reduced to protect measurement equipment or other circuitry, to extend the range of power meters and amplifiers, and to impedance match circuits by reducing the VSWR seen by adjacent components. RF attenuators can prevent signal overload in amplifiers, receivers and detectors, adjusting the signal level to a range that is optimal.

Few RF components are as commonly used as fixed coaxial attenuators, and Pasternack carries one of the largest in-stock varieties and ships them same day. The 3 dB Fixed Attenuator PE7403-3 is rated to 1 Watt and operates from DC to 65 GHz. The versatile coaxial package uses 1.85mm male to 1.85mm female connectors and is also REACH and RoHS compliant.

Electrical Specifications

Description	Minimum	Typical	Maximum	Units
Frequency Range	DC		65	GHz
Impedance		50		Ohms
Nominal Attenuation		3		dB
VSWR			1.65:1	
Input Power, CW derated linearly to 0.1W at +100°C			1	Watt

Specifications by Frequency

Description	F1	F2	F3	F4	F5	Units
Range	DC to 26.5	26.5 to 40	40 to 60	60 to 65		GHz
VSWR, Max	1.35:1	1.55:1	1.65:1	1.65:1		
Attenuation Accuracy, Typ	0.75	1	1.5	1.5		dB

Click the following link (or enter part number in "SEARCH" on website) to obtain additional part information including price, inventory and certifications: [3 dB Fixed Attenuator, 1.85mm Male to 1.85mm Female Passivated Stainless Steel Body Rated to 1 Watt Up to 65 GHz PE7403-3](#)



3 dB Fixed Attenuator, 1.85mm Male to 1.85mm Female
Passivated Stainless Steel Body Rated to 1 Watt Up to 65 GHz

RF Fixed Attenuators Technical Data Sheet

PE7403-3

Mechanical Specifications

Size

Length	0.88 in [22.35 mm]
Weight	0.01 lbs [4.54 g]
Body Material and Plating	Passivated Stainless Steel

Configuration

Design	Fixed
Package Style	Connectorized Module

Connectors

Description	Connector 1	Connector 2
Type	1.85mm Male	1.85mm Female
Contact Material and Plating	Beryllium Copper, Gold	Beryllium Copper, Gold
Contact Plating Specification	MIL-PRF-39012	MIL-PRF-39012
Coupling Nut Material and Plating	Passivated Stainless Steel	
Body Material and Plating	Passivated Stainless Steel	Passivated Stainless Steel

Mechanical Specification Notes:

The connectors use high temperature plastic bead dielectric.

Environmental Specifications

Temperature

Operating Range	-55 to +100 deg C
Storage Range	-55 to +100 deg C

Compliance Certifications (see [product page](#) for current document)

Plotted and Other Data

Notes:

3 dB Fixed Attenuator, 1.85mm Male to 1.85mm Female Passivated Stainless Steel Body Rated to 1 Watt Up to 65 GHz from Pasternack Enterprises has same day shipment for domestic and International orders. Our RF, microwave and millimeter wave products maintain a 99.4% availability and are part of the broadest selection in the industry.

Click the following link (or enter part number in "SEARCH" on website) to obtain additional part information including price, inventory and certifications: [3 dB Fixed Attenuator, 1.85mm Male to 1.85mm Female Passivated Stainless Steel Body Rated to 1 Watt Up to 65 GHz PE7403-3](#)

URL: <https://www.pasternack.com/3db-fixed-1.85mm-male-1.85mm-female-1-watt-attenuator-pe7403-3-p.aspx>

PE7403-3 CAD Drawing

3 dB Fixed Attenuator, 1.85mm Male to 1.85mm Female Passivated
Stainless Steel Body Rated to 1 Watt Up to 65 GHz

REVISIONS			
REV.	DESCRIPTION	DATE	APPROVED
B	PE7403-10 SA6510-10 20220429	6/7/2022	S. PONG

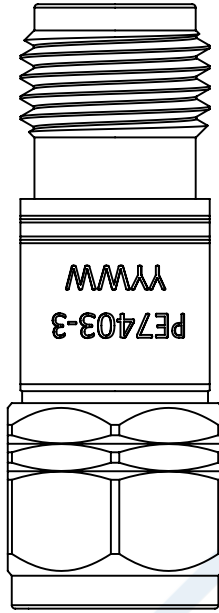
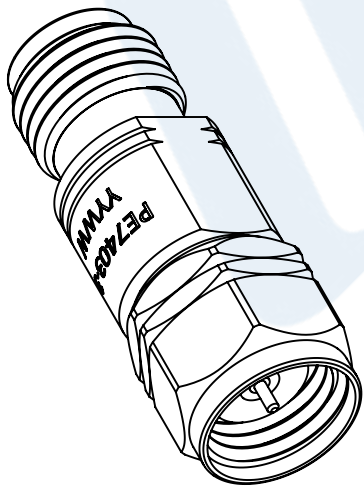

1.85mm MALE

1.85mm FEMALE

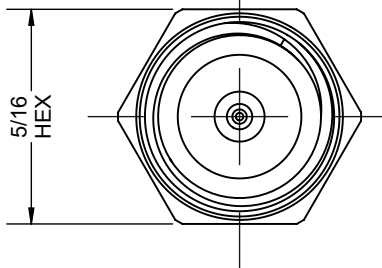
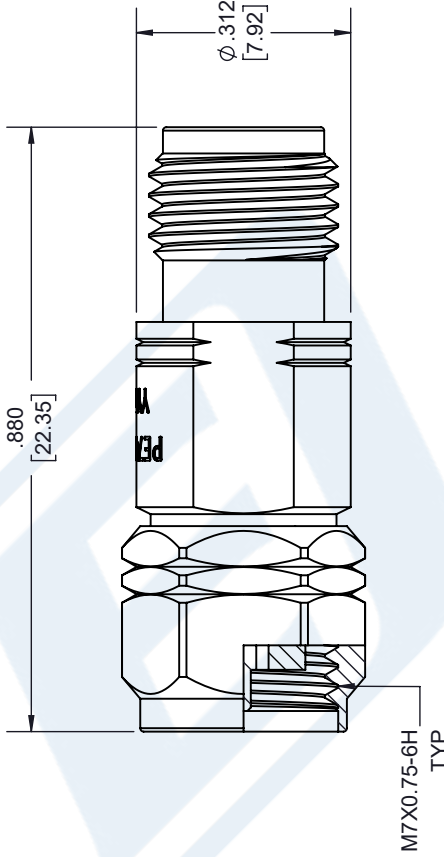

UNLESS OTHERWISE SPECIFIED
LEADING DIMENSIONS ARE INCHES
DIMENSIONS IN [] ARE MILLIMETERS

TOLERANCES:
 .X = ±.2 [5.08] FRACTIONS ± 1/32
 .XX = ±.02 [.51] ANGLES ± 1°
 .XXX = ±.005 [.13]

CABLE LENGTH (L), TOLERANCES:
 L ≤ 12 [305] = +1 [25] / -0
 12 [305] < L ≤ 60 [1524] = +2 [51] / -0
 60 [1524] < L ≤ 120 [3048] = +4 [102] / -0
 120 [3048] < L ≤ 300 [7620] = +6 [152] / -0
 300 [7620] < L = +5% / -0

ALL DIMENSIONS SHOWN
ARE FOR REFERENCE ONLY.

PE PASTERNAK
an INFINITE brand

Pasternack Enterprises, Inc.
P.O. Box 16759, Irvine, CA 92623.
Phone: 1.949.261.1920 | 1.866.727.8376
Fax: 1.949.261.7451
Website: www.pasternack.com
E-mail: sales@pasternack.com

SIZE [CAGE CODE] DRAWN BY ITEM NO.
A 53919 K.DANG PE7403-3

THIRD-ANGLE PROJECTION

THE INFORMATION AND
DESIGN IN THIS DOCUMENT
IS THE PROPERTY OF
PASTERNAK CORPORATION
ALL RIGHTS RESERVED.

SHEET 1 OF 1

SCALE N/A

REV B