

Energy Management Multifunction indicator Type WM12-96

CARLO GAVAZZI



- Accuracy ± 0.5 F.S. (current/voltage)
- Multifunction indicator
- Display of instantaneous variables: 3x3 digit
- Variable system and phase measurements: W, W_{dmd} , var, VA, VA_{dmd} , PF, V, A, An, Hz
- A_{max} , $W_{dmd\ max}$ indication
- TRMS meas. of distorted sine waves (voltages/currents)
- Power supply: 24V, 48V, 115V, 230V, 50-60Hz; 18 to 60VDC
- Protection degree (front): IP65
- Front dimensions: 96x96mm
- Optional RS422/485 serial output
- Alarms (visual only) V_{LN} , An

Product Description

3-phase multifunction power indicator with built-in programming key-pad. Particularly recommended for displaying the main electrical variables.

Housing for panel mounting, (front) protection degree IP65 as standard, and optional RS485 serial output.

How to order

WM12-96 AV5 3 D X

Model _____
 Range code _____
 System _____
 Power supply _____
 Option _____

Type Selection

Range codes	System	Power supply	Options
AV5: 380/660 V_{L-L} /5(6)AAC VL-N: 185 V to 460 V VL-L: 320 V to 800 V AV6: 120/208 V_{L-L} /5(6)AAC VL-N: 45 V to 145 V VL-L: 78 V to 250 V Phase current: 0.03A to 6A Neutral current: 0.09 to 6A	3: 1-2-3-phase, unbalanced load, with or without neutral	A: 24VAC -15+10%, 50-60Hz B: 48VAC -15+10%, 50-60Hz C: 115VAC -15+10%, 50-60Hz D: 230VAC -15+10%, 50-60Hz 3: 18 to 60VDC	X: None S: RS485 output

Input specifications

Rated inputs Current Voltage	3 (shunt) 4	Sampling rate 1400 samples/s @ 50Hz 1700 samples/s @ 60Hz
Accuracy (display, RS485) (@25°C $\pm 5^\circ\text{C}$, R.H. $\leq 60\%$)	with CT=1 and VT=1 AV5: 1150W-VA-var, FS:230VLN, 400VLL; AV6: 285W-VA-var, FS:57VLN, 100VLL	Display refresh time 700ms
Current Neutral current Phase-phase voltage Phase-neutral voltage Active and Apparent power, Power factor Reactive power	0.25 to 6A: $\pm(0.5\% \text{ FS} + 1\text{DGT})$ 0.03A to 0.25A: $\pm 7\text{DGT}$ 0.25 to 6A: $\pm(1.5\% \text{ FS} + 1\text{DGT})$ 0.09A to 0.25A: $\pm 7\text{DGT}$ $\pm(1.5\% \text{ FS} + 1 \text{ DGT})$ $\pm(0.5\% \text{ FS} + 1 \text{ DGT})$	Display Type Read-out for the instant. var. LED, 14mm 3x3 DGT
Frequency	0.25 to 6A: $\pm(2\% \text{ FS} + 1\text{DGT})$; 0.03A to 0.25A: $\pm(2\% \text{ FS} + 5\text{DGT})$ $\pm 0.1\% \text{ Hz}$ (48 to 62Hz)	Measurements Current, voltage, power, power factor, frequency TRMS measurement of distorted waves. Direct < 3, max 10A peak
Additional errors Humidity	$\leq 0.3\% \text{ FS}$, 60% to 90% RH	Input impedance 380/660 V_{L-L} (AV5) 120/208 V_{L-L} (AV6) Current 1 M Ω $\pm 5\%$ 453 K Ω $\pm 5\%$ $\leq 0.02\Omega$
Temperature drift	$\leq 200\text{ppm}/^\circ\text{C}$	Frequency 48 to 62 Hz
		Overload protection Continuous voltage/current For 500ms: voltage/current 1.2 F.S. 2 Un/36A



RS485 Serial Output Specifications

RS422/RS485 (on request)		Data (bidirectional) Dynamic (reading only) Static (writing only)	System and phase variables All configuration parameters 1 bit di start , 8 data bit, no parity, 1 stop bit 9600 bit/s
Type	Multidrop bidirectional (static and dynamic variables)	Data format	
Connections	2 or 4 wires, max. distance 1200m, termination directly on the instrument	Baud-rate	
Addresses Protocol	1 to 255, key-pad selectable MODBUS/JBUS		

Software functions

Password	Numeric code of max. 3 digits; 2 protection levels of the programming data Password "0", no protection	Displaying 3-phase system with neutral	Up to 3 variables per page Page 1: V L1, V L2, V L3 Page 2: V L12, V L23, V L31 Page 3: A L1, A L2, A L3 Page 4: An Page 5: W L1, W L2, W L3 Page 6: PF L1, PF L2, PF L3 Page 7: var L1, var L2, var L3 Page 8: VA L1, VA L2, VA L3 Page 9: VA Σ , W Σ , var Σ Page 10: VA dmd, W dmd, Hz Page 11: Wdmd MAX Page 12: VL-L Σ , PF Σ Page 13: A MAX
1st level	Password "0", no protection		
2nd level	Password from 1 to 999, all data are protected		
System selection	3-phase with neutral 3-phase without neutral 3-phase ARON 2-phase Single phase		
Transformer ratio			
CT	1 to 999		
VT	1.0 to 99.9		
Filter		Alarms	
Operating range	0 to 99.9% of the input electrical scale	Programmable, for the VL Σ and An (neutral current). Note: the alarm is only visual, by means of LED on the front of the instrument.	
Filtering coefficient	1 to 16		
Filter action	Measurements, alarms, serial output (fundamental variables: V, A, W and their derived ones).	Reset	
		Independent alarm (VL Σ , An) max: A, Wdmd	

Power Supply Specifications

Auxiliary power supply	230VAC -15 +10%, 50-60Hz 115VAC -15 +10%, 50-60Hz 48VAC -15 +10%, 50-60Hz	Power consumption	24VAC -15 +10%, 50-60Hz 18 to 60VDC AC: 4.5 VA DC: 4W
-------------------------------	--	--------------------------	---

General Specifications

Operating temperature	-5 to +50°C (23 to 122°F) (RH < 90% non condensing at 40°C)	RS485.	500VAC/DC between measuring inputs and
Storage temperature	-30 to +60°C (-22 to 140°F) (RH < 90% non condensing at 40°C)		4000VAC, 500VDC between power supply and RS485
Installation category	Cat. III (IEC 60664, EN60664)	Dielectric strength	4000 VAC (for 1 min)
Insulation (for 1 minute)	4000VAC, 500VDC between measuring inputs and power supply.	EMC Emissions	EN50084-1 (class A) residential environment,

General Specifications (cont.)

Immunity	commerce and light industry EN61000-6-2 (class A) industrial environment.	Dimensions (WxHxD) Material	96 x 96 x 63 mm ABS self-extinguishing: UL 94 V-0
Pulse voltage (1.2/50µs)	EN61000-4-5	Mounting	Panel
Safety standards	IEC60664, EN60664	Protection degree	Front: IP65 (standard), NEMA4x, NEMA12 Connections: IP20
Approvals	CE, cULus	Weight	Approx. 400 g (pack. incl.)
Connections 5(6) A Max cable cross sect. area	Screw-type 2.5 mm ²		
Housing			

Waveform of the signals that can be measured

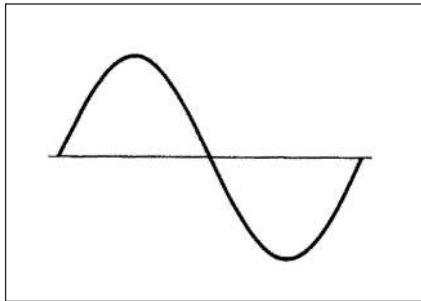

Figure A

Sine wave, undistorted

Fundamental content	100%
Harmonic content	0%
$A_{rms} =$	$1.1107 A $

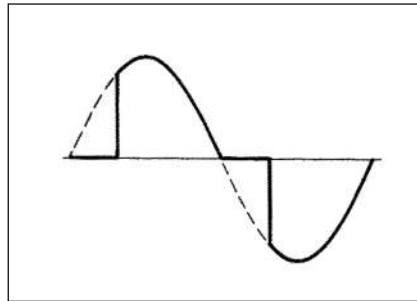

Figure B

Sine wave, indented

Fundamental content	10...100%
Harmonic content	0...90%
Frequency spectrum:	3rd to 16th harmonic
Additional error:	<1% FS

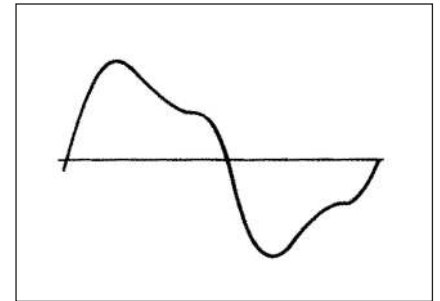

Figure C

Sine wave, distorted

Fundamental content	70...90%
Harmonic content	10...30%
Frequency spectrum:	3rd to 16th harmonic
Additional error:	<0.5% FS

Display pages

Display variables in 3-phase systems (in a 3-phase system with neutral)

No	1 st variable	2 nd variable	3 rd variable	Note
1	V L1	V L2	V L3	
2	V L12	V L23	V L31	Decimal point blinking on the right of the display
3	A L1	A L2	A L3	
4	An	AL.n		AL.n if neutral current alarm is active
5	W L1	W L2	W L3	Decimal point blinking on the right of the display if generated power
6	PF L1	PF L2	PF L3	
7	VAR L1	VAR L2	VAR L3	Decimal point blinking on the right of the display if generated power
8	VA L1	VA L2	VA L3	
9	VA system	W system	VAR system	
10	VA dmd (system)	W dmd (system)	Hz (system)	dmd = demand (integration time selectable from 1 to 30 minutes)
11		W dmd MAX		Maximum sys power demand
12	V LL system	AL.U	PF system	AL.U= is activated only if one of VLN is not within the set limits
13	A MAX			max. current among the three phases

Used calculation formulas

Phase variables

Instantaneous effective voltage

$$V_{IN} = \sqrt{\frac{1}{n} \cdot \sum_1^n (V_{IN})_i^2}$$

Instantaneous active power

$$W_1 = \frac{1}{n} \cdot \sum_1^n (V_{IN})_i \cdot (A_1)_i$$

Instantaneous power factor

$$\cos\phi_1 = \frac{W_1}{VA_1}$$

Instantaneous effective current

$$A_1 = \sqrt{\frac{1}{n} \cdot \sum_1^n (A_1)_i^2}$$

Instantaneous apparent power

$$VA_1 = V_{IN} \cdot A_1$$

Instantaneous reactive power

$$VAR_1 = \sqrt{(VA_1)^2 - (W_1)^2}$$

System variables

Equivalent 3-phase voltage

$$V_{\Sigma} = \frac{V_1 + V_2 + V_3}{3} \cdot \sqrt{3}$$

3-phase reactive power

$$VAR_{\Sigma} = (VAR_1 + VAR_2 + VAR_3)$$

3-phase active power

$$W_{\Sigma} = W_1 + W_2 + W_3$$

3-phase apparent power

$$VA_{\Sigma} = \sqrt{W_{\Sigma}^2 + VAR_{\Sigma}^2}$$

3-phase power factor

$$\cos\phi_{\Sigma} = \frac{W_{\Sigma}}{VA_{\Sigma}}$$

Neutral current

$$An = \overline{A_{L1}} + \overline{A_{L2}} + \overline{A_{L3}}$$

F1= 315mA

Wiring diagrams

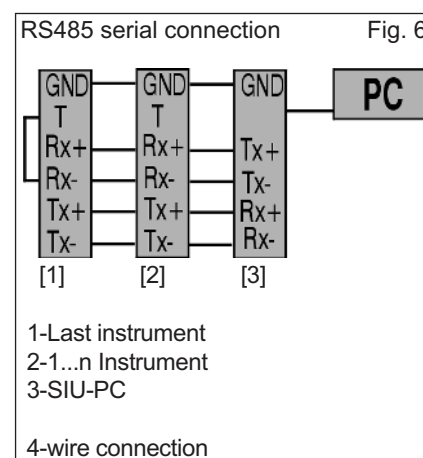
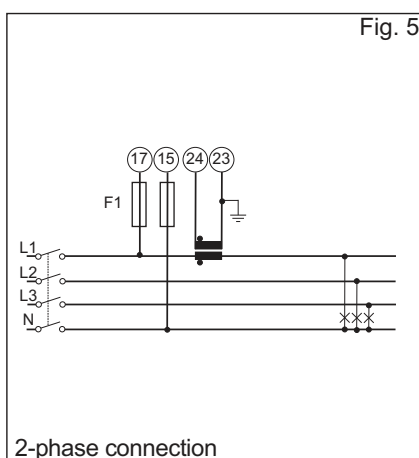
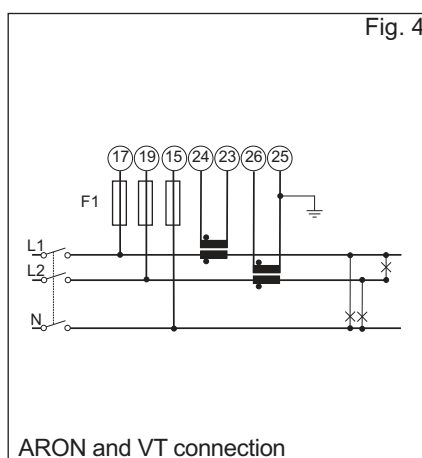
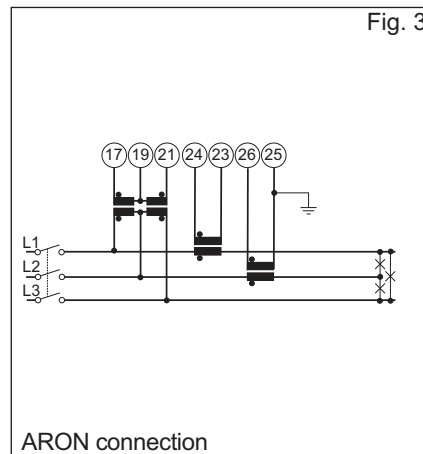
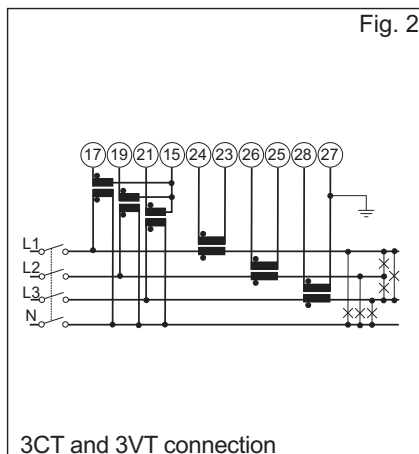
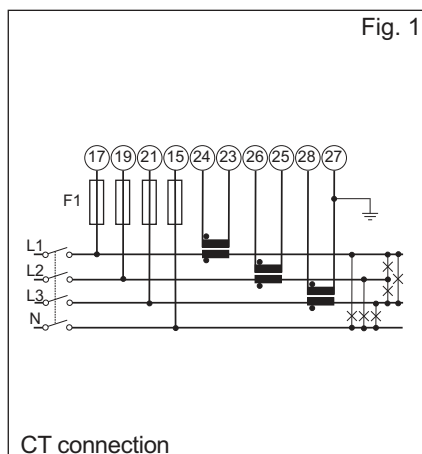

NOTE: the current inputs can be connected to the lines ONLY by means of current transformers. The direct connection is not allowed.

ATTENTION: Only one ammeter input can be connected to earth, as shown in the electrical diagrams.

Front Panel Description

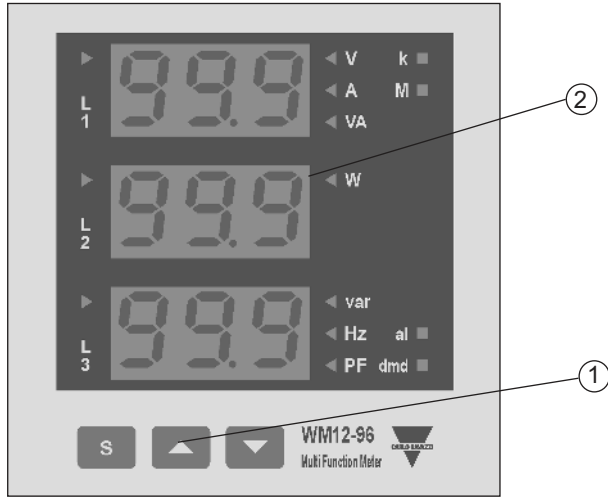

1. Key-pad

To program the configuration parameters and the display of the variables.



Key to enter programming and confirm selections;



Keys to:

- programme values;
- select functions;
- display measuring pages.

2. Display

LED-type with alphanumeric indications to:

- display configuration parameters;
- display all the measured variables.

Dimensions and Panel Cut-out

