

1394430-1 ✓ ACTIVE



MAG-MATE

TE Internal #: 1394430-1

Magnet Wire Terminals, RAST 5D, 28 – 25 AWG Aluminum Wire, .08 – .16 mm Aluminum Wire, .27 – .4 mm Magnet Wire, 30 – 26 AWG Magnet Wire, MAG-MATE

[View on TE.com >](#)

Terminals & Splices > Magnet Wire Terminals

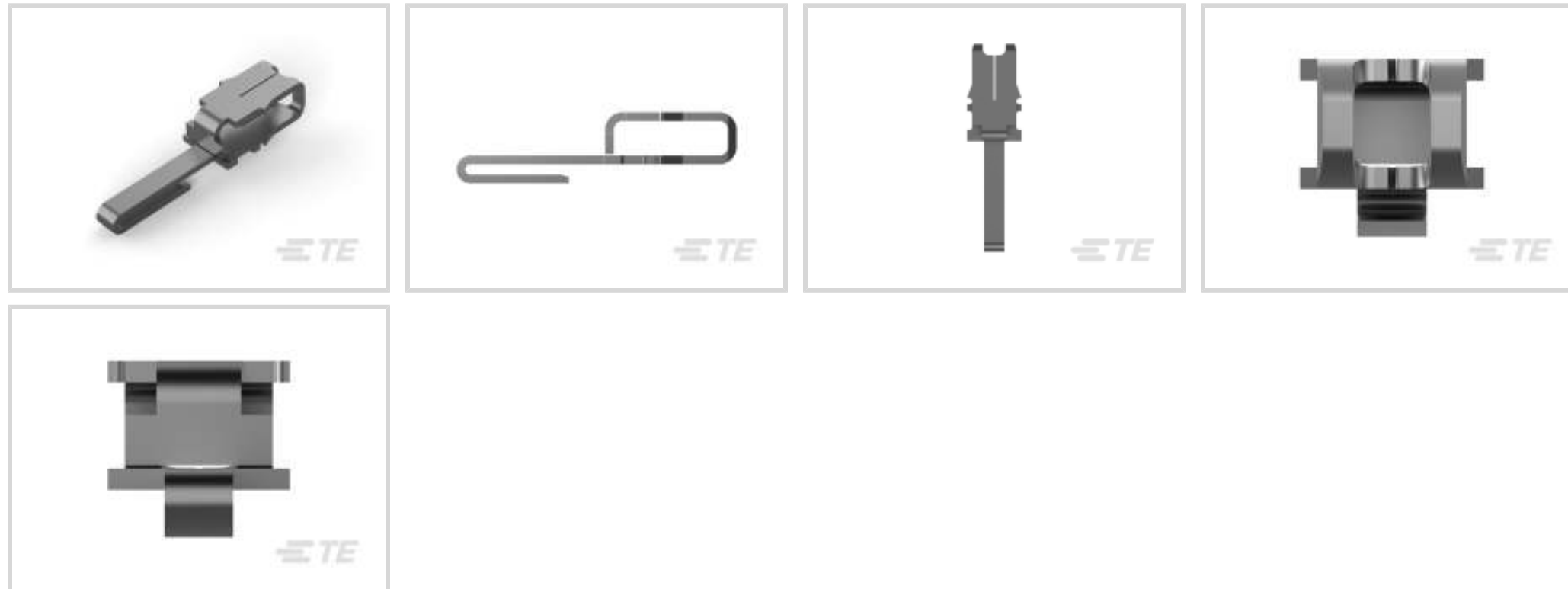

Magnet Wire Terminal Type: **RAST 5D**

Aluminum Wire Size: **.08 – .16 mm**

Magnet Wire Size: **.27 – .4 mm**

Features

Product Type Features

Compatible With Discrete Wire Type	Magnet Wire, Solid
------------------------------------	--------------------

Contact Features

Magnet Wire Terminal Type	RAST 5D
---------------------------	---------

Terminal Plating Material	Tin
---------------------------	-----

Terminal Orientation	Straight
----------------------	----------

Termination Features

Termination Method to Wire & Cable	Insulation Displacement (IDC)
------------------------------------	-------------------------------

Dimensions

Terminal Height	8.63 mm[.34 in]
-----------------	-----------------

Aluminum Wire Size	.08 – .16 mm
--------------------	--------------

Magnet Wire Size	.27 – .4 mm
------------------	-------------

Stock Thickness (Magnet Wire Side)	.32 mm[.013 in]
------------------------------------	-----------------

Product Length	16.2 mm[.637 in]
----------------	------------------

Usage Conditions

Insulation Option	Uninsulated
-------------------	-------------



Operation/Application

Compatible With Wire Base Material	Copper
------------------------------------	--------

Packaging Features

Packaging Method	Reel, Reel/Carton
------------------	-------------------

Product Compliance





[For compliance documentation, visit the product page on TE.com>](#)

EU RoHS Directive 2011/65/EU	Compliant
EU ELV Directive 2000/53/EC	Compliant
China RoHS 2 Directive MIIT Order No 32, 2016	No Restricted Materials Above Threshold
EU REACH Regulation (EC) No. 1907/2006	Current ECHA Candidate List: JUNE 2023 (235) Candidate List Declared Against: JAN 2023 (233) Does not contain REACH SVHC
Halogen Content	Low Halogen - Br, Cl, F, I < 900 ppm per homogenous material. Also BFR/CFR/PVC Free
Solder Process Capability	Not applicable for solder process capability

Product Compliance Disclaimer

This information is provided based on reasonable inquiry of our suppliers and represents our current actual knowledge based on the information they provided. This information is subject to change. The part numbers that TE has identified as EU RoHS compliant have a maximum concentration of 0.1% by weight in homogenous materials for lead, hexavalent chromium, mercury, PBB, PBDE, DBP, BBP, DEHP, DIBP, and 0.01% for cadmium, or qualify for an exemption to these limits as defined in the Annexes of Directive 2011/65/EU (RoHS2). Finished electrical and electronic equipment products will be CE marked as required by Directive 2011/65/EU. Components may not be CE marked. Additionally, the part numbers that TE has identified as EU ELV compliant have a maximum concentration of 0.1% by weight in homogenous materials for lead, hexavalent chromium, and mercury, and 0.01% for cadmium, or qualify for an exemption to these limits as defined in the Annexes of Directive 2000/53/EC (ELV). Regarding the REACH Regulation, the information TE provides on SVHC in articles for this part number is based on the latest European Chemicals Agency (ECHA) 'Guidance on requirements for substances in articles' posted at this URL: <https://echa.europa.eu/guidance-documents/guidance-on-reach>

Compatible Parts

 <p>TE Part # 1394430-3 MAG MATE CONT. 5D</p>	 <p>TE Part # 1394429-1 MAG MATE KONTAKT</p>	 <p>TE Part # 1394431-1 MAG MATE CONT. 5D</p>	 <p>TE Part # 1-1394430-1 MAG MATE KONTAKT</p>
--	--	--	---



Also in the Series | **MAG-MATE**

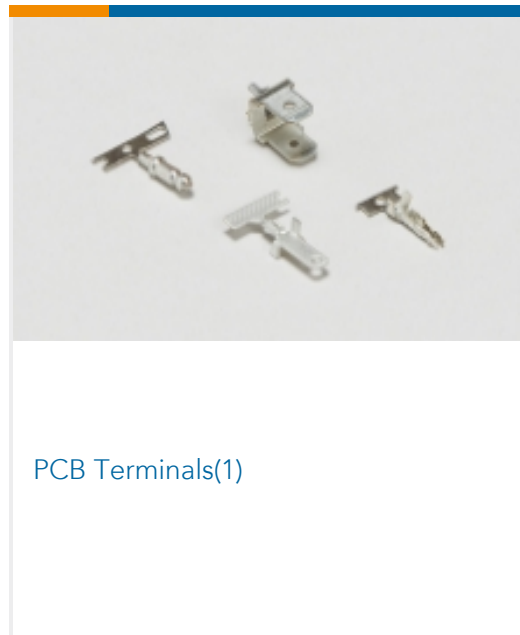
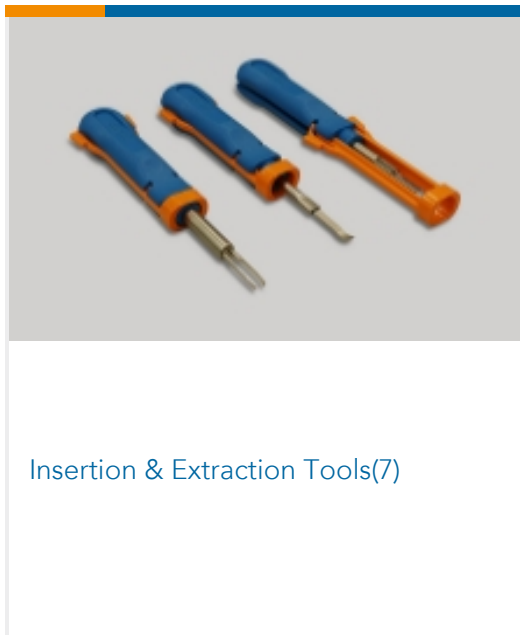

Customers Also Bought

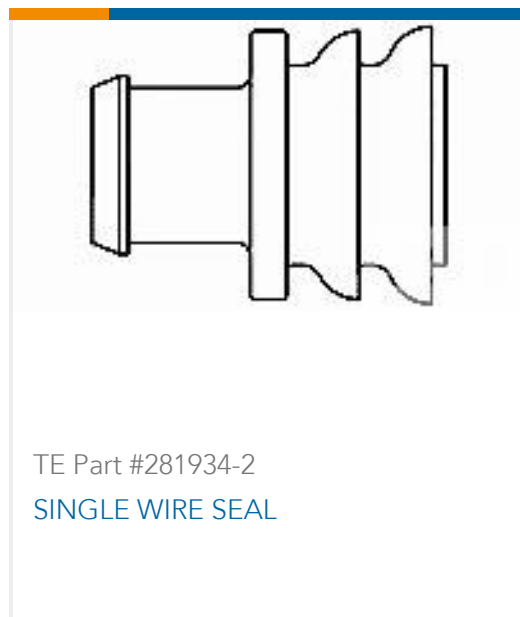

Documents

[Product Drawings](#)
MAG MATE KONTAKT

English

[CAD Files](#)

[3D PDF](#)

[3D](#)



Customer View Model

[ENG_CVM_CVM_1394430-1_A_c-1394430-1-a.2d_dxf.zip](#)

English

Customer View Model

[ENG_CVM_CVM_1394430-1_A_c-1394430-1-a.3d_igs.zip](#)

English

Customer View Model

[ENG_CVM_CVM_1394430-1_A_c-1394430-1-a.3d_stp.zip](#)

English

By downloading the CAD file I accept and agree to the [Terms and Conditions](#) of use.

Product Specifications

[Application Specification](#)

English

Product Environmental Compliance

[TE Material Declaration](#)

English

Instruction Sheets

[CONTACT CAVITY FOR RAST 5D](#)

English

[Instruction Sheet \(non U.S.\)](#)

English