

1379218-1 ✓ ACTIVE

MQS

TE Internal #: 1379218-1

Automotive Connector Caps & Covers, Cover, Black, PBT GF, -40 – 212 °F [-40 – 100 °C], MQS

[View on TE.com >](#)



Connectors > Automotive Connectors > Automotive Connector Accessories > Automotive Connector Caps & Covers



Protection & Strain Relief Accessory Type: **Cover**

Strain Relief: **Without**

Primary Product Color: **Black**

Primary Product Material: **PBT GF**

Operating Temperature (Max): **70 °C, 75 °C, 80 °C, 85 °C, 90 °C, 100 °C [158 °F, 167 °F, 176 °F, 185 °F, 194 °F, 212 °F]**

Features

Product Type Features

Protection & Strain Relief Accessory Type	Cover
---	-------

Body Features

Primary Product Color	Black
Primary Product Material	PBT GF

Mechanical Attachment

Strain Relief	Without
---------------	---------

Usage Conditions

Operating Temperature (Max)	70 °C, 75 °C, 80 °C, 85 °C, 90 °C, 100 °C [158 °F][167 °F][176 °F][185 °F][194 °F][212 °F]
Operating Temperature Range	-40 – 100 °C[-40 – 212 °F]

Packaging Features

Packaging Quantity	5000
Packaging Method	Box

Other



Serviceable	No
-------------	----

Product Compliance

[For compliance documentation, visit the product page on TE.com>](#)

EU RoHS Directive 2011/65/EU	Compliant
EU ELV Directive 2000/53/EC	Compliant
China RoHS 2 Directive MIIT Order No 32, 2016	No Restricted Materials Above Threshold
EU REACH Regulation (EC) No. 1907/2006	Current ECHA Candidate List: JUNE 2023 (235) Candidate List Declared Against: JAN 2023 (233) Does not contain REACH SVHC
Halogen Content	Low Halogen - Br, Cl, F, I < 900 ppm per homogenous material. Also BFR/CFR/PVC Free
Solder Process Capability	Not applicable for solder process capability

Product Compliance Disclaimer

This information is provided based on reasonable inquiry of our suppliers and represents our current actual knowledge based on the information they provided. This information is subject to change. The part numbers that TE has identified as EU RoHS compliant have a maximum concentration of 0.1% by weight in homogenous materials for lead, hexavalent chromium, mercury, PBB, PBDE, DBP, BBP, DEHP, DIBP, and 0.01% for cadmium, or qualify for an exemption to these limits as defined in the Annexes of Directive 2011/65/EU (RoHS2). Finished electrical and electronic equipment products will be CE marked as required by Directive 2011/65/EU. Components may not be CE marked. Additionally, the part numbers that TE has identified as EU ELV compliant have a maximum concentration of 0.1% by weight in homogenous materials for lead, hexavalent chromium, and mercury, and 0.01% for cadmium, or qualify for an exemption to these limits as defined in the Annexes of Directive 2000/53/EC (ELV). Regarding the REACH Regulation, the information TE provides on SVHC in articles for this part number is based on the latest European Chemicals Agency (ECHA) 'Guidance on requirements for substances in articles' posted at this URL: <https://echa.europa.eu/guidance-documents/guidance-on-reach>

Compatible Parts



Also in the Series | **MQS**



Automotive Connector Caps & Covers (138)



Automotive Connector EMC Shielding (3)

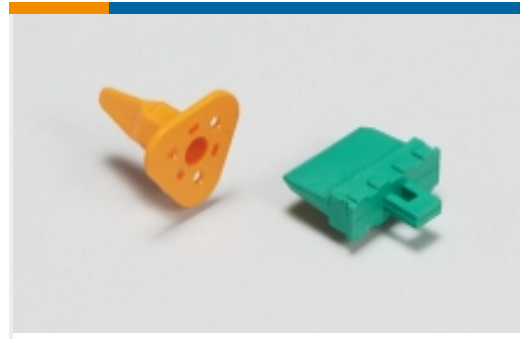

Automotive Connector Locks & Position Assurance(30)



Automotive Housings(506)



Automotive Terminals(104)



Connector Seals & Cavity Plugs(27)



Insertion & Extraction Tools(42)



Other Automotive Connector Accessories(14)

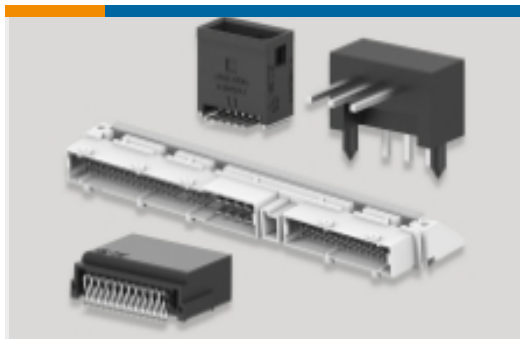

PCB Headers & Receptacles(214)

Customers Also Bought



TE Part #770586-1
22P MINI UMNL PLUG HSG

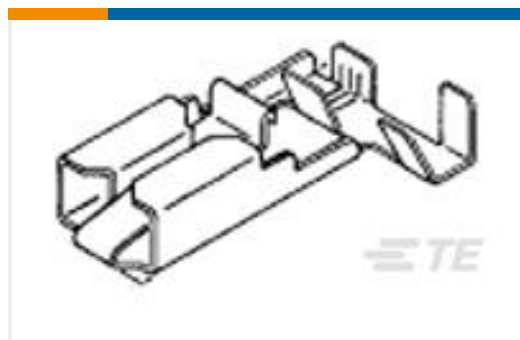

TE Part #926790-6
PL 250 REC TERMINAL-FLAG 17-13 TPBR



TE Part #2209477-1
MQS, CONNECTOR HOUSING

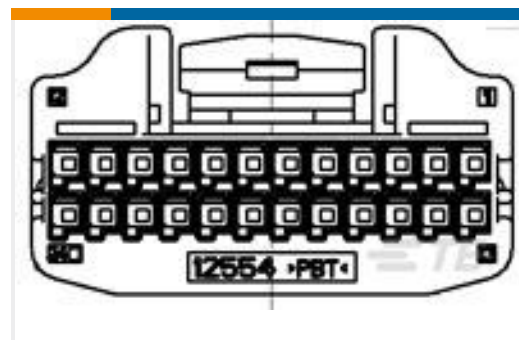

TE Part #1717115-1
0.64 III 28POS PLUG ASSY

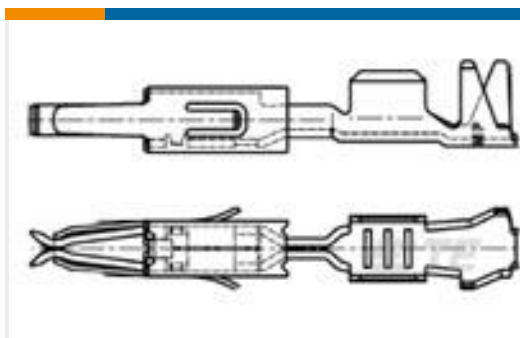

TE Part #964263-3
MT2 A REC 1.6 Contact SRC Au



TE Part #1924968-8
CONTACT, MALE 0.64, 0.35SQMM



TE Part #1241390-1
AMP MCP 2.8K, CONTACT

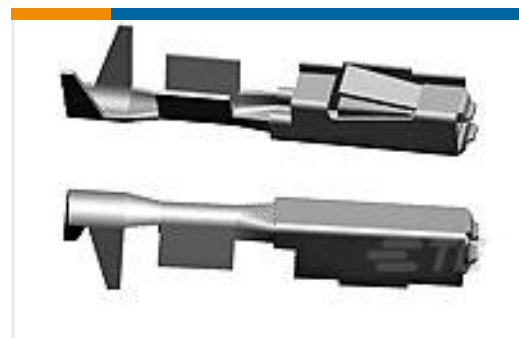

TE Part #968075-2
MPQ2,8 Sn rec LL unseal. >1-2,5

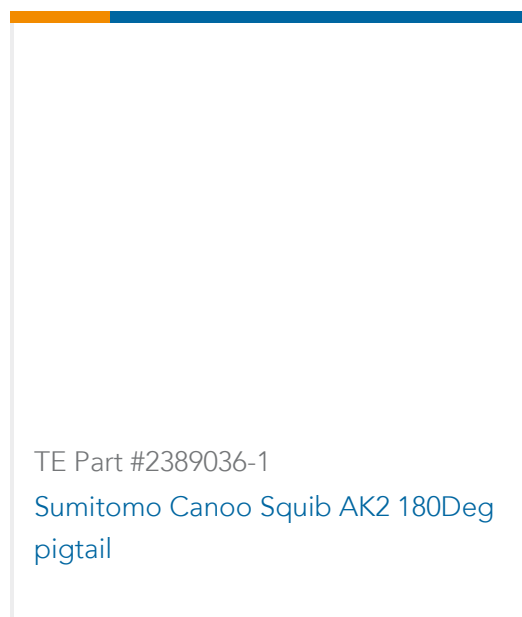

Documents

Product Drawings

[COVER FOR 5W MPQ+MQS HSG](#)

English

CAD Files

Customer View Model

[ENG_CVM_CVM_1379218-1_O.2d_dxf.zip](#)

English

[3D PDF](#)

3D

Customer View Model

[ENG_CVM_CVM_1379218-1_O.3d_igs.zip](#)

English

Customer View Model

[ENG_CVM_CVM_1379218-1_O.3d_stp.zip](#)

English

By downloading the CAD file I accept and agree to the [Terms and Conditions](#) of use.

Product Specifications

[2 WAY MPQ + 3 WAY MQS SOCKET HOUSING](#)

English

[Product Specification](#)

English