



DATA SHEET

BIPOLAR ANALOG INTEGRATED CIRCUITS μ PC2757TB, μ PC2758TB

SILICON MMIC 1st FREQUENCY DOWN-CONVERTER FOR CELLULAR/CORDLESS TELEPHONE

DESCRIPTION

The μ PC2757TB and μ PC2758TB are silicon monolithic integrated circuit designed as 1st frequency down-converter for cellular/cordless telephone receiver stage. The ICs consist of mixer and local amplifier. The μ PC2757TB features low current consumption and the μ PC2758TB features improved intermodulation. From these two version, you can chose either IC corresponding to your system design. These TB suffix ICs which are smaller package than conventional T suffix ICs contribute to reduce your system size.

The μ PC2757TB and μ PC2758TB are manufactured using Renesas 20 GHz fr NESATTMIII silicon bipolar process. This process uses silicon nitride passivation film and gold electrodes. These materials can protect chip surface from external pollution and prevent corrosion/migration. Thus, this IC has excellent performance, uniformity and reliability.

FEATURES

- Wideband operation : $f_{RFin} = 0.1$ to 2.0 GHz, $f_{FOut} = 20$ to 300 MHz
- High-density surface mounting : 6-pin super minimold package
- Low current consumption : $I_{CC} = 5.6$ mA TYP. @ μ PC2757TB
 $I_{CC} = 11$ mA TYP. @ μ PC2758TB
- Supply voltage : $V_{CC} = 2.7$ to 3.3 V
- Minimized carrier leakage : Due to double balanced mixer
- Equable output impedance : Single-end push-pull IF amplifier
- Built-in power save function

APPLICATIONS

- Cellular/cordless telephone up to 2.0 GHz MAX. (example: GSM, PDC800M, PDC1.5G and so on): μ PC2758TB
- Cellular/cordless telephone up to 2.0 GHz MAX. (example: CT1, CT2 and so on): μ PC2757TB

ORDERING INFORMATION

Part Number	Package	Markings	Supplying Form	Product Type
μ PC2757TB-E3	6-pin super minimold	C1X	Embossed tape 8 mm wide. Pin 1, 2, 3 face the tape perforation side. Qty 3kpcs/reel.	Low current consumption
μ PC2758TB-E3		C1Y		High OIP ₃

Remark To order evaluation samples, please contact your nearby sales office (Part number for sample order: μ PC2757TB-A, μ PC2758TB-A).

Caution Electro-static sensitive devices

CONTENTS

1. PIN CONNECTIONS.....	3
2. PRODUCT LINE-UP.....	3
3. INTERNAL BLOCK DIAGRAM.....	4
4. SYSTEM APPLICATION EXAMPLE.....	4
5. PIN EXPLANATION.....	5
6. ABSOLUTE MAXIMUM RATINGS.....	6
7. RECOMMENDED OPERATING RANGE.....	6
8. ELECTRICAL CHARACTERISTICS.....	6
9. STANDARD CHARACTERISTICS FOR REFERENCE.....	7
10. TEST CIRCUIT.....	8
11. ILLUSTRATION OF THE TEST CIRCUIT ASSEMBLED ON EVALUATION BOARD.....	8
12. TYPICAL CHARACTERISTICS.....	9
12.1 μ PC2757TB.....	9
12.2 μ PC2758TB.....	11
13. S-PARAMETERS.....	13
13.1 μ PC2757TB.....	13
13.2 μ PC2758TB.....	14
14. PACKAGE DIMENSIONS.....	15
15. NOTE ON CORRECT USE.....	16
16. RECOMMENDED SOLDERING CONDITIONS.....	16

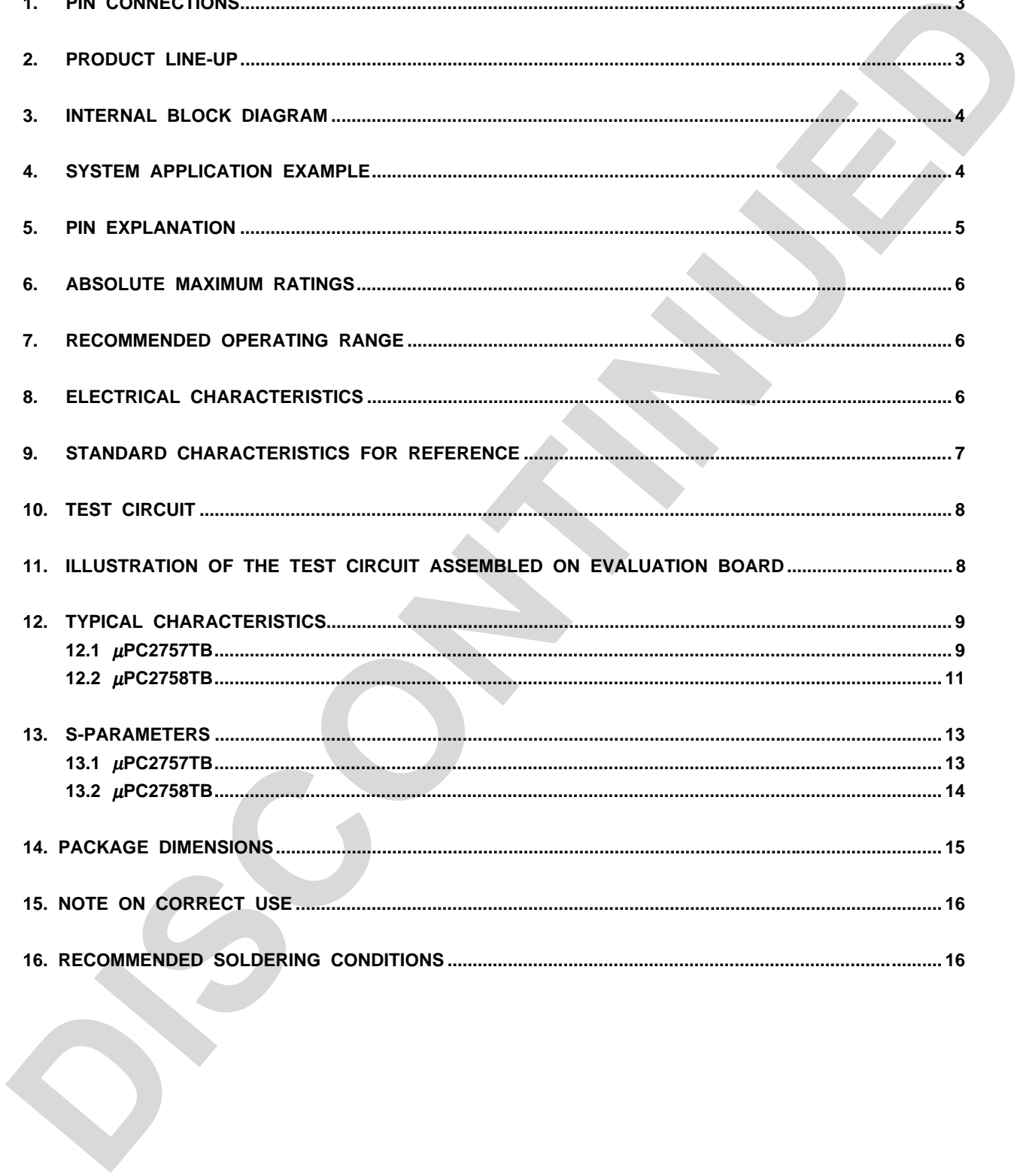

1. PIN CONNECTIONS

μ PC2757TB, μ PC2758TB in common

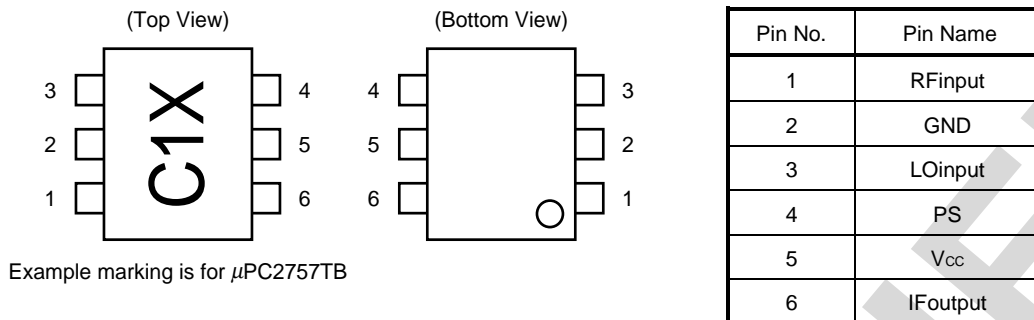

2. PRODUCT LINE-UP (T_A = +25°C, V_{CC} = V_{PS} = 3.0 V, Z_s = Z_L = 50 Ω)

Part No. / Items	No RF I _{cc} (mA)	900 MHz SSB · NF (dB)	1.5 GHz SSB · NF (dB)	1.9 GHz SSB · NF (dB)	900 MHz CG (dB)	1.5 GHz CG (dB)	1.9 GHz CG (dB)	900 MHz IIP ₃ (dBm)	1.5 GHz IIP ₃ (dBm)	1.9 GHz IIP ₃ (dBm)
μ PC2757T	5.6	10	10	13	15	15	13	-14	-14	-12
μ PC2757TB										
μ PC2758T	11	9	10	13	19	18	17	-13	-12	-11
μ PC2758TB										
μ PC8112T	8.5	9	11	11	15	13	13	-10	-9	-7
μ PC8112TB										

Part No. / Items	900 MHz P _{O(sat)} (dBm)	1.5 GHz P _{O(sat)} (dBm)	1.9 GHz P _{O(sat)} (dBm)	900 MHz RF _{Lo} (dB)	1.5 GHz RF _{Lo} (dB)	1.9 GHz RF _{Lo} (dB)	IF Output Configuration	Packages
μ PC2757T	-3	-	-8	-	-	-	Emitter follower	6-pin minimold
μ PC2757TB								6-pin super minimold
μ PC2758T	+1	-	-4	-	-	-		6-pin minimold
μ PC2758TB								6-pin super minimold
μ PC8112T	-2.5	-3	-3	-80	-57	-55	Open collector	6-pin minimold
μ PC8112TB								6-pin super minimold

Remark Typical performance. Please refer to ELECTRICAL CHARACTERISTICS in detail.

- Cautions**
- The μ PC2757 and μ PC2758's IIP₃ are calculated with Δ IM₃ = 3 which is the same IM₃ inclination as μ PC8112. On the other hand, OIP₃ of Standard characteristics in page 7 is cross point IP.
 - This document is to be specified for μ PC2757TB, μ PC2758TB. The other part number mentioned in this document should be referred to the data sheet of each part number.

3. INTERNAL BLOCK DIAGRAM (μ PC2757TB, μ PC2758TB in common)

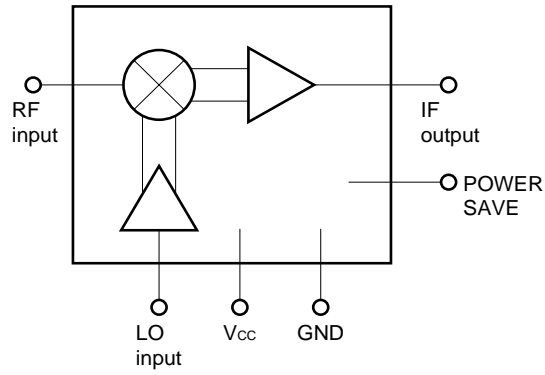

4. SYSTEM APPLICATION EXAMPLE

DIGITAL CELLULAR TELEPHONE

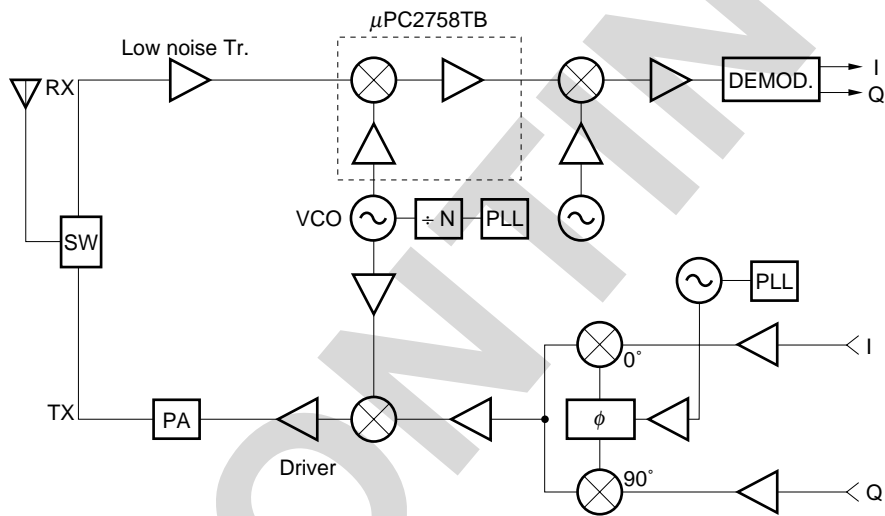

5. PIN EXPLANATION (Both μ PC2757TB, 2758TB)

Pin No.	Pin Name	Applied Voltage (V)	Pin Voltage (V) ^{Note}	Function and Application	Internal Equivalent Circuit								
1	RFinput	–	1.2	This pin is RF input for mixer designed as double balance type. This circuit contributes to suppress spurious signal with minimum LO and bias power consumption. Also this symmetrical circuit can keep specified performance insensitive to process-condition distribution.									
2	GND	GND	–	This pin is ground of IC. Must be connected to the system ground with minimum inductance. Ground pattern on the board should be formed as wide as possible. (Track length should be kept as short as possible.)	–								
3	LOinput	–	1.3	This pin is LO input for local buffer designed as differential amplifier. Recommendable input level is –15 to 0 dBm. Also this symmetrical circuit can keep specified performance insensitive to process-condition distribution.									
4	PS	Vcc or GND	–	This pin is for power-save function. This pin can control ON/OFF operation with bias as follows; <table border="1" style="margin: 10px auto;"> <thead> <tr> <th></th> <th>Bias: V</th> <th>Operation</th> </tr> </thead> <tbody> <tr> <td rowspan="2">V_{PS}</td> <td>≥ 2.5</td> <td>ON</td> </tr> <tr> <td>0 to 0.5</td> <td>OFF</td> </tr> </tbody> </table> Rise time/fall time using this pin are approximately 10 μ s.		Bias: V	Operation	V _{PS}	≥ 2.5	ON	0 to 0.5	OFF	
	Bias: V	Operation											
V _{PS}	≥ 2.5	ON											
	0 to 0.5	OFF											
5	Vcc	2.7 to 3.3	–	Supply voltage 3.0 \pm 0.3 V for operation. Must be connected bypass capacitor. (example: 1 000 pF) to minimize ground impedance.	–								
6	IFoutput	–	1.7	This pin is output from IF buffer amplifier designed as single-ended push-pull type. This pin is assigned for emitter follower output with low-impedance. In the case of connecting to high-impedance stage, please attach external matching circuit.									

Note Each pin voltage is measured at Vcc = 3.0 V

6. ABSOLUTE MAXIMUM RATINGS

Parameter	Symbol	Conditions	Ratings	Unit
Supply Voltage	V _{CC}	T _A = +25°C	5.5	V
★ Power Dissipation of Package Allowance	P _D	Mounted on 50 × 50 × 1.6 mm double sided copper clad epoxy glass board at T _A = +85°C	270	mW
Operating Ambient Temperature	T _A		-40 to +85	°C
Storage Temperature	T _{stg}		-55 to +150	°C
PS Pin Voltage	V _{PS}	T _A = +25°C	5.5	V

7. RECOMMENDED OPERATING RANGE

Parameter	Symbol	MIN.	TYP.	MAX.	Unit
Supply Voltage	V _{CC}	2.7	3.0	3.3	V
Operating Ambient Temperature	T _A	-40	+25	+85	°C
LO Input Power	P _{LOin}	-15	-10	0	dBm

8. ELECTRICAL CHARACTERISTICS (T_A = +25°C, V_{CC} = V_{PS} = 3.0 V, P_{LOin} = -10 dBm, Z_S = Z_L = 50 Ω)

Parameter	Symbol	Conditions	μ PC2757TB			μ PC2758TB			Unit
			MIN.	TYP.	MAX.	MIN.	TYP.	MAX.	
Circuit Current	I _{CC}	No input signal	3.7	5.6	7.7	6.6	11	14.8	mA
RF Input Frequency	f _{RFin}	CG ≥ (CG1 -3 dB) f _{IFout} = 130 MHz constant	0.1	-	2.0	0.1	-	2.0	GHz
IF Output Frequency	f _{IFout}	CG ≥ (CG1 -3 dB) f _{RFin} = 0.8 GHz constant	20	-	300	20	-	300	MHz
Conversion Gain 1	CG1	f _{RFin} = 0.8 GHz, f _{IFout} = 130 MHz P _{RFin} = -40 dBm, Upper local	12	15	18	16	19	22	dB
Conversion Gain 2	CG2	f _{RFin} = 2.0 GHz, f _{IFout} = 250 MHz P _{RFin} = -40 dBm, Lower local	10	13	16	14	17	20	dB
SSB Noise Figure 1	SSB • NF1	f _{RFin} = 0.8 GHz, f _{IFout} = 130 MHz, SSB mode, Upper local	-	10	13	-	9	12	dB
SSB Noise Figure 2	SSB • NF2	f _{RFin} = 2.0 GHz, f _{IFout} = 250 MHz, SSB mode, Lower local	-	13	16	-	13	15	dB
Saturated Output Power 1	P _{O(sat) 1}	f _{RFin} = 0.8 GHz, f _{IFout} = 130 MHz P _{RFin} = -10 dBm, Upper local	-11	-3	-	-7	+1	-	dBm
Saturated Output Power 2	P _{O(sat) 2}	f _{RFin} = 2.0 GHz, f _{IFout} = 250 MHz P _{RFin} = -10 dBm, Lower local	-11	-8	-	-7	-4	-	dBm

9. STANDARD CHARACTERISTICS FOR REFERENCE(Unless otherwise specified: $T_A = +25^\circ\text{C}$, $V_{CC} = V_{PS} = 3.0\text{ V}$, $P_{LOin} = -10\text{ dBm}$, $Z_S = Z_L = 50\ \Omega$)

Parameter	Symbol	Conditions	Reference Value		Unit
			μ PC2757TB	μ PC2758TB	
3rd Order Distortion Output Intercept Point	OIP ₃	$f_{RFin} = 0.8\text{ to }2.0\text{ GHz}$, $f_{Fout} = 0.1\text{ GHz}$, Cross point IP	+5	+11	dBm
LO Leakage at RF pin	LO _{rf}	$f_{LOin} = 0.8\text{ to }2.0\text{ GHz}$	-35	-30	dBm
LO Leakage at IF pin	LO _{if}	$f_{LOin} = 0.8\text{ to }2.0\text{ GHz}$	-23	-15	dBm
Circuit Current at Power Save Mode	I _{cc(PS)}	$V_{PS} = 0.5\text{ V}$	0.1	0.1	μA

10. TEST CIRCUIT

μ PC2757TB, μ PC2758TB

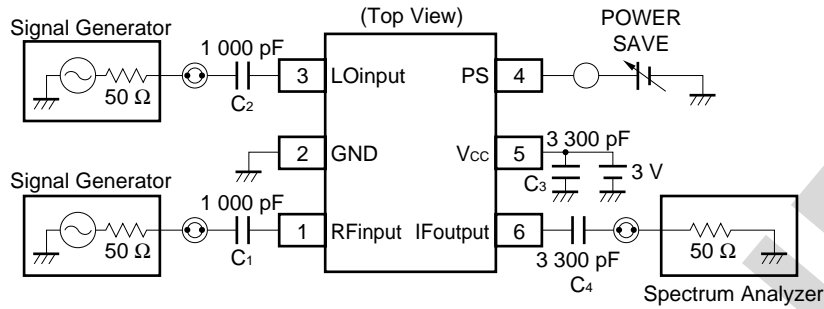

★ 11. ILLUSTRATION OF THE TEST CIRCUIT ASSEMBLED ON EVALUATION BOARD

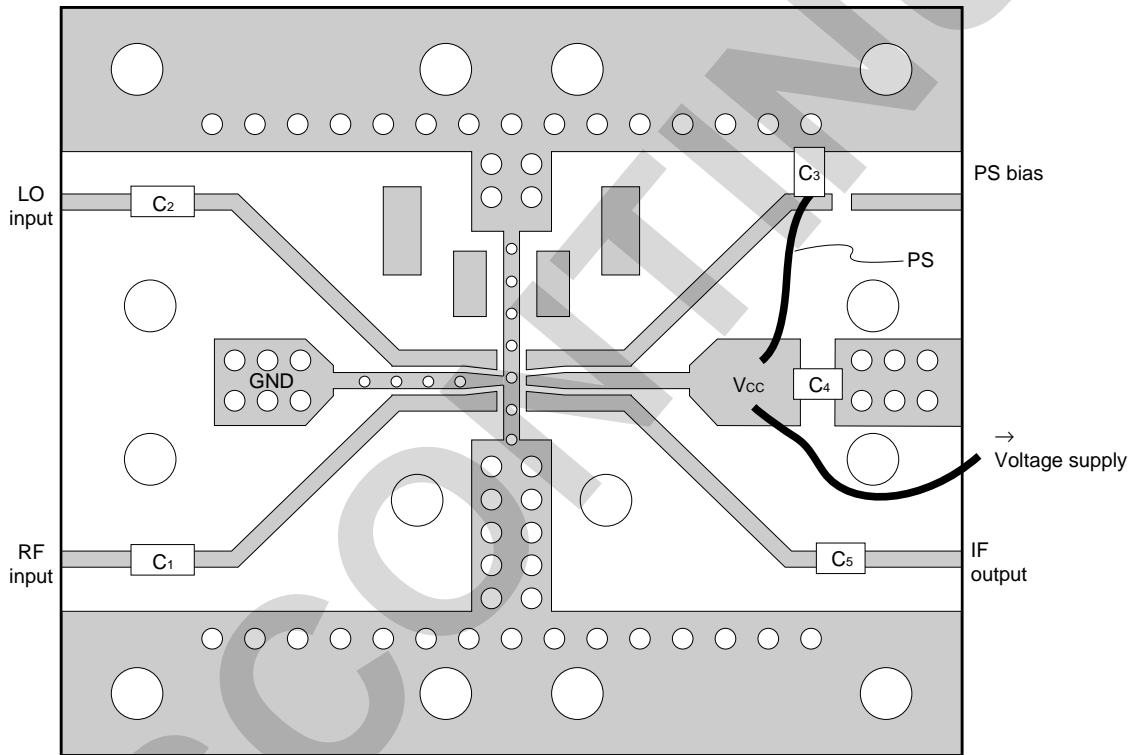

Component List

No.	Value
C1, C2	1 000 pF
C3 to C5	3 300 pF

Notes 1. 35 × 42 × 0.4 mm double sided copper clad polyimide board.

- 2. Back side: GND pattern
- 3. Solder plated on pattern
- 4. °O: Through holes

Application explanation

This IC is guaranteed on the test circuit constructed with 50 Ω equipment and transmission line.

This IC, however, does not have 50 Ω input/output impedance, but electrical characteristics such as conversion gain and intermodulation distortion are described herein on these conditions without impedance matching. So, you should understand that conversion gain and intermodulation distortion at input level will vary when you improve VS of RF input with external circuit (50 Ω termination or impedance matching.)

12. TYPICAL CHARACTERISTICS ($T_A = +25^\circ\text{C}$, on Measurement Circuit)

12.1 μ PC2757TB

CIRCUIT CURRENT vs. SUPPLY VOLTAGE

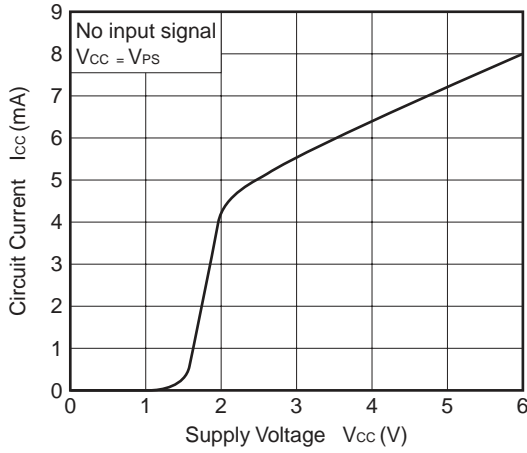

CONVERSION GAIN vs. RF INPUT FREQUENCY

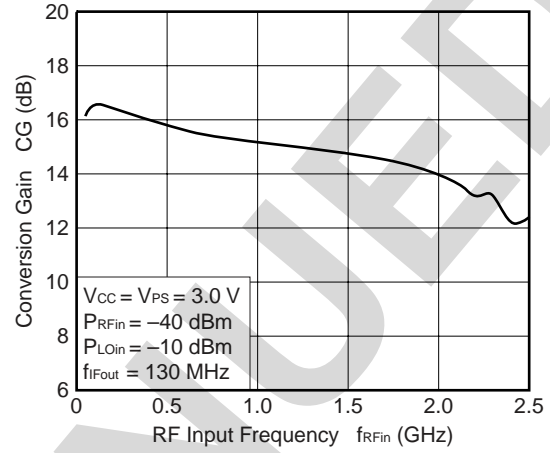

SSB NOISE FIGURE vs. RF INPUT FREQUENCY

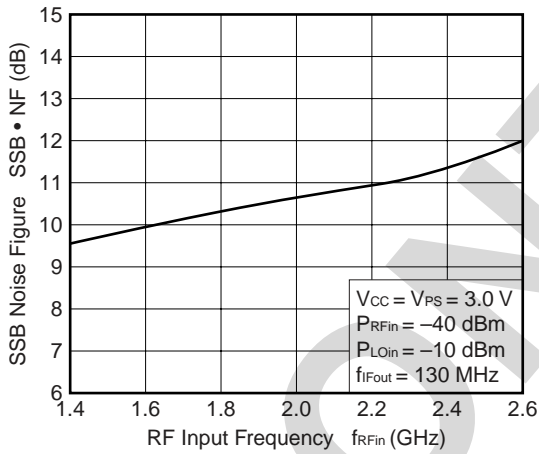

CONVERSION GAIN vs. IF OUTPUT FREQUENCY

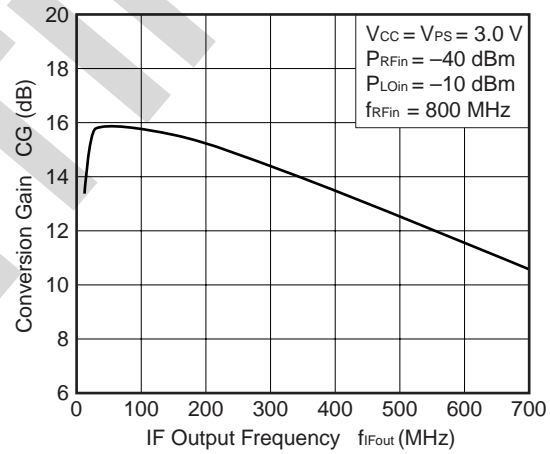

CONVERSION GAIN vs. LO INPUT POWER

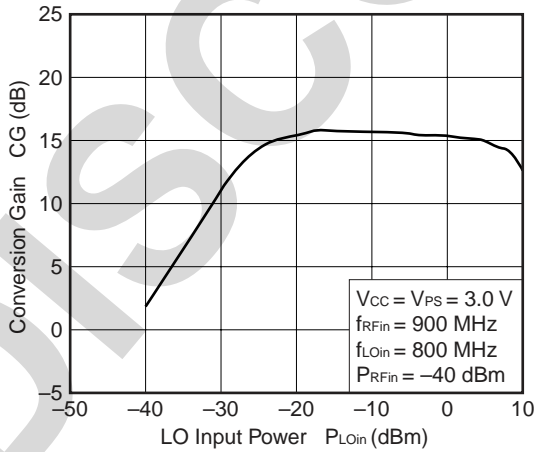

CONVERSION GAIN vs. LO INPUT POWER

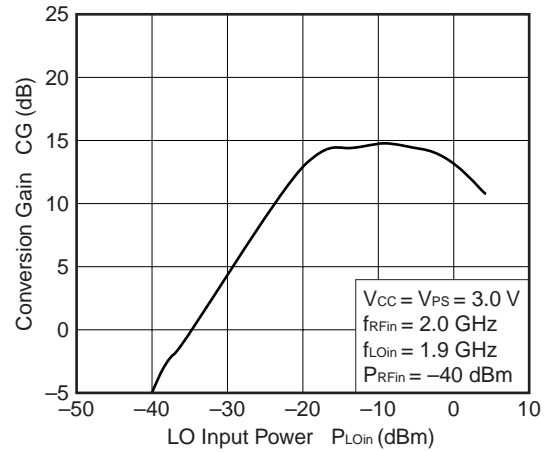

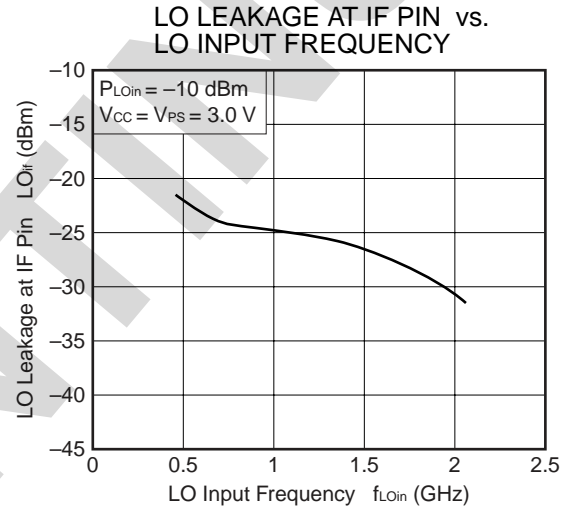
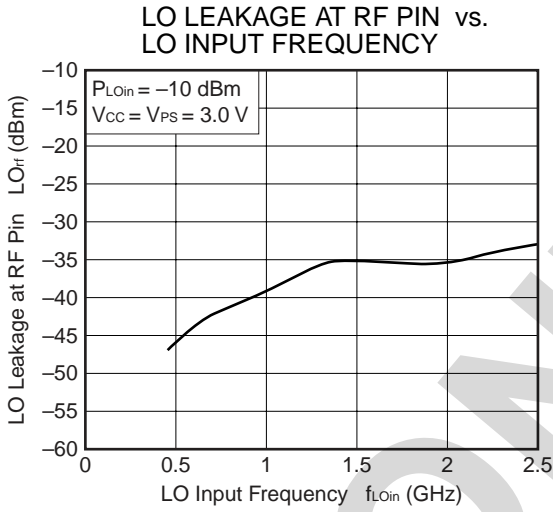
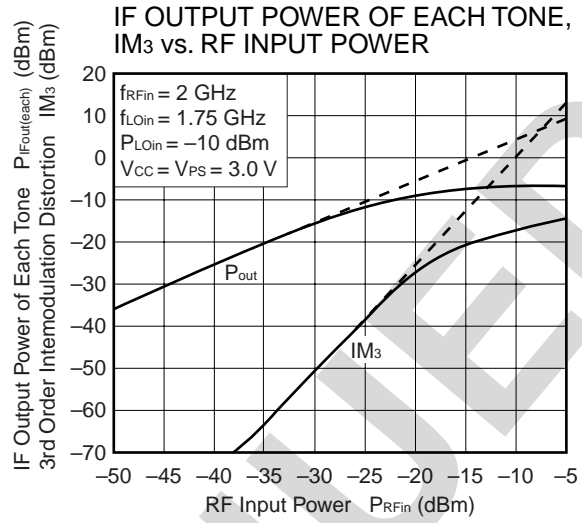
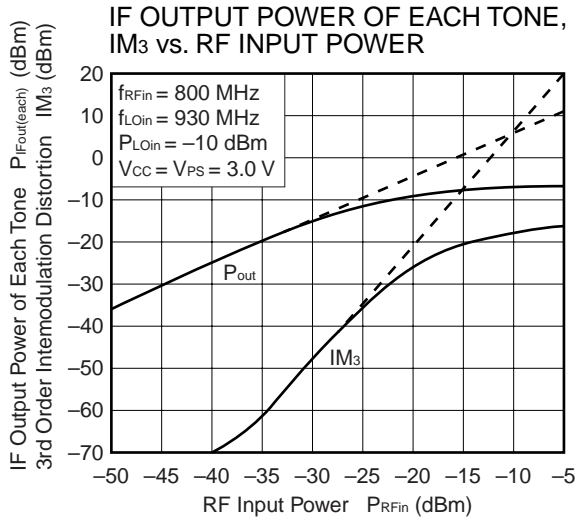

Remark The graphs indicate nominal characteristics.

12.2 μ PC2758TB

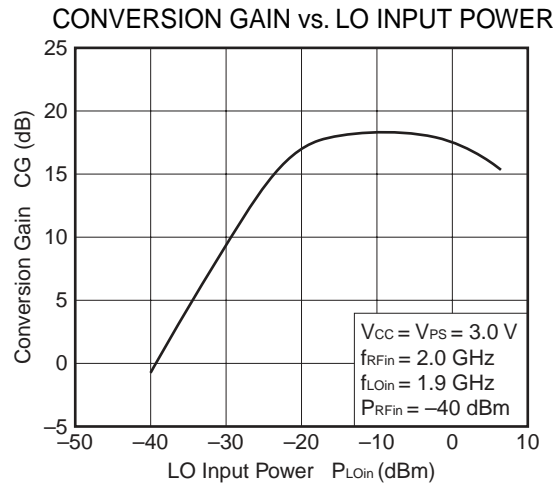
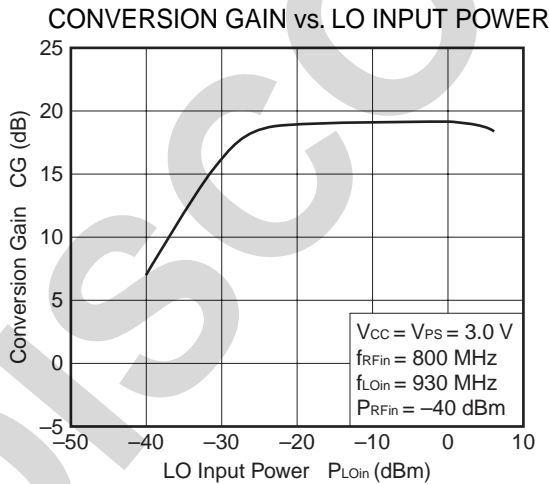
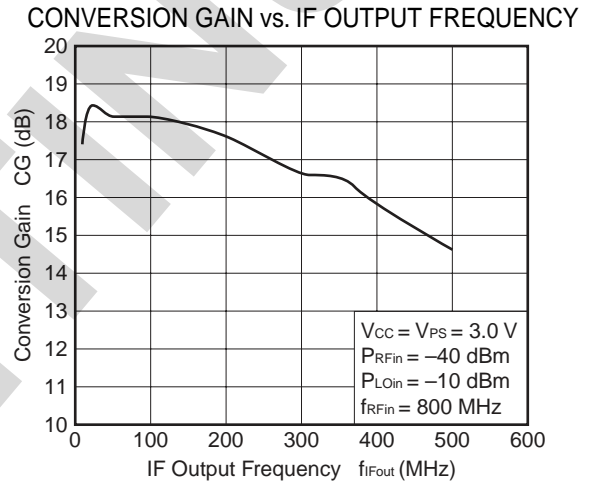
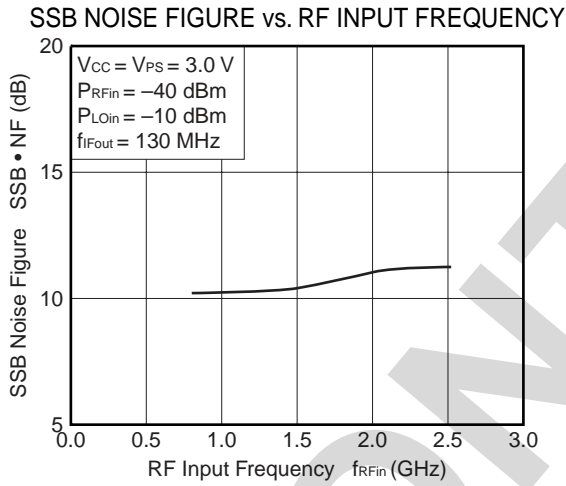
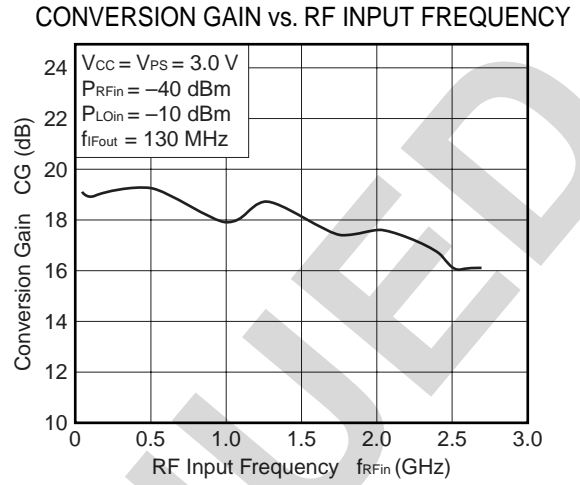
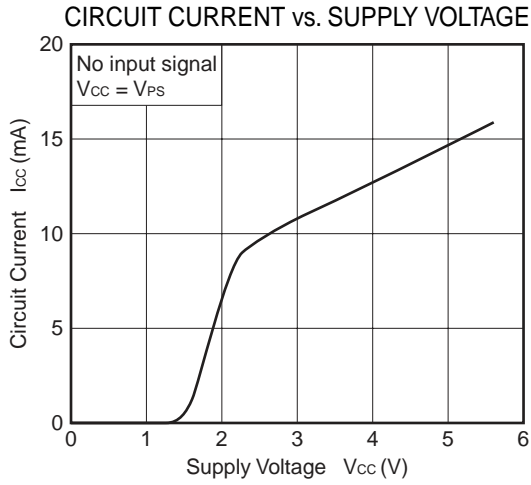

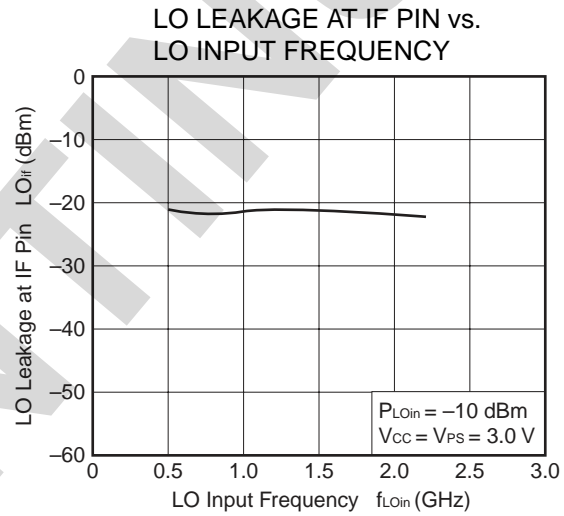
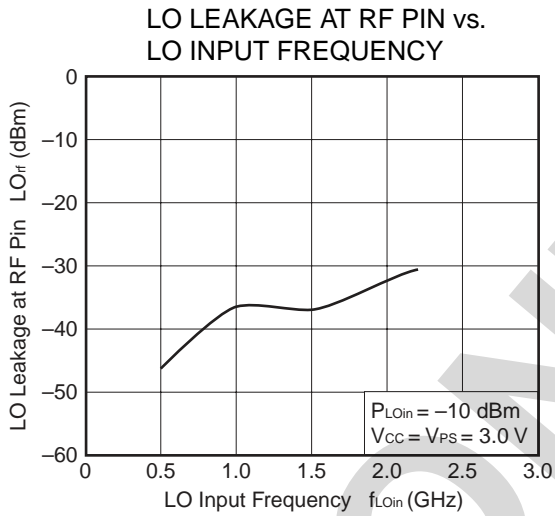
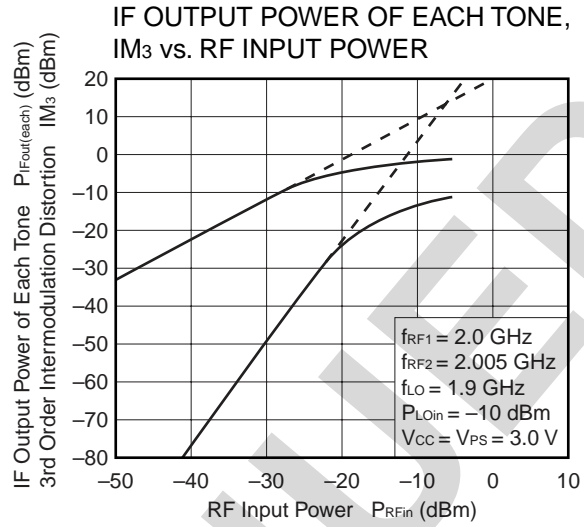
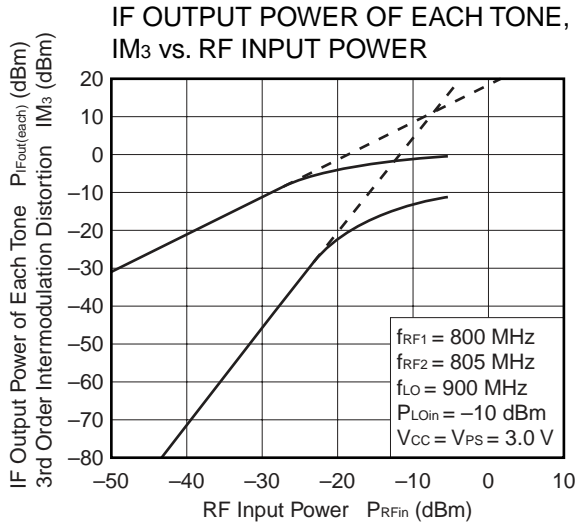

Remark The graphs indicate nominal characteristics.

13. S-PARAMETERS

13.1 μ PC2757TB

Calibrated on pin of DUT

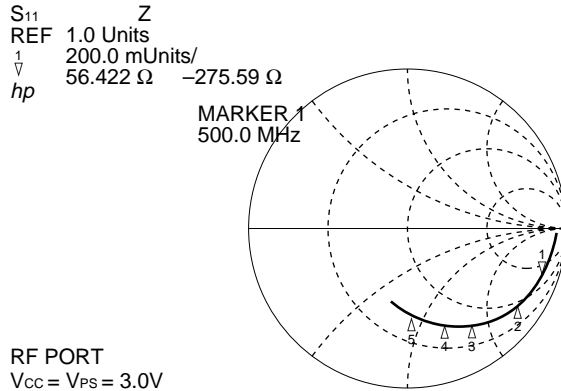

RF PORT
 V_{CC} = V_{PS} = 3.0V
 1:500 MHz 56.422 Ω -j275.59 Ω START 0.050000000 GHz
 2:900 MHz 38.68 Ω -j152.71 Ω STOP 3.000000000 GHz
 3:1 500 MHz 31.699 Ω -j88.102 Ω
 4:1 900 MHz 29.209 Ω -j65.926 Ω
 5:2 500 MHz 29.209 Ω -j44.758 Ω

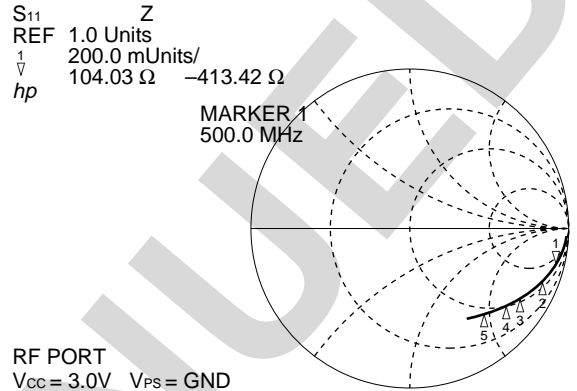

RF PORT
 V_{CC} = 3.0V V_{PS} = GND
 1:500 MHz 104.03 Ω -j413.42 Ω START 0.050000000 GHz
 2:900 MHz 74.82 Ω -j243.06 Ω STOP 3.000000000 GHz
 3:1 500 MHz 59.266 Ω -j154.98 Ω
 4:1 900 MHz 51.227 Ω -j124.55 Ω
 5:2 500 MHz 43.996 Ω -j95.117 Ω

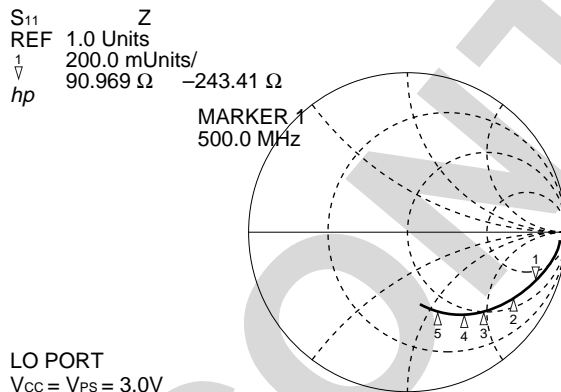

LO PORT
 V_{CC} = V_{PS} = 3.0V
 1:500 MHz 90.969 Ω -j243.41 Ω START 0.050000000 GHz
 2:900 MHz 67.828 Ω -j150.32 Ω STOP 3.000000000 GHz
 3:1 500 MHz 51.488 Ω -j97.273 Ω
 4:1 900 MHz 44.621 Ω -j77.352 Ω
 5:2 500 MHz 39.627 Ω -j56.738 Ω

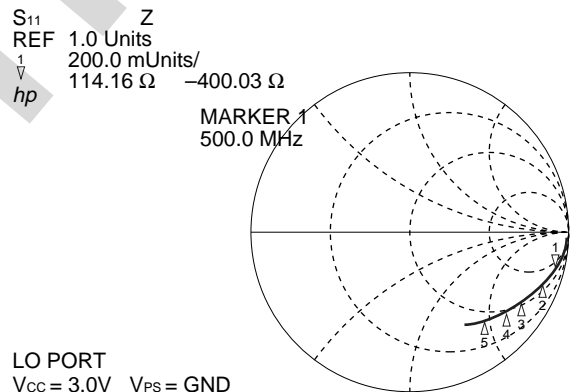

LO PORT
 V_{CC} = 3.0V V_{PS} = GND
 1:500 MHz 114.16 Ω -j400.03 Ω START 0.050000000 GHz
 2:900 MHz 75.133 Ω -j242.73 Ω STOP 3.000000000 GHz
 3:1 500 MHz 53.516 Ω -j154.21 Ω
 4:1 900 MHz 44.789 Ω -j124.74 Ω
 5:2 500 MHz 37.004 Ω -j93.828 Ω

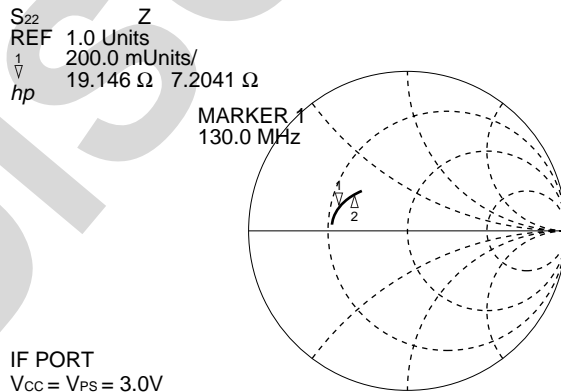

IF PORT
 V_{CC} = V_{PS} = 3.0V
 1:130 MHz 19.146 Ω -j7.2041 Ω START 0.050000000 GHz
 2:250 MHz 22.73 Ω -j12.909 Ω STOP 3.000000000 GHz

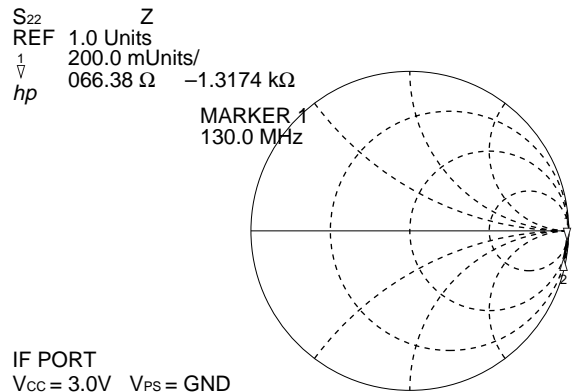

IF PORT
 V_{CC} = 3.0V V_{PS} = GND
 1:130 MHz 66.38 Ω -j1.3174 k Ω START 0.050000000 GHz
 2:250 MHz 88.281 Ω -j725.41 Ω STOP 3.000000000 GHz

13.2 μ PC2758TB

Calibrated on pin of DUT

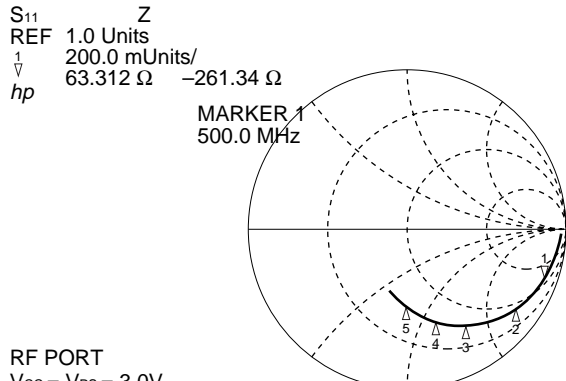

RF PORT
V_{CC} = V_{PS} = 3.0V

1:500 MHz	63.312 Ω -j261.34 Ω
2:900 MHz	40.227 Ω -j142.36 Ω
3:1 500 MHz	32.441 Ω -j79.68 Ω
4:1 900 MHz	31.107 Ω -j58.273 Ω
5:2 500 MHz	30.871 Ω -j39.08 Ω

START 0.050000000 GHz
STOP 3.000000000 GHz

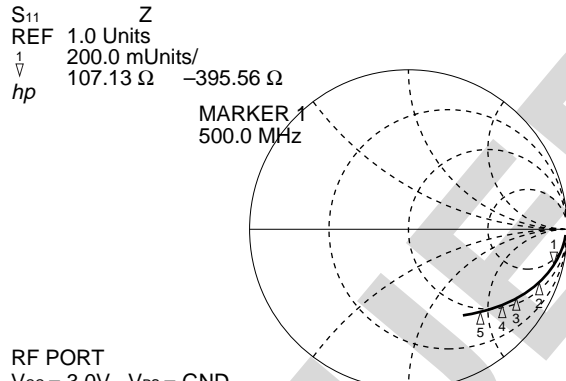

RF PORT
V_{CC} = 3.0V V_{PS} = GND

1:500 MHz	107.13 Ω -j395.56 Ω
2:900 MHz	78.711 Ω -j234.41 Ω
3:1 500 MHz	61.922 Ω -j148.82 Ω
4:1 900 MHz	52.629 Ω -j119.55 Ω
5:2 500 MHz	44.766 Ω -j90.578 Ω

START 0.050000000 GHz
STOP 3.000000000 GHz

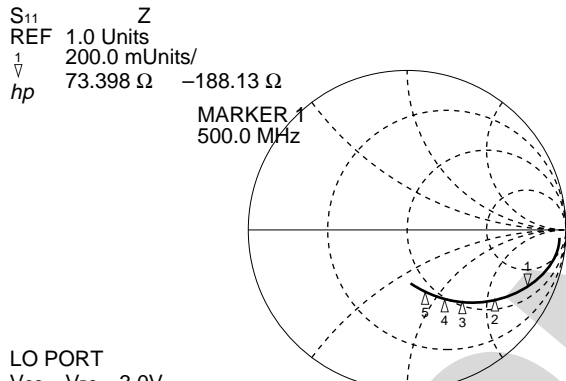

LO PORT
V_{CC} = V_{PS} = 3.0V

1:500 MHz	73.398 Ω -j188.13 Ω
2:900 MHz	64.551 Ω -j112.66 Ω
3:1 500 MHz	53.133 Ω -j72.941 Ω
4:1 900 MHz	48.111 Ω -j57.307 Ω
5:2 500 MHz	44.541 Ω -j41.564 Ω

START 0.050000000 GHz
STOP 3.000000000 GHz

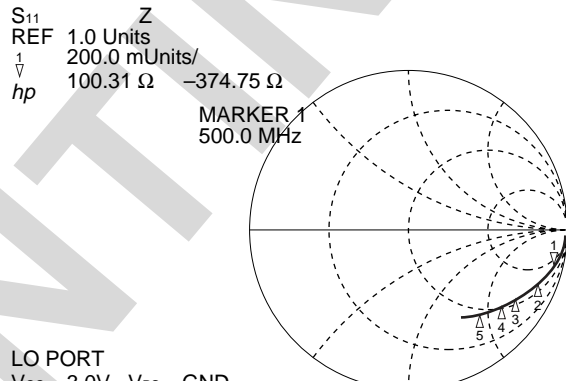

LO PORT
V_{CC} = 3.0V V_{PS} = GND

1:500 MHz	100.31 Ω -j374.75 Ω
2:900 MHz	73.148 Ω -j223.07 Ω
3:1 500 MHz	57.719 Ω -j144.02 Ω
4:1 900 MHz	50.738 Ω -j119.52 Ω
5:2 500 MHz	41.836 Ω -j90.25 Ω

START 0.050000000 GHz
STOP 3.000000000 GHz

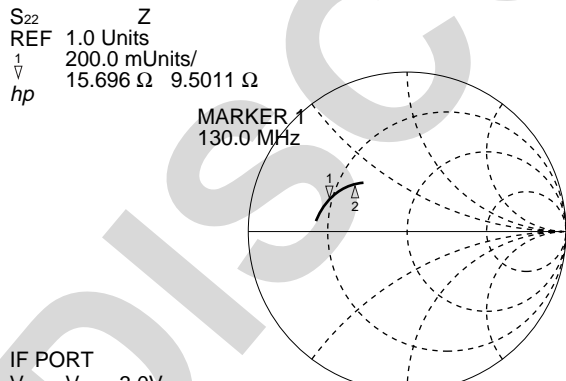

IF PORT
V_{CC} = V_{PS} = 3.0V

1:130 MHz	15.696 Ω -j9.5811 Ω
2:250 MHz	21.4 Ω -j16.331 Ω

START 0.050000000 GHz
STOP 3.000000000 GHz

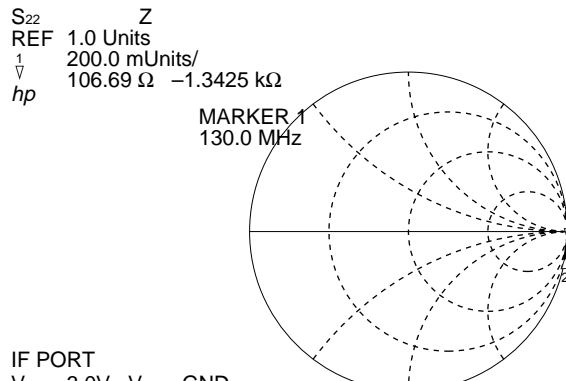

IF PORT
V_{CC} = 3.0V V_{PS} = GND

1:130 MHz	106.69 Ω -j1.3425 k Ω
2:250 MHz	83.75 Ω -j711.47 Ω

START 0.050000000 GHz
STOP 3.000000000 GHz

★ 14. PACKAGE DIMENSIONS

6-PIN SUPER MINIMOLD (UNIT: mm)

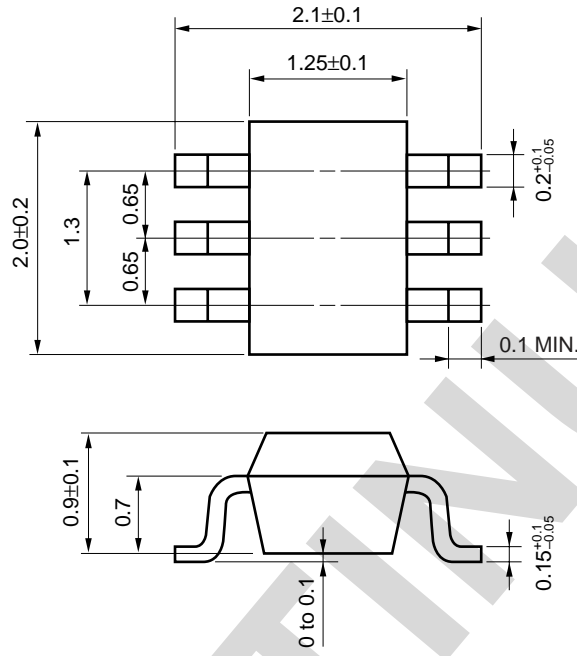

DISCONTINUED

15. NOTE ON CORRECT USE

- (1) Observe precautions for handling because of electrostatic sensitive devices.
- (2) Form a ground pattern as widely as possible to minimize ground impedance (to prevent undesired oscillation).
Keep the track length of the ground pins as short as possible.
- (3) Connect a bypass capacitor (example: 1 000 pF) to the Vcc pin.
- (4) The DC cut capacitor must be attached to input pin.

16. RECOMMENDED SOLDERING CONDITIONS

This product should be soldered under the following recommended conditions.

Soldering Method	Soldering Condition	Recommended Condition Symbol
Infrared Reflow	Package peak temperature: 235°C or below Time: 30 seconds or less (at 210°C) Count: 3, Exposure limit: None ^{Note}	IR35-00-3
VPS	Package peak temperature: 215°C or below Time: 40 seconds or less (at 200°C) Count: 3, Exposure limit: None ^{Note}	VP15-00-3
Wave Soldering	Soldering bath temperature: 260°C or below Time: 10 seconds or less Count: 1, Exposure limit: None ^{Note}	WS60-00-1
Partial Heating	Pin temperature: 300°C Time: 3 seconds or less (per side of device) Exposure limit: None ^{Note}	–

Note After opening the dry pack, keep it in a place below 25°C and 65% RH for the allowable storage period.

Caution Do not use different soldering methods together (except for partial heating).

For details of recommended soldering conditions for surface mounting, refer to information document SEMICONDUCTOR DEVICE MOUNTING TECHNOLOGY MANUAL (C10535E).

NOTICE

1. Descriptions of circuits, software and other related information in this document are provided only to illustrate the operation of semiconductor products and application examples. You are fully responsible for the incorporation of these circuits, software, and information in the design of your equipment. California Eastern Laboratories and Renesas Electronics assumes no responsibility for any losses incurred by you or third parties arising from the use of these circuits, software, or information.
2. California Eastern Laboratories has used reasonable care in preparing the information included in this document, but California Eastern Laboratories does not warrant that such information is error free. California Eastern Laboratories and Renesas Electronics assumes no liability whatsoever for any damages incurred by you resulting from errors in or omissions from the information included herein.
3. California Eastern Laboratories and Renesas Electronics do not assume any liability for infringement of patents, copyrights, or other intellectual property rights of third parties by or arising from the use of Renesas Electronics products or technical information described in this document. No license, express, implied or otherwise, is granted hereby under any patents, copyrights or other intellectual property rights of California Eastern Laboratories or Renesas Electronics or others.
4. You should not alter, modify, copy, or otherwise misappropriate any Renesas Electronics product, whether in whole or in part. California Eastern Laboratories and Renesas Electronics assume no responsibility for any losses incurred by you or third parties arising from such alteration, modification, copy or otherwise misappropriation of Renesas Electronics product.
5. Renesas Electronics products are classified according to the following two quality grades: "Standard" and "High Quality". The recommended applications for each Renesas Electronics product depends on the product's quality grade, as indicated below. "Standard": Computers; office equipment; communications equipment; test and measurement equipment; audio and visual equipment; home electronic appliances; machine tools; personal electronic equipment; and industrial robots etc. "High Quality": Transportation equipment (automobiles, trains, ships, etc.); traffic control systems; anti-disaster systems; anti-crime systems; and safety equipment etc. Renesas Electronics products are neither intended nor authorized for use in products or systems that may pose a direct threat to human life or bodily injury (artificial life support devices or systems, surgical implantations etc.), or may cause serious property damages (nuclear reactor control systems, military equipment etc.). You must check the quality grade of each Renesas Electronics product before using it in a particular application. You may not use any Renesas Electronics product for any application for which it is not intended. California Eastern Laboratories and Renesas Electronics shall not be in any way liable for any damages or losses incurred by you or third parties arising from the use of any Renesas Electronics product for which the product is not intended by California Eastern Laboratories or Renesas Electronics.
6. You should use the Renesas Electronics products described in this document within the range specified by California Eastern Laboratories, especially with respect to the maximum rating, operating supply voltage range, movement power voltage range, heat radiation characteristics, installation and other product characteristics. California Eastern Laboratories shall have no liability for malfunctions or damages arising out of the use of Renesas Electronics products beyond such specified ranges.
7. Although Renesas Electronics endeavors to improve the quality and reliability of its products, semiconductor products have specific characteristics such as the occurrence of failure at a certain rate and malfunctions under certain use conditions. Further, Renesas Electronics products are not subject to radiation resistance design. Please be sure to implement safety measures to guard them against the possibility of physical injury, and injury or damage caused by fire in the event of the failure of a Renesas Electronics product, such as safety design for hardware and software including but not limited to redundancy, fire control and malfunction prevention, appropriate treatment for aging degradation or any other appropriate measures. Because the evaluation of microcomputer software alone is very difficult, please evaluate the safety of the final products or systems manufactured by you.
8. Please contact a California Eastern Laboratories sales office for details as to environmental matters such as the environmental compatibility of each Renesas Electronics product. Please use Renesas Electronics products in compliance with all applicable laws and regulations that regulate the inclusion or use of controlled substances, including without limitation, the EU RoHS Directive. California Eastern Laboratories and Renesas Electronics assume no liability for damages or losses occurring as a result of your noncompliance with applicable laws and regulations.
9. Renesas Electronics products and technology may not be used for or incorporated into any products or systems whose manufacture, use, or sale is prohibited under any applicable domestic or foreign laws or regulations. You should not use Renesas Electronics products or technology described in this document for any purpose relating to military applications or use by the military, including but not limited to the development of weapons of mass destruction. When exporting the Renesas Electronics products or technology described in this document, you should comply with the applicable export control laws and regulations and follow the procedures required by such laws and regulations.
10. It is the responsibility of the buyer or distributor of California Eastern Laboratories, who distributes, disposes of, or otherwise places the Renesas Electronics product with a third party, to notify such third party in advance of the contents and conditions set forth in this document, California Eastern Laboratories and Renesas Electronics assume no responsibility for any losses incurred by you or third parties as a result of unauthorized use of Renesas Electronics products.
11. This document may not be reproduced or duplicated in any form, in whole or in part, without prior written consent of California Eastern Laboratories.
12. Please contact a California Eastern Laboratories sales office if you have any questions regarding the information contained in this document or Renesas Electronics products, or if you have any other inquiries.

NOTE 1: "Renesas Electronics" as used in this document means Renesas Electronics Corporation and also includes its majority-owned subsidiaries.

NOTE 2: "Renesas Electronics product(s)" means any product developed or manufactured by or for Renesas Electronics.

NOTE 3: Products and product information are subject to change without notice.

CEL Headquarters • 4590 Patrick Henry Drive, Santa Clara, CA 95054 • Phone (408) 919-2500 • www.cel.com

For a complete list of sales offices, representatives and distributors,
Please visit our website: www.cel.com/contactus