



# 2SC5347A

## RF Transistor

12V, 150mA,  $f_T=4.7\text{GHz}$ , NPN Single PCP

ON Semiconductor®

<http://onsemi.com>

### Features

- High-frequency medium output amplification ( $V_{CE}=5\text{V}$ ,  $I_C=50\text{mA}$ )
  - $f_T=4.7\text{GHz}$  typ ( $f=1\text{GHz}$ )
  - $|S_{21e}|^2=8\text{dB}$  typ ( $f=1\text{GHz}$ )
  - $NF=1.8\text{dB}$  typ ( $f=1\text{GHz}$ )

### Specifications

Absolute Maximum Ratings at  $T_a=25^\circ\text{C}$

Parameter	Symbol	Conditions	Ratings	Unit
Collector-to-Base Voltage	$V_{CBO}$		20	V
Collector-to-Emitter Voltage	$V_{CEO}$		12	V
Emitter-to-Base Voltage	$V_{EBO}$		2	V
Collector Current	$I_C$		150	mA
Collector Dissipation	$P_C$	When mounted on ceramic substrate (900mm <sup>2</sup> ×0.8mm)	1.3	W
Junction Temperature	$T_J$		150	°C
Storage Temperature	$T_{stg}$		-55 to +150	°C

Stresses exceeding Maximum Ratings may damage the device. Maximum Ratings are stress ratings only. Functional operation above the Recommended Operating Conditions is not implied. Extended exposure to stresses above the Recommended Operating Conditions may affect device reliability.

### Package Dimensions

unit : mm (typ)  
7007B-004

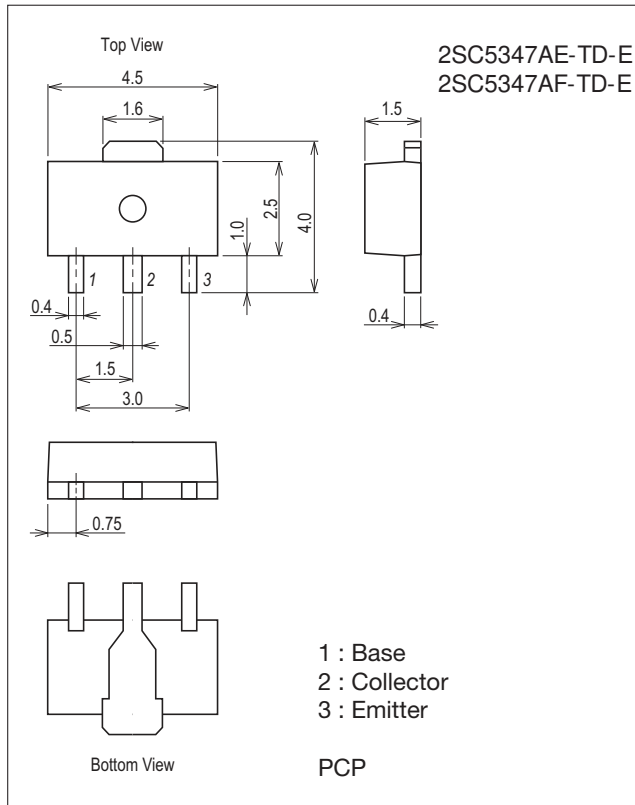

### Product & Package Information

- Package : PCP
- JEITA, JEDEC : SC-62, SOT-89, TO-243
- Minimum Packing Quantity : 1,000 pcs./reel

### Packing Type: TD

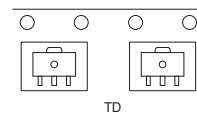

### Marking

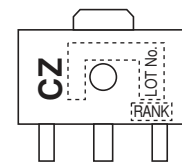

### Electrical Connection

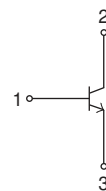

## 2SC5347A

### Electrical Characteristics at Ta=25°C

Parameter	Symbol	Conditions	Ratings			Unit
			min	typ	max	
Collector Cutoff Current	ICBO	V <sub>CB</sub> =10V, I <sub>E</sub> =0A			1.0	μA
Emitter Cutoff Current	IEBO	V <sub>EB</sub> =1V, I <sub>C</sub> =0A			10	μA
DC Current Gain	h <sub>FE</sub>	V <sub>CE</sub> =5V, I <sub>C</sub> =50mA	60*		270*	
Gain-Bandwidth Product	f <sub>T</sub>	V <sub>CE</sub> =5V, I <sub>C</sub> =50mA	3	4.7		GHz
Output Capacitance	Cob	V <sub>CB</sub> =10V, f=1MHz		1.3	2.0	pF
Reverse Transfer Capacitance	Cre				0.9	
Forward Transfer Gain	S <sub>21e</sub>   <sup>2</sup>	V <sub>CE</sub> =5V, I <sub>C</sub> =50mA, f=1GHz	6	8		dB
Noise Figure	NF	V <sub>CE</sub> =5V, I <sub>C</sub> =50mA, f=1GHz		1.8	3.0	dB

\* : The 2SC5347A is classified by 50mA h<sub>FE</sub> as follows :

Rank	D	E	F
h <sub>FE</sub>	60 to 120	90 to 180	135 to 270

### Ordering Information

Device	Package	Shipping	memo
2SC5347AE-TD-E	PCP	1,000pcs./reel	Pb Free
2SC5347AF-TD-E	PCP	1,000pcs./reel	

# 2SC5347A

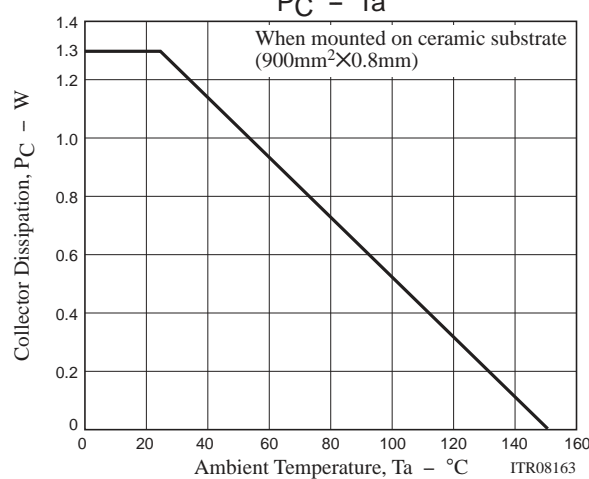
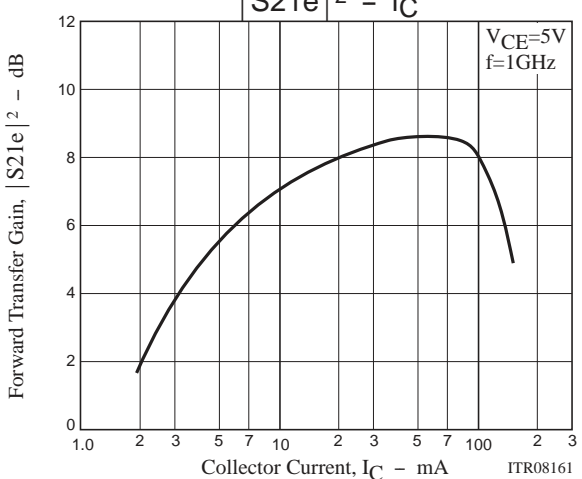
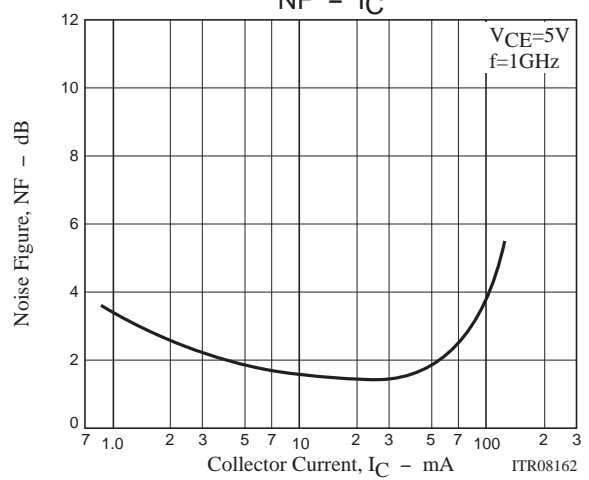
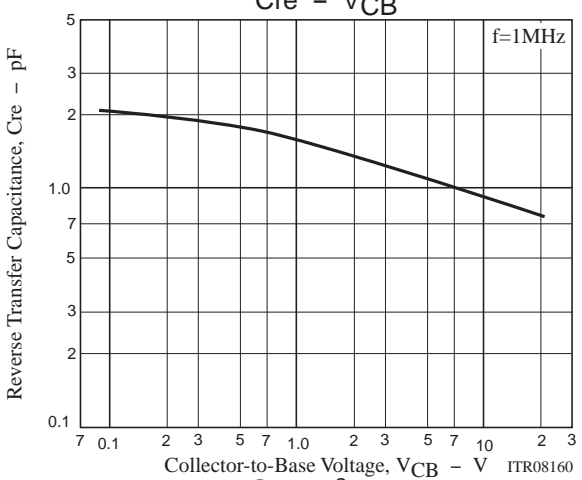
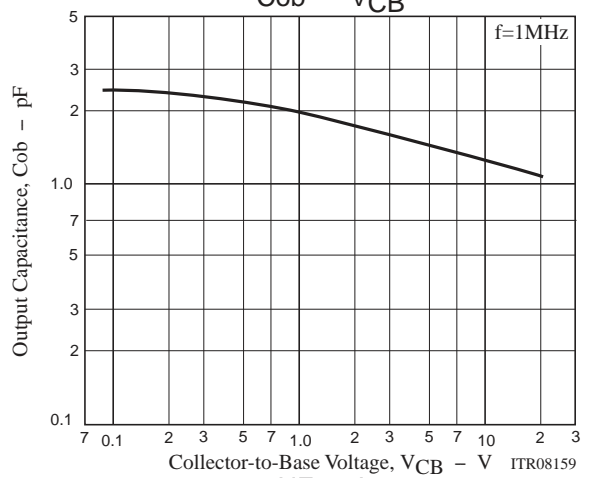
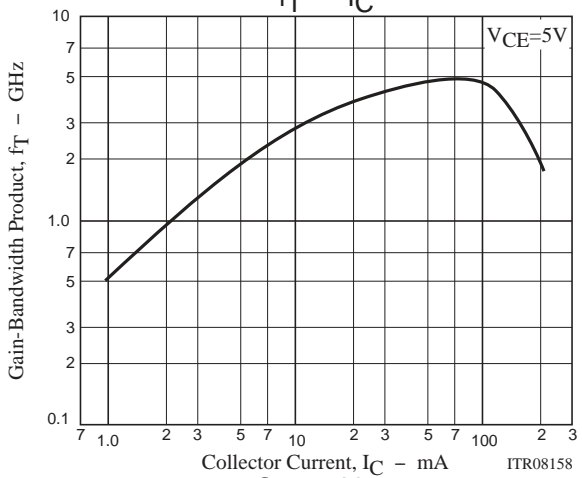
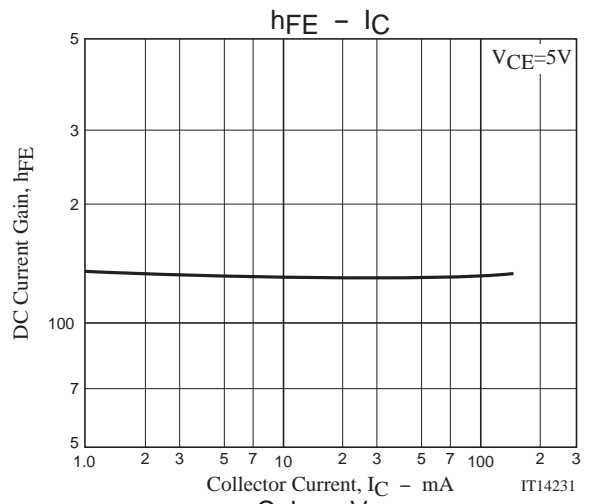
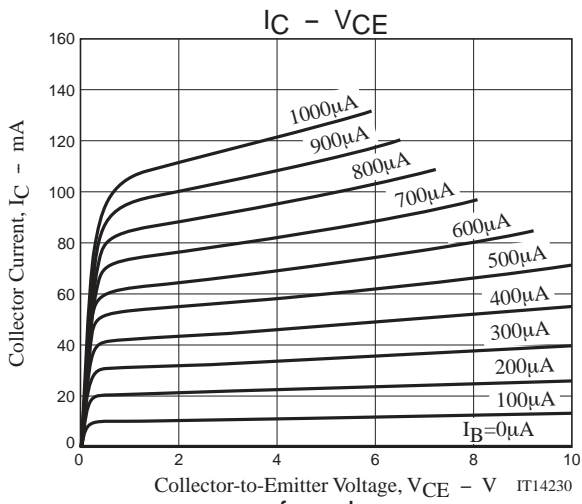

# 2SC5347A

## S Parameter

S11e

f=100MHz to 1200MHz(100MHz Step)

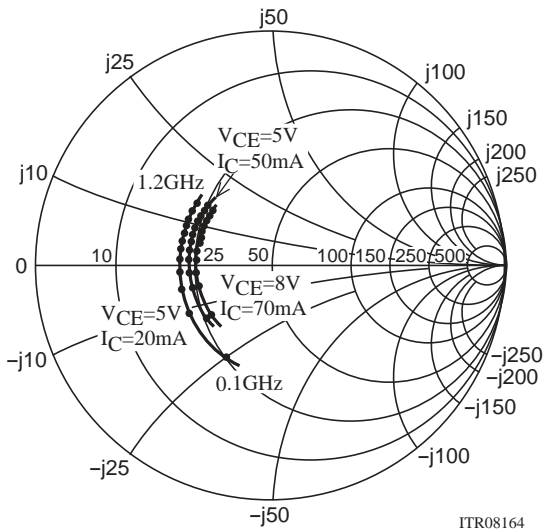

S21e

f=100MHz to 1200MHz(100MHz Step)

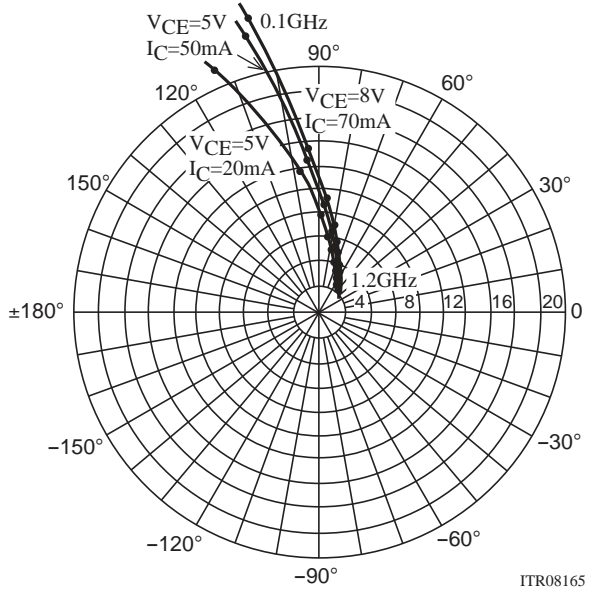

S12e

f=100MHz to 1200MHz(100MHz Step)

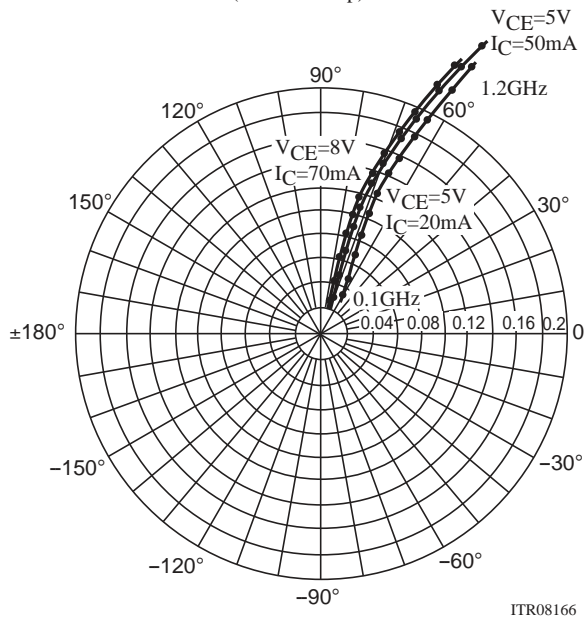

S22e

f=100MHz to 1200MHz(100MHz Step)

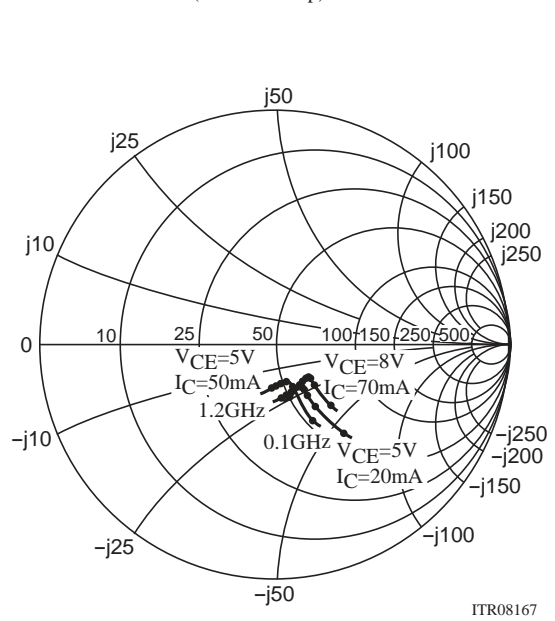

## 2SC5347A

### S Parameters (Common emitter)

$V_{CE}=5V, I_C=50mA, Z_O=50\Omega$

Freq(MHz)	S11	$\angle S11$	S21	$\angle S21$	S12	$\angle S12$	S22	$\angle S22$
100	0.358	-141.0	24.005	105.9	0.027	68.4	0.342	-63.0
200	0.354	-165.7	12.593	93.3	0.047	72.7	0.205	-68.4
300	0.355	-176.8	8.532	86.8	0.068	74.1	0.166	-69.7
400	0.359	174.9	6.428	81.9	0.089	73.7	0.149	-72.3
500	0.359	169.3	5.293	77.6	0.110	72.8	0.145	-75.3
600	0.362	163.9	4.360	73.5	0.130	71.7	0.143	-78.6
700	0.366	158.5	3.774	69.9	0.151	70.2	0.147	-82.1
800	0.364	153.5	3.334	66.4	0.171	68.6	0.151	-85.6
900	0.368	149.8	2.995	62.9	0.191	66.7	0.158	-90.1
1000	0.370	145.3	2.725	59.4	0.210	65.1	0.166	-92.3
1100	0.373	141.5	2.494	56.5	0.230	63.0	0.170	-95.1
1200	0.377	137.6	2.307	53.0	0.248	61.4	0.177	-97.8

$V_{CE}=5V, I_C=20mA, Z_O=50\Omega$

Freq(MHz)	S11	$\angle S11$	S21	$\angle S21$	S12	$\angle S12$	S22	$\angle S22$
100	0.445	-115.4	21.095	113.8	0.032	59.7	0.479	-52.4
200	0.400	-149.6	11.567	97.4	0.049	63.4	0.300	-58.0
300	0.394	-165.7	7.917	89.3	0.066	67.0	0.242	-58.8
400	0.391	-176.5	5.974	82.5	0.085	68.5	0.214	-60.0
500	0.391	176.7	4.845	78.4	0.103	68.8	0.203	-62.2
600	0.392	169.4	4.065	73.9	0.122	68.6	0.199	-64.7
700	0.393	163.8	3.522	70.0	0.141	67.8	0.198	-67.9
800	0.394	158.4	3.114	66.4	0.159	67.1	0.201	-71.2
900	0.396	154.1	2.798	62.5	0.178	65.7	0.204	-74.7
1000	0.399	149.3	2.548	58.9	0.196	64.5	0.212	-78.1
1100	0.403	144.9	2.333	55.5	0.215	62.9	0.218	-81.4
1200	0.408	141.0	2.158	51.8	0.233	61.8	0.224	-84.1

$V_{CE}=8V, I_C=70mA, Z_O=50\Omega$

Freq(MHz)	S11	$\angle S11$	S21	$\angle S21$	S12	$\angle S12$	S22	$\angle S22$
100	0.328	-141.2	25.505	105.1	0.024	70.5	0.348	-50.8
200	0.323	-165.7	13.334	93.0	0.043	75.0	0.233	-48.9
300	0.323	-176.6	9.025	86.7	0.062	75.8	0.204	-47.0
400	0.326	175.1	6.819	81.8	0.081	75.5	0.191	-48.0
500	0.325	169.5	5.481	77.8	0.100	74.5	0.187	-50.5
600	0.328	163.6	4.612	73.7	0.119	73.4	0.185	-53.6
700	0.330	158.4	3.980	70.2	0.139	71.8	0.188	-57.3
800	0.333	153.5	3.524	66.7	0.157	70.4	0.191	-60.9
900	0.335	150.0	3.148	63.3	0.177	68.5	0.198	-65.1
1000	0.341	144.7	2.866	60.0	0.194	67.1	0.204	-69.0
1100	0.345	141.2	2.629	57.0	0.213	65.1	0.208	-72.1
1200	0.348	138.0	2.424	53.4	0.230	62.6	0.215	-75.3

Embossed Taping Specification

2SC5347AE-TD-E, 2SC5347AF-TD-E

1. Packing Format

Package Name	Carrier Tape Type	Maximum Number of devices contained (pcs)			Packing format	
		Reel	Inner box	Outer box	Inner BOX (C-1)	Outer BOX (A-7)
PCP	PCP	1,000	4,000	24,000	4 reels contained Dimensions:mm (external) 183×72×185	6 inner boxes contained Dimensions:mm (external) 440×195×210

Reel label, Inner box label  
(unit : mm)

Outer box label  
It is a label at the time of factory shipments.  
The form of a label may change in physical distribution process.

Packing method

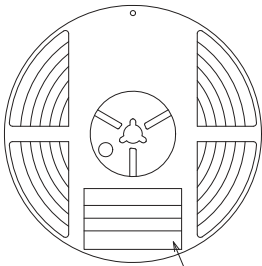

Reel label

Type No.  
LOT No.  
Quantity  
Origin

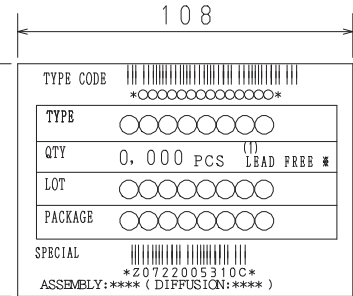
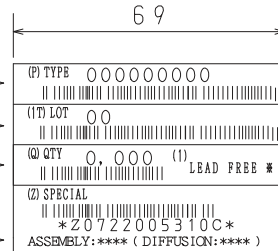

NOTE (1)

The LEAD FREE \* description shows that the surface treatment of the terminal is lead free.

Label	JEITA Phase
LEAD FREE 3	JEITA Phase 3A
LEAD FREE 4	JEITA Phase 3

2. Taping configuration

2-1. Carrier tape size (unit:mm)

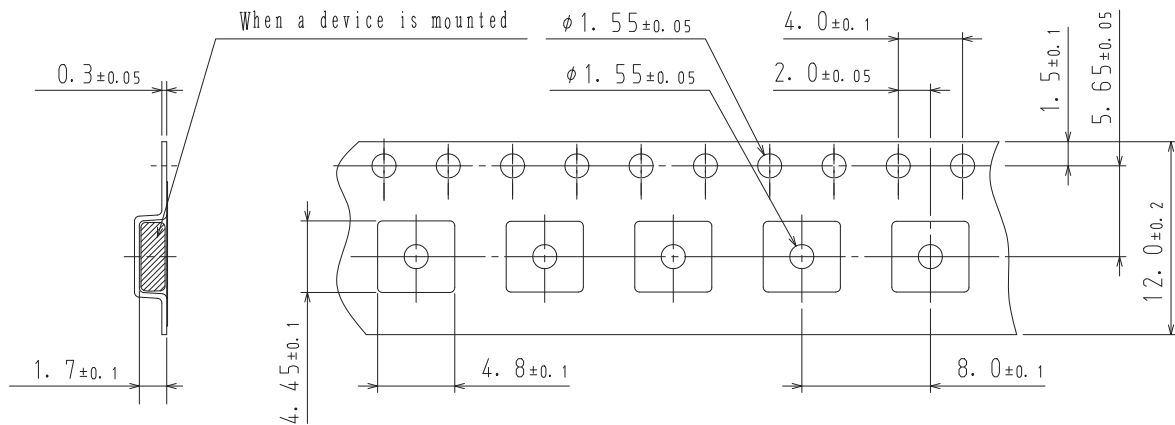

2-2. Device placement direction

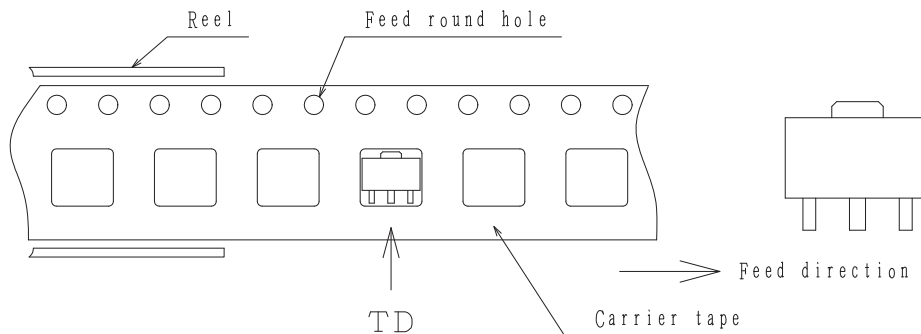

Those with pin 1 index on the feed hole side.....TD

# 2SC5347A

## Outline Drawing

2SC5347AE-TD-E, 2SC5347AF-TD-E

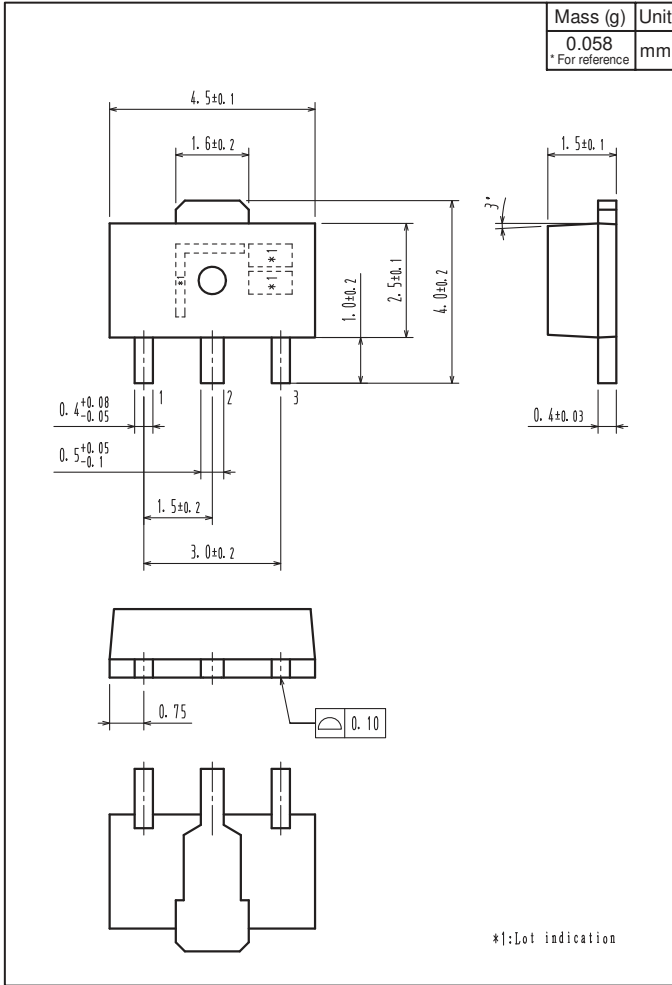

## Land Pattern Example

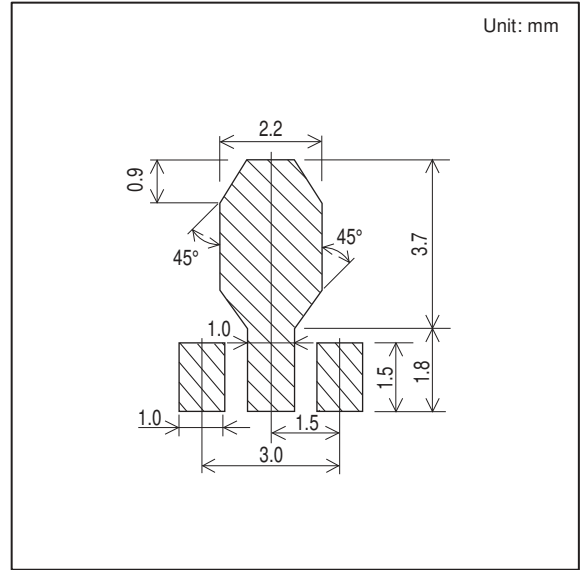

ON Semiconductor and the ON logo are registered trademarks of Semiconductor Components Industries, LLC (SCILLC). SCILLC owns the rights to a number of patents, trademarks, copyrights, trade secrets, and other intellectual property. A listing of SCILLC's product/patent coverage may be accessed at [www.onsemi.com/site/pdf/Patent-Marking.pdf](http://www.onsemi.com/site/pdf/Patent-Marking.pdf). SCILLC reserves the right to make changes without further notice to any products herein. SCILLC makes no warranty, representation or guarantee regarding the suitability of its products for any particular purpose, nor does SCILLC assume any liability arising out of the application or use of any product or circuit, and specifically disclaims any and all liability, including without limitation special, consequential or incidental damages. "Typical" parameters which may be provided in SCILLC data sheets and/or specifications can and do vary in different applications and actual performance may vary over time. All operating parameters, including "Typicals" must be validated for each customer application by customer's technical experts. SCILLC does not convey any license under its patent rights nor the rights of others. SCILLC products are not designed, intended, or authorized for use as components in systems intended for surgical implant into the body, or other applications intended to support or sustain life, or for any other application in which the failure of the SCILLC product could create a situation where personal injury or death may occur. Should Buyer purchase or use SCILLC products for any such unintended or unauthorized application, Buyer shall indemnify and hold SCILLC and its officers, employees, subsidiaries, affiliates, and distributors harmless against all claims, costs, damages, and expenses, and reasonable attorney fees arising out of, directly or indirectly, any claim of personal injury or death associated with such unintended or unauthorized use, even if such claim alleges that SCILLC was negligent regarding the design or manufacture of the part. SCILLC is an Equal Opportunity/Affirmative Action Employer. This literature is subject to all applicable copyright laws and is not for resale in any manner.