

XS4P18AB120

Inductive proximity sensors XS, inductive sensor XS4 M18, L41mm, PBT, Sn8mm, 12...24 VDC, cable 2 m



Main

Range of Product	Telemecanique Inductive proximity sensors XS
Series name	Application
Sensor Type	Inductive proximity sensor
Electrical circuit type	Analog output
Sensor name	XS4
Sensor design	Cylindrical M18
Size	41 mm
Body type	Fixed
Detector flush mounting acceptance	Non flush mountable
Material	Plastic
Type of output signal	Analogue
Wiring Technique	2-wire
[Sn] nominal sensing distance	0.31 in (8 mm)
Output circuit type	DC
Analogue output range	4...20 mA
Electrical connection	Cable
Cable length	6.56 ft (2 m)
[Us] rated supply voltage	12...24 V DC
IP degree of protection	IP67 conforming to IEC 60529

Complementary

Thread type	M18 x 1
Detection face	Frontal
Front material	PPS
Enclosure Material	PBT
Operating zone	0.03...0.31 in (0.8...8 mm)
Repeat accuracy	<= 3% of Sr
Linearity error	+/- 2 mA
Cable composition	3 x 0.34 mm ²
Wire insulation material	PvR
Supply voltage limits	10...38 V DC
Switching frequency	<= 500 Hz
Current consumption	4 mA no-load
Maximum output current drift	10 %
Marking	CE
Threaded length	1.02 in (26 mm)
Height	0.71 in (18 mm)
Length	1.61 in (41 mm)
Net Weight	0.18 lb(US) (0.08 kg)

The information provided in this documentation contains general descriptions and/or technical characteristics of the performance of the products contained herein. This documentation is not intended as a substitute for and is not to be used for determining suitability or reliability of these products for specific user applications. It is the duty of any such user or integrator to perform the appropriate and complete risk analysis, evaluation and testing of the products with respect to the relevant specific application or use thereof. Neither Schneider Electric Industries SAS nor any of its affiliates or subsidiaries shall be responsible or liable for misuse of the information contained herein.

Environment

Product Certifications	CSA UL
Ambient air temperature for operation	-13...158 °F (-25...70 °C)

Ordering and shipping details

Category	22486 - SENSORS, PROXIMITY
Discount Schedule	DS2
GTIN	3389110336184
Nbr. of units in pkg.	1
Package weight(Lbs)	2.86 oz (81 g)
Returnability	Yes
Country of origin	FR

Packing Units

Unit Type of Package 1	PCE
Package 1 Height	1.61 in (4.1 cm)
Package 1 width	3.74 in (9.5 cm)
Package 1 Length	5.12 in (13 cm)
Unit Type of Package 2	S03
Number of Units in Package 2	44
Package 2 Weight	8.91 lb(US) (4.04 kg)
Package 2 Height	11.81 in (30 cm)
Package 2 width	11.81 in (30 cm)
Package 2 Length	15.75 in (40 cm)
Package 3 Height	11.81 in (30 cm)

Offer Sustainability

Sustainable offer status	Green Premium product
California proposition 65	WARNING: This product can expose you to chemicals including: Diisononyl phthalate (DINP), which is known to the State of California to cause cancer, and Di-isodecyl phthalate (DIDP), which is known to the State of California to cause birth defects or other reproductive harm. For more information go to www.P65Warnings.ca.gov
REACH Regulation	REACH Declaration
EU RoHS Directive	Pro-active compliance (Product out of EU RoHS legal scope) EU RoHS Declaration
Mercury free	Yes
RoHS exemption information	Yes
Environmental Disclosure	Product Environmental Profile
Circularity Profile	End Of Life Information

Contractual warranty

Warranty	18 months
----------	-----------

Dimensions

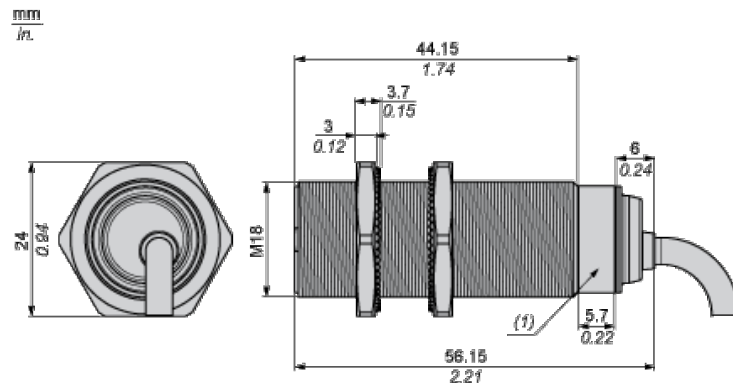

(1) LED

Minimum Mounting Distances

Side by side

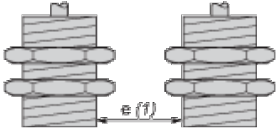

e (1) 32 mm/1.26 in.

≥

Face to face

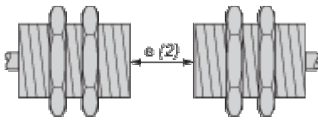

e (2) 96 mm/3.78 in.

≥

Facing a metal object

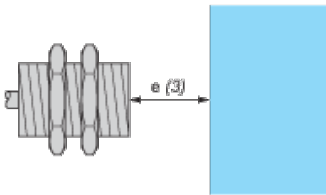

e (3) 24 mm/0.94 in.

≥

Mounted in a metal support

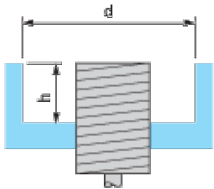

d ≥ 56 mm/2.20 in.

h ≥ 16 mm/0.63 in.

Mounting

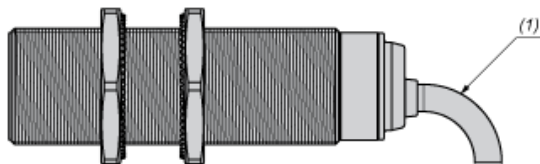

(1) Bending cable: 4 x external cable diameter

Wiring Schemes

2-Wire connection

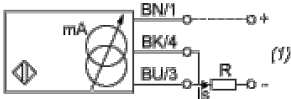

(1) Output current

BN : Brown

BK : Black

BU : Blue

	Output current	Load impedance value
12 V	4...20 mA	$R \leq 8.2 \Omega$
24 V	4...20 mA	$R \leq 470 \Omega$

Output Curves

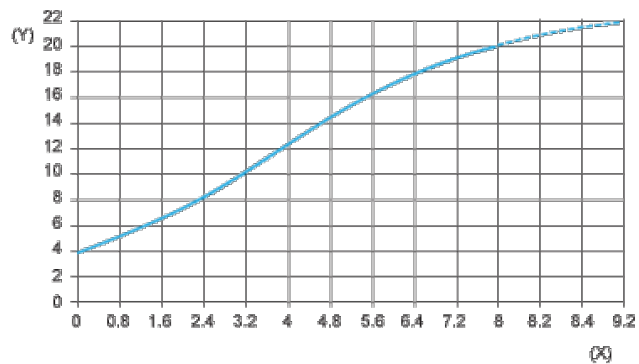

(Y) Is (mA)

(X) Sensors - object distance (mm)