

5-100526-4 ✓ ACTIVE

Z-PACK | Z-PACK 2mm HM

TE Internal #: 5-100526-4

Backplane Coding Keys, Receptacle, Coding Key Number 1346, Z-PACK 2mm HM

[View on TE.com >](#)



Connectors > PCB Connectors > Backplane Connectors > Backplane Coding Keys

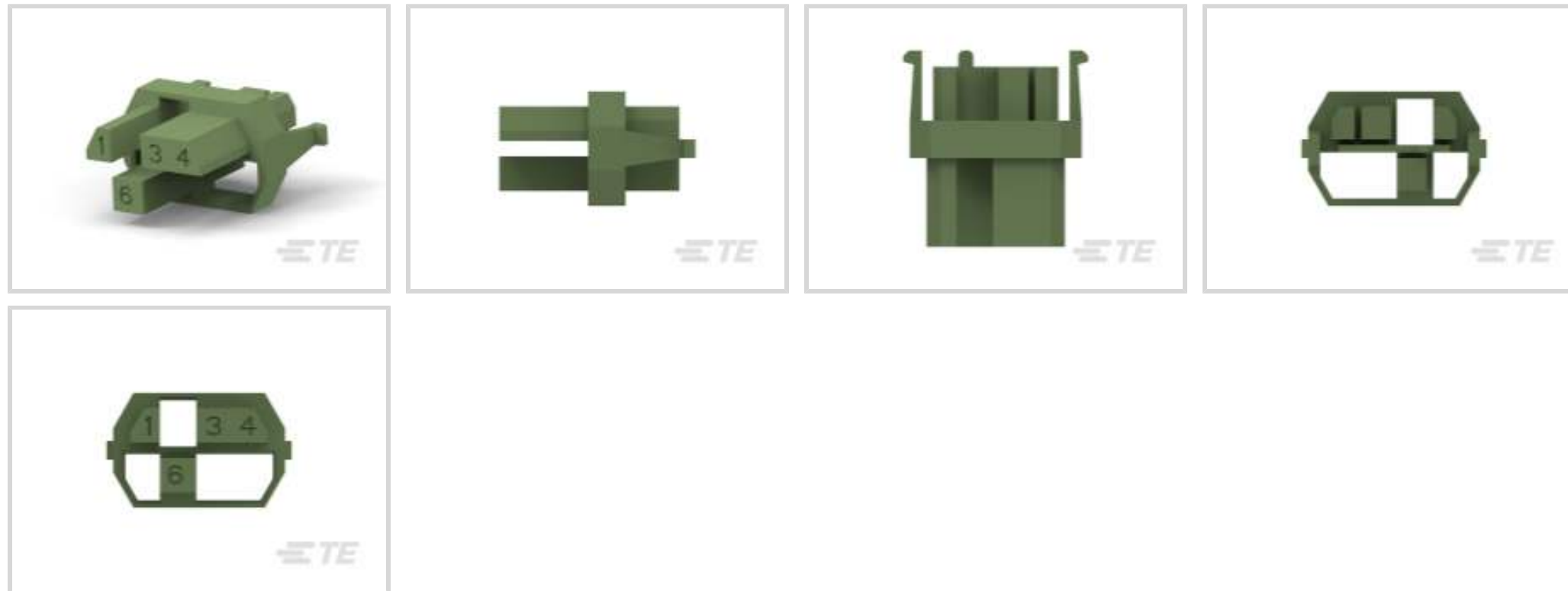

Compatible With Connector Style: **Receptacle**

Coding Key Number: **1346**

## Features

### Body Features

Coding Key Color	Reseda Green
------------------	--------------

### Usage Conditions

Compatible With Backplane Connector Type	Type A, Type D, Type L, Type M
Compatible With Connector Style	Receptacle

### Packaging Features

Packaging Quantity	500
Packaging Method	Bag

### Other

Coding Key Number	1346
-------------------	------

## Product Compliance

[For compliance documentation, visit the product page on TE.com>](#)

EU RoHS Directive 2011/65/EU	Compliant
EU ELV Directive 2000/53/EC	Compliant
China RoHS 2 Directive MIIT Order No 32, 2016	No Restricted Materials Above Threshold
EU REACH Regulation (EC) No. 1907/2006	Current ECHA Candidate List: JUNE 2023 (235)



Candidate List Declared Against: JAN 2023  
(233)

Does not contain REACH SVHC

Halogen Content

Low Halogen - Br, Cl, F, I < 900 ppm per homogenous material. Also BFR/CFR/PVC Free

Solder Process Capability

Not applicable for solder process capability

Product Compliance Disclaimer

This information is provided based on reasonable inquiry of our suppliers and represents our current actual knowledge based on the information they provided. This information is subject to change. The part numbers that TE has identified as EU RoHS compliant have a maximum concentration of 0.1% by weight in homogenous materials for lead, hexavalent chromium, mercury, PBB, PBDE, DBP, BBP, DEHP, DIBP, and 0.01% for cadmium, or qualify for an exemption to these limits as defined in the Annexes of Directive 2011/65/EU (RoHS2). Finished electrical and electronic equipment products will be CE marked as required by Directive 2011/65/EU. Components may not be CE marked. Additionally, the part numbers that TE has identified as EU ELV compliant have a maximum concentration of 0.1% by weight in homogenous materials for lead, hexavalent chromium, and mercury, and 0.01% for cadmium, or qualify for an exemption to these limits as defined in the Annexes of Directive 2000/53/EC (ELV). Regarding the REACH Regulation, the information TE provides on SVHC in articles for this part number is based on the latest European Chemicals Agency (ECHA) 'Guidance on requirements for substances in articles' posted at this URL: <https://echa.europa.eu/guidance-documents/guidance-on-reach>

## Compatible Parts



## Also in the Series | Z-PACK 2mm HM

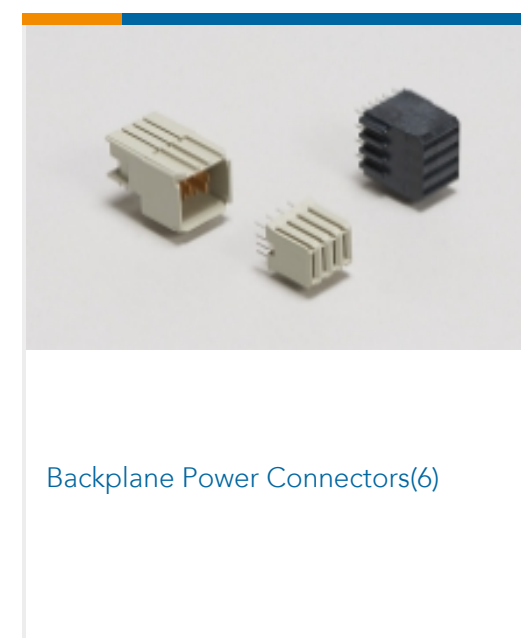
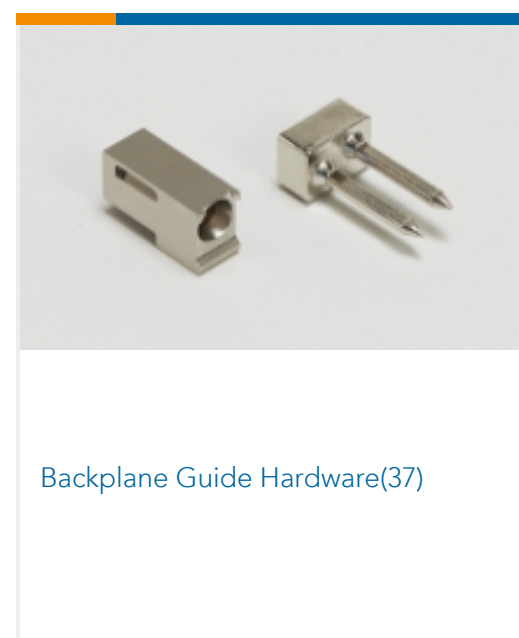
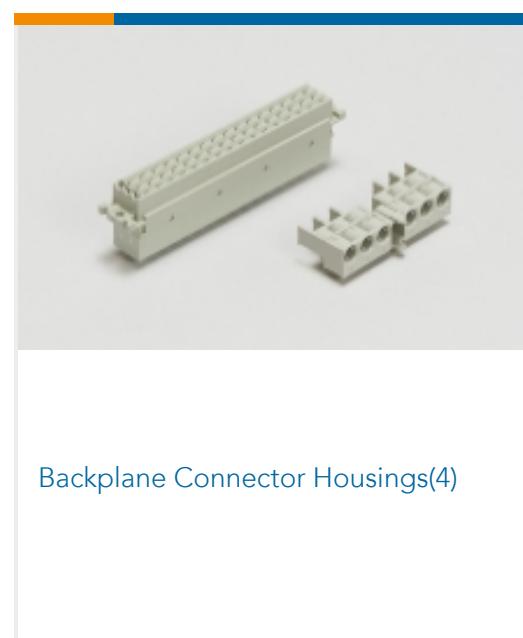
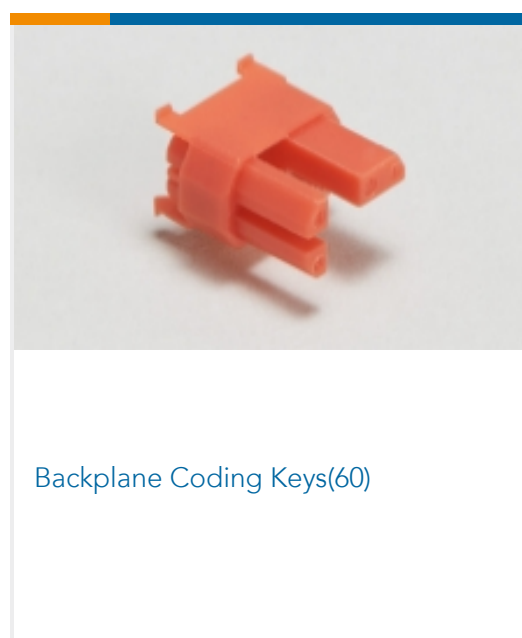



Board-to-Board Connector Contacts(2)

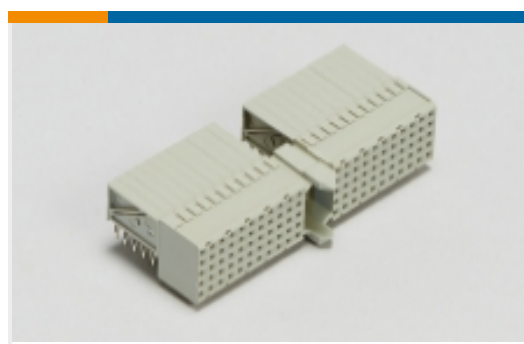

Hard Metric Backplane Connectors (269)

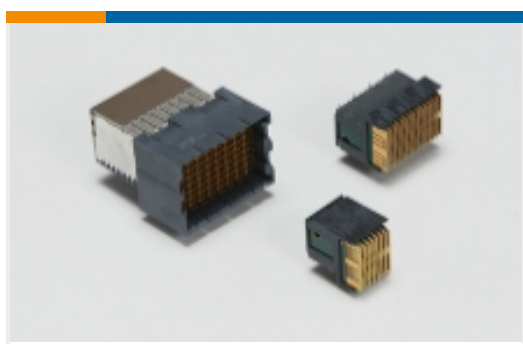

High Speed Backplane Connectors(1)



Insertion & Extraction Tools(2)

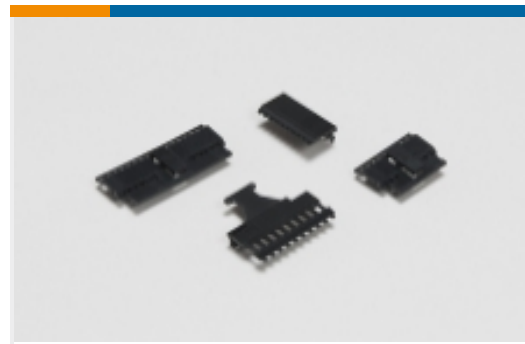

PCB Connector Covers(4)



PCB Connector Shrouds(39)



PCB Ferrules & Shields(19)



Rectangular Power Connectors(87)

## Customers Also Bought



TE Part #5352171-1  
Z-PACK/B19 RAF 95P

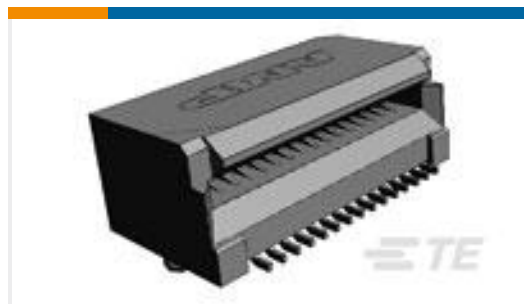

TE Part #788862-2  
PT30 XFP CONNECTOR



TE Part #5223955-2  
TE UPM Ver Receptacle 3P STD Power



TE Part #1775862-2  
mSATA/mini PCI-E 5.2H Type I G/F

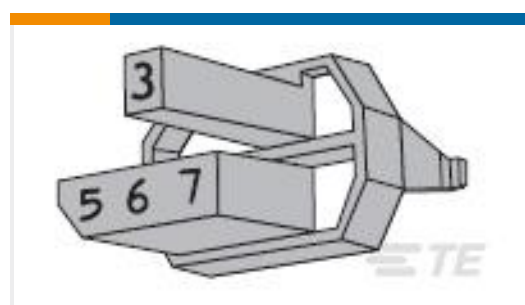

TE Part #6-100526-1  
Z-PACK F.CODING KEY



TE Part #32859-1  
BUDGET,RING,26-22,8,UNPLTD



TE Part #2-2176308-0  
RP 1E 0.1W 210K 0.1% 25PPM 5K RL



TE Part #2-767004-2  
MICT,RECPT,038,ASSY,.025,REC

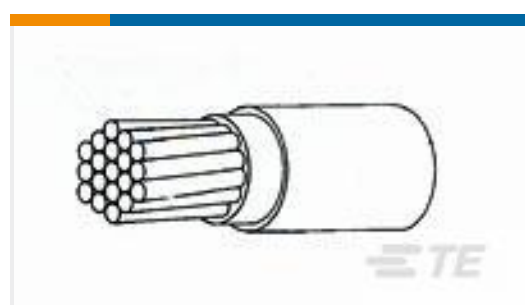

TE Part #2820203012  
44A0111-20-0



TE Part #623163-000  
D-148-0208

## Documents



### Product Drawings

#### CODING DEV INSRT COLOR GREEN

English

---

### CAD Files

#### 3D PDF

3D

#### Customer View Model

[ENG\\_CVM\\_CVM\\_5-100526-4\\_E.2d\\_dxf.zip](#)

English

#### Customer View Model

[ENG\\_CVM\\_CVM\\_5-100526-4\\_E.3d\\_igs.zip](#)

English

#### Customer View Model

[ENG\\_CVM\\_CVM\\_5-100526-4\\_E.3d\\_stp.zip](#)

English

By downloading the CAD file I accept and agree to the [Terms and Conditions](#) of use.

---

### Product Specifications

#### Application Specification

English

---

### Product Environmental Compliance

[MD\\_5-100526-4\\_02262016624\\_dmtec](#)

English

[MD\\_5-100526-4\\_02262016624\\_dmtec](#)

English