

5-2232264-6 ✓ ACTIVE



Power Triple Lock

TE Internal #: 5-2232264-6

Rectangular Power Connectors, Housing, Cap, Wire-to-Wire, 12 Position, 6 mm [.236 in] Centerline, Wire & Cable, UL 94V-0, Power Triple Lock

[View on TE.com >](#)

Connectors > Power Connectors > Rectangular Power > Rectangular Power Connectors > POWER TRIPLE LOCK: Glow Wire Cap

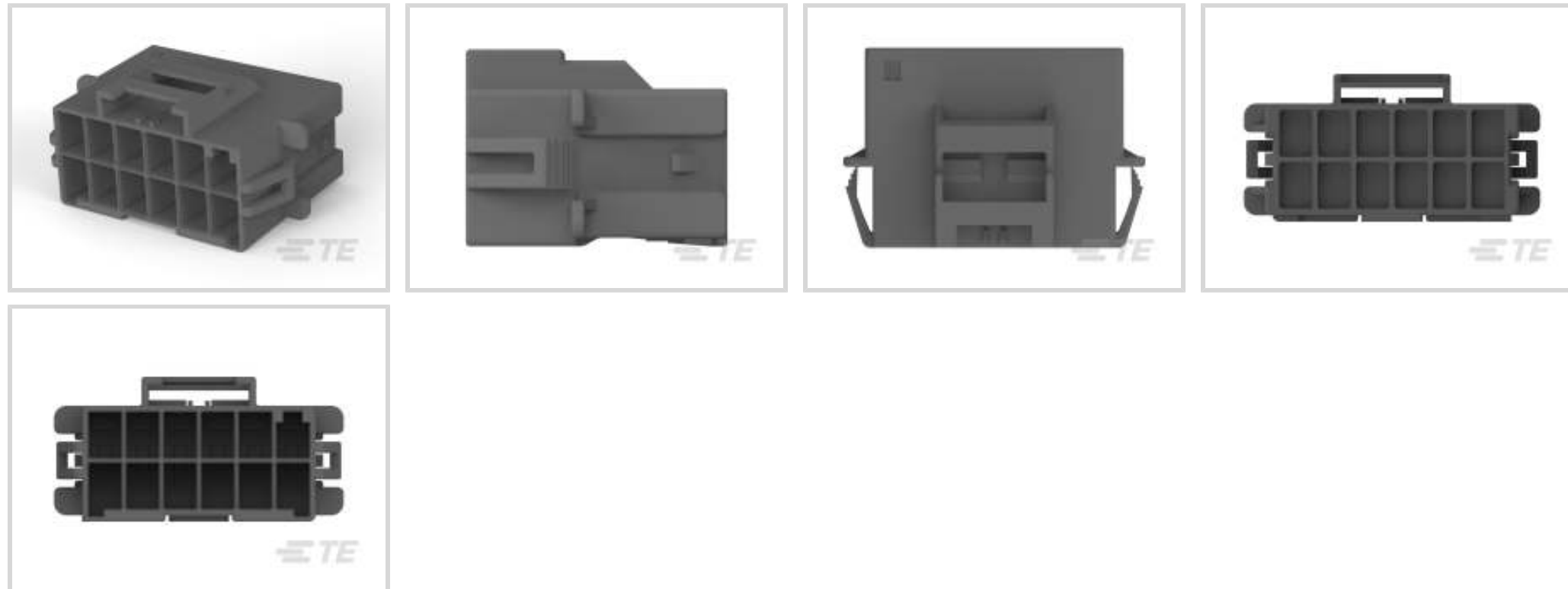

Rectangular Power Connector Type: **Housing**

Connector & Housing Type: **Cap**

Connector System: **Wire-to-Wire**

Number of Positions: **12**

Centerline (Pitch): **6 mm [.236 in]**

[All POWER TRIPLE LOCK: Glow Wire Cap \(44\)](#)

Features

Product Type Features

Rectangular Power Connector Type	Housing
Connector & Housing Type	Cap
Connector System	Wire-to-Wire
Sealable	No
Connector & Contact Terminates To	Wire & Cable

Configuration Features

Number of Positions	12
Number of Power Positions	12
Number of Rows	2

Electrical Characteristics

Operating Voltage	600 VDC
-------------------	---------

Body Features



Cable Exit Angle	180°
------------------	------

Connector & Keying Code	A
-------------------------	---

Contact Features

Contact Layout	Matrix
----------------	--------

Contact Retention Within Housing	Without
----------------------------------	---------

Contact Type	Tab
--------------	-----

Termination Features

Termination Method to Wire & Cable	Crimp
------------------------------------	-------

Mechanical Attachment

Panel Mount Feature	With
---------------------	------

Panel Mount Feature Type	Latches
--------------------------	---------

Connector Mounting Type	Panel Mount
-------------------------	-------------

Housing Features

Centerline (Pitch)	6 mm [.236 in]
--------------------	----------------

Housing Color	Gray
---------------	------

Housing Material	Nylon GF
------------------	----------

Dimensions

Panel Thickness (Recommended)	1 – 2 mm [.039 – .079 in]
-------------------------------	---------------------------

Connector Height	23.05 mm
------------------	----------

Row-to-Row Spacing	8.1 mm [.319 in]
--------------------	------------------

Usage Conditions

Operating Temperature Range	-55 – 140 °C [-67 – 284 °F]
-----------------------------	-----------------------------

Operation/Application

Circuit Application	Power
---------------------	-------

Identification Marking

Circuit Identification Feature	With
--------------------------------	------

Industry Standards

UL Rating	Recognized
-----------	------------

Agency/Standard	UL, VDE
-----------------	---------

Approved Standards	UL E28476
--------------------	-----------

UL Flammability Rating	UL 94V-0
------------------------	----------



Glow Wire Rating	GWT 750°C (Without Flame)
------------------	---------------------------

Packaging Features

Packaging Method	Carton
------------------	--------

Other

Power Connectors Comment	Complies with IEC 61984 Specification
--------------------------	---------------------------------------

Product Compliance

[For compliance documentation, visit the product page on TE.com>](#)

EU RoHS Directive 2011/65/EU	Compliant
------------------------------	-----------

EU ELV Directive 2000/53/EC	Compliant
-----------------------------	-----------

China RoHS 2 Directive MIIT Order No 32, 2016	No Restricted Materials Above Threshold
---	---

EU REACH Regulation (EC) No. 1907/2006	Current ECHA Candidate List: JUNE 2023 (235) Candidate List Declared Against: JUNE 2023 (235) Does not contain REACH SVHC
--	---

Halogen Content	Not Low Halogen - contains Br or Cl > 900 ppm.
-----------------	--

Solder Process Capability	Not reviewed for solder process capability
---------------------------	--

Product Compliance Disclaimer

This information is provided based on reasonable inquiry of our suppliers and represents our current actual knowledge based on the information they provided. This information is subject to change. The part numbers that TE has identified as EU RoHS compliant have a maximum concentration of 0.1% by weight in homogenous materials for lead, hexavalent chromium, mercury, PBB, PBDE, DBP, BBP, DEHP, DIBP, and 0.01% for cadmium, or qualify for an exemption to these limits as defined in the Annexes of Directive 2011/65/EU (RoHS2). Finished electrical and electronic equipment products will be CE marked as required by Directive 2011/65/EU. Components may not be CE marked. Additionally, the part numbers that TE has identified as EU ELV compliant have a maximum concentration of 0.1% by weight in homogenous materials for lead, hexavalent chromium, and mercury, and 0.01% for cadmium, or qualify for an exemption to these limits as defined in the Annexes of Directive 2000/53/EC (ELV). Regarding the REACH Regulation, the information TE provides on SVHC in articles for this part number is based on the latest European Chemicals Agency (ECHA) 'Guidance on requirements for substances in articles' posted at this URL: <https://echa.europa.eu/guidance-documents/guidance-on-reach>

Compatible Parts



TE Part # 1971778-6
PTL TPA HIGH TEMP 2 x 6 BLACK



TE Part # CAT-P87074-T111
Tab Contact — POWER TRIPLE LOCK

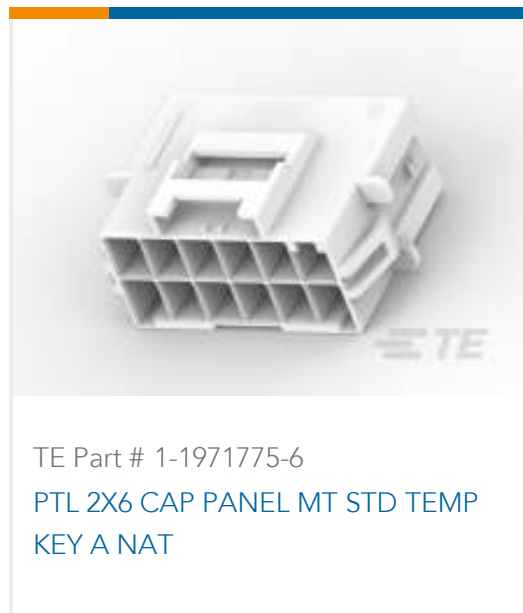

TE Part # 1-1971775-6
PTL 2X6 CAP PANEL MT STD TEMP
KEY A NAT



TE Part # 1971789-1
CPA



TE Part # 5-2232266-6
PTL 2X6 PLUG HSG GLW WIRE KEY A
DGR

Also in the Series | **Power Triple Lock**

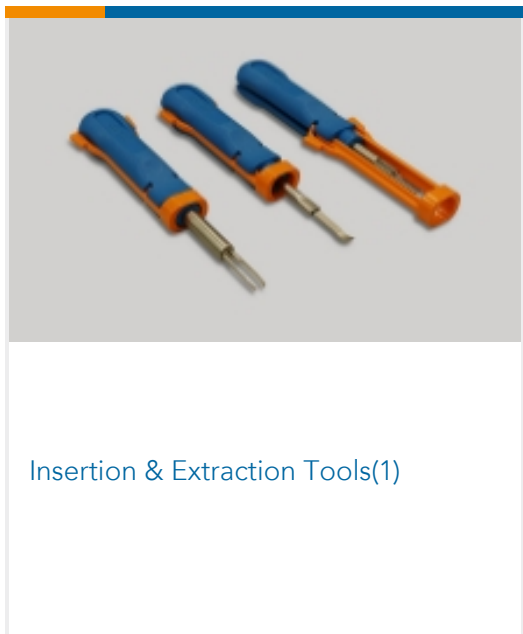

Insertion & Extraction Tools(1)

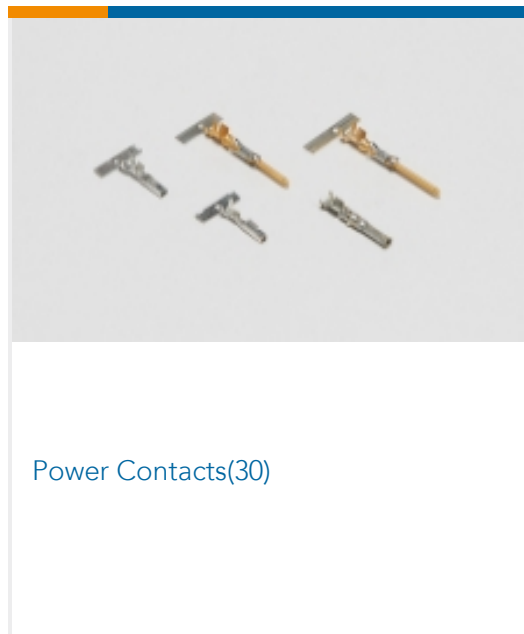

Power Contacts(30)

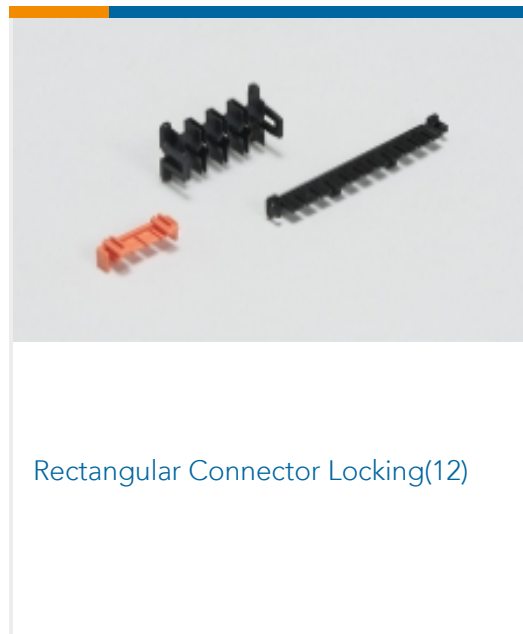

Rectangular Connector Locking(12)



Rectangular Power Connectors(300)

Customers Also Bought



TE Part #206070-8
CABLE CLAMP KIT #17



TE Part #DT04-2P
REC, 2P, GRY, N



TE Part #DT06-2S
PLG, 2P, GRY, N



TE Part #W2P
Wedgelocks: DEUTSCH DT



TE Part #0460-202-16141
DEUTSCH Solid Contacts

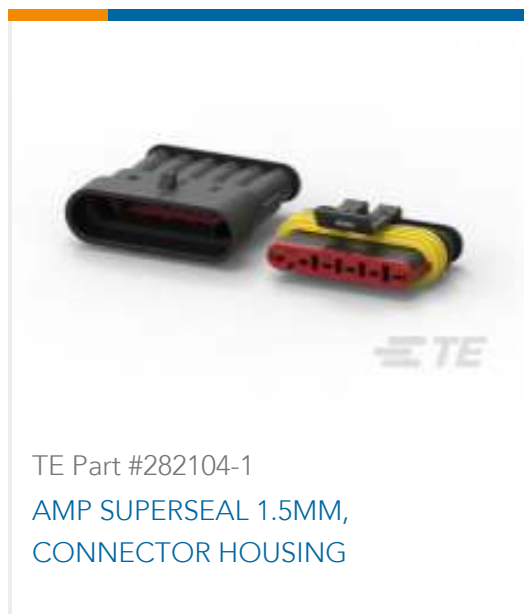

TE Part #282104-1
AMP SUPERSEAL 1.5MM,
CONNECTOR HOUSING

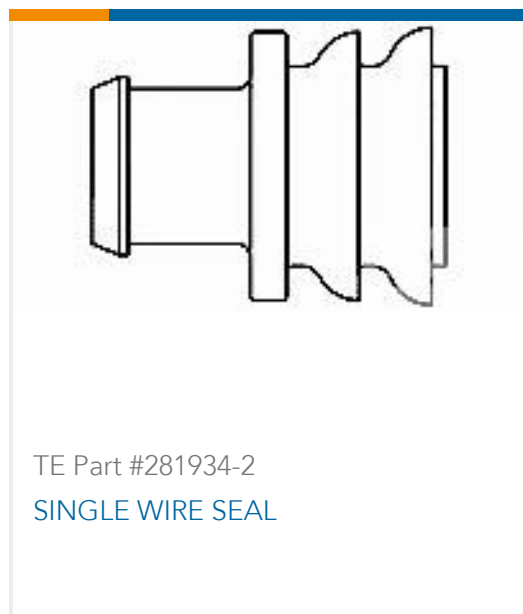

TE Part #281934-2
SINGLE WIRE SEAL



Documents

Product Drawings

[PTL 2X6 CAP PANEL MT GLW WIRE KEY A DGR](#)

English

CAD Files

[3D PDF](#)

3D

Customer View Model

[ENG_CVM_CVM_5-2232264-6_B.2d_dxf.zip](#)

English

Customer View Model

[ENG_CVM_CVM_5-2232264-6_B.3d_igs.zip](#)

English

Customer View Model

[ENG_CVM_CVM_5-2232264-6_B.3d_stp.zip](#)

English

By downloading the CAD file I accept and agree to the [Terms and Conditions](#) of use.

Datasheets & Catalog Pages

[1-1773734-9 TE Power Triple Lock Quick Reference Guide - German](#)

German

[9-1773465-1 Power Triple Lock QRG](#)

English

Product Specifications

[Application Specification](#)

English

Product Environmental Compliance

[MD_5-2232264-6_05062016132_dmtec](#)

English

[MD_5-2232264-6_05062016132_dmtec](#)

English

Agency Approvals

[VDE Certificate](#)

English

[VDE Certificate](#)

English