

CKTS	DIM A	DIM B
2	.200/5.08	.100/2.54
3	.300/7.62	.200/5.08
4	.400/10.16	.300/7.62
5	.500/12.70	.400/10.16
6	.600/15.24	.500/12.70
7	.700/17.78	.600/15.24
8	.800/20.32	.700/17.78
9	.900/22.86	.800/20.32
10	1.000/25.40	.900/22.86
11	1.100/27.94	1.000/25.40
12	1.200/30.48	1.100/27.94
13	1.300/33.02	1.200/30.48
14	1.400/35.56	1.300/33.02
15	1.500/38.10	1.400/35.56
16	1.600/40.64	1.500/38.10
17	1.700/43.18	1.600/40.64
18	1.800/45.72	1.700/43.18
19	1.900/48.26	1.800/45.72
20	2.000/50.80	1.900/48.26
21	2.100/53.34	2.000/50.80
22	2.200/55.88	2.100/53.34
23	2.300/58.42	2.200/55.88
24	2.400/60.96	2.300/58.42
25	2.500/63.50	2.400/60.96
26	2.600/66.04	2.500/63.50
27	2.700/68.58	2.600/66.04
28	2.800/71.12	2.700/68.58
29	2.900/73.66	2.800/71.12
30	3.000/76.20	2.900/73.66
31	3.100/78.74	3.000/76.20
32	3.200/81.28	3.100/78.74
33	3.300/83.82	3.200/81.28
34	3.400/86.36	3.300/83.82
35	3.500/88.90	3.400/86.36
36	3.600/91.44	3.500/88.90

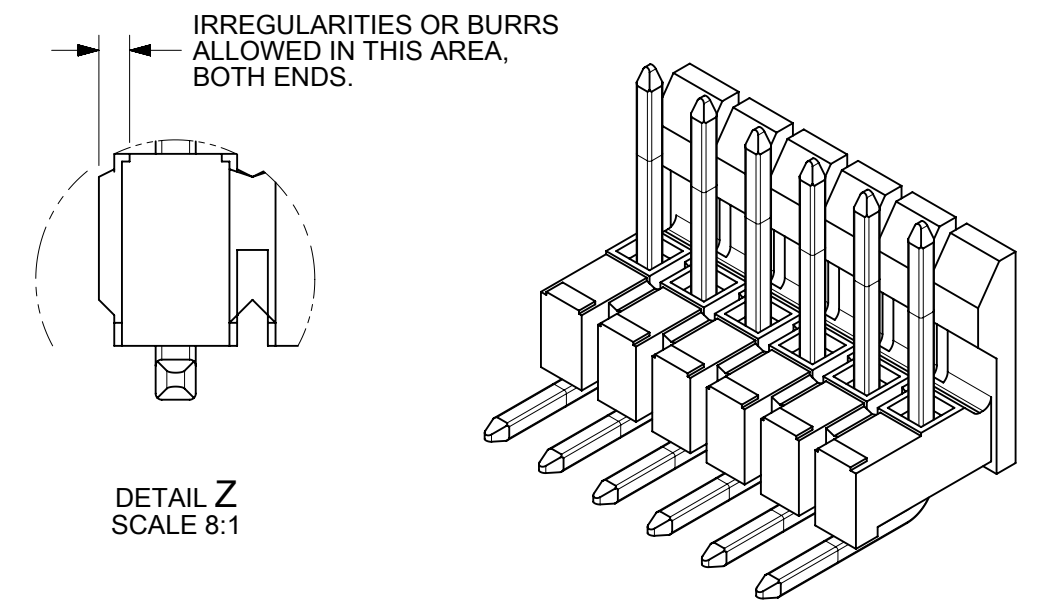

- NOTES:
- MATERIAL: GLASS FILLED NYLON, 94V-0, COLOR: BLACK
  - FINISH:
    - (154) OVERALL TIN: .000100/0.00254 MIN, OVER .000050/0.00127 MIN NICKEL.
    - (208) SELECT GOLD: .000015/0.00038 MIN, SELECT TIN: .000100/0.00254 MIN, OVERALL NICKEL UNDERPLATE: .000050/0.00127 MIN.
    - (228) SELECT GOLD: .000030/0.00076 MIN, SELECT TIN: .000100/0.00254 MIN, OVERALL NICKEL UNDERPLATE: .000050/0.00127 MIN.
  - PRODUCT SPECIFICATION: PS-10-07.
  - PACKAGING INFORMATION: SEE TABLES
  - KINK PIN OPTION NOT RECOMMENDED FOR 2 CIRCUIT PARTS. HOLE SIZE MAY NEED TO BE ADJUSTED ON 2 CIRCUIT PARTS WITH KINK OPTION FOR PROPER INSERTION INTO THE PCB. SEE SMES-42003 OR SMES-43703-0000 FOR ADDITIONAL INFORMATION ON KINK PIN DIRECTION AND PLACEMENT.
  - HEADERS ARE NOT STACKABLE ON .100/2.54 CENTERS.
  - SOLDERABILITY PER SMES-152.
  - PIN PUSH OUT FORCE: 3 LBS. MIN.
  - ABRASION MARKS ON BACK WALL SURFACE ARE PERMISSIBLE.
  - PARTS CONFORM TO CLASS 'B' REQUIREMENTS OF COSMETIC SPECIFICATION PS-45499-002.
  - PIN TIP DIMENSIONS ARE SHOWN FOR REFERENCE ONLY. DIMENSIONS APPLY PRIOR TO PLATING OR ASSEMBLY.
  - FIRST AND LAST CIRCUIT BACKWALLS MUST BE REMOVED WHEN MATING TO A PART WITH POLARIZING RIBS.

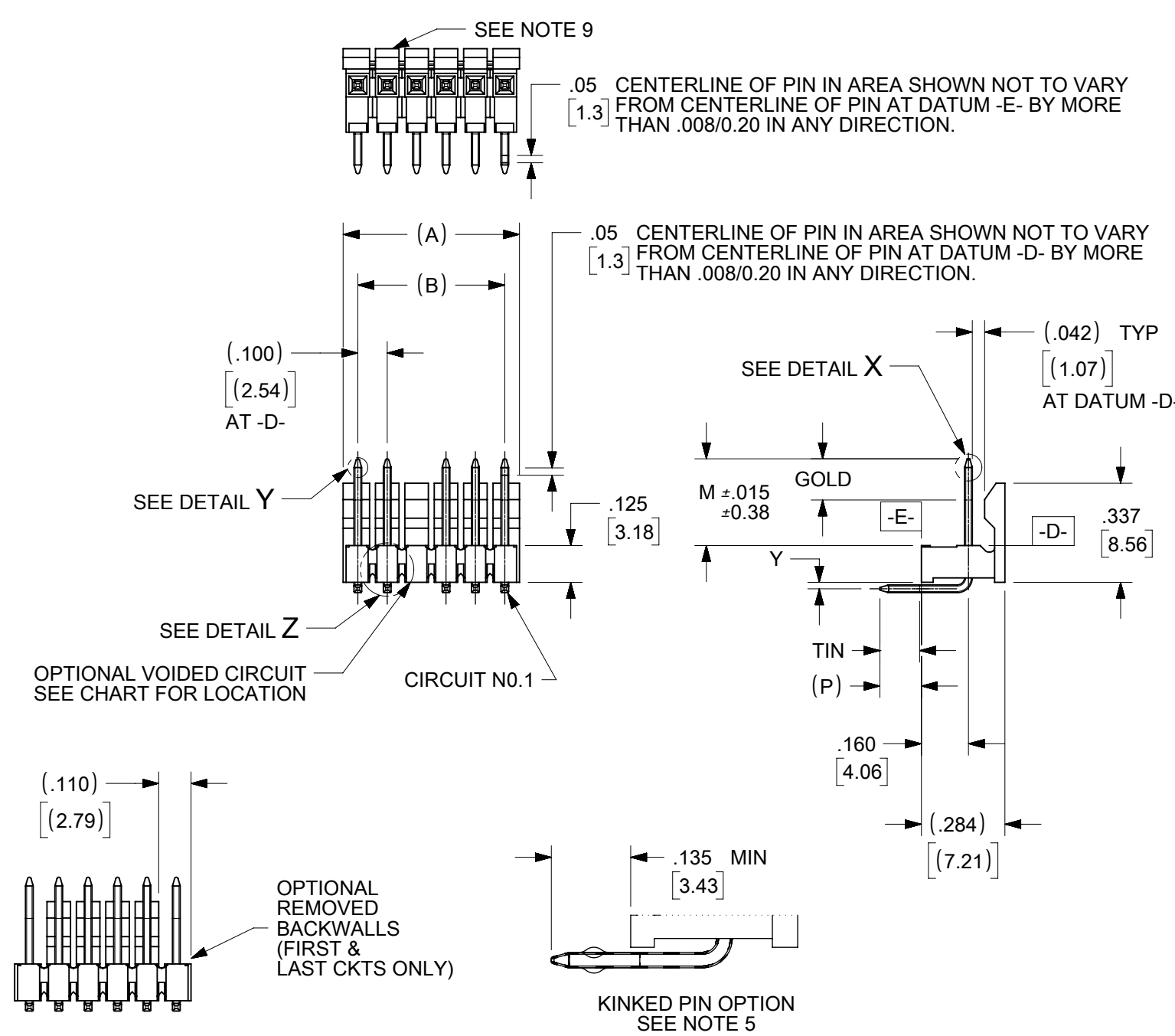
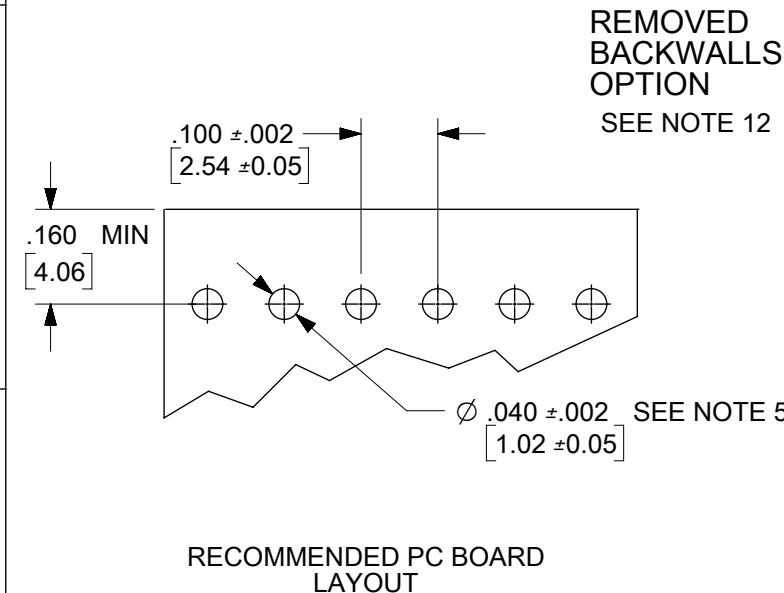
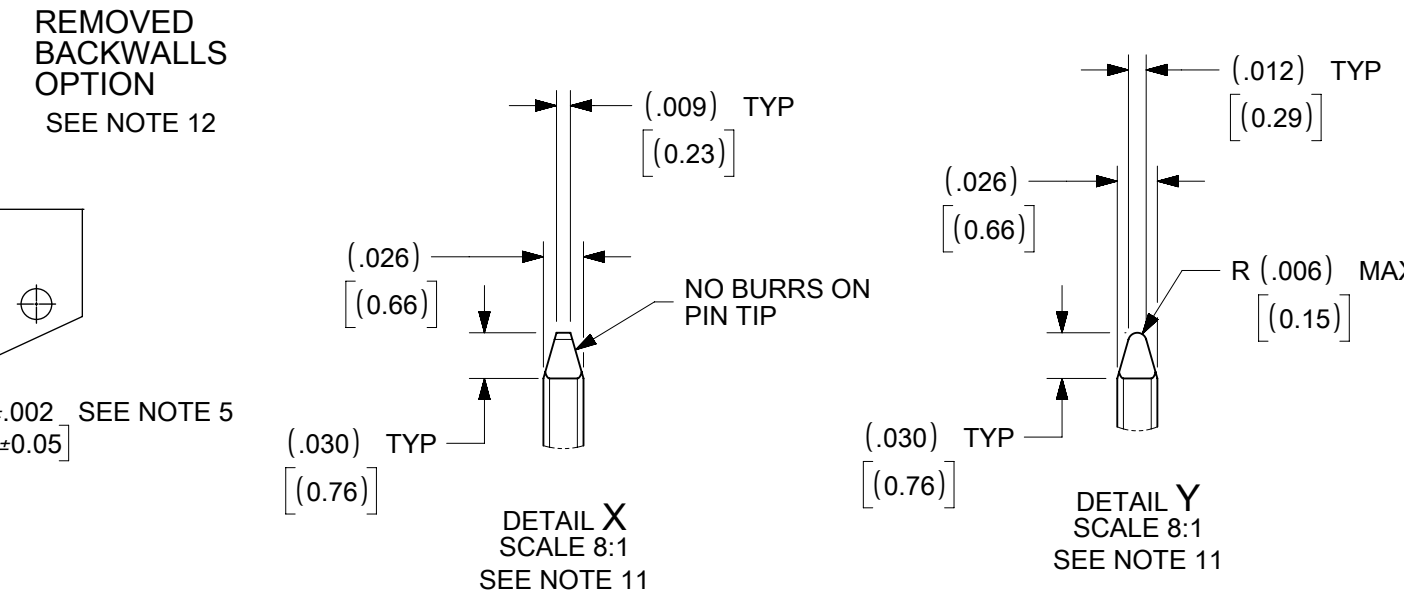

THIS DRAWING CONTAINS INFORMATION THAT IS PROPRIETARY TO MOLEX ELECTRONIC TECHNOLOGIES, LLC AND SHOULD NOT BE USED WITHOUT WRITTEN PERMISSION											
SYMBOLS		DIMENSION UNITS		SCALE		CURRENT REV DESC: NEW PIN ADDED					
▽ = 0	▽ = 0	in/mm		2:1		GENERAL TOLERANCES (UNLESS SPECIFIED)					
▽ = 0	▽ = 0			MM	INCH	4 PLACES ± .125 ± .01					
▽ = 0	▽ = 0					3 PLACES ± .125 ± .01					
▽ = 0	▽ = 0					2 PLACES ± .25 ± .01					
▽ = 0	▽ = 0					1 PLACE ± .36 ± .01					
▽ = 0	▽ = 0					0 PLACES ± .36 ± .01					
▽ = 0	▽ = 0					ANGULAR TOL ± 0.5°					
▽ = 0	▽ = 0					DRAFT WHERE APPLICABLE MUST REMAIN WITHIN DIMENSIONS		THIRD ANGLE PROJECTION		DRAWING	
▽ = 0	▽ = 0					B-SIZE		SERIES		MATERIAL NUMBER	
▽ = 0	▽ = 0					42228		42228		SEE CHART	
						CUSTOMER		GENERAL MARKET		SHEET NUMBER	
										1 OF 6	

DOCUMENT STATUS	P1	RELEASE DATE	2018/10/11	05:21:29
-----------------	----	--------------	------------	----------

A-42228-0213/0246					
HEADER NUMBER:		41411			
PIN NUMBER:		154			
PIN LENGTH: L		.705/17.91			
MATING LENGTH: M		.295/7.49			
GOLD POINT: G		N/A			
PC TAIL LENGTH: P		.120/3.05			
TIN: T		OVERALL			
DIMENSION Y		.022/0.56			
CKTS:		3-36			
KINKS:		NO			
REMOVED BACKWALLS:		YES			
VOIDED CKTS:		NONE			
PACKAGING:		BULK, PER PK-40873-0056			
CKTS	MATERIAL NUMBER	ENG NUMBER	CKTS	MATERIAL NUMBER	ENG NUMBER
2			20	22-28-1206	A-42228-0230
3	22-28-1036	A-42228-0213	21	22-28-1216	A-42228-0231
4	22-28-1046	A-42228-0214	22	22-28-1226	A-42228-0232
5	22-28-1056	A-42228-0215	23	22-28-1236	A-42228-0233
6	22-28-1066	A-42228-0216	24	22-28-1246	A-42228-0234
7	22-28-1076	A-42228-0217	25	22-28-1256	A-42228-0235
8	22-28-1086	A-42228-0218	26	22-28-1266	A-42228-0236
9	22-28-1096	A-42228-0219	27	22-28-1276	A-42228-0237
10	22-28-1106	A-42228-0220	28	22-28-1286	A-42228-0238
11	22-28-1116	A-42228-0221	29	22-28-1296	A-42228-0239
12	22-28-1126	A-42228-0222	30	22-28-1306	A-42228-0240
13	22-28-1136	A-42228-0223	31	22-28-1316	A-42228-0241
14	22-28-1146	A-42228-0224	32	22-28-1326	A-42228-0242
15	22-28-1156	A-42228-0225	33	22-28-1336	A-42228-0243
16	22-28-1166	A-42228-0226	34	22-28-1346	A-42228-0244
17	22-28-1176	A-42228-0227	35	22-28-1356	A-42228-0245
18	22-28-1186	A-42228-0228	36	22-28-1366	A-42228-0246
19	22-28-1196	A-42228-0229			

A-42228-0248/0281					
HEADER NUMBER:		41411			
PIN NUMBER:		208			
PIN LENGTH: L		.705/17.91			
MATING LENGTH: M		.295/7.49			
GOLD POINT: G		.140/3.56			
PC TAIL LENGTH: P		.120/3.05			
TIN: T		.135/3.43			
DIMENSION Y		.022/0.56			
CKTS:		3-36			
KINKS:		NO			
REMOVED BACKWALLS:		YES			
VOIDED CKTS:		NONE			
PACKAGING:		BULK, PER PK-40873-0056			
CKTS	MATERIAL NUMBER	ENG NUMBER	CKTS	MATERIAL NUMBER	ENG NUMBER
2			20	22-28-1207	A-42228-0265
3	22-28-1037	A-42228-0248	21	22-28-1217	A-42228-0266
4	22-28-1047	A-42228-0249	22	22-28-1227	A-42228-0267
5	22-28-1057	A-42228-0250	23	22-28-1237	A-42228-0268
6	22-28-1067	A-42228-0251	24	22-28-1247	A-42228-0269
7	22-28-1077	A-42228-0252	25	22-28-1257	A-42228-0270
8	22-28-1087	A-42228-0253	26	22-28-1267	A-42228-0271
9	22-28-1097	A-42228-0254	27	22-28-1277	A-42228-0272
10	22-28-1107	A-42228-0255	28	22-28-1287	A-42228-0273
11	22-28-1117	A-42228-0256	29	22-28-1297	A-42228-0274
12	22-28-1127	A-42228-0257	30	22-28-1307	A-42228-0275
13	22-28-1137	A-42228-0258	31	22-28-1317	A-42228-0276
14	22-28-1147	A-42228-0259	32	22-28-1327	A-42228-0277
15	22-28-1157	A-42228-0260	33	22-28-1337	A-42228-0278
16	22-28-1167	A-42228-0261	34	22-28-1347	A-42228-0279
17	22-28-1177	A-42228-0262	35	22-28-1357	A-42228-0280
18	22-28-1187	A-42228-0263	36	22-28-1367	A-42228-0281
19	22-28-1197	A-42228-0264			

<p>SYMBOLS</p> <p>THIS DRAWING CONTAINS INFORMATION THAT IS PROPRIETARY TO MOLEX ELECTRONIC TECHNOLOGIES, LLC AND SHOULD NOT BE USED WITHOUT WRITTEN PERMISSION</p> <p>CURRENT REV DESC: NEW PN ADDED</p>						<p><b>molex</b></p> <p>.100 FRICTION LOCK BREAKAWAY HEADER ASSY</p> <p>PRODUCT CUSTOMER DRAWING</p>																									
<p>GENERAL TOLERANCES (UNLESS SPECIFIED)</p> <table border="1"> <thead> <tr> <th></th> <th>MM</th> <th>INCH</th> </tr> </thead> <tbody> <tr> <td>4 PLACES</td> <td>±</td> <td>±</td> </tr> <tr> <td>3 PLACES</td> <td>±</td> <td>± 0.01</td> </tr> <tr> <td>2 PLACES</td> <td>± 0.25</td> <td>±</td> </tr> <tr> <td>1 PLACE</td> <td>± 0.36</td> <td>±</td> </tr> <tr> <td>0 PLACES</td> <td>±</td> <td>±</td> </tr> </tbody> </table>			MM	INCH	4 PLACES	±	±	3 PLACES	±	± 0.01	2 PLACES	± 0.25	±	1 PLACE	± 0.36	±	0 PLACES	±	±	<p>EC NO: 605734</p> <p>DRWN: SS06 2018/09/21</p> <p>CHK'D: ISHWARG 2018/10/11</p> <p>APPR: ISHWARG 2018/10/11</p>		<p>INITIAL REVISION:</p> <p>DRWN: JSCHAFFER 2004/03/18</p> <p>APPR: MARGULIS 2004/03/18</p>		<p>DOCUMENT NUMBER</p> <p><b>SD-42228-002</b></p>		<p>DOC TYPE</p> <p>PSD</p>		<p>DOC PART</p> <p>001</p>		<p>REVISION</p> <p>L7</p>	
	MM	INCH																													
4 PLACES	±	±																													
3 PLACES	±	± 0.01																													
2 PLACES	± 0.25	±																													
1 PLACE	± 0.36	±																													
0 PLACES	±	±																													
<p>DRAFT WHERE APPLICABLE MUST REMAIN WITHIN DIMENSIONS</p>		<p>THIRD ANGLE PROJECTION</p>		<p>DRAWING</p> <p>B-SIZE</p>		<p>SERIES</p> <p>42228</p>		<p>MATERIAL NUMBER</p> <p>SEE CHART</p>		<p>CUSTOMER</p> <p>GENERAL MARKET</p>		<p>SHEET NUMBER</p> <p>2 OF 6</p>																			
<p>DOCUMENT STATUS</p> <p>P1</p>		<p>RELEASE DATE</p> <p>2018/10/11 05:21:29</p>																													

A-42228-0283/0316					
F HEADER NUMBER:		41411			
PIN NUMBER:		228			
PIN LENGTH: L		.705/17.91			
MATING LENGTH: M		.295/7.49			
GOLD POINT: G		.140/3.56			
PC TAIL LENGTH: P		.120/3.05			
TIN: T		.135/3.43			
DIMENSION Y		.022/0.56			
E CKTS:		3-36			
KINKS:		NO			
REMOVED BACKWALLS:		YES			
VOIDED CKTS:		NONE			
PACKAGING:		BULK, PER PK-40873-0056			
CKTS	MATERIAL NUMBER	ENG NUMBER	CKTS	MATERIAL NUMBER	ENG NUMBER
2			20	22-28-1208	A-42228-0300
3	22-28-1038	A-42228-0283	21	22-28-1218	A-42228-0301
4	22-28-1048	A-42228-0284	22	22-28-1228	A-42228-0302
5	22-28-1058	A-42228-0285	23	22-28-1238	A-42228-0303
6	22-28-1068	A-42228-0286	24	22-28-1248	A-42228-0304
7	22-28-1078	A-42228-0287	25	22-28-1258	A-42228-0305
8	22-28-1088	A-42228-0288	26	22-28-1268	A-42228-0306
9	22-28-1098	A-42228-0289	27	22-28-1278	A-42228-0307
10	22-28-1108	A-42228-0290	28	22-28-1288	A-42228-0308
11	22-28-1118	A-42228-0291	29	22-28-1298	A-42228-0309
12	22-28-1128	A-42228-0292	30	22-28-1308	A-42228-0310
13	22-28-1138	A-42228-0293	31	22-28-1318	A-42228-0311
14	22-28-1148	A-42228-0294	32	22-28-1328	A-42228-0312
15	22-28-1158	A-42228-0295	33	22-28-1338	A-42228-0313
16	22-28-1168	A-42228-0296	34	22-28-1348	A-42228-0314
17	22-28-1178	A-42228-0297	35	22-28-1358	A-42228-0315
18	22-28-1188	A-42228-0298	36	22-28-1368	A-42228-0316
19	22-28-1198	A-42228-0299			

A-42228-0318/0351					
F HEADER NUMBER:		41411			
PIN NUMBER:		154			
PIN LENGTH: L		.720/18.29			
MATING LENGTH: M		.295/7.49			
GOLD POINT: G		N/A			
PC TAIL LENGTH: P		.135/3.43			
TIN: T		OVERALL			
DIMENSION Y		.022/0.56			
E CKTS:		3-36			
KINKS:		YES SMES-42003			
REMOVED BACKWALLS:		YES			
VOIDED CKTS:		NONE			
PACKAGING:		BULK, PER PK-40873-0056			
CKTS	MATERIAL NUMBER	ENG NUMBER	CKTS	MATERIAL NUMBER	ENG NUMBER
2			20	22-28-1209	A-42228-0335
3	22-28-1039	A-42228-0318	21	22-28-1219	A-42228-0336
4	22-28-1049	A-42228-0319	22	22-28-1229	A-42228-0337
5	22-28-1059	A-42228-0320	23	22-28-1239	A-42228-0338
6	22-28-1069	A-42228-0321	24	22-28-1249	A-42228-0339
7	22-28-1079	A-42228-0322	25	22-28-1259	A-42228-0340
8	22-28-1089	A-42228-0323	26	22-28-1269	A-42228-0341
9	22-28-1099	A-42228-0324	27	22-28-1279	A-42228-0342
10	22-28-1109	A-42228-0325	28	22-28-1289	A-42228-0343
11	22-28-1119	A-42228-0326	29	22-28-1299	A-42228-0344
12	22-28-1129	A-42228-0327	30	22-28-1309	A-42228-0345
13	22-28-1139	A-42228-0328	31	22-28-1319	A-42228-0346
14	22-28-1149	A-42228-0329	32	22-28-1329	A-42228-0347
15	22-28-1159	A-42228-0330	33	22-28-1339	A-42228-0348
16	22-28-1169	A-42228-0331	34	22-28-1349	A-42228-0349
17	22-28-1179	A-42228-0332	35	22-28-1359	A-42228-0350
18	22-28-1189	A-42228-0333	36	22-28-1369	A-42228-0351
19	22-28-1199	A-42228-0334			

B																																																																
A																																																																
<table border="1"> <tr> <td>DOCUMENT STATUS</td> <td>P1</td> <td>RELEASE DATE</td> <td>2018/10/11</td> <td>05:21:29</td> <td></td> </tr> </table>						DOCUMENT STATUS	P1	RELEASE DATE	2018/10/11	05:21:29																																																						
DOCUMENT STATUS	P1	RELEASE DATE	2018/10/11	05:21:29																																																												
<table border="1"> <tr> <td>SYMBOLS</td> <td colspan="5">THIS DRAWING CONTAINS INFORMATION THAT IS PROPRIETARY TO MOLEX ELECTRONIC TECHNOLOGIES, LLC AND SHOULD NOT BE USED WITHOUT WRITTEN PERMISSION</td> </tr> <tr> <td rowspan="2">  = 0   = 0   = 0   = 0   = 0   = 0   = 0   = 0   = 0 </td> <td colspan="2">           DIMENSION UNITS  <b>in/mm</b> </td> <td colspan="3">           SCALE  <b>1:1</b> </td> </tr> <tr> <td colspan="5">           GENERAL TOLERANCES (UNLESS SPECIFIED)           <table border="1"> <tr> <th></th> <th>MM</th> <th>INCH</th> </tr> <tr> <td>4 PLACES</td> <td>±</td> <td>±</td> </tr> <tr> <td>3 PLACES</td> <td>±</td> <td>± 0.01</td> </tr> <tr> <td>2 PLACES</td> <td>± 0.25</td> <td>±</td> </tr> <tr> <td>1 PLACE</td> <td>± 0.36</td> <td>±</td> </tr> <tr> <td>0 PLACES</td> <td>±</td> <td>±</td> </tr> </table> </td> </tr> <tr> <td colspan="2">           CURRENT REV DESC: NEW PN ADDED         </td> <td colspan="4">           EC NO: 605734            DRWN: SS06 2018/09/21            CHK'D: ISHWARG 2018/10/11            APPR: ISHWARG 2018/10/11         </td> </tr> <tr> <td colspan="2">           INITIAL REVISION:            DRWN: JSCHAFFER 2004/03/18            APPR: MARGULIS 2004/03/18         </td> <td colspan="4">           PRODUCT CUSTOMER DRAWING            DOCUMENT NUMBER: <b>SD-42228-002</b>            DOC TYPE: PSD            DOC PART: 001            REVISION: L7         </td> </tr> <tr> <td colspan="2">           DRAFT WHERE APPLICABLE MUST REMAIN WITHIN DIMENSIONS         </td> <td>           THIRD ANGLE PROJECTION  </td> <td>           DRAWING  <b>B-SIZE</b> </td> <td>           SERIES  <b>42228</b> </td> <td>           MATERIAL NUMBER            SEE CHART         </td> </tr> <tr> <td colspan="2"></td> <td colspan="2">           CUSTOMER            GENERAL MARKET         </td> <td colspan="2">           SHEET NUMBER            3 OF 6         </td> </tr> </table>						SYMBOLS	THIS DRAWING CONTAINS INFORMATION THAT IS PROPRIETARY TO MOLEX ELECTRONIC TECHNOLOGIES, LLC AND SHOULD NOT BE USED WITHOUT WRITTEN PERMISSION					= 0 = 0 = 0 = 0 = 0 = 0 = 0 = 0 = 0	DIMENSION UNITS <b>in/mm</b>		SCALE <b>1:1</b>			GENERAL TOLERANCES (UNLESS SPECIFIED) <table border="1"> <tr> <th></th> <th>MM</th> <th>INCH</th> </tr> <tr> <td>4 PLACES</td> <td>±</td> <td>±</td> </tr> <tr> <td>3 PLACES</td> <td>±</td> <td>± 0.01</td> </tr> <tr> <td>2 PLACES</td> <td>± 0.25</td> <td>±</td> </tr> <tr> <td>1 PLACE</td> <td>± 0.36</td> <td>±</td> </tr> <tr> <td>0 PLACES</td> <td>±</td> <td>±</td> </tr> </table>						MM	INCH	4 PLACES	±	±	3 PLACES	±	± 0.01	2 PLACES	± 0.25	±	1 PLACE	± 0.36	±	0 PLACES	±	±	CURRENT REV DESC: NEW PN ADDED		EC NO: 605734 DRWN: SS06 2018/09/21 CHK'D: ISHWARG 2018/10/11 APPR: ISHWARG 2018/10/11				INITIAL REVISION: DRWN: JSCHAFFER 2004/03/18 APPR: MARGULIS 2004/03/18		PRODUCT CUSTOMER DRAWING DOCUMENT NUMBER: <b>SD-42228-002</b> DOC TYPE: PSD DOC PART: 001 REVISION: L7				DRAFT WHERE APPLICABLE MUST REMAIN WITHIN DIMENSIONS		THIRD ANGLE PROJECTION 	DRAWING <b>B-SIZE</b>	SERIES <b>42228</b>	MATERIAL NUMBER SEE CHART			CUSTOMER GENERAL MARKET		SHEET NUMBER 3 OF 6	
SYMBOLS	THIS DRAWING CONTAINS INFORMATION THAT IS PROPRIETARY TO MOLEX ELECTRONIC TECHNOLOGIES, LLC AND SHOULD NOT BE USED WITHOUT WRITTEN PERMISSION																																																															
= 0 = 0 = 0 = 0 = 0 = 0 = 0 = 0 = 0	DIMENSION UNITS <b>in/mm</b>		SCALE <b>1:1</b>																																																													
	GENERAL TOLERANCES (UNLESS SPECIFIED) <table border="1"> <tr> <th></th> <th>MM</th> <th>INCH</th> </tr> <tr> <td>4 PLACES</td> <td>±</td> <td>±</td> </tr> <tr> <td>3 PLACES</td> <td>±</td> <td>± 0.01</td> </tr> <tr> <td>2 PLACES</td> <td>± 0.25</td> <td>±</td> </tr> <tr> <td>1 PLACE</td> <td>± 0.36</td> <td>±</td> </tr> <tr> <td>0 PLACES</td> <td>±</td> <td>±</td> </tr> </table>						MM	INCH	4 PLACES	±	±	3 PLACES	±	± 0.01	2 PLACES	± 0.25	±	1 PLACE	± 0.36	±	0 PLACES	±	±																																									
	MM	INCH																																																														
4 PLACES	±	±																																																														
3 PLACES	±	± 0.01																																																														
2 PLACES	± 0.25	±																																																														
1 PLACE	± 0.36	±																																																														
0 PLACES	±	±																																																														
CURRENT REV DESC: NEW PN ADDED		EC NO: 605734 DRWN: SS06 2018/09/21 CHK'D: ISHWARG 2018/10/11 APPR: ISHWARG 2018/10/11																																																														
INITIAL REVISION: DRWN: JSCHAFFER 2004/03/18 APPR: MARGULIS 2004/03/18		PRODUCT CUSTOMER DRAWING DOCUMENT NUMBER: <b>SD-42228-002</b> DOC TYPE: PSD DOC PART: 001 REVISION: L7																																																														
DRAFT WHERE APPLICABLE MUST REMAIN WITHIN DIMENSIONS		THIRD ANGLE PROJECTION 	DRAWING <b>B-SIZE</b>	SERIES <b>42228</b>	MATERIAL NUMBER SEE CHART																																																											
		CUSTOMER GENERAL MARKET		SHEET NUMBER 3 OF 6																																																												

A-42228-0422/0454					
F HEADER NUMBER:		41411			
PIN NUMBER:		228			
PIN LENGTH: L		.705/17.91			
MATING LENGTH: M		.295/7.49			
GOLD POINT: G		.140/3.56			
PC TAIL LENGTH: P		.120/3.05			
TIN: T		.135/3.43			
DIMENSION Y		.022/0.56			
E CKTS:		3-36			
KINKS:		NO			
REMOVED BACKWALLS:		YES			
VOIDED CKTS:		3			
PACKAGING:		BULK, PER PK-40873-0056			
CKTS	MATERIAL NUMBER	ENG NUMBER	CKTS	MATERIAL NUMBER	ENG NUMBER
2			20		A-42228-0439
3		A-42228-0422	21		A-42228-0440
4	22-29-1041	A-42228-0423	22		A-42228-0441
5		A-42228-0424	23		A-42228-0442
6		A-42228-0425	24		A-42228-0443
7		A-42228-0426	25		A-42228-0444
8		A-42228-0427	26		A-42228-0445
9		A-42228-0428	27		A-42228-0446
10		A-42228-0429	28		A-42228-0447
11		A-42228-0430	29		A-42228-0448
12		A-42228-0431	30		A-42228-0449
13		A-42228-0432	31		A-42228-0450
14		A-42228-0433	32		A-42228-0451
15		A-42228-0434	33		A-42228-0452
16		A-42228-0435	34		A-42228-0453
17		A-42228-0436	35		A-42228-0454
18		A-42228-0437	36		A-42228-0455
19		A-42228-0438			

A-42228-0456/0490					
F HEADER NUMBER:		41411			
PIN NUMBER:		208			
PIN LENGTH: L		.720/18.29			
MATING LENGTH: M		.295/7.49			
GOLD POINT: G		.140/3.56			
PC TAIL LENGTH: P		.135/3.43			
TIN: T		.135/3.43			
DIMENSION Y		.022/0.56			
E CKTS:		2-36			
KINKS:		YES SMES-42003			
REMOVED BACKWALLS:		NO			
VOIDED CKTS:		2			
PACKAGING:		BULK, PER PK-40873-0056			
CKTS	MATERIAL NUMBER	ENG NUMBER	CKTS	MATERIAL NUMBER	ENG NUMBER
2		A-42228-0456	20	22-29-1204	A-42228-0474
3	22-29-1034	A-42228-0457	21	22-29-1214	A-42228-0475
4	22-29-1044	A-42228-0458	22	22-29-1224	A-42228-0476
5	22-29-1054	A-42228-0459	23	22-29-1234	A-42228-0477
6	22-29-1064	A-42228-0460	24	22-29-1244	A-42228-0478
7	22-29-1074	A-42228-0461	25	22-29-1254	A-42228-0479
8	22-29-1084	A-42228-0462	26	22-29-1264	A-42228-0480
9	22-29-1094	A-42228-0463	27	22-29-1274	A-42228-0481
10	22-29-1104	A-42228-0464	28	22-29-1284	A-42228-0482
11	22-29-1114	A-42228-0465	29	22-29-1294	A-42228-0483
12	22-29-1124	A-42228-0466	30	22-29-1304	A-42228-0484
13	22-29-1134	A-42228-0467	31	22-29-1314	A-42228-0485
14	22-29-1144	A-42228-0468	32	22-29-1324	A-42228-0486
15	22-29-1154	A-42228-0469	33	22-29-1334	A-42228-0487
16	22-29-1164	A-42228-0470	34	22-29-1344	A-42228-0488
17	22-29-1174	A-42228-0471	35	22-29-1354	A-42228-0489
18	22-29-1184	A-42228-0472	36	22-29-1364	A-42228-0490
19	22-29-1194	A-42228-0473			

A					
DOCUMENT STATUS		P1	RELEASE DATE	2018/10/11	05:21:29

SYMBOLS						THIS DRAWING CONTAINS INFORMATION THAT IS PROPRIETARY TO MOLEX ELECTRONIC TECHNOLOGIES, LLC AND SHOULD NOT BE USED WITHOUT WRITTEN PERMISSION					
DIMENSION UNITS		SCALE		CURRENT REV DESC: NEW PN ADDED							
in/mm		1:1		 .100 FRICTION LOCK BREAKAWAY HEADER ASSY PRODUCT CUSTOMER DRAWING							
GENERAL TOLERANCES (UNLESS SPECIFIED)											
4 PLACES ±		MM		INCH		EC NO: 605734		2018/09/21			
3 PLACES ±		0.25		0.01		DRWN: SS06		2018/10/11			
2 PLACES ±		0.36		0.01		CHK'D: ISHWARG		2018/10/11			
1 PLACE ±		0.5		0.01		APPR: ISHWARG		2018/10/11			
0 PLACES ±		0.5		0.01		INITIAL REVISION:		DOCUMENT NUMBER			
ANGULAR TOL ± 0.5°		THIRD ANGLE PROJECTION		DRAWING		SERIES		MATERIAL NUMBER			
DRAFT WHERE APPLICABLE MUST REMAIN WITHIN DIMENSIONS		B-SIZE		42228		SEE CHART		CUSTOMER			
								REVISION			
								SD-42228-002			
								PSD 001 L7			
								SHEET NUMBER			
								4 OF 6			

A-42228-0491/0524					
HEADER NUMBER:		41411			
PIN NUMBER:		154			
PIN LENGTH: L		.720/18.29			
MATING LENGTH: M		.295/7.49			
GOLD POINT: G		N/A			
PC TAIL LENGTH: P		.135/3.43			
TIN: T		OVERALL			
DIMENSION Y		.022/0.56			
CKTS:		3-36			
KINKS:		YES SMES-43703-0000			
REMOVED BACKWALLS:		YES			
VOIDED CKTS:		NONE			
PACKAGING:		BULK, PER PK-40873-0056			
CKTS	MATERIAL NUMBER	ENG NUMBER	CKTS	MATERIAL NUMBER	ENG NUMBER
2			20		A-42228-0508
3		A-42228-0491	21		A-42228-0509
4	42228-0492	A-42228-0492	22		A-42228-0510
5	42228-0493	A-42228-0493	23		A-42228-0511
6	42228-0494	A-42228-0494	24		A-42228-0512
7	42228-0495	A-42228-0495	25		A-42228-0513
8		A-42228-0496	26		A-42228-0514
9		A-42228-0497	27		A-42228-0515
10		A-42228-0498	28		A-42228-0516
11	42228-0499	A-42228-0499	29		A-42228-0517
12		A-42228-0500	30		A-42228-0518
13		A-42228-0501	31		A-42228-0519
14		A-42228-0502	32		A-42228-0520
15		A-42228-0503	33		A-42228-0521
16		A-42228-0504	34		A-42228-0522
17		A-42228-0505	35		A-42228-0523
18		A-42228-0506	36		A-42228-0524
19		A-42228-0507			

A-42228-0525/0537					
HEADER NUMBER:		41411			
PIN NUMBER:		154			
PIN LENGTH: L		.720/18.29			
MATING LENGTH: M		.295/7.49			
GOLD POINT: G		N/A			
PC TAIL LENGTH: P		.135/3.43			
TIN: T		OVERALL			
DIMENSION Y		.022/0.56			
CKTS:		24-36			
KINKS:		YES SMES-42003			
REMOVED BACKWALLS:		NO			
VOIDED CKTS:		5,7,11,13,16,20,24			
PACKAGING:		BULK, PER PK-40873-0056			
CKTS	MATERIAL NUMBER	ENG NUMBER	CKTS	MATERIAL NUMBER	ENG NUMBER
2			20		
3			21		
4			22		
5			23		
6			24	42228-0525	A-42228-0525
7			25	42228-0526	A-42228-0526
8			26	42228-0527	A-42228-0527
9			27	42228-0528	A-42228-0528
10			28	42228-0529	A-42228-0529
11			29	42228-0530	A-42228-0530
12			30	42228-0531	A-42228-0531
13			31	42228-0532	A-42228-0532
14			32	42228-0533	A-42228-0533
15			33	42228-0534	A-42228-0534
16			34	42228-0535	A-42228-0535
17			35	42228-0536	A-42228-0536
18			36	42228-0537	A-42228-0537
19					

<p>SYMBOLS</p> <p>THIS DRAWING CONTAINS INFORMATION THAT IS PROPRIETARY TO MOLEX ELECTRONIC TECHNOLOGIES, LLC AND SHOULD NOT BE USED WITHOUT WRITTEN PERMISSION</p> <p>CURRENT REV DESC: NEW PIN ADDED</p> <p>EC NO: 605734</p> <p>DRWN: SS06 2018/09/21</p> <p>CHK'D: ISHWARG 2018/10/11</p> <p>APPR: ISHWARG 2018/10/11</p> <p>INITIAL REVISION:</p> <p>DRWN: JSCHAFFER 2004/03/18</p> <p>APPR: MARGULIS 2004/03/18</p> <p>DRAFT WHERE APPLICABLE MUST REMAIN WITHIN DIMENSIONS</p> <p>THIRD ANGLE PROJECTION</p> <p>DRAWING SERIES</p> <p>B-SIZE 42228</p> <p>MATERIAL NUMBER CUSTOMER SHEET NUMBER</p> <p>SEE CHART GENERAL MARKET 5 OF 6</p>						<p>DOCUMENT STATUS P1 RELEASE DATE 2018/10/11 05:21:29</p>																										
<p>THIS DRAWING CONTAINS INFORMATION THAT IS PROPRIETARY TO MOLEX ELECTRONIC TECHNOLOGIES, LLC AND SHOULD NOT BE USED WITHOUT WRITTEN PERMISSION</p> <p>DIMENSION UNITS SCALE</p> <p>in/mm 1:1</p> <p>GENERAL TOLERANCES (UNLESS SPECIFIED)</p> <table border="1"> <thead> <tr> <th></th> <th>MM</th> <th>INCH</th> </tr> </thead> <tbody> <tr> <td>4 PLACES ±</td> <td></td> <td></td> </tr> <tr> <td>3 PLACES ±</td> <td></td> <td>± 0.01</td> </tr> <tr> <td>2 PLACES ±</td> <td>0.25</td> <td></td> </tr> <tr> <td>1 PLACE ±</td> <td>0.36</td> <td></td> </tr> <tr> <td>0 PLACES ±</td> <td></td> <td></td> </tr> <tr> <td>ANGULAR TOL ±</td> <td colspan="2">0.5°</td> </tr> </tbody> </table> <p>PRODUCT CUSTOMER DRAWING</p> <p>DOCUMENT NUMBER SD-42228-002 DOC TYPE PSD DOC PART 001 REVISION L7</p>							MM	INCH	4 PLACES ±			3 PLACES ±		± 0.01	2 PLACES ±	0.25		1 PLACE ±	0.36		0 PLACES ±			ANGULAR TOL ±	0.5°		<p><b>molex</b></p> <p>.100 FRICTION LOCK BREAKAWAY HEADER ASSY</p>					
	MM	INCH																														
4 PLACES ±																																
3 PLACES ±		± 0.01																														
2 PLACES ±	0.25																															
1 PLACE ±	0.36																															
0 PLACES ±																																
ANGULAR TOL ±	0.5°																															

A-42228-0538/0566					
F HEADER NUMBER:			41411		
PIN NUMBER:			154		
PIN LENGTH: L			.720/18.29		
MATING LENGTH: M			.295/7.49		
GOLD POINT: G			N/A		
PC TAIL LENGTH: P			.135/3.43		
TIN: T			OVERALL		
E DIMENSION Y			.022/0.56		
CKTS:			8-36		
KINKS:			YES SMES-42003		
REMOVED BACKWALLS:			NO		
VOIDED CKTS:			8		
PACKAGING:			BULK, PER PK-40873-0056		
CKTS	MATERIAL NUMBER	ENG NUMBER	CKTS	MATERIAL NUMBER	ENG NUMBER
2			20	42228-0550	A-42228-0550
3			21	42228-0551	A-42228-0551
4			22	42228-0552	A-42228-0552
5			23	42228-0553	A-42228-0553
6			24	42228-0554	A-42228-0554
7			25	42228-0555	A-42228-0555
8	42228-0538	A-42228-0538	26	42228-0556	A-42228-0556
9	42228-0539	A-42228-0539	27	42228-0557	A-42228-0557
10	42228-0540	A-42228-0540	28	42228-0558	A-42228-0558
11	42228-0541	A-42228-0541	29	42228-0559	A-42228-0559
12	42228-0542	A-42228-0542	30	42228-0560	A-42228-0560
13	42228-0543	A-42228-0543	31	42228-0561	A-42228-0561
14	42228-0544	A-42228-0544	32	42228-0562	A-42228-0562
15	42228-0545	A-42228-0545	33	42228-0563	A-42228-0563
16	42228-0546	A-42228-0546	34	42228-0564	A-42228-0564
17	42228-0547	A-42228-0547	35	42228-0565	A-42228-0565
18	42228-0548	A-42228-0548	36	42228-0566	A-42228-0566
19	42228-0549	A-42228-0549			

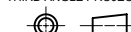
SYMBOLS						THIS DRAWING CONTAINS INFORMATION THAT IS PROPRIETARY TO MOLEX ELECTRONIC TECHNOLOGIES, LLC AND SHOULD NOT BE USED WITHOUT WRITTEN PERMISSION											
= 0		in/mm		SCALE 1:1		CURRENT REV DESC: NEW PN ADDED											
= 0		GENERAL TOLERANCES (UNLESS SPECIFIED)				EC NO: 605734											
= 0		MM		INCH		DRWN: SS06		2018/09/21		 .100 FRICTION LOCK BREAKAWAY HEADER ASSY PRODUCT CUSTOMER DRAWING							
= 0		4 PLACES ±		±		CHK'D: ISHWARG		2018/10/11									
= 0		3 PLACES ±		± 0.01		APPR: ISHWARG		2018/10/11									
= 0		2 PLACES ±		± 0.25 ±		INITIAL REVISION:											
= 0		1 PLACE ±		± 0.36 ±		DRWN: JSCHAFFER		2004/03/18		DOCUMENT NUMBER		DOC TYPE		DOC PART		REVISION	
= 0		0 PLACES ±		±		APPR: MARGULIS		2004/03/18		SD-42228-002		PSD		001		L7	
= 0		ANGULAR TOL ± 0.5 °				THIRD ANGLE PROJECTION		DRAWING		SERIES		MATERIAL NUMBER		CUSTOMER		SHEET NUMBER	
= 0		DRAFT WHERE APPLICABLE MUST REMAIN WITHIN DIMENSIONS						B-SIZE		42228		SEE CHART		GENERAL MARKET		6 OF 6	

DOCUMENT STATUS	P1	RELEASE DATE	2018/10/11	05:21:29
-----------------	----	--------------	------------	----------