

521204-1 ✓ ACTIVE

RAST | RAST 5 IDC Connectors

TE Internal #: 521204-1

Housing, Receptacle, Cable-to-Board, 2 Position, .197 in [5 mm]
Centerline, Crimp, 1 Row, Blue, Mating Retention, Wire & Cable,
RAST 5 IDC Connectors

[View on TE.com >](#)



Connectors > PCB Connectors > Wire-to-Board Connectors > Wire-to-Board Connector Assemblies & Housings

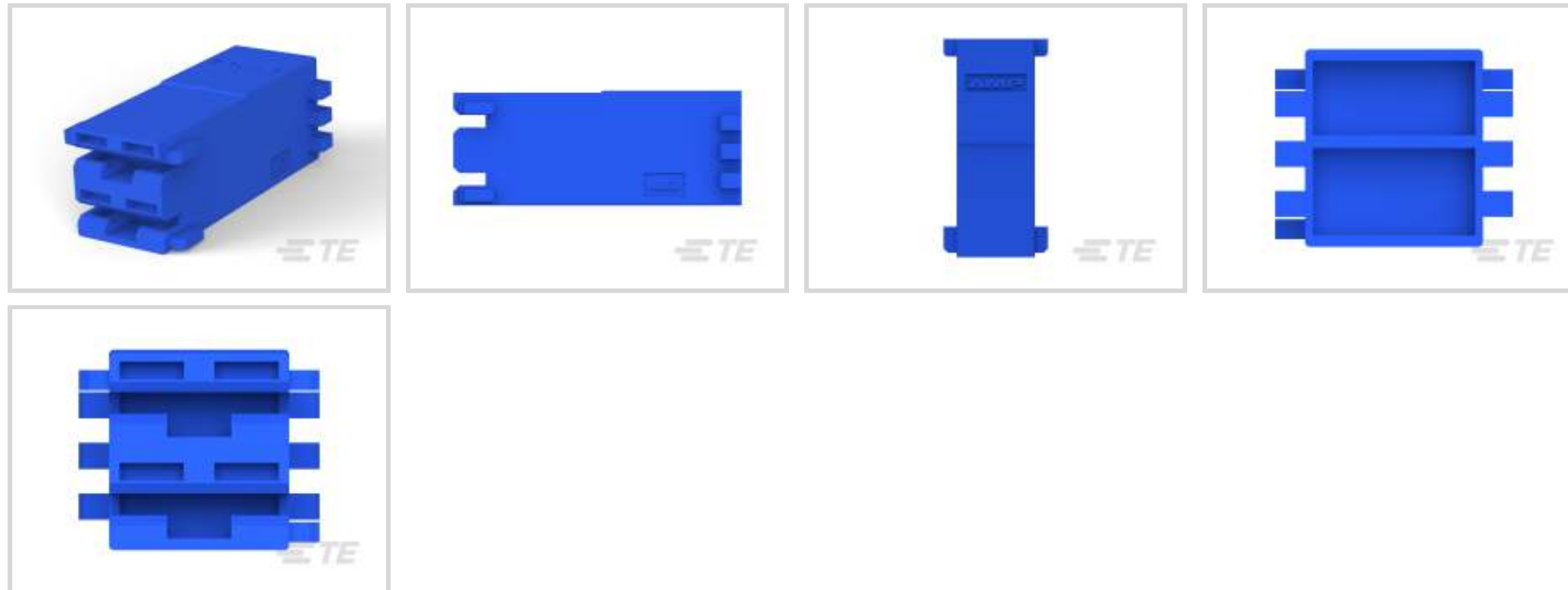

Connector Product Type: **Housing**

Connector & Housing Type: **Receptacle**

Connector System: **Cable-to-Board**

Number of Positions: **2**

Centerline (Pitch): **5 mm [.197 in]**

Features

Product Type Features

Connector Product Type	Housing
Connector & Housing Type	Receptacle
Connector System	Cable-to-Board
Sealable	No
Connector & Contact Terminates To	Wire & Cable

Configuration Features

Keying & Polarized Position Locations	2D
Number of Positions	2
Number of Rows	1

Body Features

Primary Product Color	Blue
-----------------------	------

Contact Features

Contact Type	Socket
--------------	--------



Termination Features

Termination Method to Wire & Cable	Crimp
------------------------------------	-------

Mechanical Attachment

Strain Relief	Without
Panel Mount Feature	Without
PCB Mount Retention	Without
Mating Retention Type	Latch
Mating Retention	With
Connector Mounting Type	Cable Mount (Free-Hanging)

Housing Features

Housing Entry Configuration	Both Ends Closed
Housing Material	Nylon 66/6
Centerline (Pitch)	5 mm [.197 in]

Dimensions

Connector Length	9.2 mm [.362 in]
Connector Height	12.2 mm [.48 in]
Row-to-Row Spacing	5 mm [.197 in]

Usage Conditions

Operating Temperature Range	-55 – 105 °C [-67 – 221 °F]
-----------------------------	-----------------------------

Operation/Application

Circuit Application	Power
---------------------	-------

Industry Standards

Glow Wire Rating	Standard Part - Not Glow Wire
UL Flammability Rating	UL 94V-0

Packaging Features

Packaging Quantity	1
Packaging Method	Package

Product Compliance

For compliance documentation, visit the product page on [TE.com](https://www.te.com)>

EU RoHS Directive 2011/65/EU	Compliant
EU ELV Directive 2000/53/EC	Compliant



China RoHS 2 Directive MIIT Order No 32, 2016	No Restricted Materials Above Threshold
EU REACH Regulation (EC) No. 1907/2006	Current ECHA Candidate List: JUNE 2023 (235) Candidate List Declared Against: JAN 2023 (233) Does not contain REACH SVHC
Halogen Content	Low Halogen - Br, Cl, F, I < 900 ppm per homogenous material. Also BFR/CFR/PVC Free
Solder Process Capability	Not applicable for solder process capability

Product Compliance Disclaimer

This information is provided based on reasonable inquiry of our suppliers and represents our current actual knowledge based on the information they provided. This information is subject to change. The part numbers that TE has identified as EU RoHS compliant have a maximum concentration of 0.1% by weight in homogenous materials for lead, hexavalent chromium, mercury, PBB, PBDE, DBP, BBP, DEHP, DIBP, and 0.01% for cadmium, or qualify for an exemption to these limits as defined in the Annexes of Directive 2011/65/EU (RoHS2). Finished electrical and electronic equipment products will be CE marked as required by Directive 2011/65/EU. Components may not be CE marked. Additionally, the part numbers that TE has identified as EU ELV compliant have a maximum concentration of 0.1% by weight in homogenous materials for lead, hexavalent chromium, and mercury, and 0.01% for cadmium, or qualify for an exemption to these limits as defined in the Annexes of Directive 2000/53/EC (ELV). Regarding the REACH Regulation, the information TE provides on SVHC in articles for this part number is based on the latest European Chemicals Agency (ECHA) 'Guidance on requirements for substances in articles' posted at this URL: <https://echa.europa.eu/guidance-documents/guidance-on-reach>







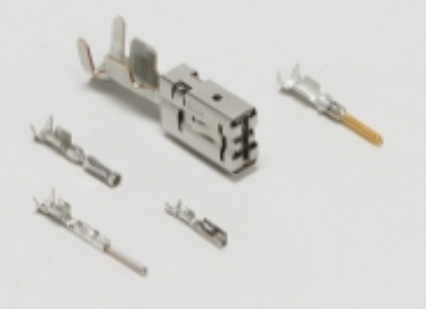

Compatible Parts

 <p>TE Part # 521206-1 POSI-LOK HSG.250-4 POS RAST5</p>	 <p>TE Part # 521204-6 RAST 5,HSG,2P,POSILOCK MKIII</p>	 <p>TE Part # 521295-1 HOUSING, POSITIVE LOCK, RAST</p>	 <p>TE Part # 521204-5 HSG,POS LOC,MARKIII,250 SRS,2P</p>
 <p>TE Part # 521204-2 HSG RCPT POSI MK 111 250 2POS</p>	 <p>TE Part # 1-521204-1 RAST 5,HSG,2P,GWT POSILOCK MKI</p>	 <p>TE Part # 1969371-2 HSG, RAST 5 POSITIVE LOCK, 4P 2C</p>	 <p>TE Part # 521204-3 HSG,2P,POS LOCK,MKIII,250 SERI</p>

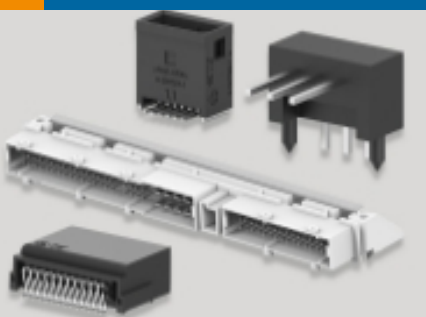

 <p>TE Part # 521204-7 RAST 5,HSG,2P,POSILOCK MKIII</p>	 <p>TE Part # 521204-8 RAST 5,HSG,2P,POSILOCK MKIII</p>	 <p>TE Part # 521206-6 POSI-LOK HSG.250-4 POS RAST5</p>	 <p>TE Part # 521295-2 HSG,P LOCK,MKIII,250 SER,4P/3C</p>
 <p>TE Part # 521435-1 HSG,POS-LOK,MARK3.250SRS,6P/4C</p>	 <p>TE Part # 1-521204-0 POSI-LOK HSG 250 RAST5 spec</p>	 <p>TE Part # 1969404-2 HSG,RAST 5 PL,10P,B2,5,6,7,8 W</p>	 <p>TE Part # 1969429-2 HOUSING, POSITIVE-LOCK MK III, RAST5, 2P</p>
 <p>TE Part # 1969429-3 HOUSING, POSITIVE-LOCK MK III, RAST5, 2P</p>	 <p>TE Part # 1969429-4 HOUSING, POSITIVE-LOCK MK III, RAST5, 2P</p>	 <p>TE Part # 1969433-1 HSG,RAST 5 PL-MKIII,5POS,B2,3</p>	 <p>TE Part # 521204-4 HSG,2P,POS LOCK,MKIII,250 SERI</p>

Also in the Series | RAST 5 IDC Connectors

 <p>Automotive Terminals(8)</p>	 <p>Connector Contacts(12)</p>	 <p>Crimp Terminal Housings(41)</p>	 <p>Insertion & Extraction Tools(1)</p>
 <p>PCB Headers & Receptacles(417)</p>	 <p>Rectangular Connector Housings(1)</p>	 <p>Standard Edge Connectors(34)</p>	 <p>Standard Rectangular Connectors(68)</p>

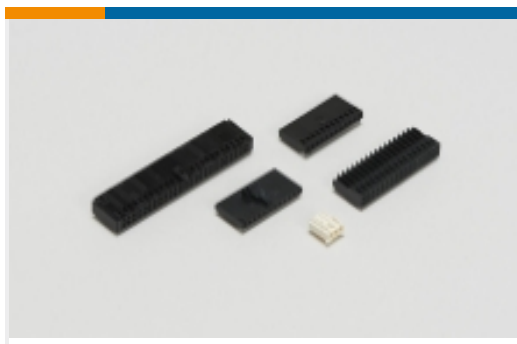

Wire-to-Board Connector Assemblies & Housings(214)



Wire-to-Board Connector Contacts(2)

Customers Also Bought

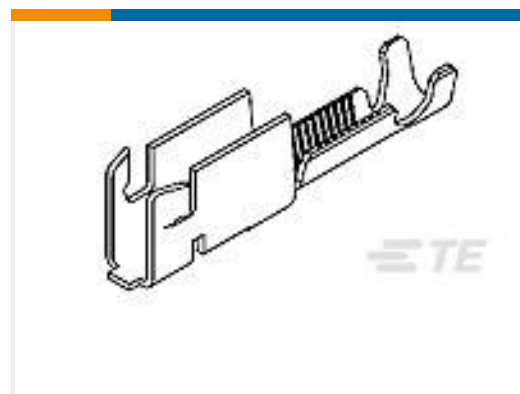
TE Part #521205-1
POSI-LOK HSG.250-3 POS RAST5TE Part #1217378-2
RCPT 250POS-LOC 22-18 0126TPBRTE Part #1217095-1
RCPT 250 POS-LOCK 16-12 0126BRTE Part #928810-1
TIMER, RECEPTACLE AND TABTE Part #4-1718353-2
2 POS TAB HSG 5.8x0.8MMTE Part #1742657-1
CLUSTER BLOCK RECP 22-18 020TPTE Part #062600-000
VERSAFIT-1/4-0-16MMTE Part #520194K050
RT-3-NO.3-0-0.5IN

Documents

Product Drawings

[POSI-LOK HSG.250-2 POS RAST5](#)

English

CAD Files

[3D PDF](#)

3D

Customer View Model

[ENG_CVM_CVM_521204-1_AB.2d_dxf.zip](#)

English

Customer View Model

[ENG_CVM_CVM_521204-1_AB.3d_igs.zip](#)

English

Customer View Model

[ENG_CVM_CVM_521204-1_AB.3d_stp.zip](#)

English

By downloading the CAD file I accept and agree to the [Terms and Conditions](#) of use.



Datasheets & Catalog Pages

[1654742_HOUSEHOLD_APPLIANCES_RAST5](#)

English

Product Specifications

[Application Specification](#)

English

Product Environmental Compliance

[TE Material Declaration](#)

English

Agency Approvals

[UL Report](#)

English