

TRENCHSTOP™ IGBT6 with soft, fast recovery antiparallel Rapid diode

Features

- $V_{CE} = 650\text{ V}$
- $I_C = 10\text{ A}$
- Very low $V_{CE(sat)}$ 1.5 V (typ.)
- Maximum junction temperature $T_{vjmax} = 175^\circ\text{C}$
- Short circuit withstand time 3 μs
- Very tight parameter distribution
- High ruggedness, temperature stable behavior
- Low $V_{CE(sat)}$ and positive temperature coefficient
- Low gate charge Q_G
- Pb-free lead plating; RoHS compliant
- Very soft, fast recovery antiparallel Rapid diode
- Product spectrum and PSpice Models: <http://www.infineon.com/igbt/>

Potential applications

- General purpose drives (GPD)
- Air conditioning
- Other major home appliances
- Other small home appliances

Product validation

- Qualified for industrial applications according to the relevant tests of JEDEC47/20/22

Description



- Lead-Free
- Green
- Halogen-Free
- RoHS

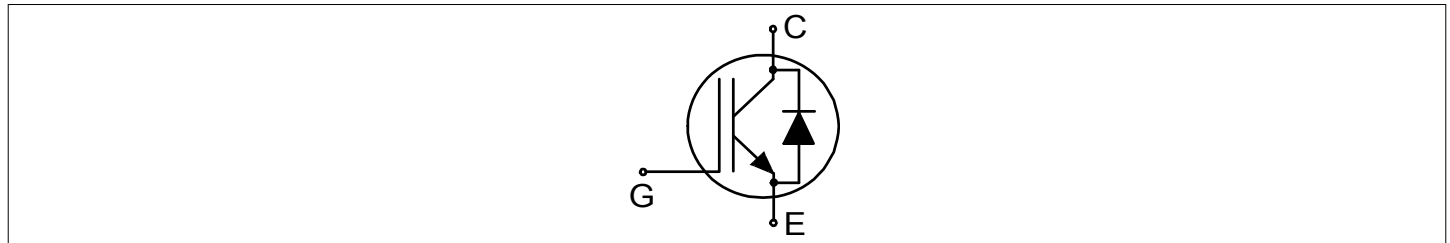

Type	Package	Marking
IKA10N65ET6	PG-TO220-3 FP	K10EET6

Table of contents

	Description	1
	Features	1
	Potential applications	1
	Product validation	1
	Table of contents	2
1	Package	3
2	IGBT	3
3	Diode	5
4	Characteristics diagrams	7
5	Package outlines	14
6	Testing conditions	15
	Revision history	16
	Disclaimer	17

1 Package

Table 1 Characteristic values

Parameter	Symbol	Note or test condition	Values			Unit
			Min.	Typ.	Max.	
Isolation test voltage RMS	V_{isol}	$f = +50/+60$ Hz, $t = 1$ min			2500	V
Internal emitter inductance measured 5 mm (0.197 in) from case	L_E			7.0		nH
Storage temperature	T_{stg}		-55		150	°C
Soldering temperature		wave soldering 1.6mm (0.063in.) from case for 10s			260	°C
Mounting torque, M3 screw Maximum of mounting processes: 3	M				0.5	Nm
Thermal resistance, junction-ambient	$R_{th(j-a)}$				65	K/W

2 IGBT

Table 2 Maximum rated values

Parameter	Symbol	Note or test condition	Values	Unit
Collector-emitter voltage	V_{CE}	$T_{vj} \geq 25$ °C	650	V
DC collector current, limited by T_{vjmax} ¹⁾	I_C	$T_h = 25$ °C	25	A
		$T_h = 100$ °C	16	
Pulsed collector current, t_p limited by T_{vjmax}	I_{Cpuls}		42.5	A
Turn-off safe operating area		$V_{CE} \leq 650$ V, $T_{vj} \leq 175$ °C	42.5	A
Gate-emitter voltage	V_{GE}		±20	V
Transient gate-emitter voltage	V_{GE}	$t_p \leq 10$ μs, $D < 0.010$	±30	V
Short-circuit withstand time	t_{SC}	$V_{CC} \leq 360$ V, $V_{GE} = 15$ V, Allowed number of short circuits < 1000, Time between short circuits ≥ 1.0 s, $T_{vj} = 150$ °C	3	μs
Power dissipation	P_{tot}	$T_h = 25$ °C	32.5	W
		$T_h = 100$ °C	16.2	

1) Limited by maximum junction temperature. Applicable for TO220 standard package.

Table 3 Characteristic values

Parameter	Symbol	Note or test condition	Values			Unit
			Min.	Typ.	Max.	
Collector-emitter breakdown voltage ¹⁾	V_{BRCES}	$I_C = 0.1 \text{ mA}, V_{GE} = 0 \text{ V}$	650			V
Collector-emitter saturation voltage	V_{CEsat}	$I_C = 8.5 \text{ A}, V_{GE} = 15 \text{ V}$	$T_{vj} = 25 \text{ °C}$	1.5	1.9	V
			$T_{vj} = 125 \text{ °C}$	1.65		
			$T_{vj} = 150 \text{ °C}$	1.75		
Gate-emitter threshold voltage	V_{GEth}	$I_C = 0.15 \text{ mA}, V_{CE} = V_{GE}$	4.8	5.6	6.4	V
Zero gate-voltage collector current	I_{CES}	$V_{GE} = 0 \text{ V}, V_{CE} = 650 \text{ V}$	$T_{vj} = 25 \text{ °C}$		30	μA
			$T_{vj} = 150 \text{ °C}$		360	
Gate-emitter leakage current	I_{GES}	$V_{CE} = 0 \text{ V}, V_{GE} = 20 \text{ V}$			100	nA
Transconductance	g_{fs}	$I_C = 8.5 \text{ A}, V_{CE} = 20 \text{ V}, T_{vj} \geq 25 \text{ °C}$		8.7		S
Short-circuit collector current	I_{SC}	$V_{CC} \leq 360 \text{ V}, V_{GE} = 15 \text{ V}, t_{SC} \leq 3 \mu\text{s}$, Allowed number of short circuits < 1000 , Time between short circuits $\geq 1.0 \text{ s}$, $T_{vj} = 150 \text{ °C}$		80		A
Input capacitance	C_{ies}	$V_{CE} = 25 \text{ V}, V_{GE} = 0 \text{ V}, f = 1000 \text{ kHz}$		790		pF
Output capacitance	C_{oes}	$V_{CE} = 25 \text{ V}, V_{GE} = 0 \text{ V}, f = 1000 \text{ kHz}$		41		pF
Reverse transfer capacitance	C_{res}	$V_{CE} = 25 \text{ V}, V_{GE} = 0 \text{ V}, f = 1000 \text{ kHz}$		12		pF
Gate charge	Q_G	$I_C = 8.5 \text{ A}, V_{GE} = 15 \text{ V}$		27		nC
Turn-on delay time	t_{don}	$V_{CE} = 400 \text{ V}, V_{GE} = 15 \text{ V}, R_{Gon} = 47.0 \Omega, R_{Goff} = 47.0 \Omega, L_\sigma = 30 \text{ nH}, C_\sigma = 150 \text{ pF}$	$T_{vj} = 25 \text{ °C}, I_C = 8.5 \text{ A}$	30		ns
			$T_{vj} = 150 \text{ °C}, I_C = 8.5 \text{ A}$	27		
Rise time (inductive load)	t_r	$V_{CE} = 400 \text{ V}, V_{GE} = 15 \text{ V}, R_{Gon} = 47.0 \Omega, R_{Goff} = 47.0 \Omega, L_\sigma = 30 \text{ nH}, C_\sigma = 150 \text{ pF}$	$T_{vj} = 25 \text{ °C}, I_C = 8.5 \text{ A}$	18		ns
			$T_{vj} = 150 \text{ °C}, I_C = 8.5 \text{ A}$	18		
Turn-off delay time	t_{doff}	$V_{CE} = 400 \text{ V}, V_{GE} = 15 \text{ V}, R_{Gon} = 47.0 \Omega, R_{Goff} = 47.0 \Omega, L_\sigma = 30 \text{ nH}, C_\sigma = 150 \text{ pF}$	$T_{vj} = 25 \text{ °C}, I_C = 8.5 \text{ A}$	106		ns
			$T_{vj} = 150 \text{ °C}, I_C = 8.5 \text{ A}$	123		
Fall time (inductive load)	t_f	$V_{CE} = 400 \text{ V}, V_{GE} = 15 \text{ V}, R_{Gon} = 47.0 \Omega, R_{Goff} = 47.0 \Omega, L_\sigma = 30 \text{ nH}, C_\sigma = 150 \text{ pF}$	$T_{vj} = 25 \text{ °C}, I_C = 8.5 \text{ A}$	46		ns
			$T_{vj} = 150 \text{ °C}, I_C = 8.5 \text{ A}$	72		

(table continues...)

Table 3 (continued) Characteristic values

Parameter	Symbol	Note or test condition	Values			Unit
			Min.	Typ.	Max.	
Turn-on energy	E_{on}	$V_{CE} = 400\text{ V}, V_{GE} = 15\text{ V},$ $R_{Gon} = 47.0\ \Omega,$ $R_{Goff} = 47.0\ \Omega,$ $L_{\sigma} = 30\text{ nH}, C_{\sigma} = 150\text{ pF}$	$T_{vj} = 25\text{ }^{\circ}\text{C},$ $I_C = 8.5\text{ A}$	0.2		mJ
			$T_{vj} = 150\text{ }^{\circ}\text{C},$ $I_C = 8.5\text{ A}$	0.22		
Turn-off energy	E_{off}	$V_{CE} = 400\text{ V}, V_{GE} = 15\text{ V},$ $R_{Gon} = 47.0\ \Omega,$ $R_{Goff} = 47.0\ \Omega,$ $L_{\sigma} = 30\text{ nH}, C_{\sigma} = 150\text{ pF}$	$T_{vj} = 25\text{ }^{\circ}\text{C},$ $I_C = 8.5\text{ A}$	0.07		mJ
			$T_{vj} = 150\text{ }^{\circ}\text{C},$ $I_C = 8.5\text{ A}$	0.13		
Total switching energy	E_{ts}	$V_{CE} = 400\text{ V}, V_{GE} = 15\text{ V},$ $R_{Gon} = 47.0\ \Omega,$ $R_{Goff} = 47.0\ \Omega,$ $L_{\sigma} = 30\text{ nH}, C_{\sigma} = 150\text{ pF}$	$T_{vj} = 25\text{ }^{\circ}\text{C},$ $I_C = 8.5\text{ A}$	0.27		mJ
			$T_{vj} = 150\text{ }^{\circ}\text{C},$ $I_C = 8.5\text{ A}$	0.35		
IGBT thermal resistance, junction to case	R_{thjc}				4.6	K/W
IGBT thermal resistance, junction to heat sink	R_{thjh}				4.60	K/W
Operating junction temperature	T_{vj}		-40		175	$^{\circ}\text{C}$

1) Measured with filter network.

Note: Electrical Characteristic, at $T_{vj} = 25^{\circ}\text{C}$, unless otherwise specified.

3 Diode

Table 4 Maximum rated values

Parameter	Symbol	Note or test condition	Values	Unit	
Repetitive peak reverse voltage	V_{RRM}	$T_{vj} \geq 25\text{ }^{\circ}\text{C}$	650	V	
Diode forward current, limited by T_{vjmax} ¹⁾	I_F		$T_h = 25\text{ }^{\circ}\text{C}$	19.5	A
			$T_h = 100\text{ }^{\circ}\text{C}$	11	
Diode pulsed current, limited by T_{vjmax}	I_{Fpuls}		42.5	A	

1) Limited by maximum junction temperature. Applicable for TO220 standard package.

Table 5 Characteristic values

Parameter	Symbol	Note or test condition		Values			Unit
				Min.	Typ.	Max.	
Diode forward voltage	V_F	$I_F = 8.5 \text{ A}$	$T_{vj} = 25 \text{ °C}$		1.45	1.9	V
					1.43		
					1.39		
Reverse leakage current	I_R	$V_R = 650 \text{ V}$	$T_{vj} = 25 \text{ °C}$			30	μA
					360		
Diode reverse recovery time	t_{rr}	$V_R = 400 \text{ V}$	$T_{vj} = 25 \text{ °C}$, $I_F = 8.5 \text{ A}$, $-di_F/dt = 450 \text{ A}/\mu\text{s}$		51		ns
					92		
Diode reverse recovery charge	Q_{rr}	$V_R = 400 \text{ V}$	$T_{vj} = 25 \text{ °C}$, $I_F = 8.5 \text{ A}$, $-di_F/dt = 450 \text{ A}/\mu\text{s}$		0.206		μC
					0.455		
Diode peak reverse recovery current	I_{rrm}	$V_R = 400 \text{ V}$	$T_{vj} = 25 \text{ °C}$, $I_F = 8.5 \text{ A}$, $-di_F/dt = 450 \text{ A}/\mu\text{s}$		5.7		A
					7.8		
Diode peak rate of fall of reverse recovery current	di_{rr}/dt	$V_R = 400 \text{ V}$	$T_{vj} = 25 \text{ °C}$, $I_F = 8.5 \text{ A}$, $-di_F/dt = 450 \text{ A}/\mu\text{s}$		-440		$\text{A}/\mu\text{s}$
					-205		
Diode thermal resistance, junction to case	R_{thjc}					6.4	K/W
Diode thermal resistance, junction to heat sink	R_{thjh}					6.40	K/W
Operating junction temperature	T_{vj}			-40		175	$^{\circ}\text{C}$

Note: For optimum lifetime and reliability, Infineon recommends operating conditions that do not exceed 80% of the maximum ratings stated in this datasheet.

4 Characteristics diagrams

Forward bias safe operating area, IGBT

$$I_C = f(V_{CE})$$

$$D = 0, T_{vj} \leq 175\text{ °C}, V_{GE} \geq 15\text{ V}, T_h = 25\text{ °C}$$

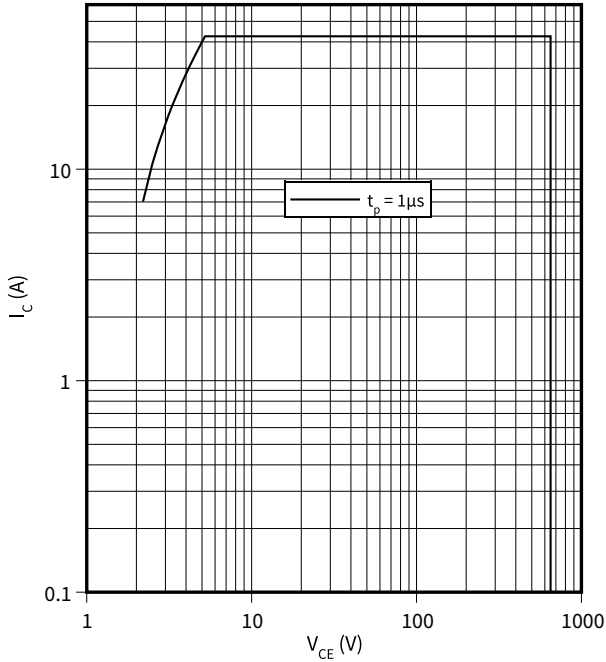

Power dissipation as a function of case temperature, IGBT

$$P_{tot} = f(T_c)$$

$$T_{vj} \leq 175\text{ °C}$$

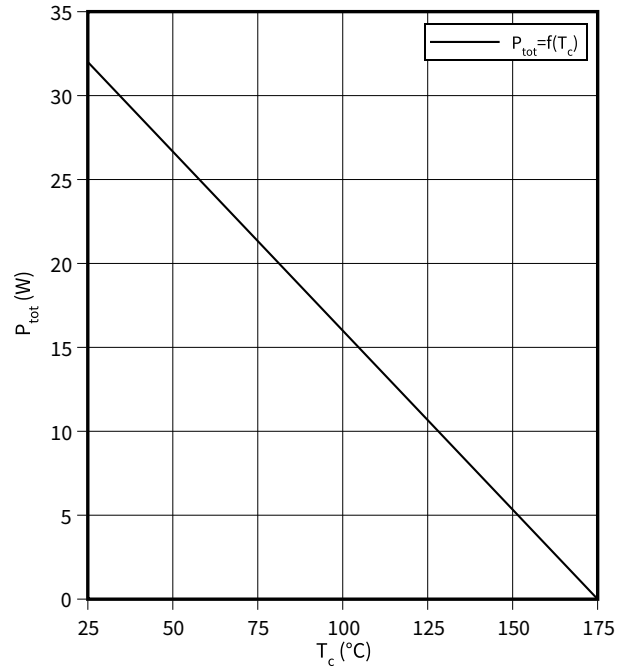

Collector current as a function of case temperature, IGBT

$$I_C = f(T_c)$$

$$T_{vj} \leq 175\text{ °C}, V_{GE} \geq 15\text{ V}$$

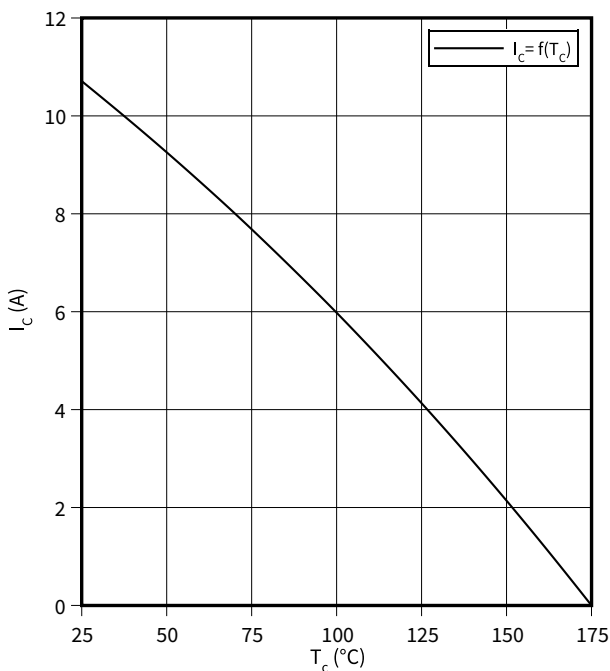

Typical output characteristic, IGBT

$$I_C = f(V_{CE})$$

$$T_{vj} = 25\text{ °C}$$

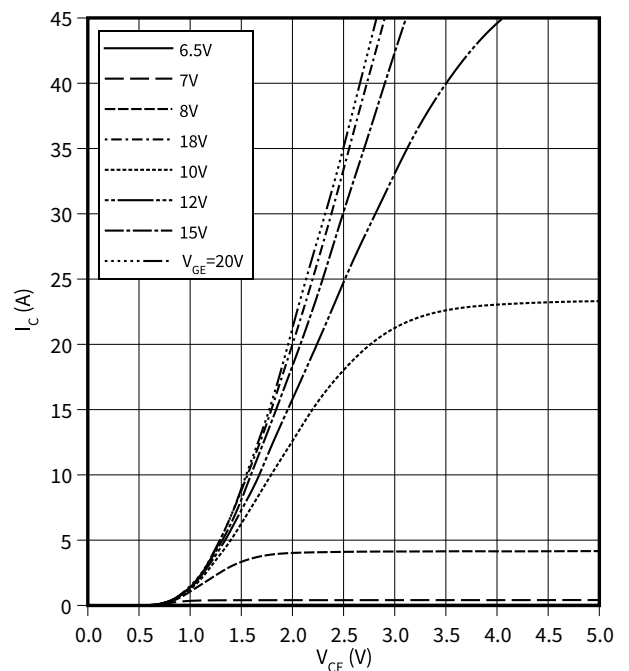

4 Characteristics diagrams

Typical output characteristic, IGBT

$I_C = f(V_{CE})$
 $T_{vj} = 150\text{ °C}$

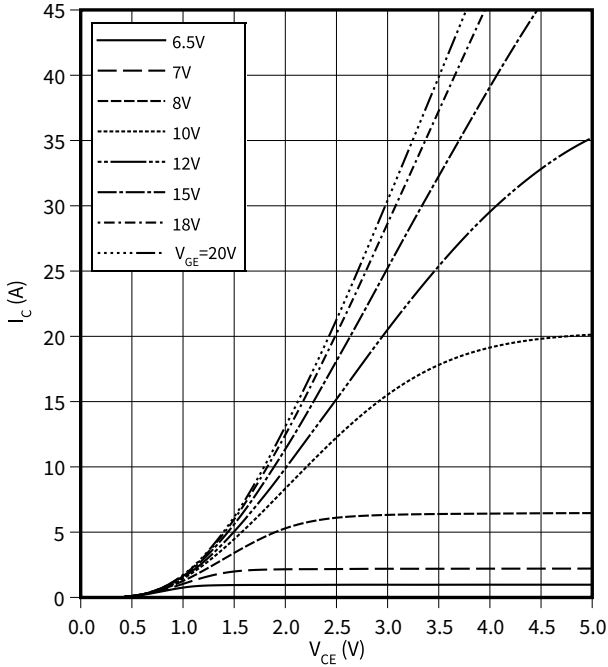

Typical transfer characteristic, IGBT

$I_C = f(V_{GE})$
 $V_{CE} = 50\text{ V}$

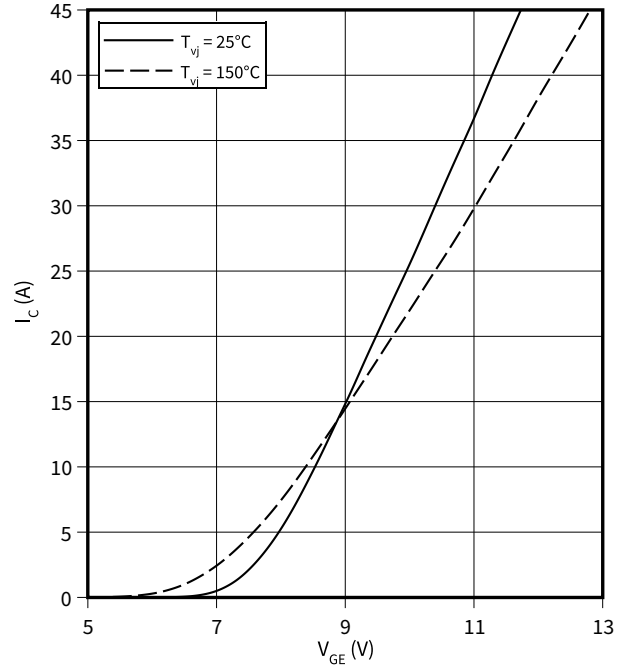

Typical collector-emitter saturation voltage as a function of junction temperature, IGBT

$V_{CEsat} = f(T_{vj})$
 $V_{GE} = 15\text{ V}$

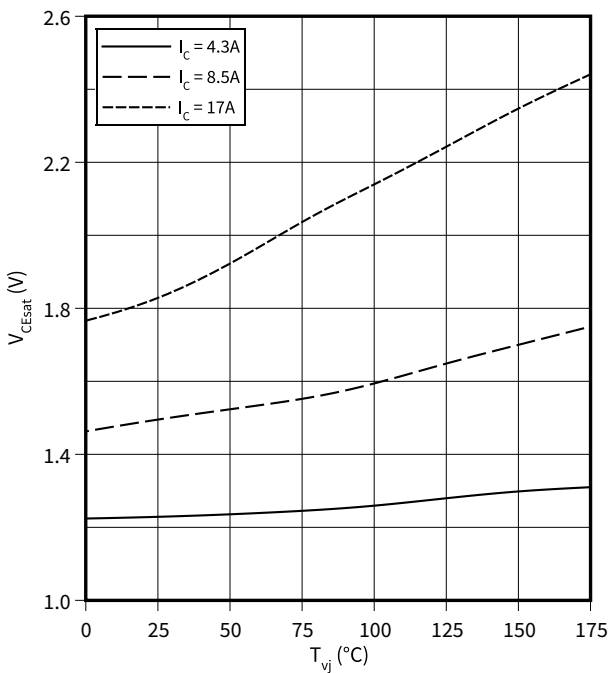

Gate-emitter threshold voltage as a function of junction temperature, IGBT

$V_{GEth} = f(T_{vj})$
 $I_C = 0.15\text{ mA}$

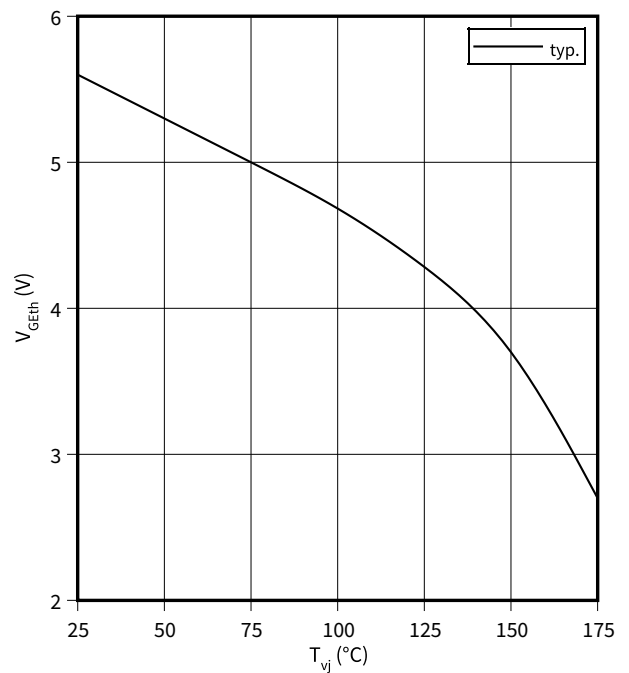

4 Characteristics diagrams

Typical switching times as a function of collector current, IGBT

$t = f(I_C)$

$V_{CE} = 400\text{ V}$, $T_{vj} = 150\text{ °C}$, $V_{GE} = 0/15\text{ V}$, $R_G = 47\text{ }\Omega$

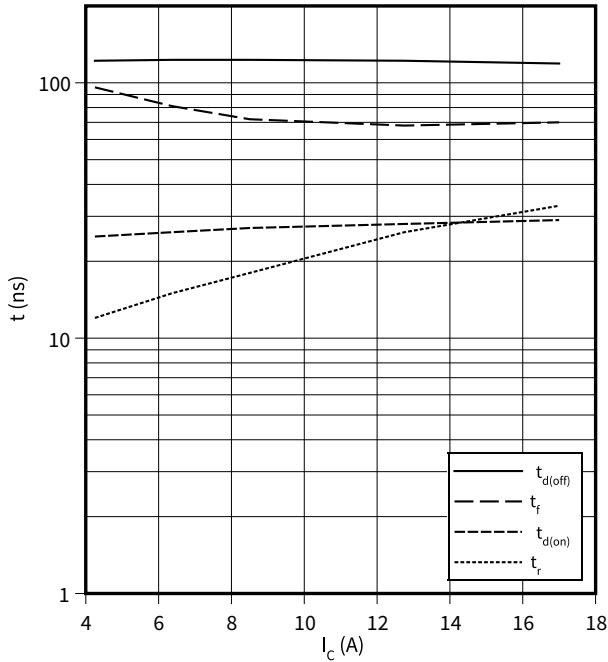

Typical switching times as a function of gate resistor, IGBT

$t = f(R_G)$

$I_C = 8.5\text{ A}$, $V_{CE} = 400\text{ V}$, $T_{vj} = 150\text{ °C}$, $V_{GE} = 0/15\text{ V}$

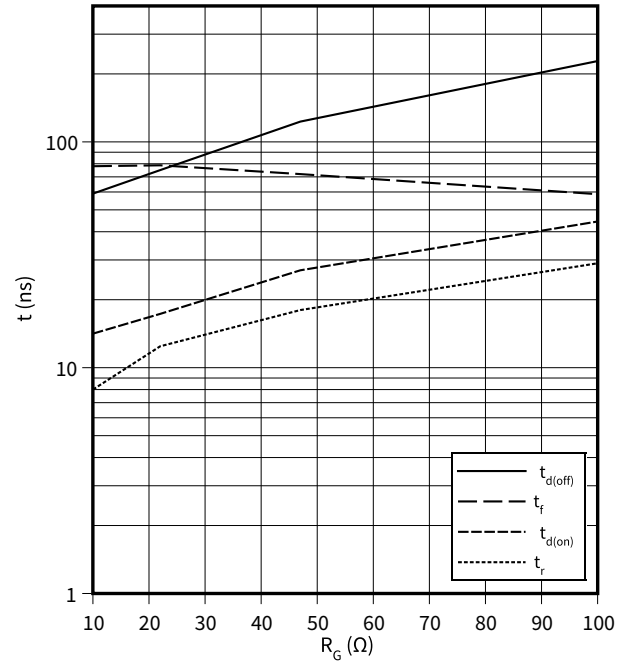

Typical switching times as a function of junction temperature, IGBT

$t = f(T_{vj})$

$I_C = 8.5\text{ A}$, $V_{CE} = 400\text{ V}$, $V_{GE} = 0/15\text{ V}$, $R_G = 47\text{ }\Omega$

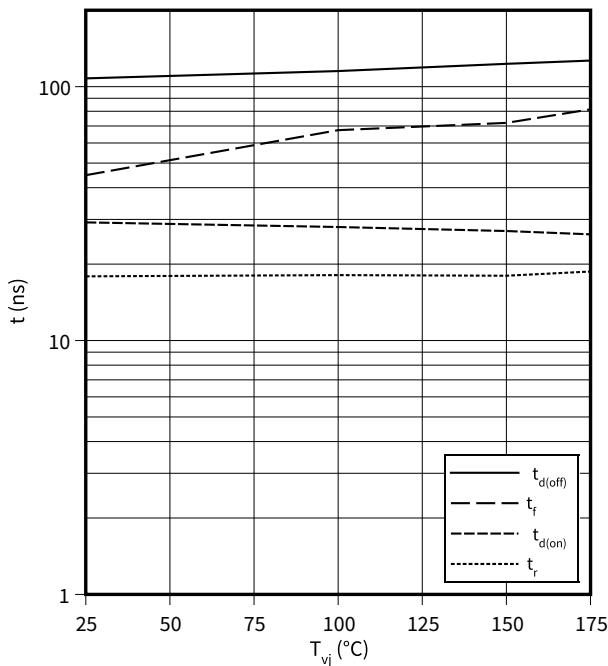

Typical switching energy losses as a function of collector current, IGBT

$E = f(I_C)$

$V_{CE} = 400\text{ V}$, $T_{vj} = 150\text{ °C}$, $V_{GE} = 0/15\text{ V}$, $R_G = 47\text{ }\Omega$

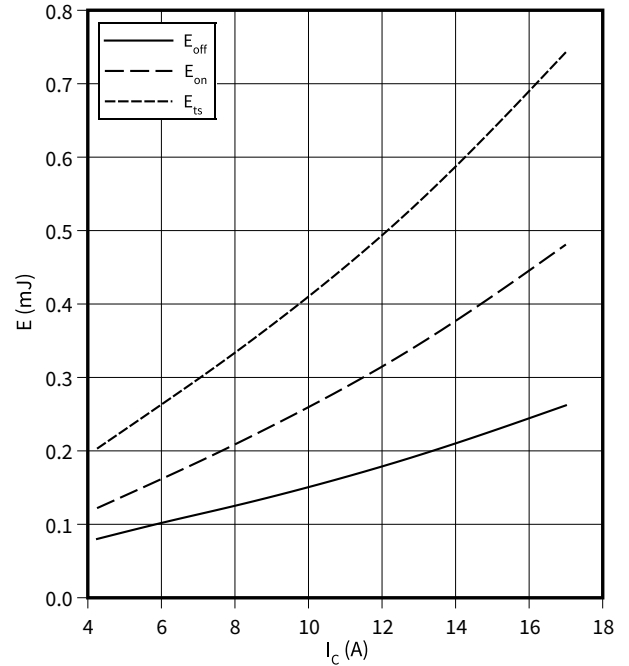

4 Characteristics diagrams

Typical switching energy losses as a function of gate resistor, IGBT

$E = f(R_G)$

$I_C = 8.5 \text{ A}$, $V_{CE} = 400 \text{ V}$, $T_{vj} = 150 \text{ °C}$, $V_{GE} = 0/15 \text{ V}$

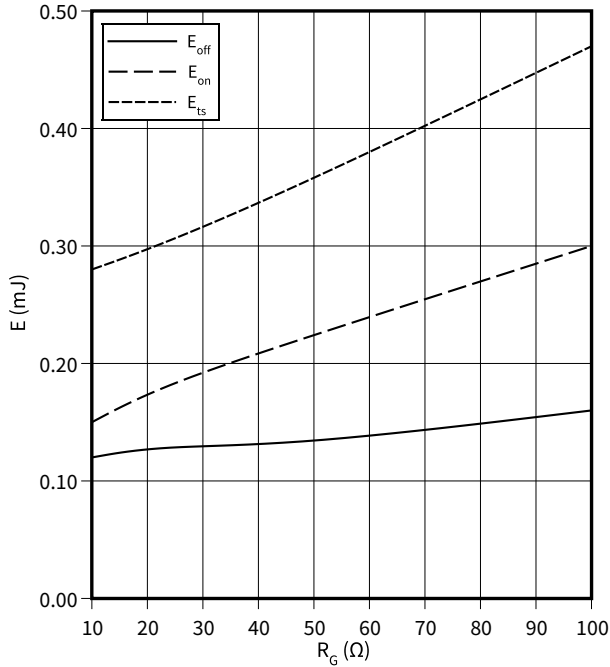

Typical switching energy losses as a function of junction temperature, IGBT

$E = f(T_{vj})$

$I_C = 8.5 \text{ A}$, $V_{CE} = 400 \text{ V}$, $V_{GE} = 0/15 \text{ V}$, $R_G = 47 \text{ Ω}$

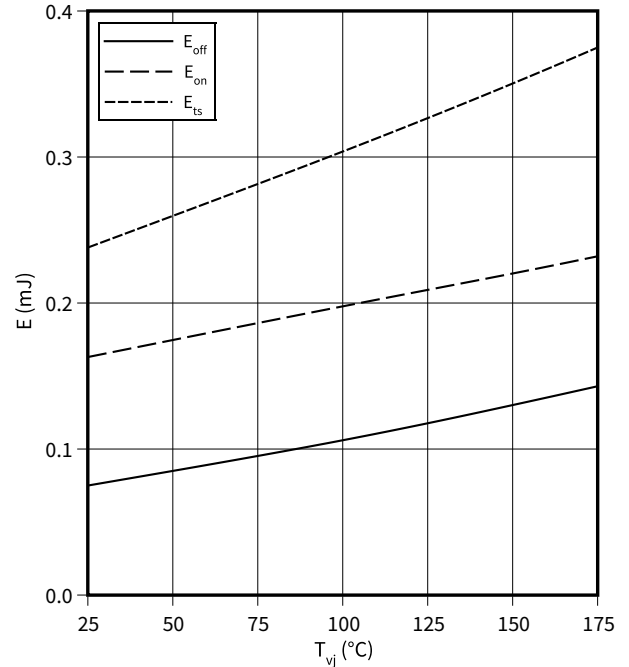

Typical switching energy losses as a function of collector emitter voltage, IGBT

$E = f(V_{CE})$

$I_C = 8.5 \text{ A}$, $V_{GE} = 0/15 \text{ V}$, $T_{vj} = 150 \text{ °C}$, $R_G = 47 \text{ Ω}$

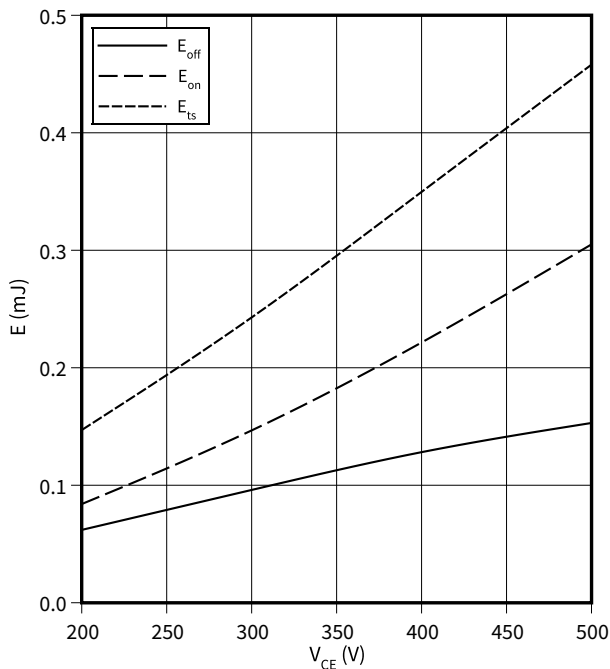

Typical gate charge, IGBT

$V_{GE} = f(Q_{GE})$

$I_C = 8.5 \text{ A}$

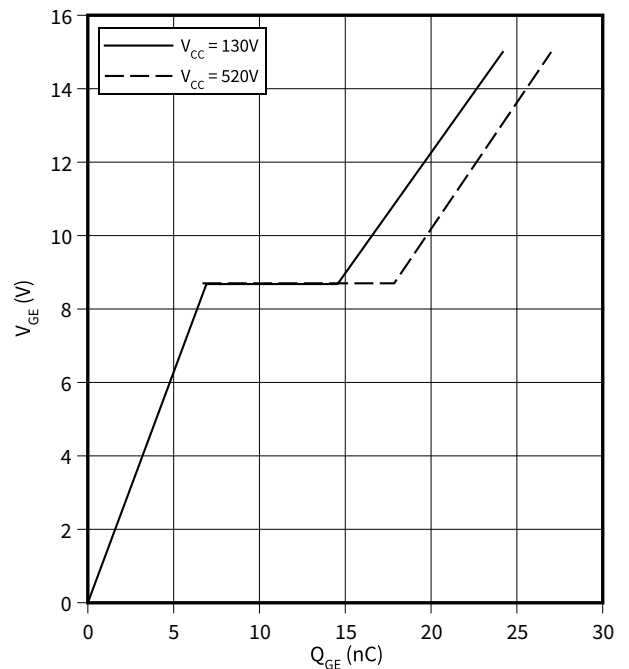

4 Characteristics diagrams

Typical capacitance as a function of collector-emitter voltage, IGBT

$C = f(V_{CE})$
 $f = 1000 \text{ kHz}, V_{GE} = 0 \text{ V}$

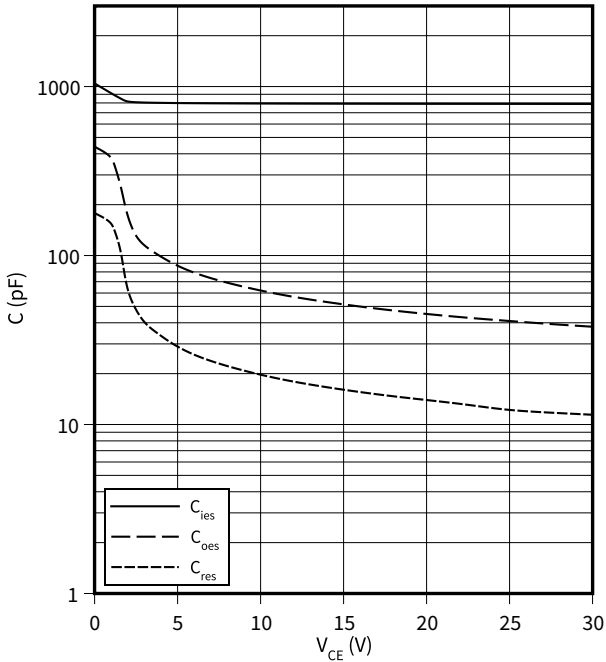

IGBT transient thermal impedance, IGBT

$Z_{th} = f(t_p)$
 $D = t_p/T$

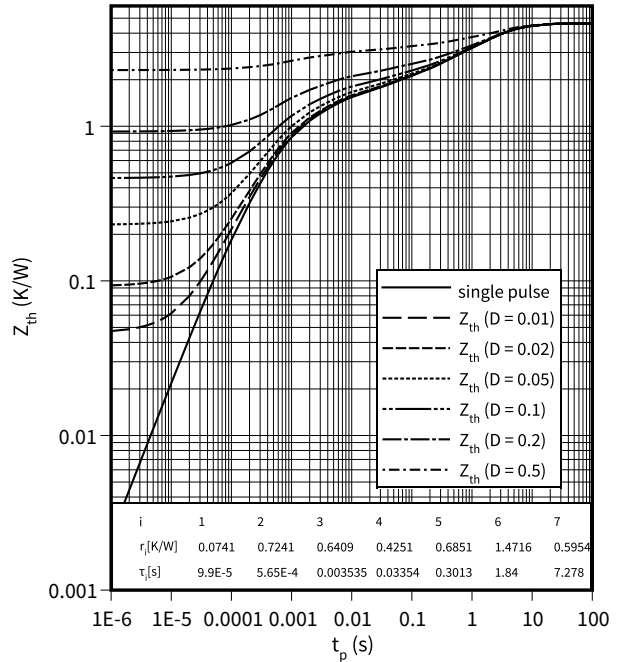

Diode transient thermal impedance as a function of pulse width, Diode

$Z_{th} = f(t_p)$
 $D = t_p/T$

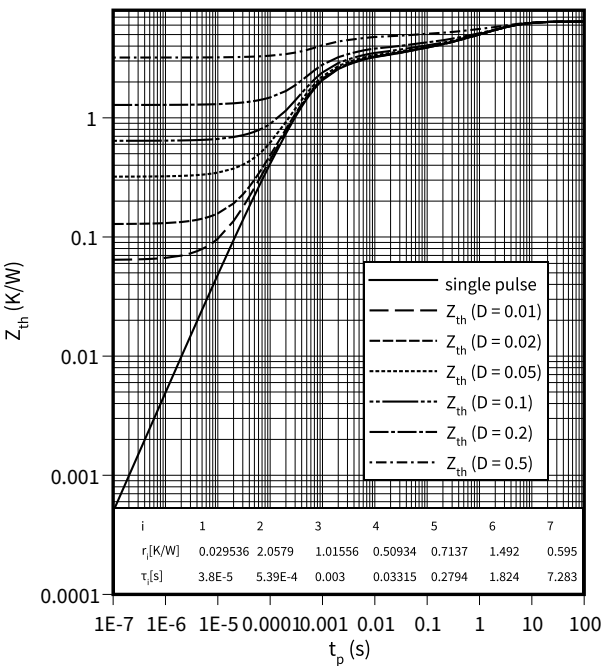

Typical diode forward current as a function of forward voltage, Diode

$I_F = f(V_F)$

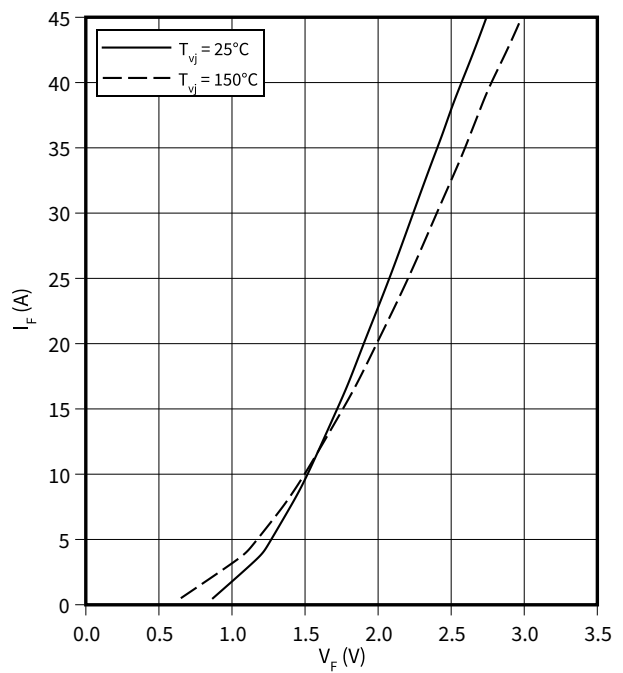

4 Characteristics diagrams

Typical diode forward voltage as a function of junction temperature, Diode

$V_F = f(T_{vj})$

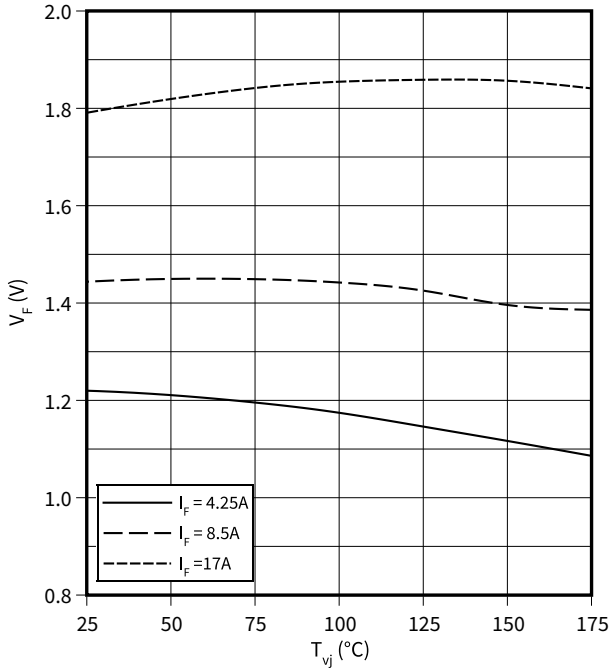

Typical reverse recovery time as a function of diode current slope, Diode

$t_{rr} = f(di_F/dt)$

$V_R = 400 V, I_F = 8.5 A$

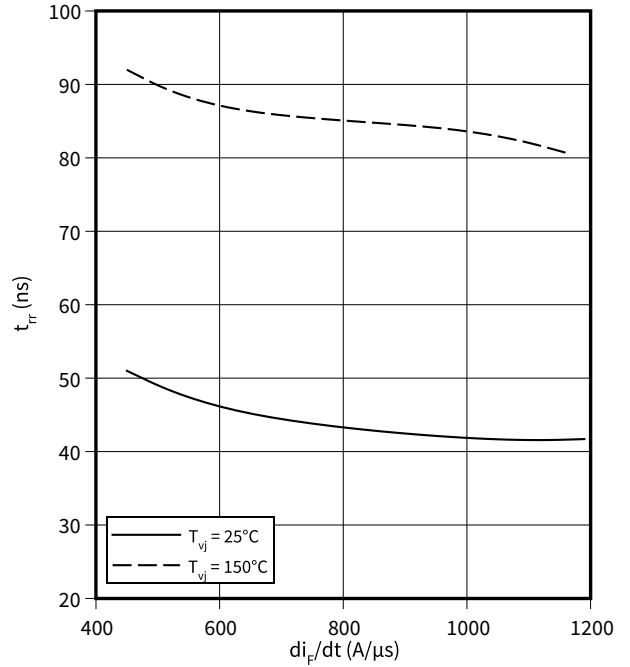

Typical reverse recovery charge as a function of diode current slope, Diode

$Q_{rr} = f(di_F/dt)$

$V_R = 400 V, I_F = 8.5 A$

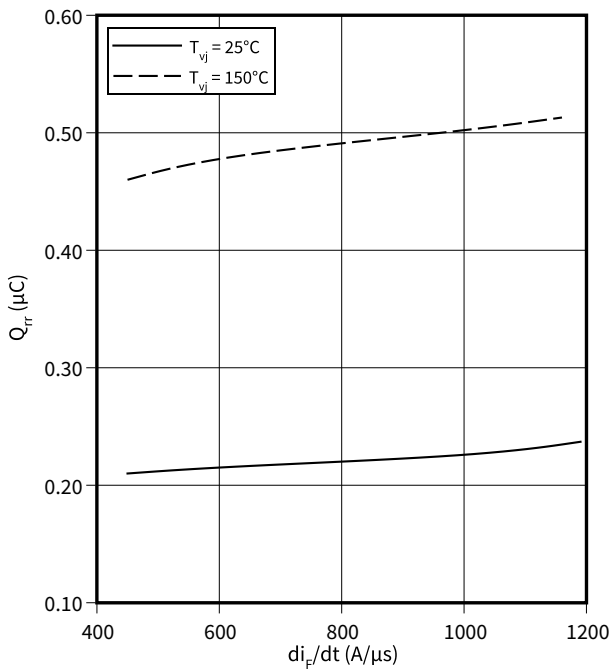

Typical reverse recovery current as a function of diode current slope, Diode

$I_{rr} = f(di_F/dt)$

$V_R = 400 V, I_F = 8.5 A$

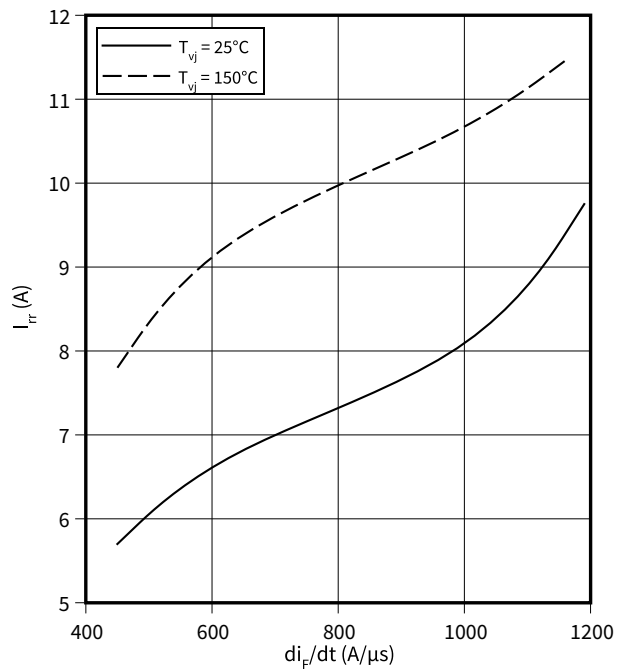

Typical diode peak rate of fall of reverse recovery current as a function of diode current slope, Diode

$dI_{rr}/dt = f(di_F/dt)$

$V_R = 400\text{ V}, I_F = 8.5\text{ A}$

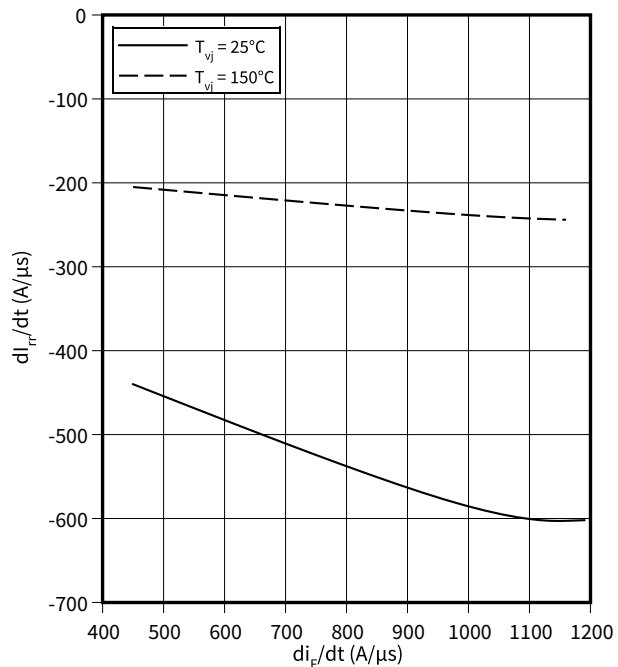

5 Package outlines

Package Drawing PG-TO220-3-FP

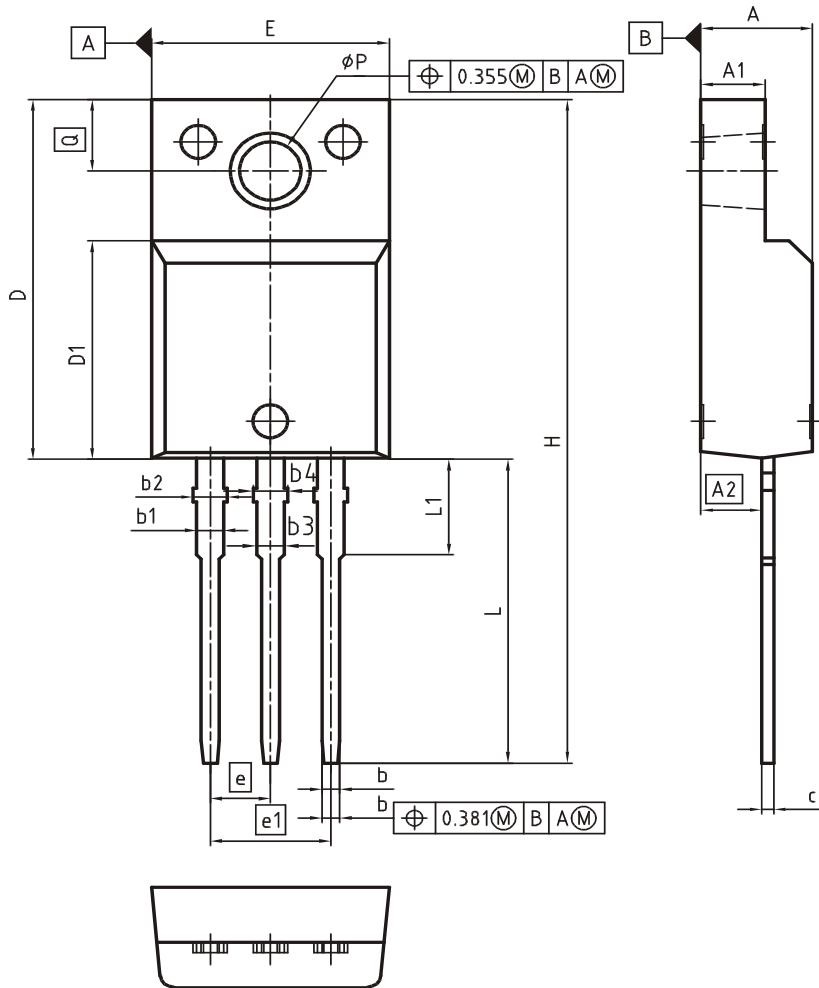

DIM	MILLIMETERS		INCHES	
	MIN	MAX	MIN	MAX
A	4.55	4.85	0.179	0.191
A1	2.55	2.85	0.100	0.112
A2	2.42	2.72	0.095	0.107
b	0.65	0.85	0.026	0.033
b1	0.95	1.33	0.037	0.052
b2	0.95	1.51	0.037	0.059
b3	0.65	1.33	0.026	0.052
b4	0.65	1.51	0.026	0.059
c	0.40	0.63	0.016	0.025
D	15.85	16.15	0.624	0.636
D1	9.53	9.83	0.375	0.387
E	10.35	10.65	0.407	0.419
e	2.54		0.100	
e1	5.08		0.200	
N	3		3	
H	29.45	29.75	1.159	1.171
L	13.45	13.75	0.530	0.541
L1	3.15	3.45	0.124	0.136
øP	2.95	3.20	0.116	0.126
Q	3.15	3.50	0.124	0.138

DOCUMENT NO.
Z8B00003319

SCALE

EUROPEAN PROJECTION

ISSUE DATE
08-03-2007

REVISION
03

Figure 1

6 Testing conditions

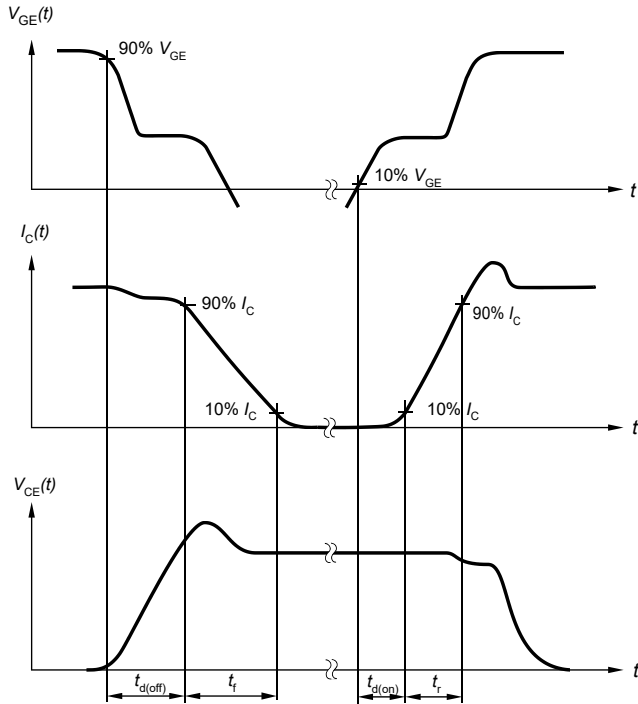

Figure A. Definition of switching times

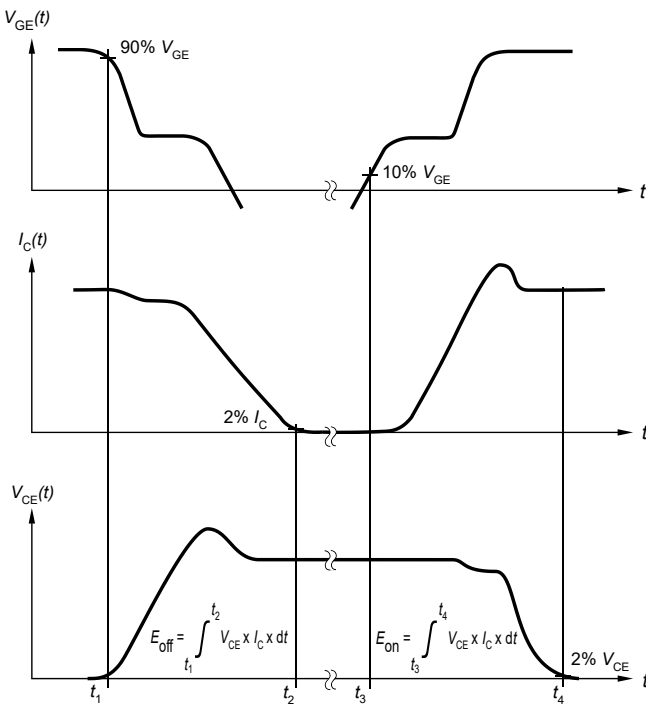

Figure B. Definition of switching losses

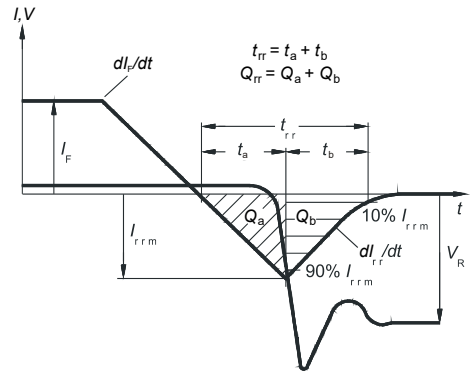

Figure C. Definition of diode switching characteristics

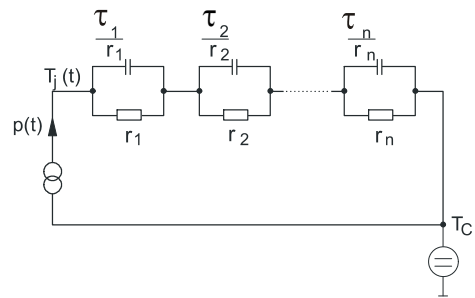

Figure D. Thermal equivalent circuit

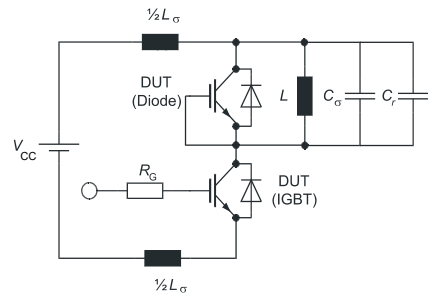

Figure E. Dynamic test circuit
Parasitic inductance L_{σ} ,
parasitic capacitor C_{σ} ,
relief capacitor C_r ,
(only for ZVT switching)

Figure 2

Revision history

Document revision	Date of release	Description of changes
V2.1	2017-09-11	Final Datasheet
V2.2	2017-11-30	New Gfs Value at VCE=20V
V2.3	2019-09-13	Change of Rth/Zth values and maximum DC ratings
1.00	2021-10-18	Change of unit in thermal impedance figures

Trademarks

All referenced product or service names and trademarks are the property of their respective owners.

Edition 2021-10-18

Published by

Infineon Technologies AG

81726 Munich, Germany

© 2021 Infineon Technologies AG

All Rights Reserved.

Do you have a question about any aspect of this document?

Email: erratum@infineon.com

Document reference

IFX-AAL160-004

IMPORTANT NOTICE

The information given in this document shall in no event be regarded as a guarantee of conditions or characteristics ("Beschaffheitsgarantie").

With respect to any examples, hints or any typical values stated herein and/or any information regarding the application of the product, Infineon Technologies hereby disclaims any and all warranties and liabilities of any kind, including without limitation warranties of non-infringement of intellectual property rights of any third party.

In addition, any information given in this document is subject to customer's compliance with its obligations stated in this document and any applicable legal requirements, norms and standards concerning customer's products and any use of the product of Infineon Technologies in customer's applications.

The data contained in this document is exclusively intended for technically trained staff. It is the responsibility of customer's technical departments to evaluate the suitability of the product for the intended application and the completeness of the product information given in this document with respect to such application.

Please note that this product is not qualified according to the AEC Q100 or AEC Q101 documents of the Automotive Electronics Council.

WARNINGS

Due to technical requirements products may contain dangerous substances. For information on the types in question please contact your nearest Infineon Technologies office.

Except as otherwise explicitly approved by Infineon Technologies in a written document signed by authorized representatives of Infineon Technologies, Infineon Technologies' products may not be used in any applications where a failure of the product or any consequences of the use thereof can reasonably be expected to result in personal injury.