

Spring plunger

FSTE G1/2-AG 90

Part no...:10.01.02.00576

<https://www.schmalz.com/10.01.02.00576>

Home > Vacuum Technology for Automation > Vacuum Components > Mounting Elements > Spring Plungers > Spring Plungers FSTE > FSTE G1/2-AG 90

Spring plunger with damping and height compensation



Suction cup connection: G1/2"-M

Vacuum connection: G3/8"-F

Spring stroke Z: 90 mm

Design Data

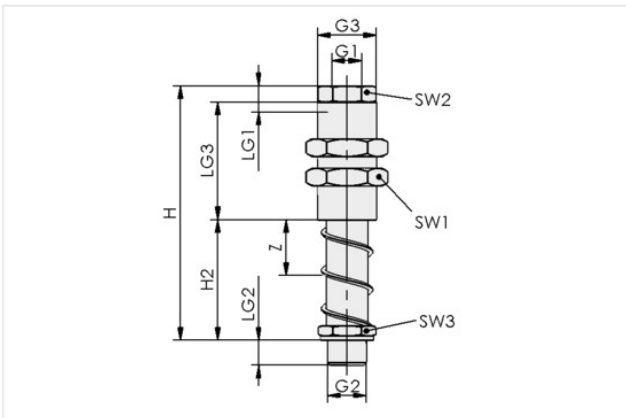

Attribute	Value
G1	G3/8"-F
G2	G1/2"-M
G3	M30x1.5-M
H	188.50 mm
H2	125.50 mm
LG1	13 mm
LG2	10.50 mm
LG3	55 mm
SW1	36 mm
SW2	24 mm
SW3	24 mm
Z (Stroke)	90 mm

Technical Data

Attribute	Value
Spring rate	1.07 N/mm
Spring pretension	24.38 N
Spring force, center	75.30 N
Vertical load	4900 N
Horizontal load	730 N
Weight	544 g

Contact Schmalz

Schmalz Inc. | 5850 Oak Forest Drive, Raleigh, NC 27616, United States | +1 (919) 713-0880 | schmalz.us@schmalz.com

Spring plunger

FSTE G1/2-AG 90

Part no...:10.01.02.00576

<https://www.schmalz.com/10.01.02.00576>

Operating temperature	0 ... 80 °C
Product family	FSTE

Note: Spring force: Referred to 50 % of operating stroke Vertical loading: Maximum static loading Horizontal stress: The specification of the horizontal stress refers to the lower edge of the plunger with extended spring. It is a maximum static stress and it impairs the spring compression and extension in horizontal position

Accessories



FLK G1/2-IG G1/2-AG

Part no...:10.01.03.00175

Thread G1: G1/2"-F

Thread G2: G1/2"-M

Operating temperature: 0 ... 70 °C



FLK G1/2-IG G1/2-AG V

Part no...:10.01.03.00207

Thread G1: G1/2"-F

Thread G2: G1/2"-M

Operating temperature: 0 ... 70 °C

Shape mounting elements: Reinforced

Spring plunger

FSTE G1/2-AG 90

Part no...:10.01.02.00576

<https://www.schmalz.com/10.01.02.00576>



KGL G1/2-IG G1/2-AG

Part no...:10.01.03.00111

Thread G1: G1/2"-F

Thread G2: G1/2"-M

Height H: 40 mm



HTR-STA 62 1N D30 WI

Part no...:10.08.03.00148

Length L: 62 mm

Connection 1: Sliding block

Connection of suction cup, spring plunger: Contour D30-G1/2

Shape: angled



HTR-ST5 40x40 D30 WI

Part no...:10.08.03.00090

Connection 1: 40x40

Connection of suction cup, spring plunger: Contour D30-G1/2

Shape: angled

Spring plunger

FSTE G1/2-AG 90

Part no...:10.01.02.00576

<https://www.schmalz.com/10.01.02.00576>



HTR-ST5 50x50 D30 WI

Part no...:10.08.03.00091

Connection 1: 50x50

Connection of suction cup, spring plunger: Contour D30-G1/2

Shape: angled



HTR-ST5 60x60 D30 WI

Part no...:10.08.03.00092

Connection 1: 60x60

Connection of suction cup, spring plunger: Contour D30-G1/2

Shape: angled



ST G3/8-AG 9 MS-V

Part no...:10.08.03.00159

Thread G1: G3/8"-M

Hose diameter (empf.) d: 9 mm

Material: Brass

Surface: nickel plated

Length L: 6 mm

Nominal diameter dn: 7.4 mm

Spring plunger

FSTE G1/2-AG 90

Part no...:10.01.02.00576

<https://www.schmalz.com/10.01.02.00576>



ST G3/8-AG 13 MS-V

Part no...:10.08.03.00160

Thread G1: G3/8"-M

Hose diameter (empf.) d: 13 mm

Material: Brass

Surface: nickel plated

Length L: 5.9 mm

Nominal diameter dn: 10 mm



STV-GE G3/8-AG 8

Part no...:10.08.02.00237

Thread G1: G3/8"-M

Hose diameter: 8 mm

Material: Brass

Operating temperature: -20 ... 80 °C

External diameter D: 14.6 mm

Length L: 17.4 mm



STV-GE G3/8-AG 10

Part no...:10.08.02.00252

Thread G1: G3/8"-M

Hose diameter: 10 mm

Material: Brass

Operating temperature: -20 ... 80 °C

External diameter D: 16.5 mm

Length L: 20.1 mm

Spring plunger

FSTE G1/2-AG 90

Part no...:10.01.02.00576

<https://www.schmalz.com/10.01.02.00576>



STV-GE G3/8-AG 12

Part no...:10.08.02.00209

Thread G1: G3/8"-M

Hose diameter: 12 mm

Material: Brass

Operating temperature: -20 ... 80 °C

External diameter D: 19.5 mm

Length L: 23.6 mm



STV-GE G3/8-AG 14

Part no...:10.08.02.00211

Thread G1: G3/8"-M

Hose diameter: 14 mm

Material: Brass

Operating temperature: -20 ... 80 °C

External diameter D: 21.5 mm

Length L: 30.5 mm



STV-W G3/8-AG 8

Part no...:10.08.02.00236

Thread G1: G3/8"-M

Hose diameter: 8 mm

Material: Nickel plated

Operating temperature: -20 ... 80 °C

Length L: 23.7 mm

Spring plunger

FSTE G1/2-AG 90

Part no...:10.01.02.00576

<https://www.schmalz.com/10.01.02.00576>



STV-W G3/8-AG 10

Part no...:10.08.02.00255

Thread G1: G3/8"-M

Hose diameter: 10 mm

Material: Nickel plated

Operating temperature: -20 ... 80 °C

Length L: 35.1 mm



STV-W G3/8-AG 12

Part no...:10.08.02.00163

Thread G1: G3/8"-M

Hose diameter: 12 mm

Material: Nickel plated

Operating temperature: -20 ... 80 °C

Length L: 34.1 mm



STV-WF G3/8-AG 8

Part no...:10.08.02.00234

Thread G1: G3/8"-M

Hose diameter: 8 mm

Material: Nickel plated

Operating temperature: -10 ... 70 °C

Length L: 26.7 mm

Spring plunger

FSTE G1/2-AG 90

Part no...:10.01.02.00576

<https://www.schmalz.com/10.01.02.00576>



STV-WF G3/8-AG 10

Part no...:10.08.02.00259

Thread G1: G3/8"-M

Hose diameter: 10 mm

Material: Nickel plated

Operating temperature: -10 ... 70 °C

Length L: 29.2 mm

Spare parts

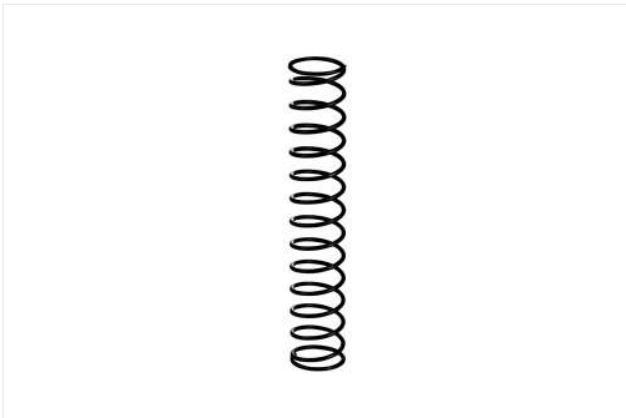

DRUCK-FED 2x23 139.5 1.072

Part no...:20.08.02.00097

Length L: 139.5 mm

Spring rate: 1.072 N/mm