

AT89STK-10 Starter Kit

Hardware User Guide





Section 1

Introduction	1-2
1.1 Features	1-2

Section 2

Hardware Description	2-10
Typical Applications	2-11
3.1 Nand Flash Application	2-12
3.2 Serial Dataflash Application	2-13

Section 3

Annex.....	3-14
4.1 Flash Evaluation Board	3-15
4.2 Nand Flash Add-on board	3-18



Section 1

Introduction

This document describes the Flash Evaluation Board dedicated to the AT89C5130/31A and the AT8xC5122D USB microcontrollers. This board is designed to enable an easy evaluation of the Mass Storage USB class using demonstration firmware (refer to firmware Guide). It must be plugged to a CPU board (AT89C5130/31A or AT8xC5122 D evaluation board).

1.1 Features

The Flash evaluation board provides the following features:

- Support the following microcontrollers :
 - AT89C5130A
 - AT89C5131A
 - AT8xC5122D
- No external power supply required
 - Power supplied by the USB line via the CPU board (AT89C5130/31A or AT8xC5122 D evaluation board)
- On board DataFlash memory (ATMEL AT45DB321B, 4MB)
- Support Nand Flash memory (MICRON MT29F2GO8AABWP, 256MB) - Add-on board
- Support Pluggable DataFlash Card (ATMEL AT45DCB004C, 4 MB)



Figure 1-1. Flash Evaluation Board

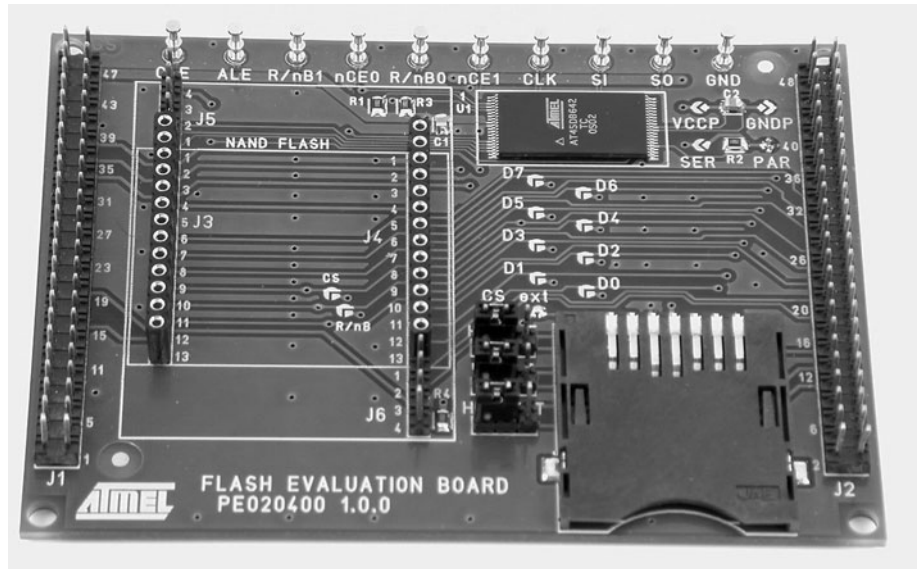
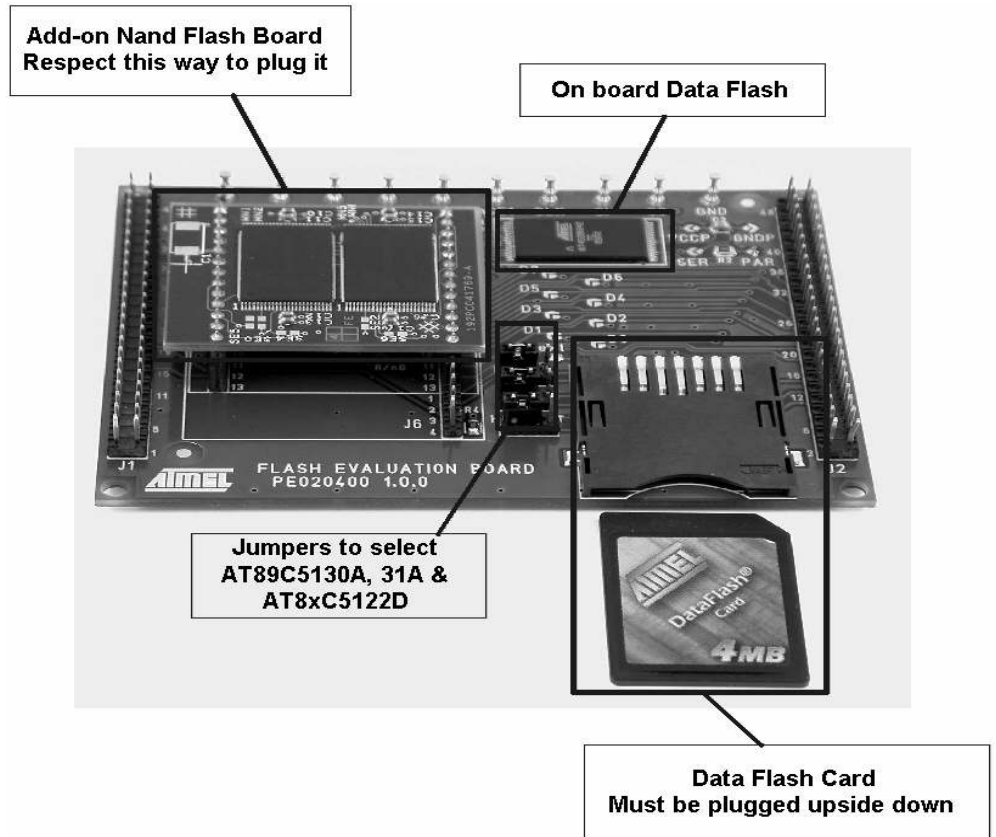


Figure 1-2. Flash Evaluation Board with the related memories



Section 2

Hardware Description

2.1 CPU board selection

As mentioned above, the Flash evaluation board can be used either with the AT89C5130/31A or AT8xC5122 D. The figure below show the jumpers state to enable each mode :

Figure 2-1. AT8xC5130/31AD Jumpers state

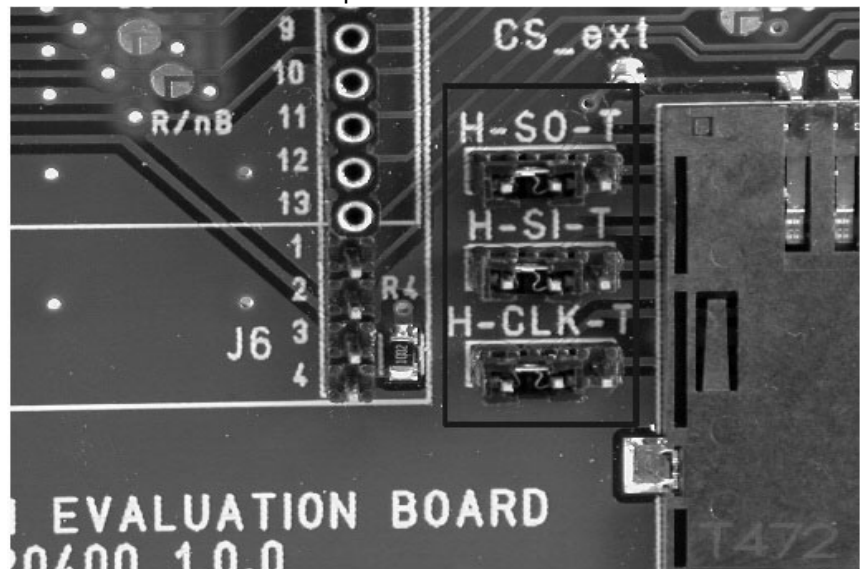
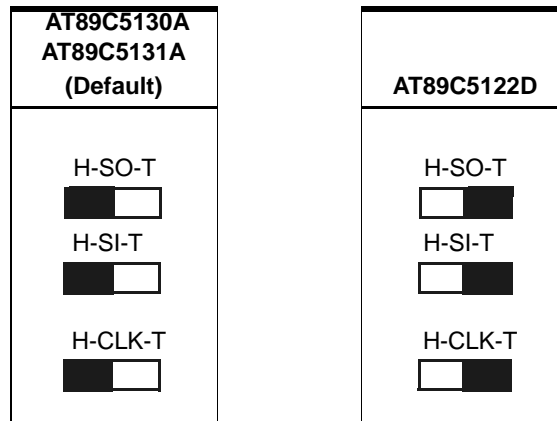


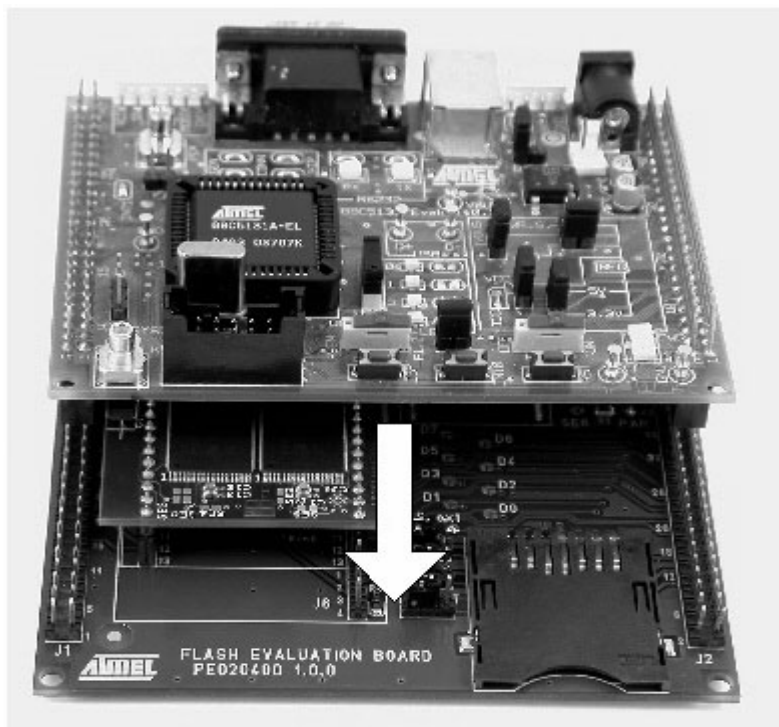
Figure 2-2. Jumpers state



The figures below show how to plug the Flash evaluation board to AT89C5130/31A or AT8xC5122 D evaluation board (AT89STK05 or AT89STK03) :

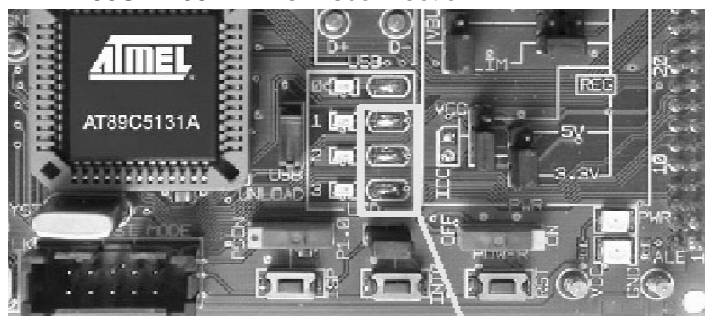


Figure 2-3. Flash evaluation board plugged to AT89C5130/31A evaluation board (AT89STK05)



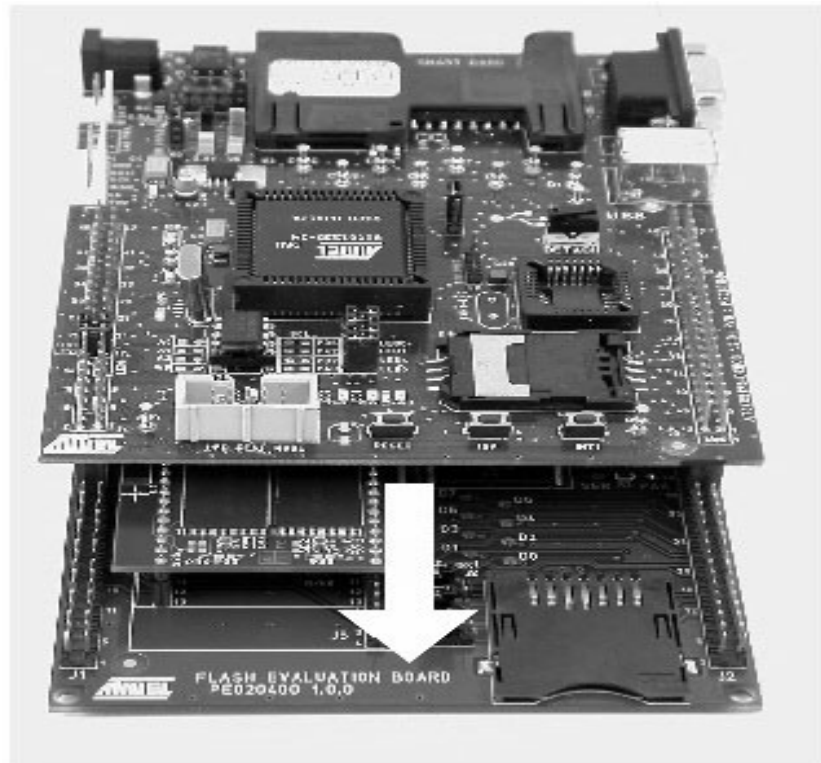
Warning : Before plugging the Flash Evaluation Board (AT89STK10) to the AT89C5130/31A evaluation board (AT89STK05), disconnect the three LEDs by removing the solder on solder straps. The figure below shows the location of these solder straps :

Figure 2-4. AT89STK-05 - LEDs Disconnection



Remove the solder on these solder straps

Figure 2-5. Flash evaluation board plugged to AT8xC5122D evaluation board (AT89STK03)



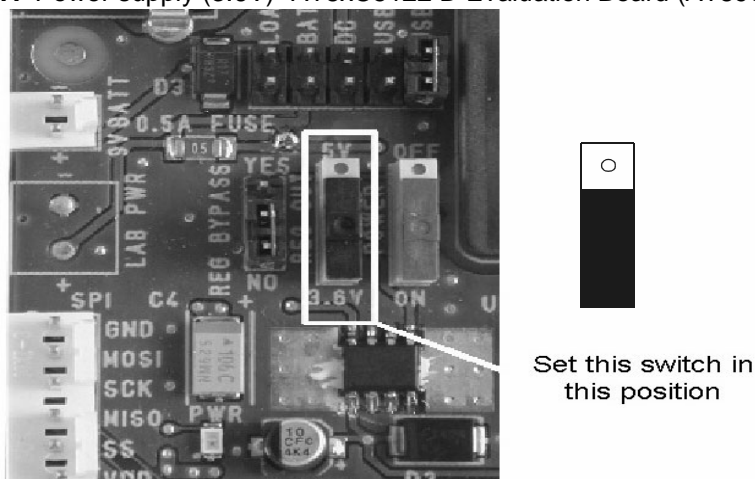
2.2 Power supply

The Flash Evaluation Board power is supplied by the CPU board. The power supply must be set to 3.3V for the AT89C5131A Evaluation board and 3.6V for the AT8xC5122D Evaluation board. The figure 2.5 shows the different possible configurations of the AT89C5130/31A Evaluation board (AT89STK05) and the figure 2.6 shows how to select 3.6V on the AT8xC5122D Evaluation board in the 3.6V power supply configuration :

Figure 2-6. Power supply (3.3V) - AT89C5131A Evaluation Board (AT89STK05)

Power Source Regulation	VBUS	VBUS and Current Limiter	External
Direct Input			
3.3V Regulate			

Figure 2-7. Power supply (3.6V)- AT8xC5122 D Evaluation Board (AT89STK03)



2.3 Memory selection

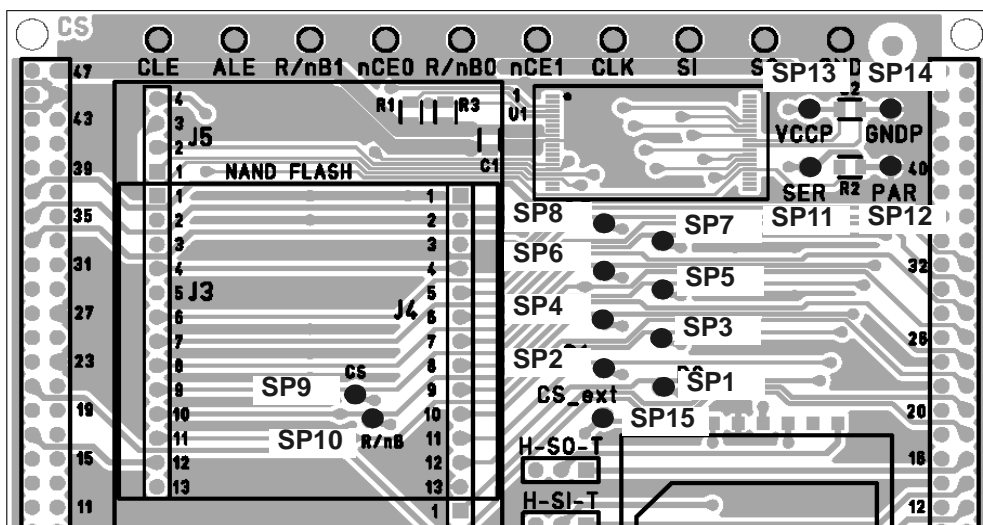
The Flash evaluation board supports three Flash memories (Pluggable Nand Flash, Pluggable DataFlash Card and On board DataFlash). Just one memory can be activated at the same time.

To configure the board with your specific usage, you have to put the solder straps in the right state.

Figure 2-8. Solder straps



Figure 2-9. Solder Straps location



The tables hereunder show the configuration related to each memory mode :

Table 1. Nand Flash Configuration (Default configuration)

Reference	Name	Function	State
SP1..8	D0..7	Connect Data P0 on onboard dataflash	Open
SP9	CS	Connect CS of internal dataflash	Open
SP10	R/nB	Connect R/nB on dataflash	Open
SP 11	SER	Select DataFlash in serial mode	Open
SP12	PAR	Select DataFlash in parallel mode	Open
SP 13	VccP	Connect power supply of parallel interface of DataFlash	Open
SP 14	GNDP	Connect ground of parallel interface of DataFlash	Open
SP 15	CS_ext	Connect CS of external dataflash	Open

Table 2. On Board DataFlash Configuration (Serial mode)

Reference	Name	Function	State
SP1..8	D0..7	Connect bus P0 on onboard dataflash	Open
SP9	CS	Connect CS of internal dataflash	Close
SP10	R/nB	Connect R/nB on dataflash	Close/Open
SP 11	SER	Select DataFlash in serial mode	Close
SP12	PAR	Select DataFlash in parallel mode	Open
SP 13	VccP	connect power supply of parallel interface of DataFlash	Open
SP 14	GNDP	connect gnd of parallel interface of DataFlash	Open
SP 15	CS_ext	Connect CS of external dataflash	Open

Table 3. On Board DataFlash Configuration (Parallel mode)

Reference	Name	Function	State
SP1..8	D0..7	connect bus P0 on onboard dataflash	Close
SP9	CS	Connect CS of internal dataflash	Close
SP10	R/nB	Connect R/nB on dataflash	Close
SP 11	SER	put DataFlash in serial mode	Open
SP12	PAR	put DataFlash in parallel mode	Close
SP 13	VccP	connect power supply of parallel interface of DataFlash	Close
SP 14	GNDP	connect gnd of parallel interface of DataFlash	Close
SP 15	CS_ext	Connect CS of external dataflash	Open

The firmware doesn't support this mode.

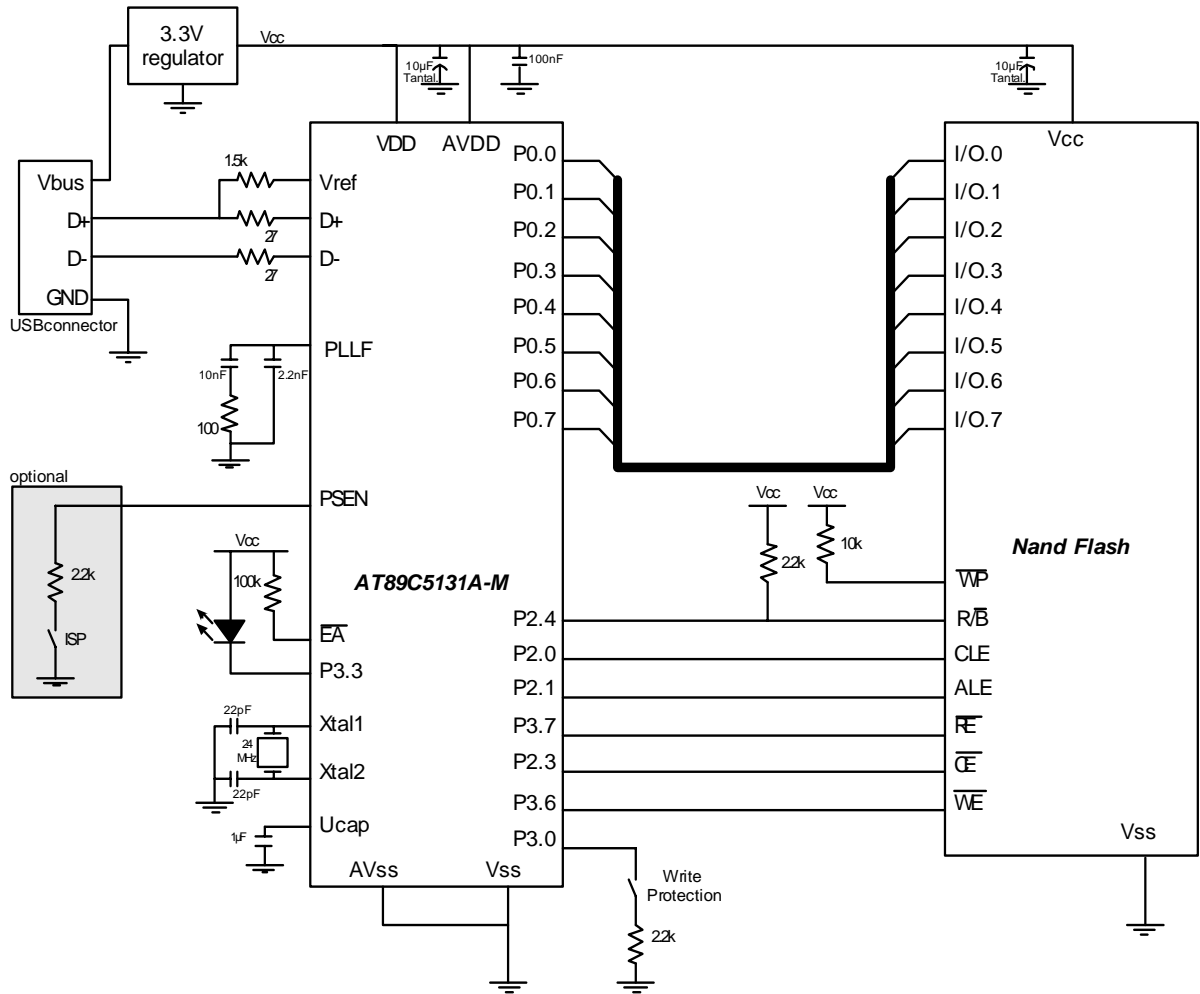
Table 4. Pluggable DataFlash Card Configuration

Reference	Name	Function	State
SP1..8	D0..7	connect bus P0 on onboard dataflash	Open
SP9	CS	Connect CS of internal dataflash	Open
SP10	R/nB	Connect R/nB on dataflash	Open
SP 11	SER	put DataFlash in serial mode	Open
SP12	PAR	put DataFlash in parallel mode	Open
SP 13	VccP	connect power supply of parallel interface of DataFlash	Open
SP 14	GNDP	connect gnd of parallel interface of DataFlash	Open
SP 15	CS_ext	Connect CS of external dataflash	Close

Section 3

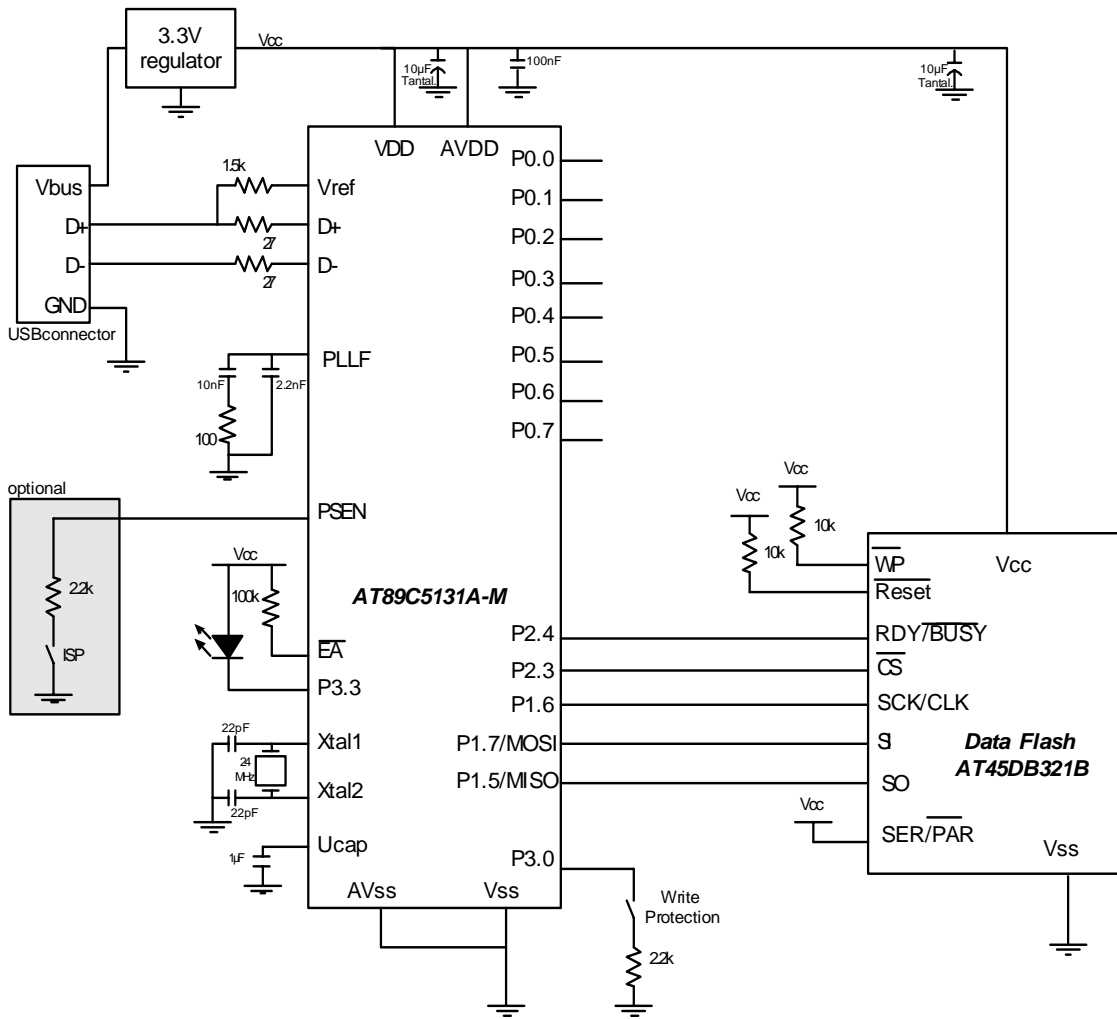
Typical Applications

3.1 Nand Flash Application

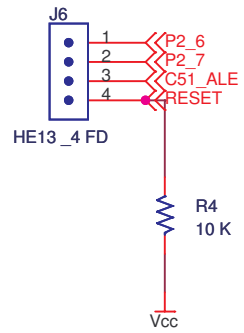
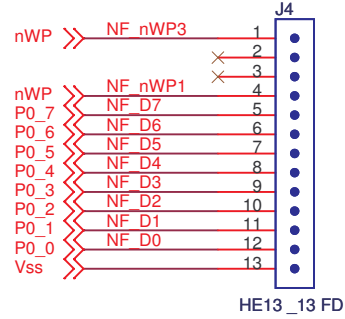
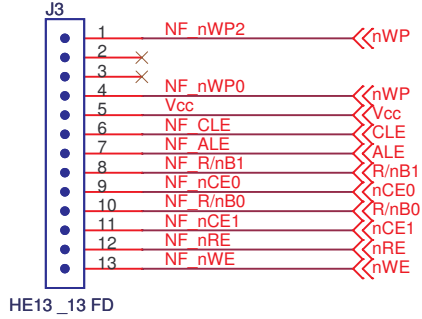
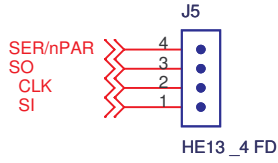




3.2 Serial Dataflash Application



4.1 Flash Evaluation Board



4.2 Nand Flash Add- *Figure 4-1. Schematic on board*

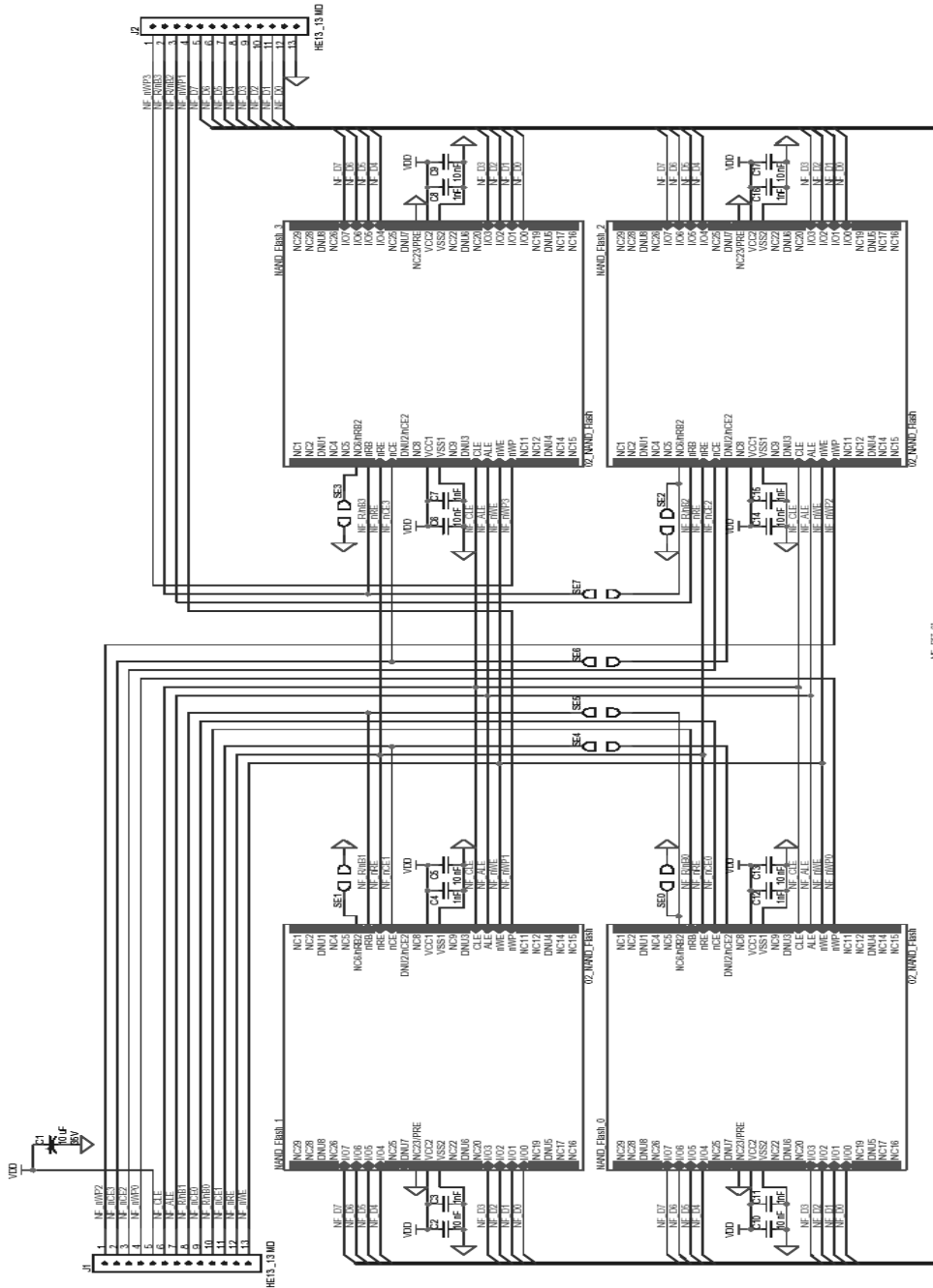


Figure 4-2. Component Side

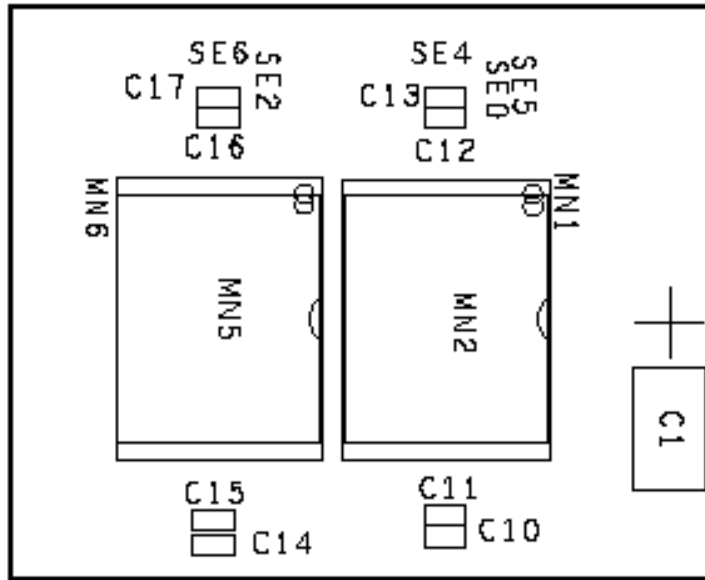
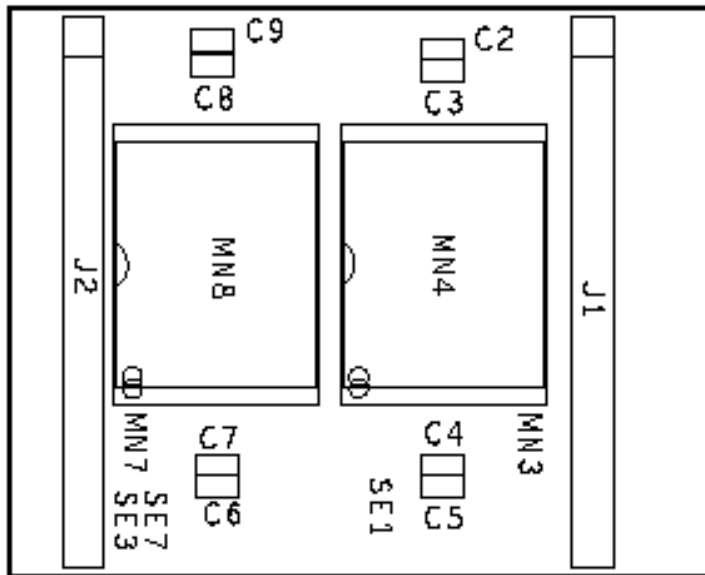


Figure 4-3. Solder Side





Atmel Corporation

2325 Orchard Parkway
San Jose, CA 95131
Tel: 1(408) 441-0311
Fax: 1(408) 487-2600

Regional Headquarters

Europe

Atmel Sarl
Route des Arsenaux 41
Case Postale 80
CH-1705 Fribourg
Switzerland
Tel: (41) 26-426-5555
Fax: (41) 26-426-5500

Asia

Room 1219
Chinachem Golden Plaza
77 Mody Road Tsimshatsui
East Kowloon
Hong Kong
Tel: (852) 2721-9778
Fax: (852) 2722-1369

Japan

9F, Tonetsu Shinkawa Bldg.
1-24-8 Shinkawa
Chuo-ku, Tokyo 104-0033
Japan
Tel: (81) 3-3523-3551
Fax: (81) 3-3523-7581

Atmel Operations

Memory

2325 Orchard Parkway
San Jose, CA 95131
Tel: 1(408) 441-0311
Fax: 1(408) 436-4314

Microcontrollers

2325 Orchard Parkway
San Jose, CA 95131
Tel: 1(408) 441-0311
Fax: 1(408) 436-4314

La Chantrerie
BP 70602
44306 Nantes Cedex 3, France
Tel: (33) 2-40-18-18-18
Fax: (33) 2-40-18-19-60

ASIC/ASSP/Smart Cards

Zone Industrielle
13106 Rousset Cedex, France
Tel: (33) 4-42-53-60-00
Fax: (33) 4-42-53-60-01

1150 East Cheyenne Mtn. Blvd.
Colorado Springs, CO 80906
Tel: 1(719) 576-3300
Fax: 1(719) 540-1759

Scottish Enterprise Technology Park
Maxwell Building
East Kilbride G75 0QR, Scotland
Tel: (44) 1355-803-000
Fax: (44) 1355-242-743

RF/Automotive

Theresienstrasse 2
Postfach 3535
74025 Heilbronn, Germany
Tel: (49) 71-31-67-0
Fax: (49) 71-31-67-2340

1150 East Cheyenne Mtn. Blvd.
Colorado Springs, CO 80906
Tel: 1(719) 576-3300
Fax: 1(719) 540-1759

Biometrics/Imaging/Hi-Rel MPU/ High Speed Converters/RF Datacom

Avenue de Rochepleine
BP 123
38521 Saint-Egreve Cedex, France
Tel: (33) 4-76-58-30-00
Fax: (33) 4-76-58-34-80

e-mail

literature@atmel.com

Web Site

<http://www.atmel.com>

Disclaimer: The information in this document is provided in connection with Atmel products. No license, express or implied, by estoppel or otherwise, to any intellectual property right is granted by this document or in connection with the sale of Atmel products. **EXCEPT AS SET FORTH IN ATMEL'S TERMS AND CONDITIONS OF SALE LOCATED ON ATMEL'S WEB SITE, ATMEL ASSUMES NO LIABILITY WHATSOEVER AND DISCLAIMS ANY EXPRESS, IMPLIED OR STATUTORY WARRANTY RELATING TO ITS PRODUCTS INCLUDING, BUT NOT LIMITED TO, THE IMPLIED WARRANTY OF MERCHANTABILITY, FITNESS FOR A PARTICULAR PURPOSE, OR NON-INFRINGEMENT. IN NO EVENT SHALL ATMEL BE LIABLE FOR ANY DIRECT, INDIRECT, CONSEQUENTIAL, PUNITIVE, SPECIAL OR INCIDENTAL DAMAGES (INCLUDING, WITHOUT LIMITATION, DAMAGES FOR LOSS OF PROFITS, BUSINESS INTERRUPTION, OR LOSS OF INFORMATION) ARISING OUT OF THE USE OR INABILITY TO USE THIS DOCUMENT, EVEN IF ATMEL HAS BEEN ADVISED OF THE POSSIBILITY OF SUCH DAMAGES.** Atmel makes no representations or warranties with respect to the accuracy or completeness of the contents of this document and reserves the right to make changes to specifications and product descriptions at any time without notice. Atmel does not make any commitment to update the information contained herein. Unless specifically provided otherwise, Atmel products are not suitable for, and shall not be used in, automotive applications. Atmel's products are not intended, authorized, or warranted for use as components in applications intended to support or sustain life.

© Atmel Corporation 2005. All rights reserved. Atmel®, logo and combinations thereof, are registered trademarks, and Everywhere You Are® are the trademarks of Atmel Corporation or its subsidiaries. Other terms and product names may be trademarks of others.



Printed on recycled paper.