

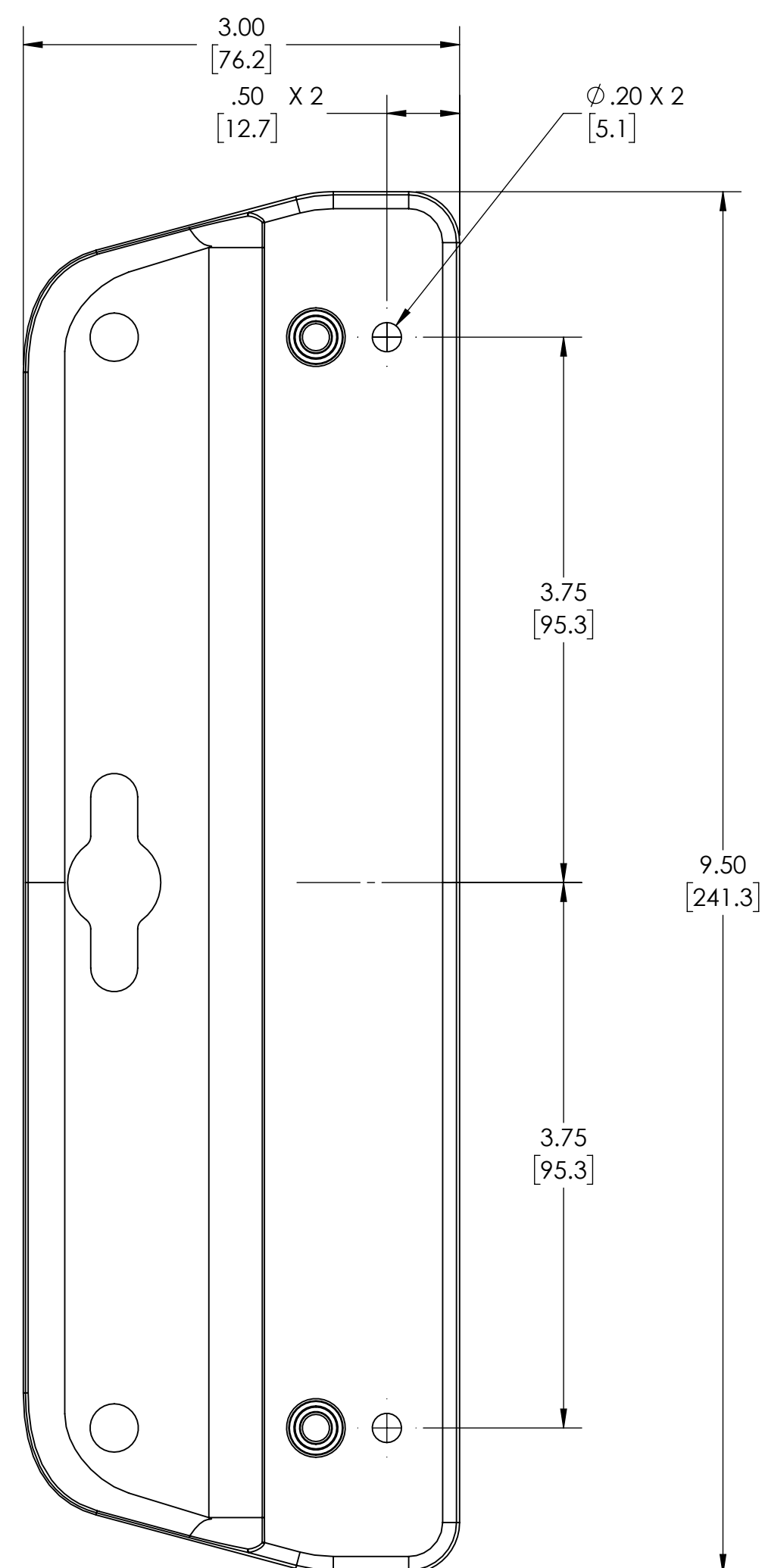

NOTES:

- 1. MATERIAL: POLYCARBONATE.
- 2. QTY PER KIT - 2
- 3. FITS: DPH-28714 & DPS-28714
- 4. SUPPLIED WITH DPX-103275X (X 4#10-32 X 3/4" LONG, PAN HEAD, EACH PHILLIPS, SS FOR DPH/S SERIES)

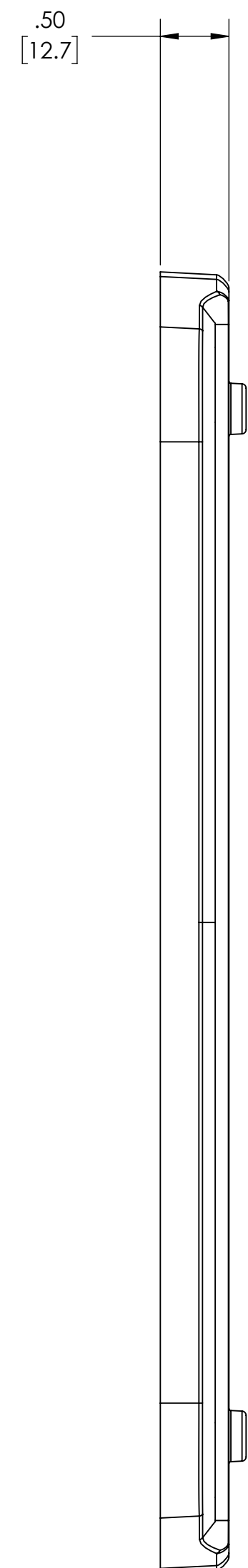
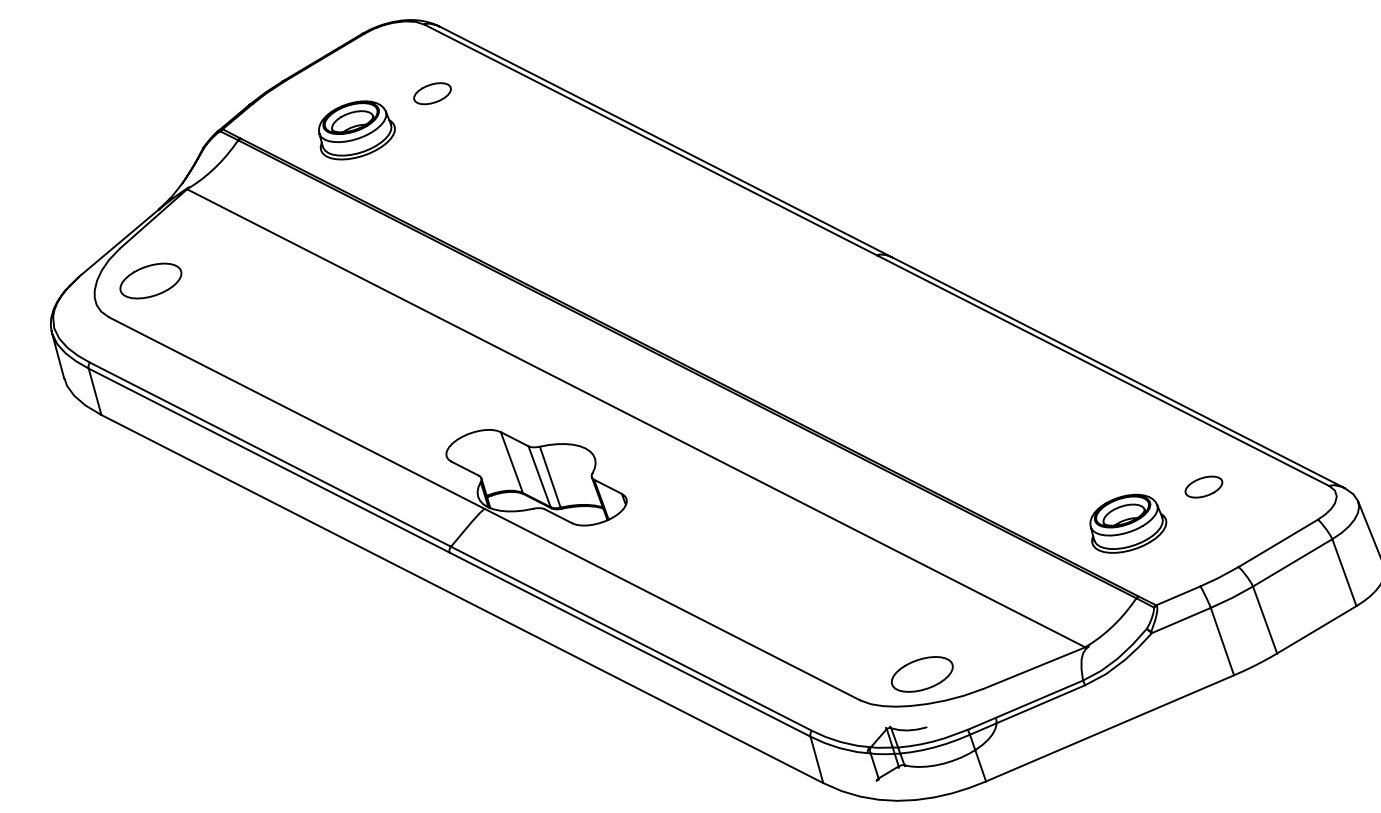

DRAWING FOR REFERENCE

WE RESERVE THE RIGHT TO MAKE CHANGES TO OUR STANDARD PRODUCTS. PLEASE CONSULT WITH BUD INDUSTRIES PRIOR TO USING THIS DRAWING FOR DESIGN PURPOSE.