

THIS DRAWING IS UNPUBLISHED. RELEASED FOR PUBLICATION
 © COPYRIGHT - By - ALL RIGHTS RESERVED.

LOC		DIST		REVISIONS					
FT		O		P	LTR	DATE	DWN	APVD	
				P		REVISED PER ECO-13-011850	13NOV2013	KH	MB

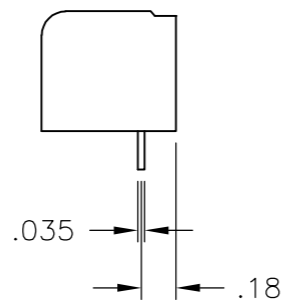
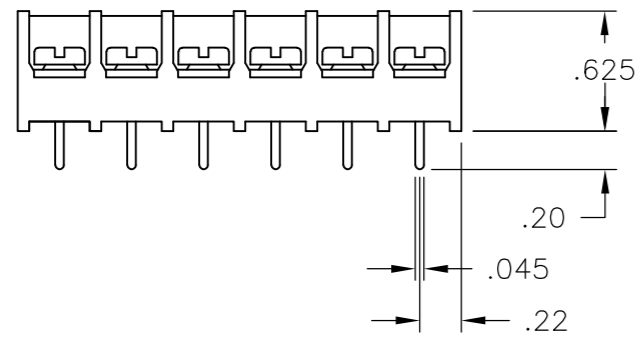
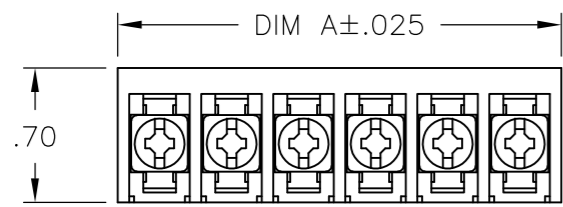

DETAIL FOR P/N's 1-1546160-6, 1-1546160-7 AND 1-1546160-8

- 1 CAPTIVE SCREWS.
- 2 MARK WITH WHITE PERMANENT INK.
- 3 ALL SCREWS TO BE DRIVEN DOWN TO TERMINAL SURFACE.
- 4 NICKEL PLATED BRASS SCREWS.
- 5 PRELIMINARY PART NUMBER.
- 6 OBSOLETE PARTS: OBSOLETE CIS STREAMLINING PER D.RENAUD/D.SINISI

SEE FIGURE
 SEE FIGURE
 SEE FIGURE
 SEE FIGURE

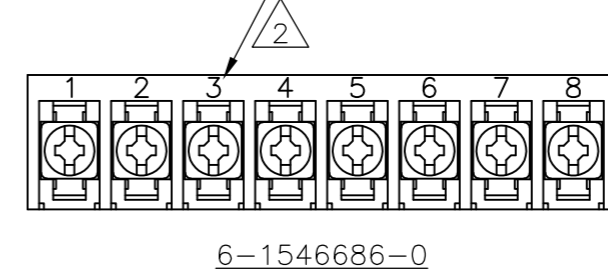
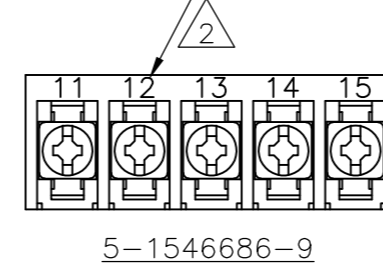
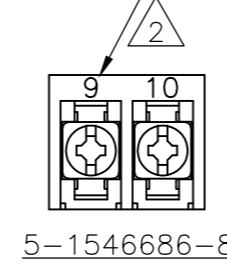
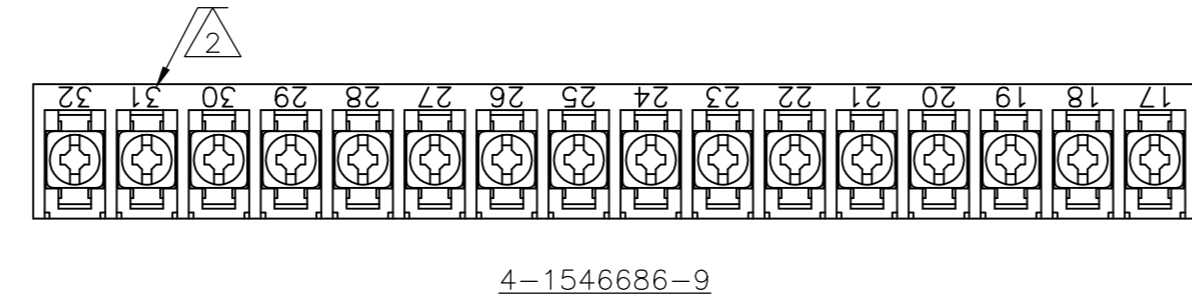
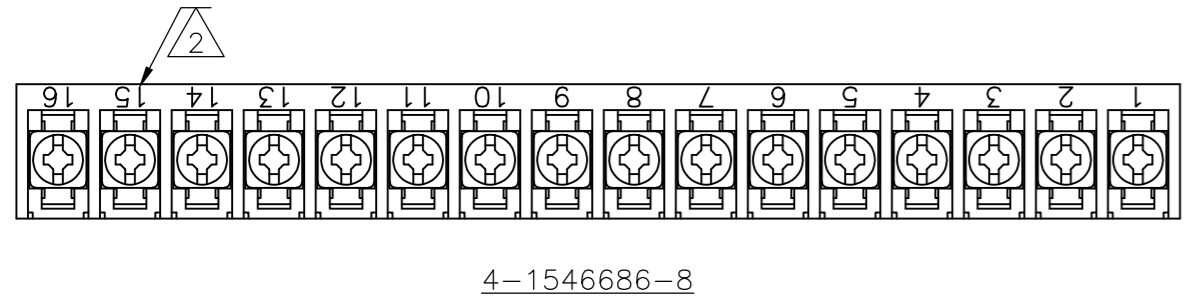
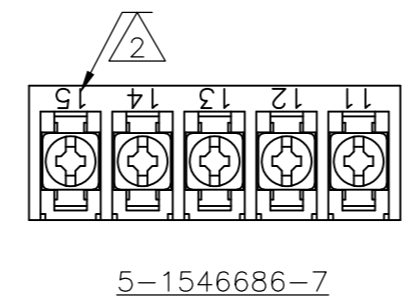
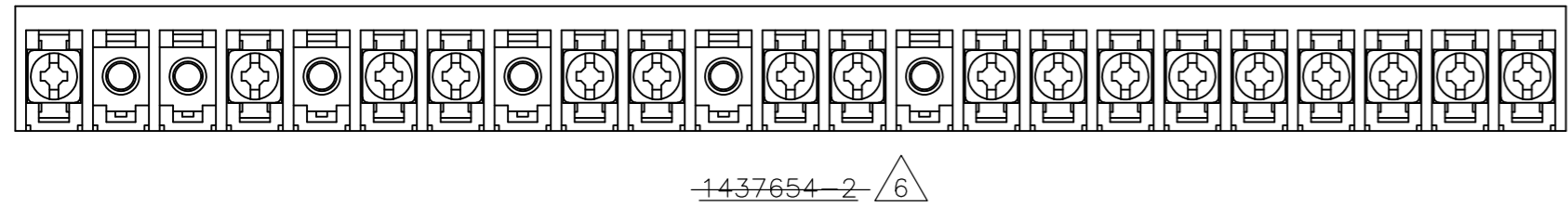
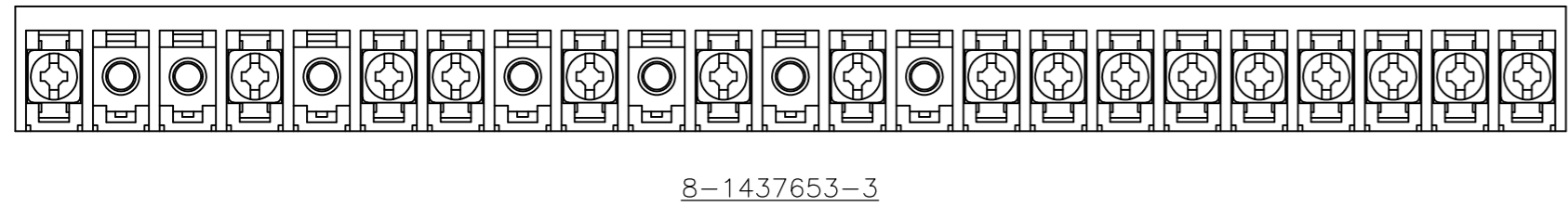
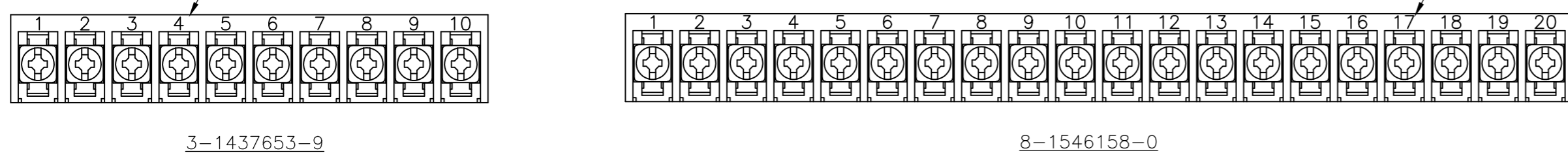
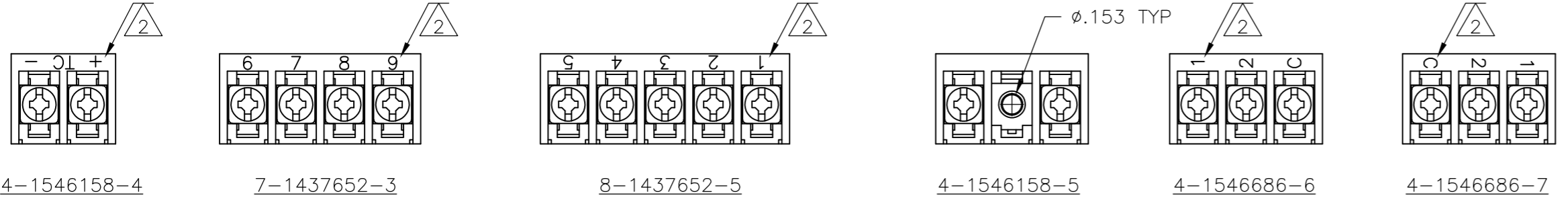

MATERIAL:
 HOUSING: THERMOPLASTIC, UL94V-0 BLACK.
 TERMINALS: BRIGHT TIN PLATED, COPPER ALLOY.
 SCREWS: 6-32, STEEL, ZINC PLATED WITH CLEAR CHROMATE.

ELECTRICAL:
 CURRENT RATING UL/CSA:
 CLASS C: 25A, 300V.
 CLASS D: 5A, 600V.
 WIRE RANGE: 12-22 AWG

MECHANICAL:
 RECOMMENDED TIGHTENING TORQUE: 7 IN-LBS.
 OPERATING TEMP.: 105°C MAX

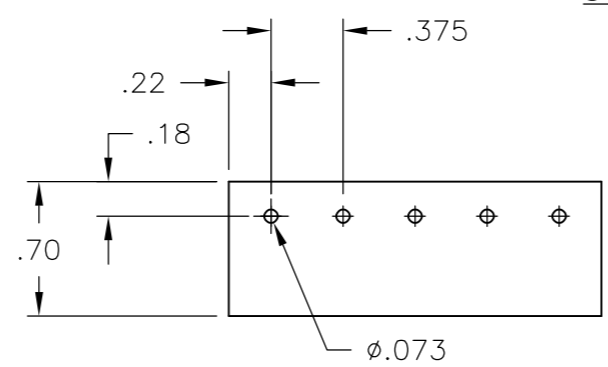

REV	DATE	DESCRIPTION	DATE	DWN	APVD
11.311	30	6PCV-30-006	4-1546686-5		
10.936	29	6PCV-29-006	1-1437656-2		
10.561	28	6PCV-28-006	8-1546158-6		
10.186	27	6PCV-27-006	8-1546158-5		
9.811	26	6PCV-26-006	4-1437654-5		
9.436	25	6PCV-25-006	4-1437654-1		
9.061	24	6PCV-24-006	8-1546158-2		
8.686	23	6PCV-23-006	4-1546686-3		
8.311	22	6PCV-22-006	3-1437654-4		
7.936	21	6PCV-21-006	3-1437654-1		
7.561	20	6PCV-20-323	8-1546158-0		
7.561	20	6PCV-20-006	1-1437654-9		
7.186	19	6PCV-19-006	1-1437654-4		
6.811	18	6PCV-18-006	1437654-7		
6.866	17	6PCV-17-899	1437654-2		
6.436	17	6PCV-17-006	9-1437653-8		
6.061	16	6PCV-16-1389	4-1546686-9		
6.061	16	6PCV-16-1388	4-1546686-8		
6.061	16	6PCV-16-1047	8-1437653-3		
6.061	16	6PCV-16-006	8-1437653-0		
5.686	15	6PCV-15-1298	1-1546160-8		
5.686	15	6PCV-15-006	7-1437653-4		
5.311	14	6PCV-14-006	6-1437653-8		
4.936	13	6PCV-13-1297	1-1546160-7		
4.936	13	6PCV-13-006	6-1437653-3		
4.561	12	6PCV-12-1296	1-1546160-6		
4.561	12	6PCV-12-006	5-1437653-1		
4.186	11	6PCV-11-006	4-1437653-5		
3.811	10	6PCV-10-1269	3-1437653-9		
3.811	10	6PCV-10-006	3-1437653-5		
3.436	9	6PCV-09-002	1546262-3		
3.436	9	6PCV-09-006	2-1437653-5		
3.061	8	6PCV-08-1394	1546262-7		
3.061	8	6PCV-08-1314	1-1437653-7		
3.061	8	6PCV-08-006	1-1437653-3		
2.686	7	6PCV-07-1399	1546262-9		
2.686	7	6PCV-07-006	1437653-7		
2.311	6	6PCV-06-1398	1546262-8		
2.311	6	6PCV-06-002	1546262-4		
2.311	6	6PCV-06-006	9-1437652-5		
1.936	5	6PCV-05-002	5-1546686-0		
1.936	5	6PCV-05-1267	8-1437652-5		
1.936	5	6PCV-05-006	8-1437652-2		
1.561	4	6PCV-04-1268	7-1437652-3		
1.561	4	6PCV-04-1143	7-1437652-2		
1.561	4	6PCV-04-006	6-1437652-7		
1.186	3	6PCV-03-1385	4-1546686-7		
1.186	3	6PCV-03-1384	4-1546686-6		
1.186	3	6PCV-03-006	5-1437652-4		
.811	2	6PCV-02-1393	1546262-6		
1.186	2	6PCV-02-807	4-1546158-5		
.811	2	6PCV-02-1313	4-1437652-5		
.811	2	6PCV-02-1216	4-1546158-4		
.811	2	6PCV-02-006	3-1437652-9		

THIS DRAWING IS A CONTROLLED DOCUMENT.		DWN	R BROWN	22APR03
DIMENSIONS: INCHES		CHK	H WAKEEM	22APR03
TOLERANCES UNLESS OTHERWISE SPECIFIED:		APVD	H WAKEEM	22APR03
0 PLC	± -	NAME		
1 PLC	± -	6PCV-XX-006		
2 PLC	± .02	SIZE	A2	CAGE CODE
3 PLC	± .010	DRAWING NO	00779	
4 PLC	± -	RESTRICTED TO	-	
ANGLES	± 1°	SCALE	1:1	
MATERIAL	FINISH	WEIGHT	-	
-		CUSTOMER DRAWING	SHEET	1 of 2
-		REV	P	

THIS DRAWING IS UNPUBLISHED. RELEASED FOR PUBLICATION
 © COPYRIGHT - By - ALL RIGHTS RESERVED.

LOC	DIST	REVISIONS					
FT	0	P	LTR	DESCRIPTION	DATE	DWN	APVD
		-		SEE SHEET 1	-	-	-

DIM A REF	NO OF POS	CATALOG NUMBER	PART NUMBER
3.061	8	6PCV-08-2006	6-1546686-0
1.936	5	6PCV-05-2006	5-1546686-9
.811	2	6PCV-02-2006	5-1546686-8
1.936	5	6PCV-05-006	5-1546686-7
1.186	3	6PCV-03-006-1	5-1546686-6

SEE FIGURE 1



THIS DRAWING IS A CONTROLLED DOCUMENT.		DWN	R BROWN	22APR03																		
DIMENSIONS: INCHES		CHK	H WAKEEM	22APR03																		
TOLERANCES UNLESS OTHERWISE SPECIFIED:		APVD	H WAKEEM	22APR03																		
<table border="0"> <tr><td>0 PLC</td><td>±</td><td>-</td></tr> <tr><td>1 PLC</td><td>±</td><td>-</td></tr> <tr><td>2 PLC</td><td>±</td><td>.02</td></tr> <tr><td>3 PLC</td><td>±</td><td>.010</td></tr> <tr><td>4 PLC</td><td>±</td><td>-</td></tr> <tr><td>ANGLES</td><td>±</td><td>1°</td></tr> </table>		0 PLC	±	-		1 PLC	±	-	2 PLC	±	.02	3 PLC	±	.010	4 PLC	±	-	ANGLES	±	1°	PRODUCT SPEC	NAME
0 PLC	±	-																				
1 PLC	±	-																				
2 PLC	±	.02																				
3 PLC	±	.010																				
4 PLC	±	-																				
ANGLES	±	1°																				
MATERIAL		APPLICATION SPEC	6PCV-XX-006																			
FINISH		WEIGHT	SIZE	CAGE CODE	DRAWING NO																	
-		-	A2	00779	C=3-1437652-9																	
CUSTOMER DRAWING			SCALE	SHEET	REV																	
			1:1	2 of 2	P																	

3-1437652-9