



# PRM Series™

## Panel Rack Mount Power Connectors

Available in 2 position



Amphenol Sine Systems' **PRM Series™ (Panel Rack Mount) Connectors**, available in both Plugs and Receptacles, are a quick-connect power connector solution for use in panel rack mount network applications. **Our quick-connect design enables denser installations, faster deployments and upgrades.**

**Quick-Connect Design**  
Simple Plug & Play  
Stackable Footprint  
Optimal Wire Management



Vs.



**Ring Terminal Design**  
Multi-Step Install Process  
Time Consuming  
Non-Optimal Wire Management

**Market Applications:** Telecommunications Infrastructure, Data Centers, Broadband

### Features & Benefits

- Field Installable w Standard Crimpers
- Stackable / Reduced Footprint / In-Line Wire Design
- Faster Installations / Replacements
- Keyed to prevent mis-mating/reverse polarity
- RADSOK®\* and SureSocket™ Contacts
- Panel receptacles can be customized to your specific application

### Technical Specifications

Operating Temperature	-40°C to +125°C
Current (Amperage)	Up to 70A
Maximum Voltage	250V
Minimum Mating Cycles	>500
Contact Sizes	2.4mm: 0.216 (5.5mm); 4.0mm: 0.315 (8mm)
Number/Size of Contacts	2/ 2.4mm (SureSocket™) or 4.0mm (RADSOK®)
Contacts	SureSocket™ Spring: Copper Alloy, Gold-Plated RADSOK® Spring: Copper Alloy, Silver-Plated
Contact Barrel Range	2.4mm: 10-20AWG; 4.0mm: 6-16AWG
Housing Body	GF PA 6/6
Flame Rating	UL94 V-0



\*RADSOK Male 4.0mm are Touch-Proof for added safety



Standard products. Custom solutions  
Customer Service +1 800 394 7732

PRM Series™, 2.4mm

Image	Part Number	Description	Size	Amp	Voltage
	PRM2400-G2-PLG	Kit, 2 Position, Female Plug, Socket, PRM Series™, 10-12AWG SureSocket™ Machined Contacts Mates with: PRM2400-G2-PNL	2.4mm	Up to 32A	250
	PRM2400-G3-PLG	Kit, 2 Position, Female Plug, Socket, PRM Series™, 14-16AWG SureSocket™ Machined Contacts Mates with: PRM2400-G2-PNL	2.4mm	Up to 20A	250
	PRM2400-G4-PLG	Kit, 2 Position, Female Plug, Socket, PRM Series™, 18-20AWG SureSocket™ Machined Contacts Mates with: PRM2400-G2-PNL	2.4mm	Up to 12A	250
	PRM2400-G2-PNL	Kit, 2 Position, Male Receptacle, Pin, PRM Series™, 12-14AWG Machined Contacts Mates with: PRM2400-GX-PLG	2.4mm	Up to 32A	250
	PL000733	2.4mm, Male Receptacle Housing, PRM Series™	2.4mm	N/A	N/A
	PL000734	2.4mm, Female Plug Housing for use with PL000735, PRM Series™	2.4mm	N/A	N/A
	PL000735	2.4mm, Retainer Clip for use with PL000734, PRM Series™	2.4mm	N/A	N/A
	SC000565	2.4mm, Contact, Pin, 4-40 UNC Thread	2.4mm	30A Max	N/A
	SC000611	2.4mm, Contact, Pin, 10-12AWG	2.4mm	30A Max	N/A
	SC000612	2.4mm, Female SureSocket™ Machined Contact, 10-12AWG	2.4mm	30A Max	N/A
	SC000692	2.4mm, Female SureSocket™ Machined Contact, 14-16AWG	2.4mm	20A Max	N/A
	SC000706	2.4mm, Female SureSocket™ Machined Contact, 18-20AWG	2.4mm	10A Max	N/A

PRM Series™, 4.0mm

Image	Part Number	Description	Size	Amp	Voltage
	PRM0400-G1-PLG	Kit, 2 Position, Female Plug, Socket, PRM Series™, 14-16AWG Machined RADSOK® R8S Contacts, Retainer Clip Mates with: PRM0400-G1-PNL	4.0mm	Up to 43A	250
	PRM0400-G2-PLG	Kit, 2 Position, Female Plug, Socket, PRM Series™, 10-12AWG Machined RADSOK® R8S Contacts, Retainer Clip Mates with: PRM0400-G3-PNL	4.0mm	Up to 43A	250
	PRM0400-G4-PLG	Kit, 2 Position, Female Plug, Socket, PRM Series™, 6-8AWG Machined RADSOK® R8S Contacts, Retainer Clip Mates with: PRM0400-G2-PNL	4.0mm	70A Max	250
	PRM0400-G3-PNL	Kit, 2 Position, Male Receptacle, Pin, PRM Series™, 1 X 8AWG Machined Contact and 1 X 8-32 Threaded Bus Bar Contact Mates with: PRM0400-GX-PLG	4.0mm	70A Max	250
	PL000727	4.0mm, Male Receptacle, Panel Side Contact Housing, PRM Series™	4.0mm	70A Max	N/A
	PL000728	4.0mm, Female Plug Housing for use with PL000729, PRM Series™	4.0mm	N/A	N/A
	PL000729	4.0mm, Contact Retainer Clip for use with PL000728, PRM Series™	4.0mm	N/A	N/A
	SC000530	4.0mm Male Pin, 8-32 UNC Thread used with PL000727	4.0mm	70A Max	N/A
	SC000531-8	4.0mm, Male Pin, 8-10AWG	4.0mm	70A Max	N/A
	SC000532-6-R4	4.0mm Female Socket, 6-8AWG Machined RADSOK® R8S Contact	4.0mm	70A Max	N/A
	SC000532-10-R4	4.0mm Female Socket, 10-12AWG Machined RADSOK® R8S Contact	4.0mm	70A Max	N/A
	SC000532-14-R4	4.0mm Female Socket, 14-16AWG Machined RADSOK® R8S Contact	4.0mm	70A Max	N/A
	50-80639	4.0mm, Extraction Tool	4.0mm	N/A	N/A

PRM Series™ 2.4mm Plug Dimensions

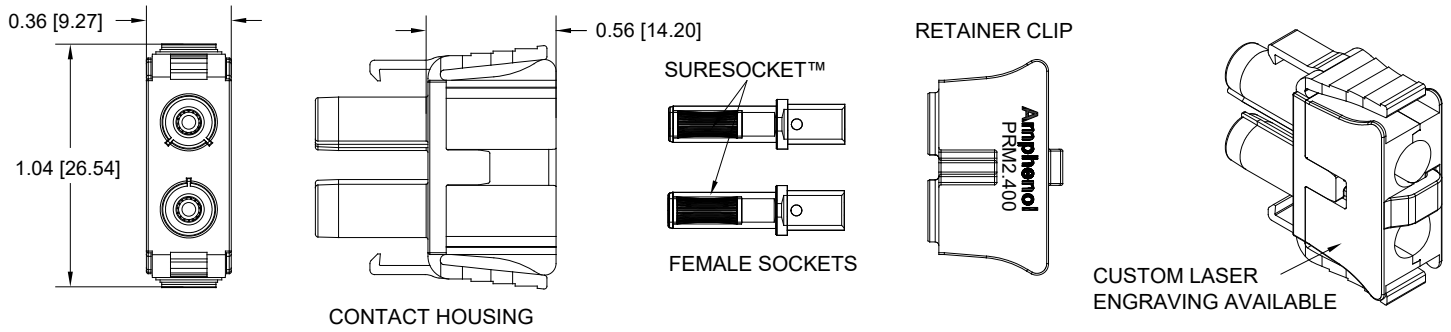

PRM Series™ 2.4mm Panel Dimensions

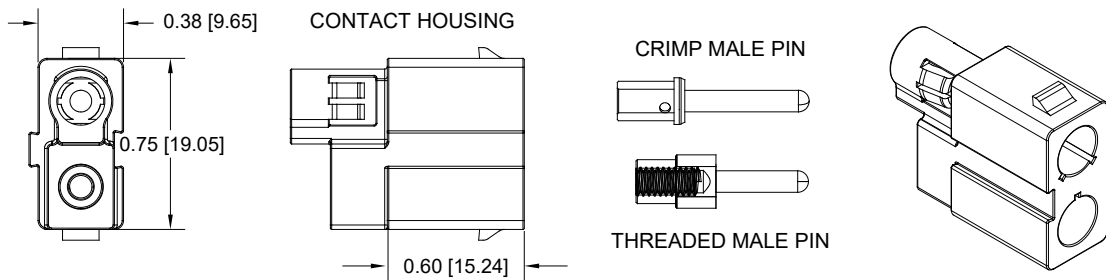

PRM Series™ 4.0mm Plug Dimensions

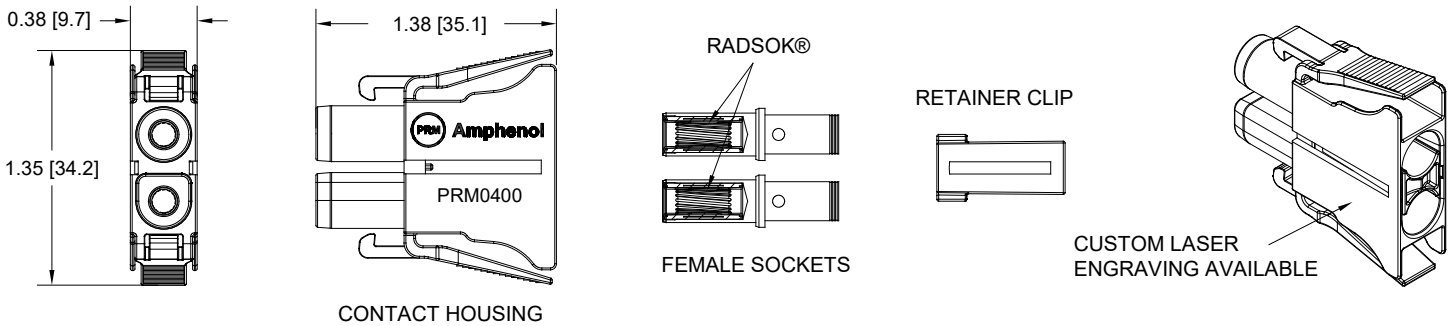

PRM Series™ 4.0mm Panel Dimensions

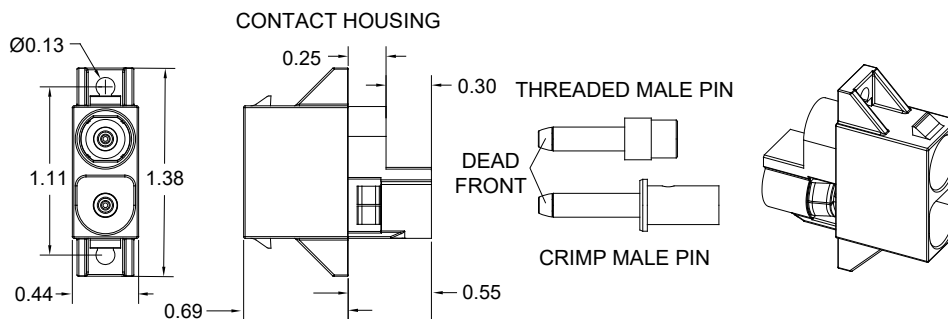



## Confidence In Every Connection

The unique design of our **SureSocket™ Contacts**, available in 2.4mm with a wire range of 10-20AWG, provides a **secure 360° of mating surface area** to its mated machined pin. This distributes even forces over a high percentage of the mating surface, creating a smooth, even engagement effort with low insertion and extraction forces as well as low contact resistance. This also contributes to excellent performance in vibration applications with resistance to typical fretting corrosion.

### Key Features

- Longer contact life
- Low contact resistance
- Low insertion & extraction forces
- Increased immunity to shock & vibration
- Contact Area Extends 360° Around Pins
- Higher amperage in a compact design

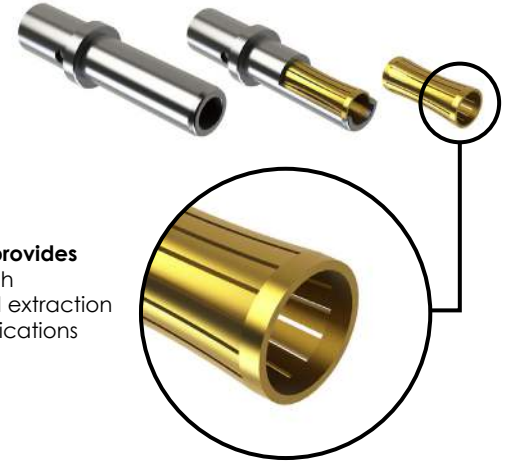

### Technical Specifications

Operating Temperature	-40°C to +125°C
Contact Body	Copper Alloy, Silver-Plated
Contact Spring	Copper Alloy, Gold Flash
Max. Current (AMP)	Socket #SC000612 / 35A / 10-12AWG Socket #SC000624 / 25A / 12-14AWG Socket #SC000692 / 16A / 14-16AWG Socket #SC000706 / 12A / 18-20AWG
Termination Type	Crimp
Mating Cycles	<500 matings and unmatings
RoHS	Compliant

### Derating Curves - IEC 60512-5-2 Test 5b

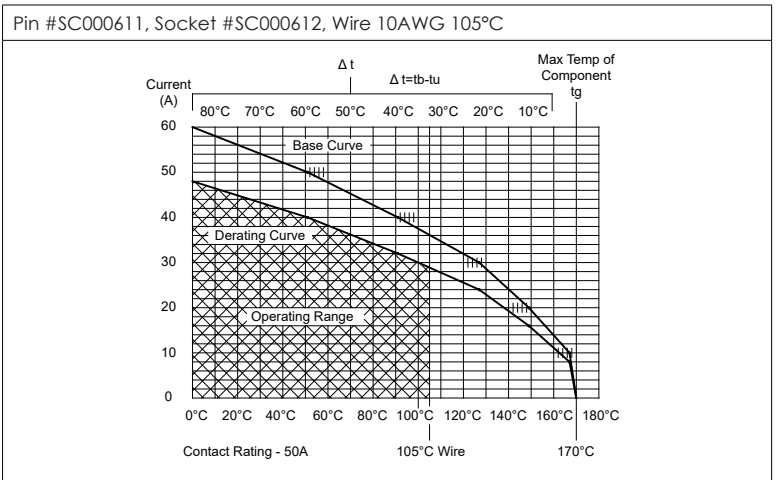

Socket #SC000612 Dimensions

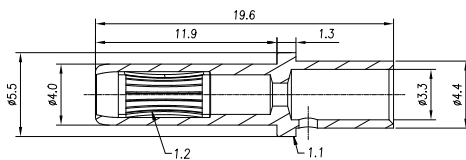

Socket #SC000624 Dimensions

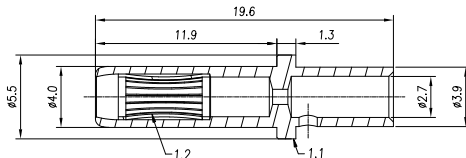

Socket #SC000692 Dimensions

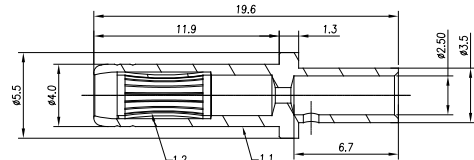

Socket #SC000706 Dimensions

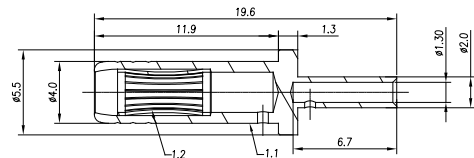



# R RADSOK® R8S

## High Voltage, High Current Contact System

The RADSOK® R8S is a further development of the extremely reliable RADSOK® contact system, which has been successfully used in industrial sectors for a number of decades. The symmetrical annular contact, which has been optimized in all areas, is comprised of a contact grid made of a beryllium-free copper alloy and features a radially-twisted lamella layout for self-cleaning. This design enables the contacts to achieve the best possible contact resistance and high corrosion resistance. The RADSOK® R8S contact system withstands temperatures up to 170°C. The new and improved contact system also boasts a high power density in proportion to its weight.

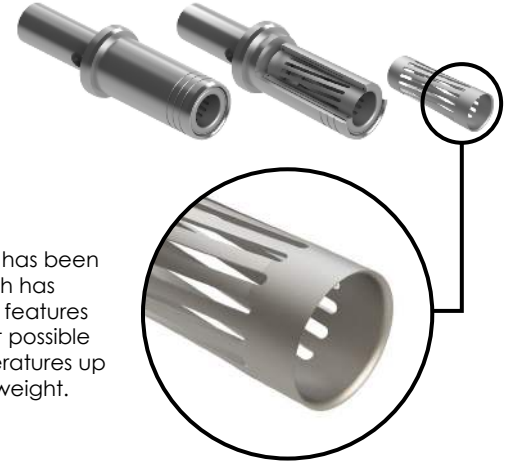

**Applications:** Industrial, Automation, Harsh Environment

### Key Features

- Low contact resistance
- Higher amperage in a compact design
- Contact Area Extends 360° Around Pins
- Radially-twisted lamella layout for self-cleaning
- Withstands temperatures up to 170°C

### Technical Specifications

Operating Temperature	-40°C to +170°C
Contact Body	Copper Alloy, Silver-Plated
Contact Spring	Copper Alloy, Silver-Plated
Max. Current (AMP)	Socket #SC000532-6-R4 / 70A / 6-8AWG Socket #SC000532-10-R4 / 70A / 10-12AWG Socket #SC000532-14-R4 / 70A / 14-16AWG
Termination Type	Crimp
Mating Cycles	>500 matings and unmatings
RoHS	Compliant

### Derating Curves - DIN EN 60512-5-2:2003-01

Pin #SC000531-8, Socket #SC000532-10-R4, Wire 10AWG

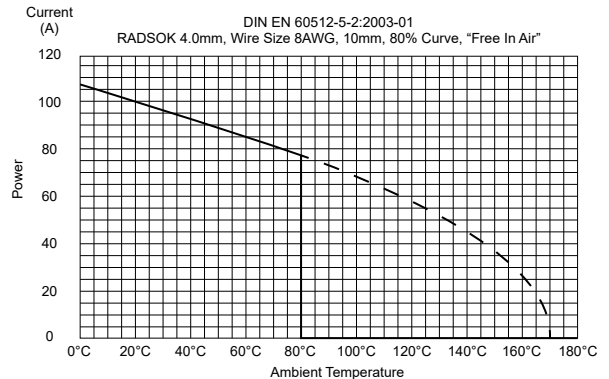

Socket #SC000532-6-R4 Dimensions

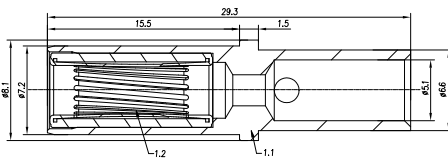

Socket #SC000532-10-R4 Dimensions

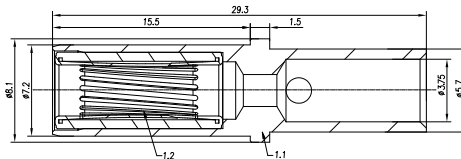

Socket #SC000532-14-R4 Dimensions

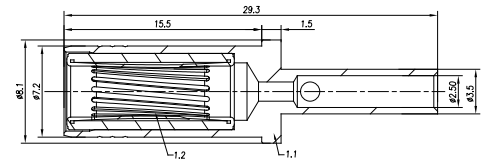

**For more information, contact:** Customer Service, +1 800 394 7732, [csr@amphenol-sine.com](mailto:csr@amphenol-sine.com)

© 2020 Amphenol Sine Systems Corporation, 44274 Morley Drive, Clinton Township MI 48036 USA. [www.amphenol-sine.com](http://www.amphenol-sine.com). Customer Service +1 800 394 7732 Every effort has been made to ensure that the information contained in this document is accurate at the time of publication. Specifications or information stated in this document are subject to change without notice. 10/2020