

AS SHOWN: TYPE-1

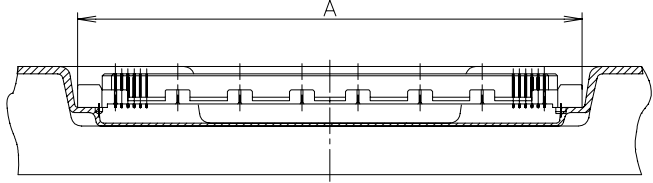

REVISIONS				
変更				
P	LTR	DESCRIPTION	DATE	APVD
	D	ECO-20-017853: G-CONTACT TAIL GOLD FLASH	18DEC2020	A.L H.L
	C	REVISED PER ECO-17-002393	27MAY17	B.J S.Y

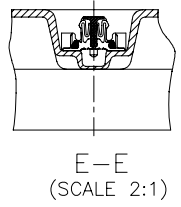
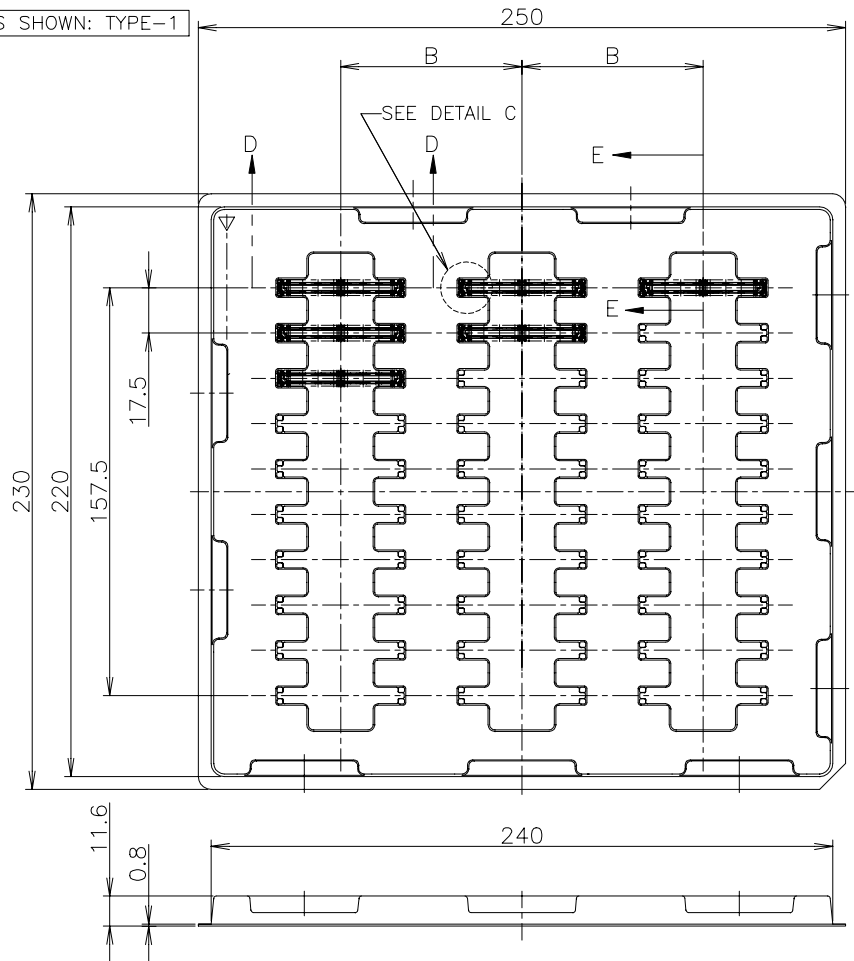
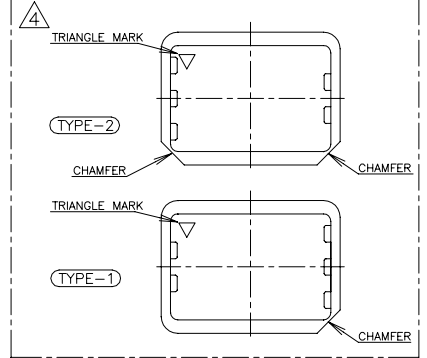

SEALANT	TOOLING STATUS	ROW	QTY	B	A	POS.	TRAY P/N	PART NO.
AVAILABLE		3	30	70	54.7	160	912063-9	6-5316077-1
AVAILABLE					48.7	140	912063-8	6- - -0
NOT AVAILABLE					42.7	120	4-912065-9	5- - -9
NOT AVAILABLE					36.7	100	8-912066-2	5- - -8
NOT AVAILABLE		3	30	70	33.7	90	9-912066-6	5- - -7
NOT AVAILABLE		5	50	43	30.7	80	912067-3	5- - -6
AVAILABLE					27.7	70	912063-1	5- - -5
NOT AVAILABLE					24.7	60	9-912066-5	5- - -4
AVAILABLE					21.7	50	9-912062-9	5- - -3
NOT AVAILABLE					18.7	40	9-912066-4	5- - -2
NOT AVAILABLE		5	50	43	15.7	30	9-912066-3	5-5316077-1
AVAILABLE		3	30	70	54.7	160	912063-9	1-5316077-1
AVAILABLE					48.7	140	912063-8	1- - -0
NOT AVAILABLE					42.7	120	4-912065-9	- - -9
NOT AVAILABLE					36.7	100	8-912066-2	- - -8
NOT AVAILABLE		3	30	70	33.7	90	9-912066-6	- - -7
NOT AVAILABLE		5	50	43	30.7	80	912067-3	- - -6
AVAILABLE					27.7	70	912063-1	- - -5
NOT AVAILABLE					24.7	60	9-912066-5	- - -4
AVAILABLE					21.7	50	9-912062-9	- - -3
NOT AVAILABLE					18.7	40	9-912066-4	- - -2
NOT AVAILABLE		5	50	43	15.7	30	9-912066-3	5316077-1

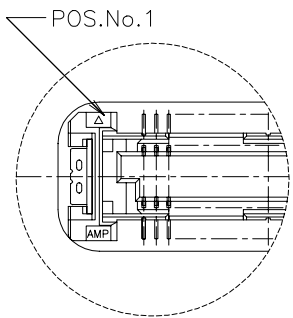

⚠ TRAY TYPE-1 AND TYPE-2 MUST BE PILED UP BY TURNS. (REFER TO PACKING SPECIFICATIONS)

GENERAL TOLERANCE
一般公差

10 ≥	±0.2
30 ≥	>10: ±0.25
100 ≥	>30: ±0.3
ANGLES: ±3°	

THIS DRAWING IS A CONTROLLED DOCUMENT.

DIMENSIONS: 單位: 耗 mm

TOLERANCES UNLESS OTHERWISE SPECIFIED: 一般公差

0 PLC ± -
1 PLC ± -
2 PLC ± -
3 PLC ± -
4 PLC ± -
ANGLES ± -

MATERIAL 材料

FINISH 仕上

TE Connectivity Ltd.

TRAY ASSY
FH 0.6BTB CONNECTOR
REC 4H W/G-CONT

SIZE A3 CAGE CODE 00779 DRAWING NO. 5316077

SCALE 1:2 SHEET 1 OF 3 REV D

CUSTOMER DRAWING

REVISIONS

P	LTR	DESCRIPTION	DATE	DWN	APVD
-	-	SEE SHEET 1	-	-	-

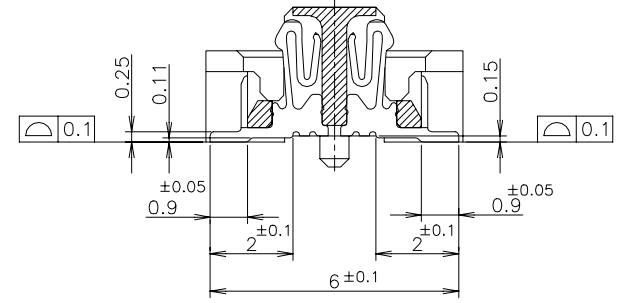
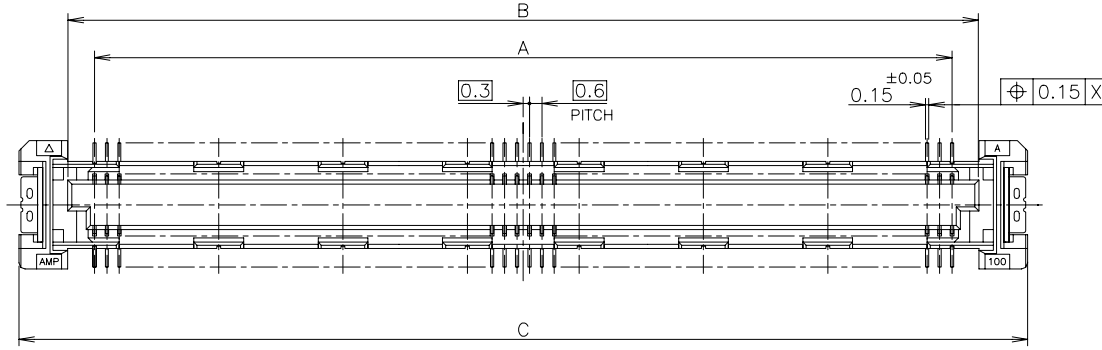

G-G
(SIGNAL POSITION)
(SCALE 8:1)

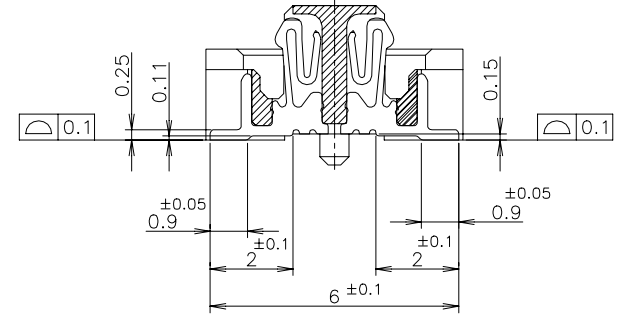
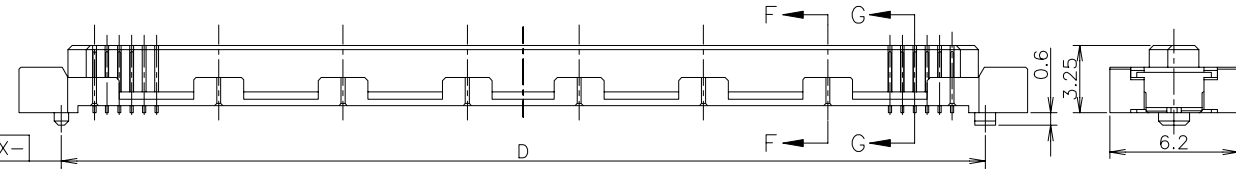

F-F
(GROUND POSITION)
(SCALE 8:1)

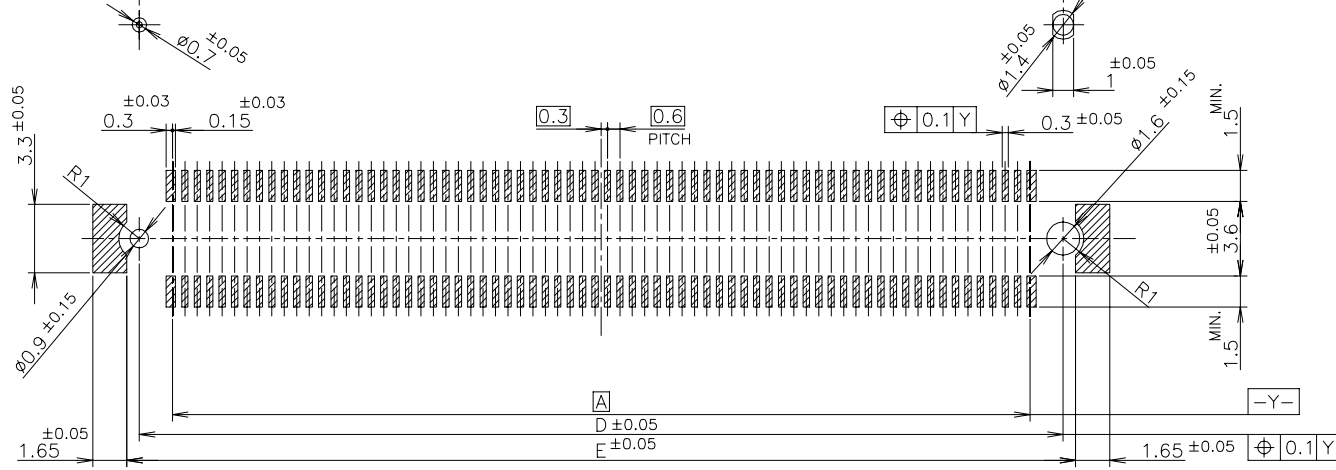

REFERENCE P.C. BOARD LAYOUT

AVAILABLE	51.8	50.6	54.7	50	47.4	160
AVAILABLE	45.8	44.6	48.7	44	41.4	140
NOT AVAILABLE	39.8	38.6	42.7	38	35.4	120
AVAILABLE	33.8	32.6	36.7	32	29.4	100
NOT AVAILABLE	30.8	29.6	33.7	29	26.4	90
AVAILABLE	27.8	26.6	30.7	26	23.4	80
	24.8	23.6	27.7	23	20.4	70
	21.8	20.6	24.7	20	17.4	60
	18.8	17.6	21.7	17	14.4	50
AVAILABLE	15.8	14.6	18.7	14	11.4	40
NOT AVAILABLE	12.8	11.6	15.7	11	8.4	30
TOOLING STATUS	E	D	C	B	A	POS

THIS DRAWING IS A CONTROLLED DOCUMENT.

DIMENSIONS: 單位: 耗 mm	TOLERANCES UNLESS OTHERWISE SPECIFIED: 一般公差	DWN	TE Connectivity Ltd.
	0 PLC ± 0.3 1 PLC ± 0.3 2 PLC ± 0.3 3 PLC ± 0.3 4 PLC ± 0.3 ANGLES ± 3°	CHK	
MATERIAL 材料	FINISH 仕上	APVD	
		PRODUCT SPEC 製品規格	
		APPLICATION SPEC 取付適用規格	
		WEIGHT	NAME 名称
		CUSTOMER DRAWING	TRAY ASSY FH 0.6BTB CONNECTOR REC 4H W/G-CONT
		SCALE 尺度 4:1	SIZE CAGE CODE DRAWING NO A3 00779 G=5316077
		SHEET 2 OF 3	RESTRICTED TO
		REV D	

REVISIONS					
変更					
P	LTR	DESCRIPTION	DATE	DWN	APVD
-	-	SEE SHEET 1	-	-	-

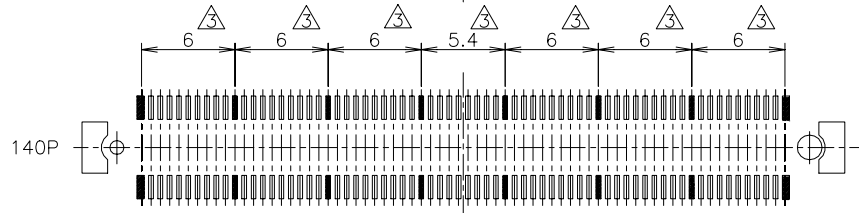
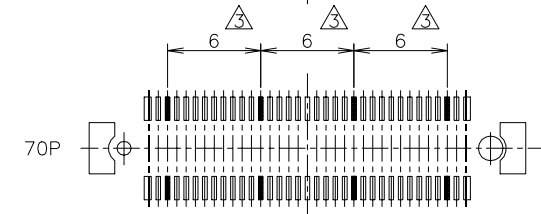
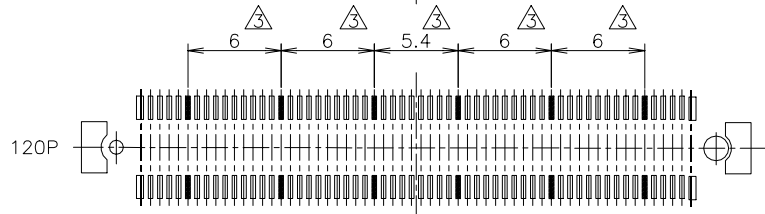
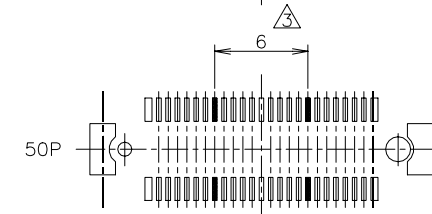
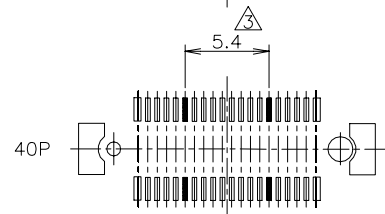
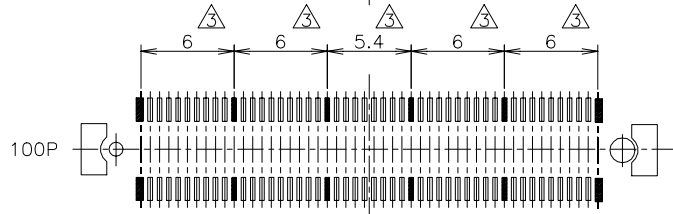
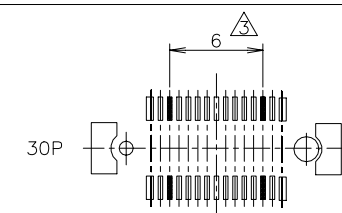
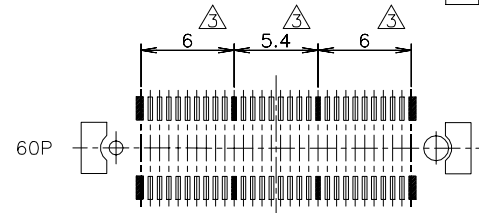
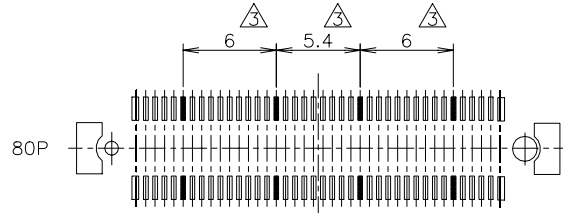

- △ MATERIAL ; HOUSING : HIGH TEMP THERMO PLASTIC
UL94V-0
- △ FINISH ; CONTACT : COPPER ALLOY
; UNDER PL Ni 0.0013mm MIN ALL OVER.
CONTACT AREA 0.0002 MIN Au PL.
SOLDERING AREA: SIGNAL POS 0.00005 MIN Au PL.
① GROUND POS 0.00005 MIN Au PL.
- △ THIS POSITION IS GROUND CIRCUIT.

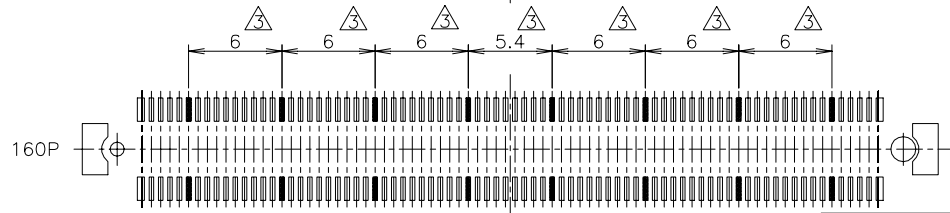

THIS DRAWING IS A CONTROLLED DOCUMENT.		DWN	TE Connectivity Ltd.	
		CHK		
DIMENSIONS: 单位: 耗 mm	TOLERANCES UNLESS OTHERWISE SPECIFIED: 一般公差	APVD	NAME 名称	
	0 PLC ± 0.3	PRODUCT SPEC 製品规格	TRAY ASSY	
	1 PLC ± 0.3	APPLICATION SPEC 取付適用规格	FH 0.6BTB CONNECTOR	
MATERIAL 材料	FINISH 仕上	WEIGHT	SIZE	CAGE CODE
	2 PLC ± 0.3		A3	00779
	3 PLC ± 0.3	CUSTOMER DRAWING	DRAWING NO 番号	RESTRICTED TO
	4 PLC ± 0.3		G=5316077	
	ANGLES ± 3'		SCALE 尺度	SHEET
			3:1	3 OF 3
				REV
				D