



Buchanan

TE Internal #: 282837-9

PCB Terminal Blocks, Header, Wire-to-Board, 9 Position, .2 in [5.08 mm] Centerline, 1 Row, 90° Wire Entry Angle, 30 – 16 AWG Wire Size

[View on TE.com >](#)

Connectors > Terminal Blocks & Strips > PCB Terminal Blocks

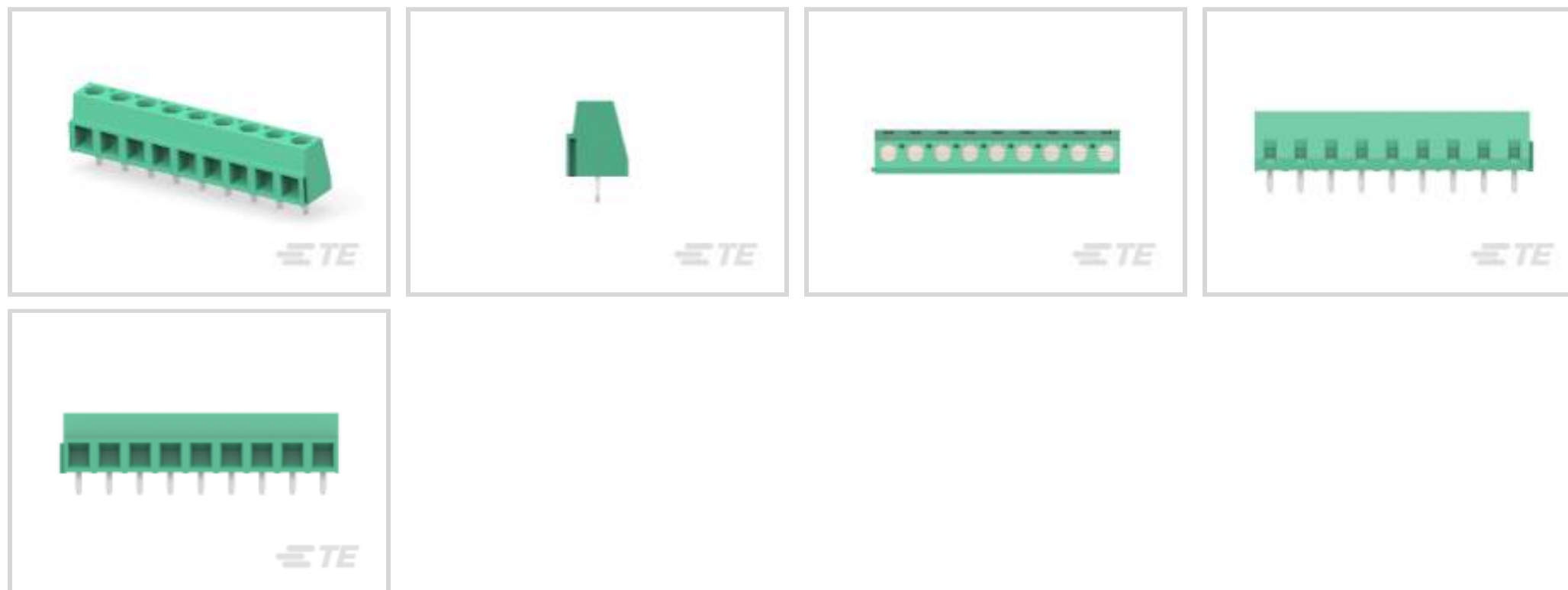

Terminal Block Connector Type: **Header**

Connector System: **Wire-to-Board**

Number of Positions: **9**

Centerline (Pitch): **5.08 mm [.2 in]**

Number of Rows: **1**

Features

Product Type Features

Wire Protection	With
Terminal Block Connector Type	Header
Connector System	Wire-to-Board
Connector & Contact Terminates To	Printed Circuit Board

Configuration Features

Stacked Levels	Without
Wire Entry Location	Side
Stacking Configuration	Side Stackable
Number of Positions	9
Number of Rows	1
Wire Entry Angle	90°

Electrical Characteristics

Operating Voltage	300 VAC
-------------------	---------

Body Features



Primary Product Color	Green
Product Orientation	Vertical

Contact Features

Contact Mating Area Plating Material	Tin
Contact Base Material	Brass
Contact Current Rating (Max)	13.5 A

Termination Features

Termination Post & Tail Length	3.5 mm[.138 in]
Termination Method to Printed Circuit Board	Through Hole - Solder

Mechanical Attachment

Screw Plating Material	Nickel
Screw Material	Brass
Thread Size	M3
Connector Mounting Type	Board Mount

Housing Features

Housing Material	PA 66
Centerline (Pitch)	5.08 mm[.2 in]

Dimensions

Wire Size	.05 – 1.3 mm ²
-----------	---------------------------

Usage Conditions

Operating Temperature Range	-40 – 110 °C[-40 – 230 °F]
-----------------------------	----------------------------

Operation/Application

Circuit Application	Power & Signal
---------------------	----------------

Packaging Features

Packaging Quantity	100
--------------------	-----

Other

Terminal Blocks & Strips Comment	10A Field Wiring
----------------------------------	------------------

Product Compliance

For compliance documentation, visit the product page on TE.com>

EU RoHS Directive 2011/65/EU	Not Compliant
------------------------------	---------------



EU ELV Directive 2000/53/EC

Compliant with Exemptions

China RoHS 2 Directive MIIT Order No 32, 2016

Restricted Materials Above Threshold

EU REACH Regulation (EC) No. 1907/2006

Current ECHA Candidate List: JUNE 2023 (235)

Candidate List Declared Against: JUNE 2022 (224)

SVHC > Threshold:

Pb (2% in Component)

Article Safe Usage Statements:

Do not eat, drink or smoke when using this product. Wash thoroughly after handling. Recycle if possible and dispose of the article by following all applicable governmental regulations relevant to your geographic location.

Halogen Content

Low Halogen - Br, Cl, F, I < 900 ppm per homogenous material. Also BFR/CFR/PVC Free

Solder Process Capability

Wave solder capable to 265°C

Product Compliance Disclaimer

This information is provided based on reasonable inquiry of our suppliers and represents our current actual knowledge based on the information they provided. This information is subject to change. The part numbers that TE has identified as EU RoHS compliant have a maximum concentration of 0.1% by weight in homogenous materials for lead, hexavalent chromium, mercury, PBB, PBDE, DBP, BBP, DEHP, DIBP, and 0.01% for cadmium, or qualify for an exemption to these limits as defined in the Annexes of Directive 2011/65/EU (RoHS2). Finished electrical and electronic equipment products will be CE marked as required by Directive 2011/65/EU. Components may not be CE marked. Additionally, the part numbers that TE has identified as EU ELV compliant have a maximum concentration of 0.1% by weight in homogenous materials for lead, hexavalent chromium, and mercury, and 0.01% for cadmium, or qualify for an exemption to these limits as defined in the Annexes of Directive 2000/53/EC (ELV). Regarding the REACH Regulation, the information TE provides on SVHC in articles for this part number is based on the latest European Chemicals Agency (ECHA) 'Guidance on requirements for substances in articles' posted at this URL: <https://echa.europa.eu/guidance-documents/guidance-on-reach>

Compatible Parts



Customers Also Bought

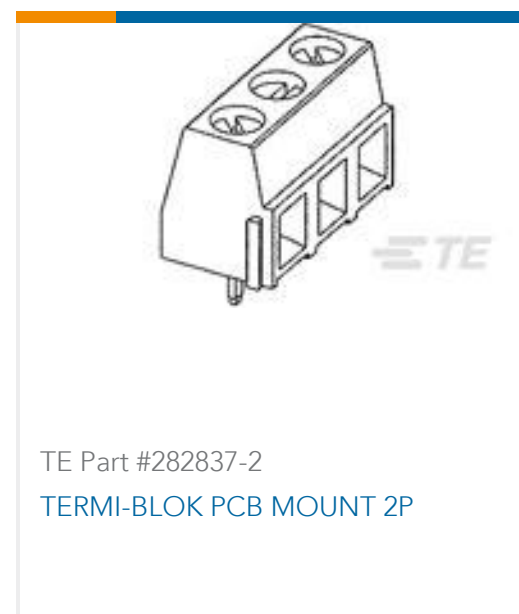

Documents

Product Drawings

[TERMI-BLOK PCB MOUNT 9P](#)

English

CAD Files

[3D PDF](#)

3D

Customer View Model

[ENG_CVM_CVM_282837-9_F.2d_dxf.zip](#)

English

Customer View Model

[ENG_CVM_CVM_282837-9_F.3d_igs.zip](#)

English

Customer View Model

[ENG_CVM_CVM_282837-9_F.3d_stp.zip](#)

English

Customer View Model

[ENG_CVM_282837-9_G2.3d_igs.zip](#)

English



Customer View Model

[ENG_CVM_282837-9_G2.3d_stp.zip](#)

English

[3D PDF](#)

3D

Customer View Model

[ENG_CVM_282837-9_G2.2d_dxf.zip](#)

English

By downloading the CAD file I accept and agree to the [Terms and Conditions](#) of use.

Datasheets & Catalog Pages

[BUCHANAN TERMINAL BLOCKS CATALOG - EUROSTYLE TERMINAL BLOCKS](#)

English

[1-1773458-1_EURO_STYLE_TERMINAL_BLOCKS_QRG](#)

English

Product Specifications

[Application Specification](#)

English

Agency Approvals

[UL](#)

English