



Sub-Miniature Toggle

Specifications

Electrical Ratings	3A @ 120VAC, 28VDC 1A @ 250VAC See Contact Options	Dielectric Resistance	1500Vrms min
Electrical Life	30,000 cycles typical	Insulation Resistance	>100MΩ min
Contact Resistance	<20mΩ initial @ 2-4VDC, 100mA	Operating Temperature	-40°C to 85°C
		Storage Temperature	-40°C to 85°C

Materials

Actuator	Brass, Chrome Plated
Housing	Dially Phthalate (DAP)
Cover	Stainless Steel
Bushing	Brass, Nickel Plated
Contacts	Copper Alloy, Silver or Gold Plated
Terminals	Brass, Silver or Gold Plated

Ordering Information

1. Series	BNT	2	1	U	E1	C	Q	E
BNT								
2. Number of Poles 1 = SPDT 2 = DPDT								
3. Switch Function 1 = ON-NONE-ON 2 = ON-NONE-(ON) 3 = ON-OFF-ON 4 = (ON)-OFF-(ON) Only in SPDT models 5 = ON-OFF-(ON) Only in SPDT models								
4. Actuator T = 5.33mm, standard on E, E1, F, F1 bushings U = 7.37mm, standard on E, E1, F, F1 bushings S = 9.40mm, standard on E, E1, F, F1 bushings X = 5.59mm, standard on G, G1, J, J1 bushings V = 10.41mm, standard on G, G1, J, J1 bushings								
5. Bushing E / E1 = 5.59mm, 10-48UNS / non-threaded, flat F / F1 = 5.59mm, 10-48UNS / non-threaded, keyway J / J1 = 6.60mm, 1/4-40NS / non-threaded, keyway G / G1 = 7.87mm, 1/4-40NS / non-threaded, flat								
6. Terminals B = Solder lug C = PC pin H = Horizontal mount, right angle PC pin; HS = Snap-in V = Vertical mount, right angle PC pin; VS = Snap-in A5 = PC pin with support bracket, A5S = Snap-in support bracket								
7. Contacts Q = Silver plated R = Gold plated G = Gold over Silver plated								
8. Epoxy Seal E = Epoxy seal								

Switch Function



SPDT



Function	Toggle Position		
1	ON	NONE	ON
2	ON	NONE	(ON)
3	ON	OFF	ON
4	(ON)	OFF	(ON)
5	ON	OFF	(ON)
Terminals	2-3	-	2-1

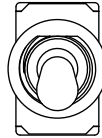

POS. 3
POS. 2
POS. 1

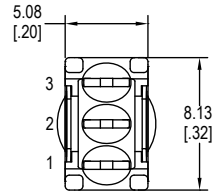
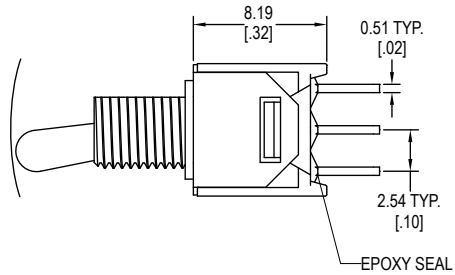

DPDT

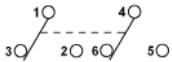

Function	Toggle Position		
1	ON	NONE	ON
2	ON	NONE	(ON)
3	ON	OFF	ON
4	(ON)	OFF	(ON)
5	ON	OFF	(ON)
Terminals	2-3	-	2-1

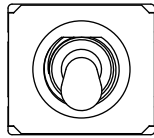

POS. 3
POS. 2
POS. 1

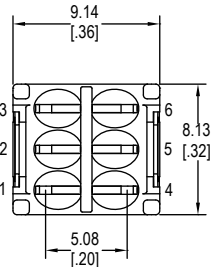
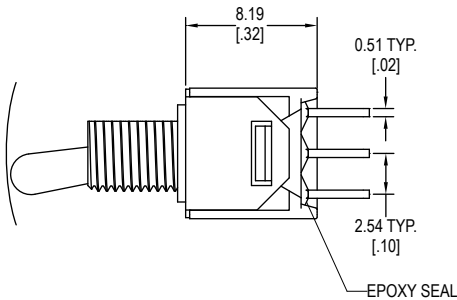

Actuator Options

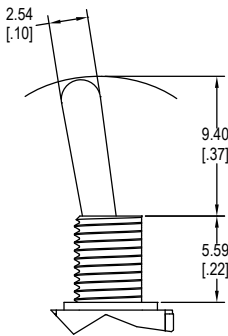

S

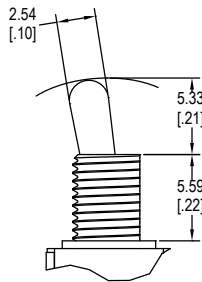

T

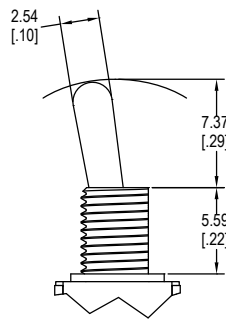

U

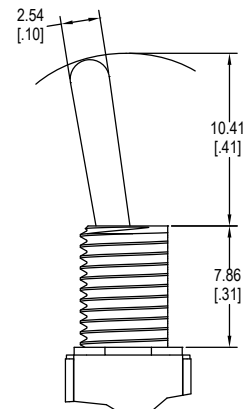

V

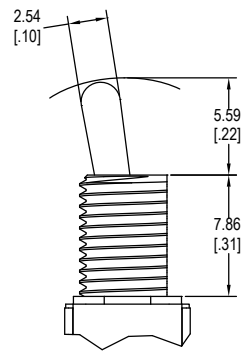

X

Panel Mounting

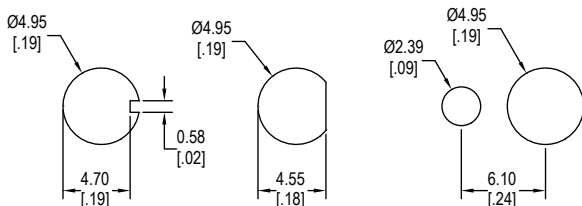

Used with E, E1, F & F1

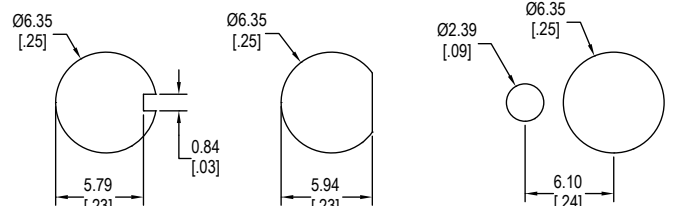

Used with G, G1, J & J1

Bushing Options

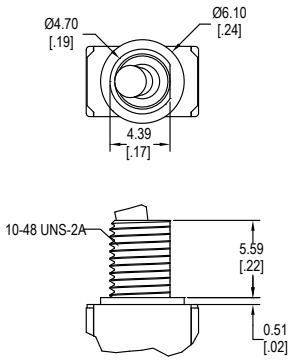

E

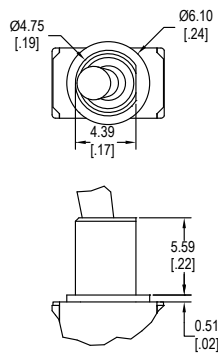

E1

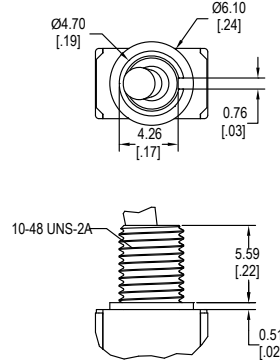

F

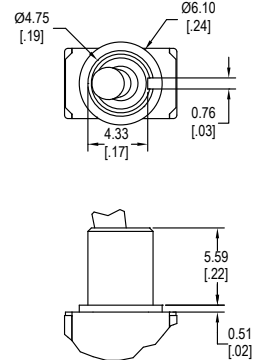

F1

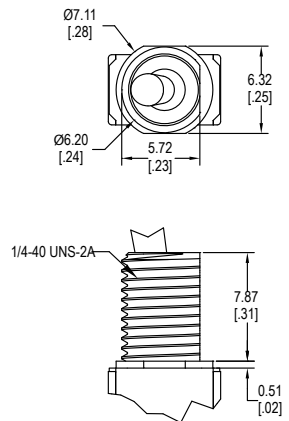

G

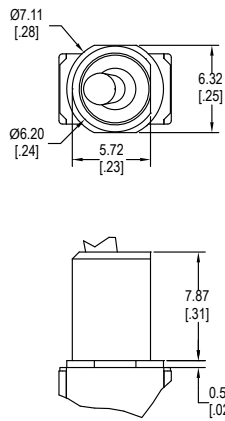

G1

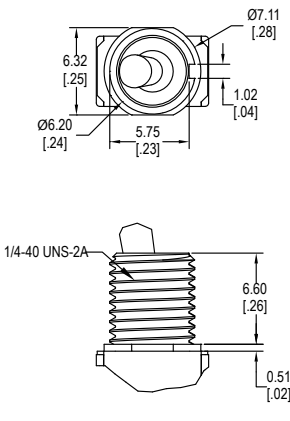

J

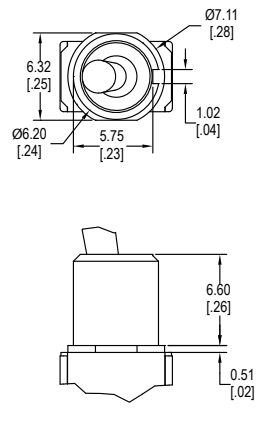

J1

Terminal Options

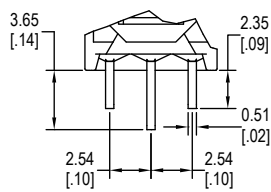

B - SPDT

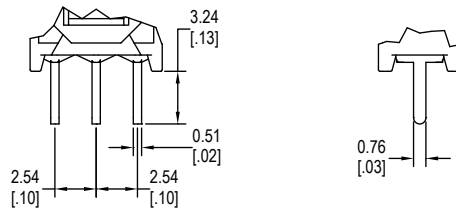

C - SPDT

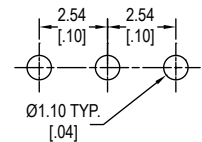

PC Layout

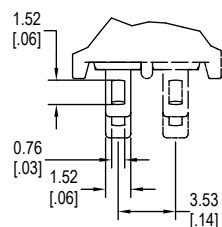

B - DPDT

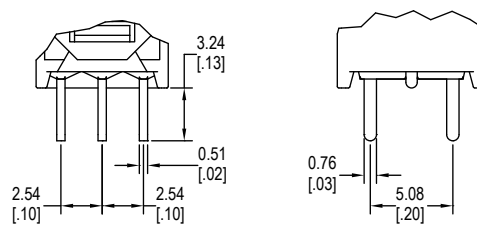

C - DPDT

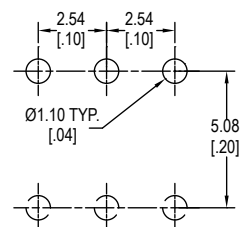

PC Layout

Terminal Options

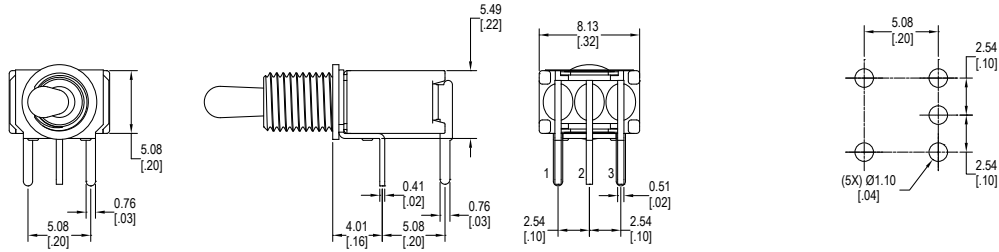

H = Horizontal mount, right angle PC pins, single pole, single throw

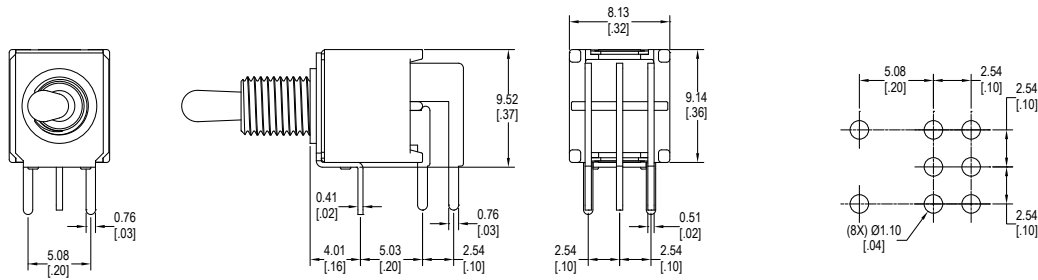

H = Horizontal mount, right angle PC pins, double pole, double throw

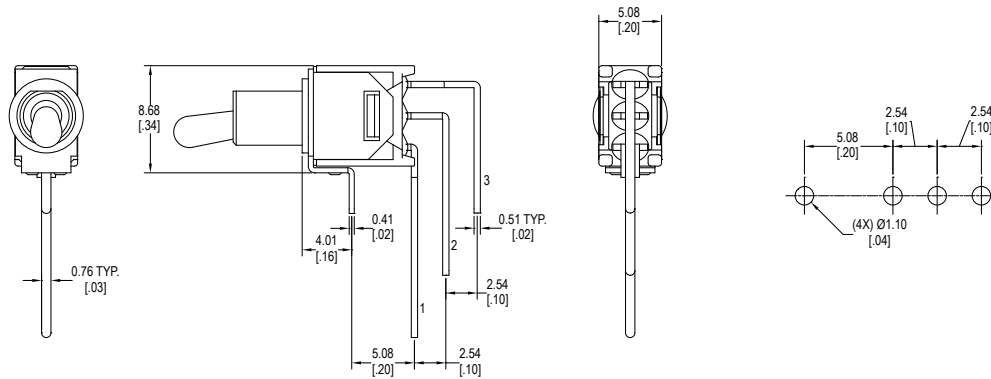

V = Vertical mount, right angle PC pins, single pole, single throw

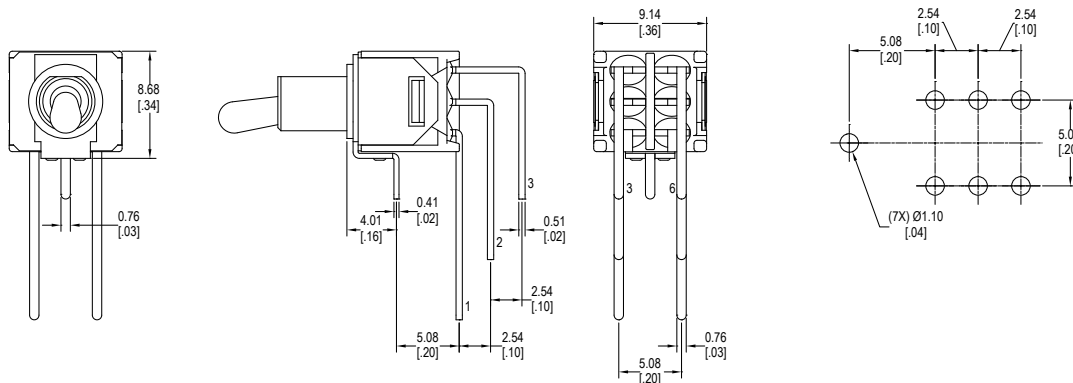

V = Vertical mount, right angle PC pins, double pole, double throw

Terminal Options

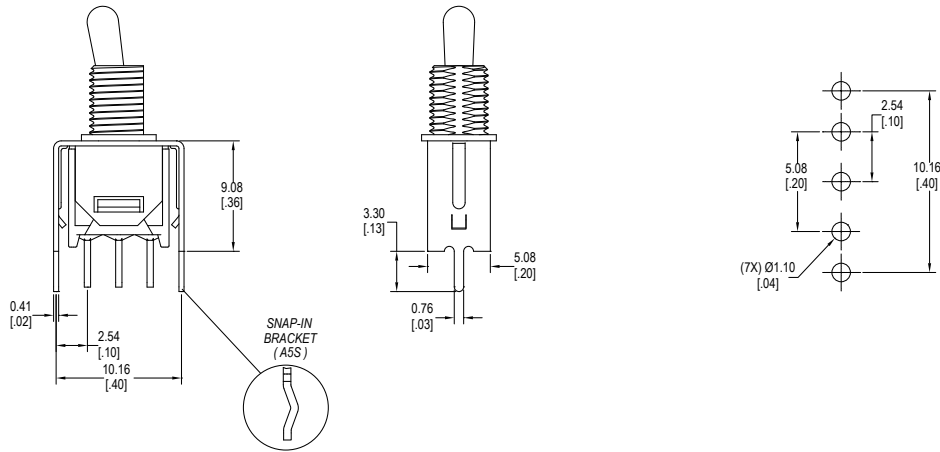

A5 (A5S - Snap in bracket) = PC pins with support bracket, single pole single throw

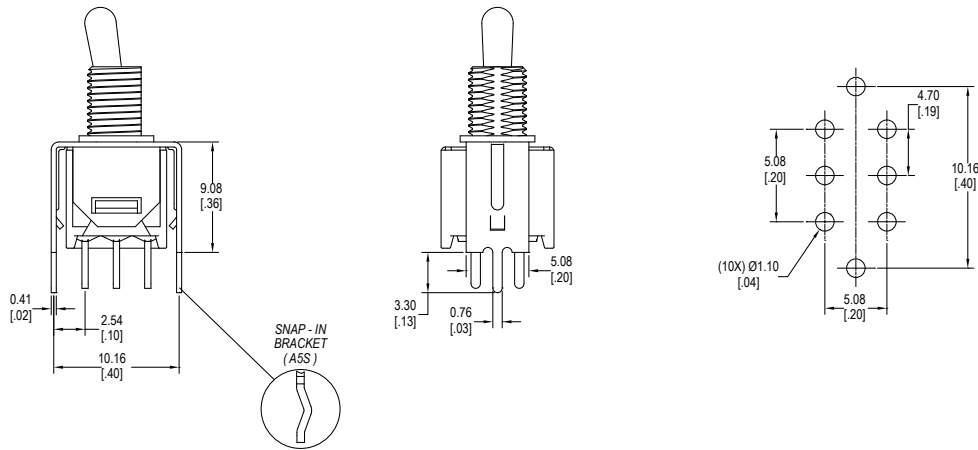

A5 (A5S - Snap in bracket) = PC pins with support bracket, double pole double throw

Contact Options

Designator	Contact Material	Terminal Material	Electrical Ratings
Q	Silver Plating	Silver Plating	3A @ 120VAC, 28VDC; 1A @ 250VAC
R	Gold over Nickel Plating	Gold over Nickel Plating	0.4VA max @ 20VAC or VDC max
G	Gold over Silver Plating	Gold over Silver Plating	0.4VA max @ 20VAC or VDC max or 3A @ 120VAC, 28VDC; 1A @ 250VAC

Hardware

Two hex nuts, one lock washer & one locking ring supplied standard with threaded bushings

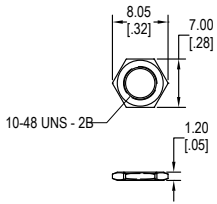

10 - 48 Hex Nut

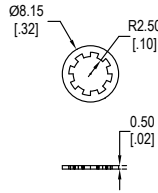

Lock Washer

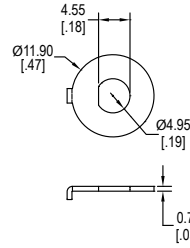

Locking Ring (Flat)

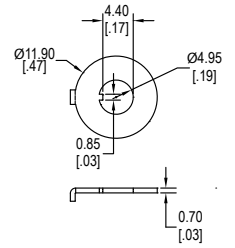

Locking Ring (Keyway)

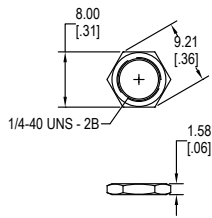

1/4 - 40 Hex Nut

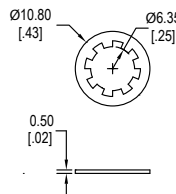

Lock Washer

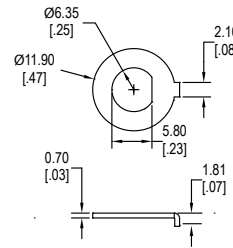

Locking Ring (Flat)

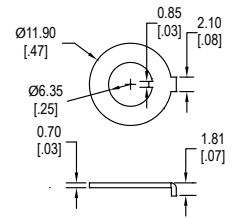

Locking Ring (Keyway)

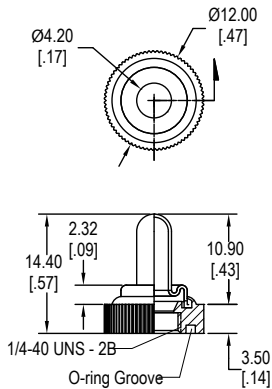

Sealed Boot - E Knurled Nut

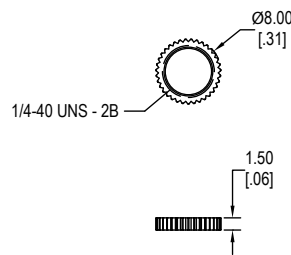

Knurled Nuts

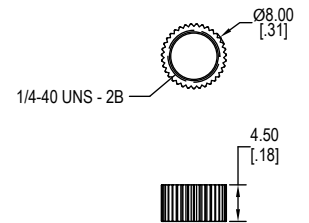

Hardware - Dress Nut

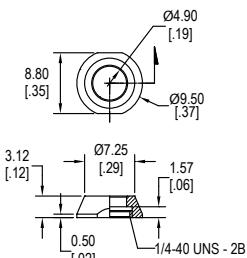

A

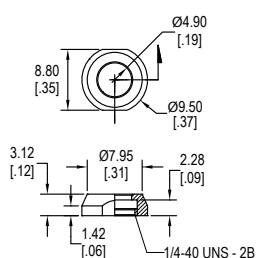

B

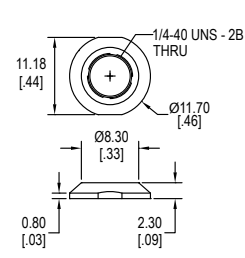
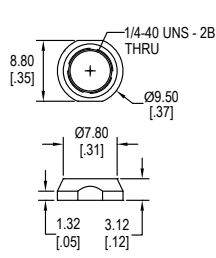

D

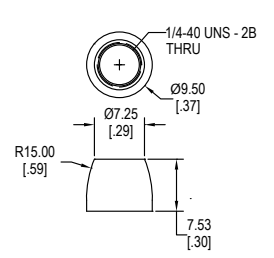

E