

14-Bit, 1/3/8 MSPS, DSP-COMPATIBLE ANALOG-TO-DIGITAL CONVERTERS WITH INTERNAL REFERENCE AND PGA

FEATURES

- 14-Bit Resolution
- 1, 3, and 8 MSPS Speed Grades Available
- Differential Nonlinearity (DNL) ± 0.6 LSB Typ
- Integral Nonlinearity (INL) ± 1.5 LSB Typ
- Internal Reference
- Differential Inputs
- Programmable Gain Amplifier
- μ P-Compatible Parallel Interface
- Timing Compatible With TMS320C6000 DSP
- 3.3-V Single Supply
- Power-Down Mode
- Monolithic CMOS Design

APPLICATIONS

- xDSL Front Ends
- Communication
- Industrial Control
- Instrumentation
- Automotive

DESCRIPTION

The THS1401, THS1403, and THS1408 are 14-bit, 1/3/8 MSPS, single supply analog-to-digital converters (ADCs) with an internal reference, differential inputs, programmable input gain, and an on-chip sample-and-hold amplifier.

Implemented with a CMOS process, the device has outstanding price/performance and power/speed ratios. The THS1401, THS1403, and THS1408 are designed for use with 3.3-V systems, and with a high-speed μ P-compatible parallel interface, making them the first choice for solutions based on high-performance DSPs such as the TI TMS320C6000 series.

The THS1401, THS1403, and THS1408 are available in a TQFP-48 package in standard commercial and industrial temperature ranges. The THS1401, THS1403, and THS1408 are also available in a PQFP-48 package in automotive temperature range, and the THS1408 is available in a PQFP-48 package in military temperature range.

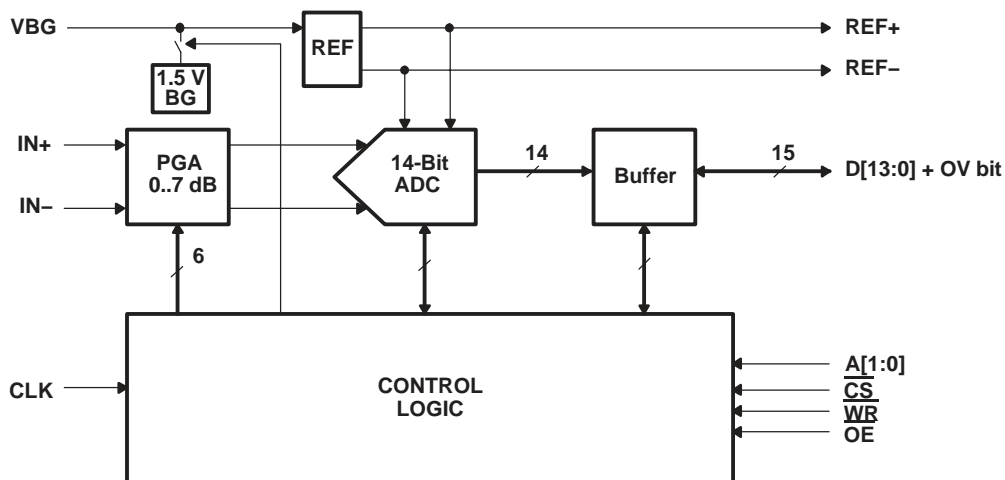

Please be aware that an important notice concerning availability, standard warranty, and use in critical applications of Texas Instruments semiconductor products and disclaimers thereto appears at the end of this data sheet.

All trademarks are the property of their respective owners.

ABSOLUTE MAXIMUM RATINGS

Over operating free-air temperature range unless otherwise noted.⁽¹⁾

Supply voltage, (AV _{DD} to AGND)	4V
Supply voltage, (DV _{DD} to DGND)	4V
Reference input voltage range, VBG	- 0.3 V to AV _{DD} + 0.3 V
Analog input voltage range	- 0.3 V to AV _{DD} + 0.3 V
Digital input voltage range	- 0.3 V to DV _{DD} + 0.3 V
Operating free-air temperature range, T _A : C-suffix	0°C to 70°C
I-suffix	-40°C to 85°C
Q-suffix	-40°C to 125°C
M-suffix	-55°C to 125°C
Storage temperature range, T _{stg}	-65°C to 150°C
Lead temperature 1,6 mm (1/16 inch) from case for 10 seconds	260°C

⁽¹⁾ Stresses beyond those listed under *absolute maximum ratings* may cause permanent damage to the device. These are stress ratings only, and functional operation of the device at these or any other conditions beyond those indicated under *recommended operating conditions* is not implied. Exposure to absolute-maximum-rated conditions for extended periods may affect device reliability.

Terminal Functions

TERMINAL		I/O	DESCRIPTION
NAME	NO.		
A[1:0]	40, 41	I	Address input
AGND	7, 8, 44, 45, 46		Analog ground
AV _{DD}	2, 43, 47		Analog power supply
CLK	32	I	Clock input
CML	4		Reference midpoint. This pin requires a 0.1-μF capacitor to AGND.
$\overline{\text{CS}}$	37	I	Chip select input. Active low.
DGND	9, 15, 25, 33, 34		Digital ground
DV _{DD}	14, 20, 26, 30, 31, 42		Digital power supply
D[13:0]	11, 12, 13, 16, 17, 18, 19, 21, 22, 23, 24, 27, 28, 29	I/O	Data inputs/outputs
NC	38, 39		No connection; do not use. Reserved.
IN+	48	I	Positive differential analog input
IN-	1	I	Negative differential analog input
$\overline{\text{OE}}$	35	I	Output enable. Active low.
OV	10	O	Out-of-range output
REF+	5	O	Positive reference output. This pin requires a 0.1-μF capacitor to AGND.
REF-	6	O	Negative reference output. This pin requires a 0.1-μF capacitor to AGND.
VBG	3	I	Reference input. This pin requires a 1-μF capacitor to AGND.
$\overline{\text{WR}}$	36	I	Write signal. Active low.

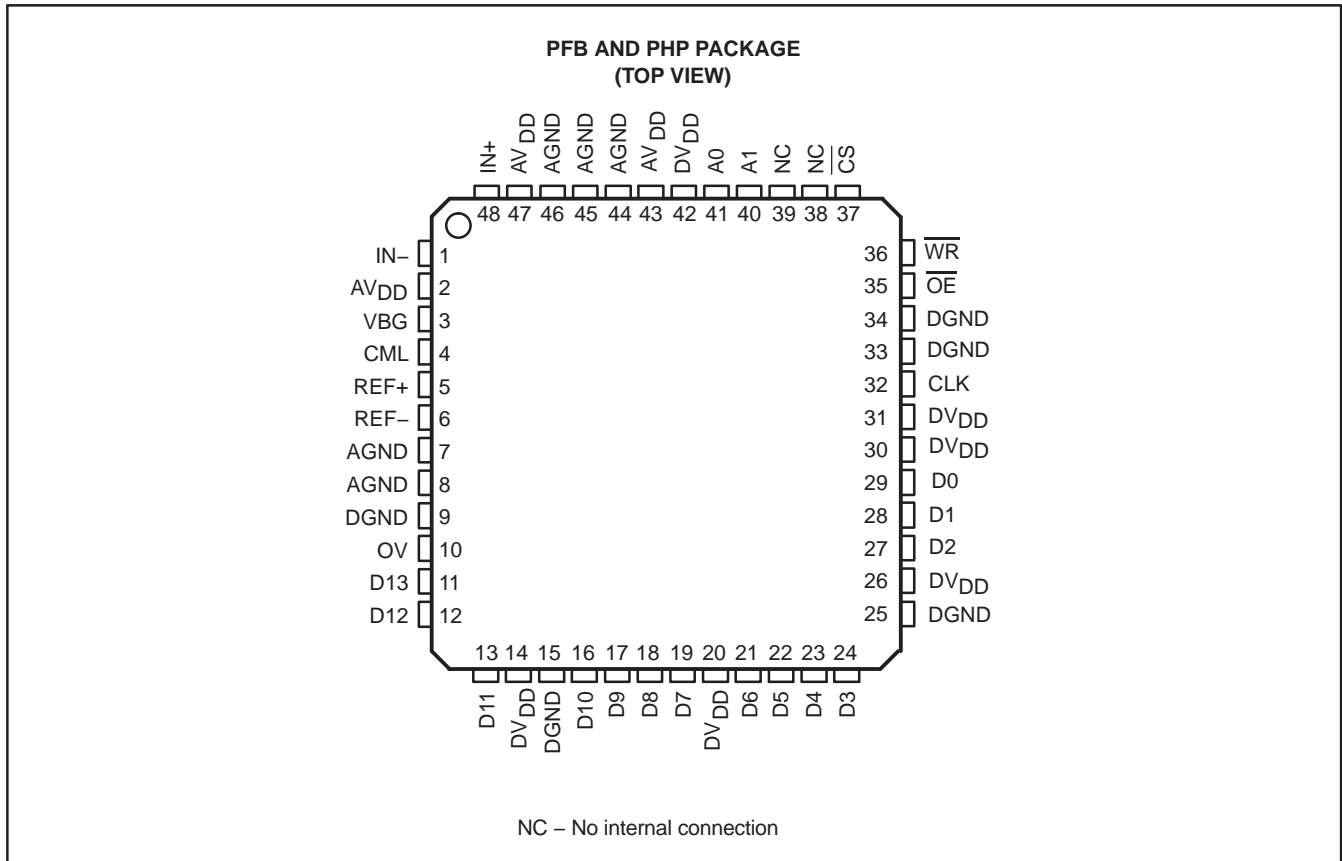

AVAILABLE OPTIONS

T _A	PACKAGED DEVICE	
	TQFP (PFB)	PQFP (Power Pad) (PHP)
0°C to 70°C	THS1401CPFB, THS1403CPFB, THS1408CPFB	—
–40°C to 85°C	THS1401IPFB, THS1403IPFB, THS1408IPFB	—
–40°C to 125°C	—	THS1401QPHP, THS1403QPHP, THS1408QPHP
–55°C to 125°C	—	THS1408MPHP

THERMAL CHARACTERISTICS(1)

		TYP	UNIT
Thermal resistance, junction-to-ambient, Θ_{JA}	PFB package	85.9	°C/W
	PHP package	28.8	
Thermal resistance, junction-to-case, Θ_{JC}	PFB package	19.6	°C/W
	PHP package	0.79	

(1) Thermal resistance is modeled data, is not production tested, and is given for informational purposes only.

RECOMMENDED OPERATING CONDITIONS

		MIN	NOM	MAX	UNIT
Supply voltage, V_{DD} , DV_{DD}		3	3.3	3.6	V
High level digital input, V_{IH}		2	3.3		V
Low level digital input, V_{IL}			0	0.8	V
Load capacitance, C_L			5	15	pF
Clock frequency, f_{CLK}	THS1401	0.1	1	1	MHz
	THS1403	0.1	3	3	MHz
	THS1408	0.1	8	8	MHz
Clock duty cycle	C- and I-suffix	40	50	60	%
	Q- and M-suffix	45	50	55	
Operating free-air temperature	C-suffix	0	25	70	°C
	I-suffix	-40	25	85	
	Q-suffix	-40	25	125	
	M-suffix	-55	25	125	

ELECTRICAL CHARACTERISTICS

Over operating free-air temperature range, AVDD = DVDD = 3.3V, unless otherwise noted.

PARAMETER		TEST CONDITIONS	MIN	TYP	MAX	UNIT
Power Supply						
I _{DDA}	Analog supply current	AV _{DD} = 3.6 V		81	90	mA
I _{DDD}	Digital supply current	DV _{DD} = 3.6 V		5	10	mA
	Power	AV _{DD} = DV _{DD} = 3.6 V		270	360	mW
	Power down current			20		μA
DC Characteristics						
	Resolution			14		Bits
DNL	Differential nonlinearity			±0.6	±1	LSB
INL	Integral nonlinearity	THS1401	Best fit	±1.5	±2.5	LSB
		THS1403C/I		±1.5	±2.5	
		THS1403Q		±2	±3	
		THS1408C/I		±3	±5	
		THS1408Q/M		±3.5	±7.5	
	Offset error	IN+ = IN-, PGA = 0 dB			0.3	%FSR
	Gain error	C and I suffix	PGA = 0 dB		1	%FSR
		Q and M suffix			1.75	%FSR
AC Characteristics						
ENOB	Effective number of bits		11.2	11.5		Bits
THD	Total harmonic distortion	THS1401/3/8	f _i = 100 kHz		-81	dB
		THS1403/8	f _i = 1 MHz		-78	
		THS1408	f _i = 4 MHz		-77	
SNR	Signal-to-noise ratio	THS1401/3/8	f _i = 100 kHz		72	dB
		THS1403/8	f _i = 1 MHz	70	72	
		THS1408	f _i = 4 MHz		71	
SINAD	Signal-to-noise ratio + distortion	THS1401/3/8	f _i = 100 kHz		70	dB
		THS1403/8	f _i = 1 MHz	69	70	
		THS1408	f _i = 4 MHz		70	
SFDR	Spurious-free dynamic range	THS1401/3/8	f _i = 100 kHz		80	dB
		THS1403C/I, THS1408C/I	f _i = 1 MHz	73	80	
		THS1403Q, THS1408Q/M		71	80	
		THS1408	f _i = 4 MHz		80	
	Analog input bandwidth			140		MHz

ELECTRICAL CHARACTERISTICS (Cont.)

Over operating free-air temperature range, AVDD = DVDD = 3.3V, unless otherwise noted.

PARAMETER		TEST CONDITIONS	MIN	TYP	MAX	UNIT
Reference Voltage						
	Bandgap voltage, internal mode		1.425	1.5	1.575	V
	Input impedance			40		kΩ
	Positive reference voltage, REF+			2.5		V
	Negative reference voltage, REF-			0.5		V
	Reference difference, ΔREF, REF+ – REF-			2		V
	Accuracy, internal reference			5%		
	Temperature coefficient			40		ppm/°C
	Voltage coefficient			200		ppm/V
Analog Inputs						
	Positive analog input, IN+		0	AVDD		V
	Negative analog input, IN-		0	AVDD		V
	Analog input voltage difference	ΔAIN = IN+ – IN-, VREF = REF+ – REF-	-VREF		VREF	V
	Input impedance			25		kΩ
	PGA range		0		7	dB
	PGA step size			1		dB
	PGA gain error				±0.25	dB
Digital Inputs						
V _{IH}	High-level digital input		2			V
V _{IL}	Low-level digital input				0.8	V
	Input capacitance			5		pF
	Input current				±1	μA
Digital Outputs						
V _{OH}	High-level digital output	I _{OH} = 50 μA	2.6			V
V _{OL}	Low-level digital output	I _{OL} = 50 μA			0.4	V
I _{OZ}	Output current, high impedance				±10	μA
Clock Timing (CS low)						
f _{CLK}	Clock frequency	THS1401	0.1 [†]	1	1	MHz
		THS1403	0.1 [†]	3	3	MHz
		THS1408	0.1 [†]	8	8	MHz
t _d	Output delay time				25	ns
	Latency				9.5	Cycles

[†] This parameter is not production tested for Q- and M-suffix devices.

PARAMETER MEASUREMENT INFORMATION

sample timing

The THS1401/3/8 core is based on a pipeline architecture with a latency of 9.5 samples. The conversion results appear on the digital output 9.5 clock cycles after the input signal was sampled.

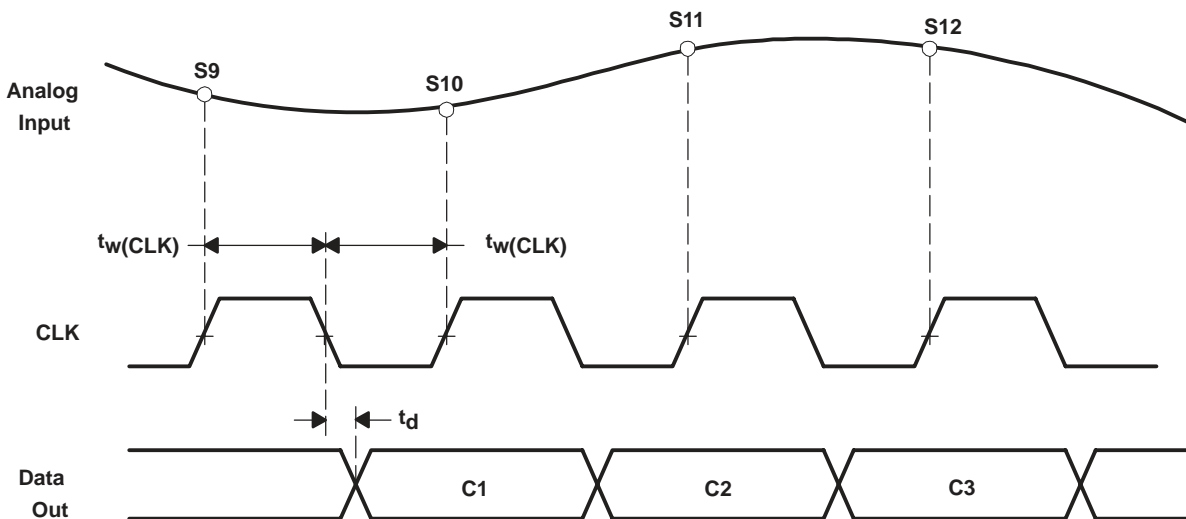

Figure 1. Sample Timing

The parallel interface of the THS1401/3/8 ADC features 3-state buffers, making it possible to directly connect it to a data bus. The output buffers are enabled by driving the OE input low.

Besides the sample results, it is also possible to read back the values of the control register, the PGA register, and the offset register. Which register is read is determined by the address inputs A[1,0]. The ADC results are available at address 0.

The timing of the control signals is described in the following sections.

PARAMETER MEASUREMENT INFORMATION

read timing (15-pF load)

PARAMETER	MIN	TYP	MAX	UNIT
$t_{su}(OE-ACS)$ Address and chip select setup time	4			ns
t_{en} Output enable			15	ns
t_{dis} Output disable		10		ns
$t_h(A)$ Address hold time	1			ns
$t_h(CS)$ Chip select hold time	0			ns

NOTE: All timing parameters refer to a 50% level.

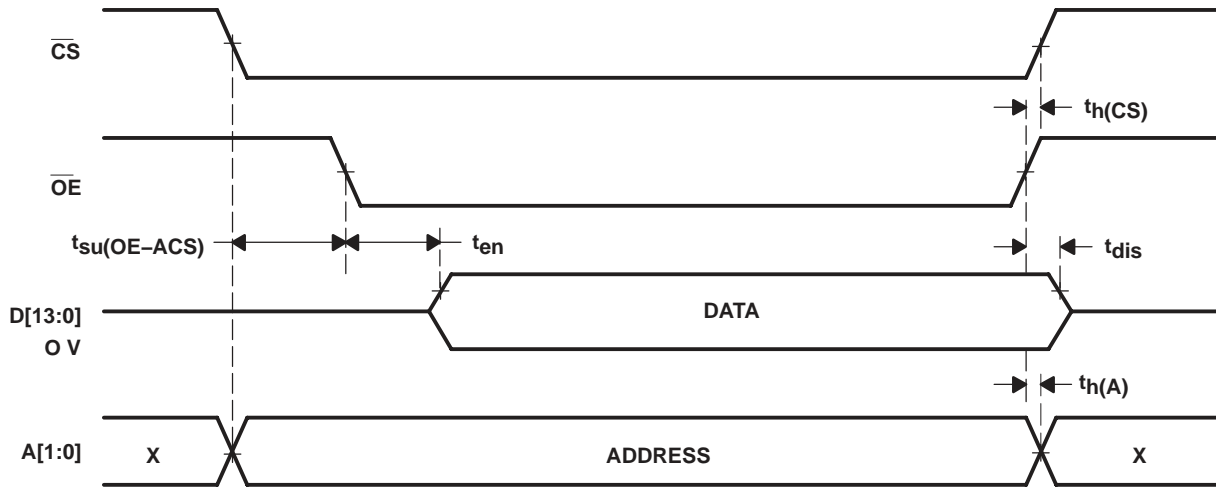

Figure 2. Read Timing

PARAMETER MEASUREMENT INFORMATION

write timing (15-pF load)

PARAMETER		MIN	TYP	MAX	UNIT
$t_{su}(WE-CS)$	Chip select setup time	4			ns
$t_{su}(DA)$	Data and address setup time	29			ns
$t_h(DA)$	Data and address hold time	0			ns
$t_h(CS)$	Chip select hold time	0			ns
$t_{wH}(WE)$	Write pulse duration high	15			ns

NOTE: All timing parameters refer to a 50% level.

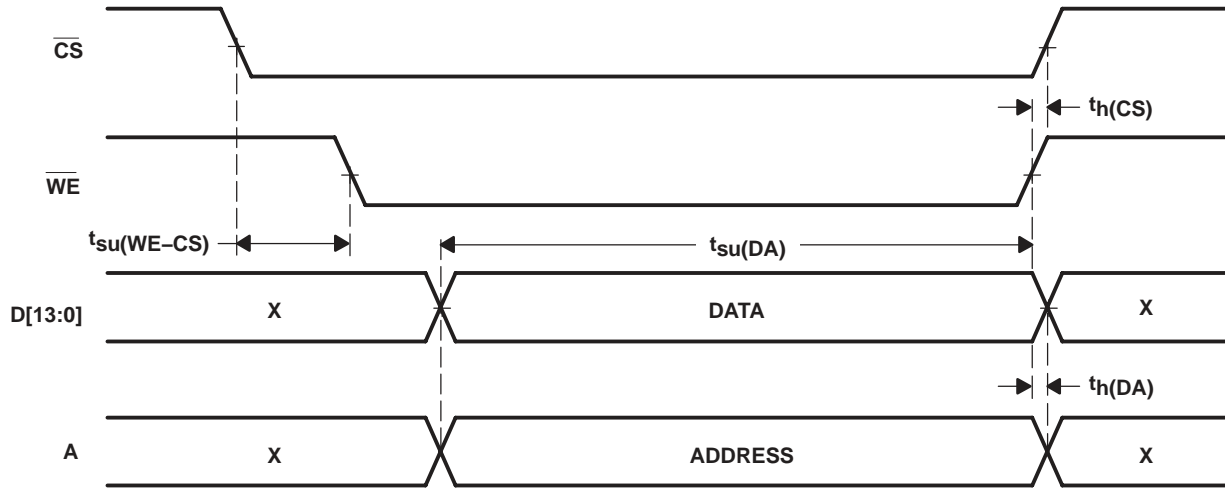

Figure 3. Write Timing

TYPICAL CHARACTERISTICS

POWER
 vs
 FREQUENCY

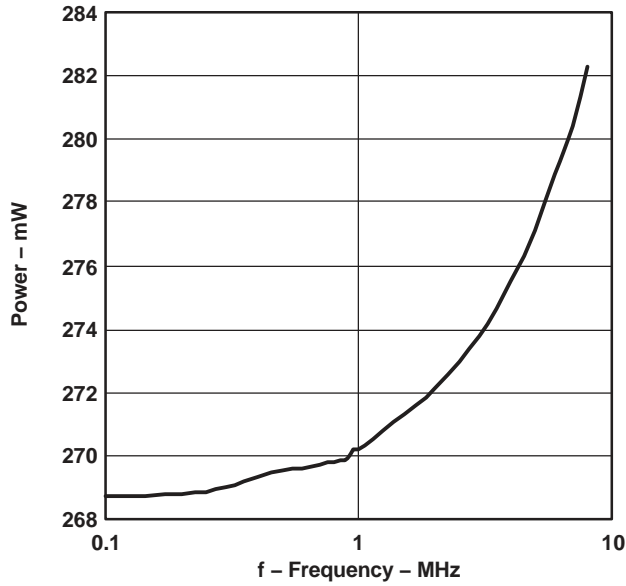

Figure 4

SUPPLY CURRENT
 vs
 TIME

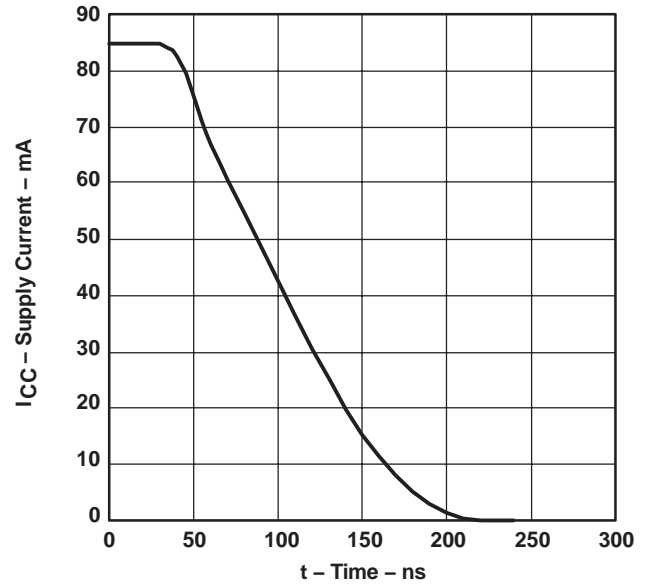

Figure 5

FAST FOURIER TRANSFORM

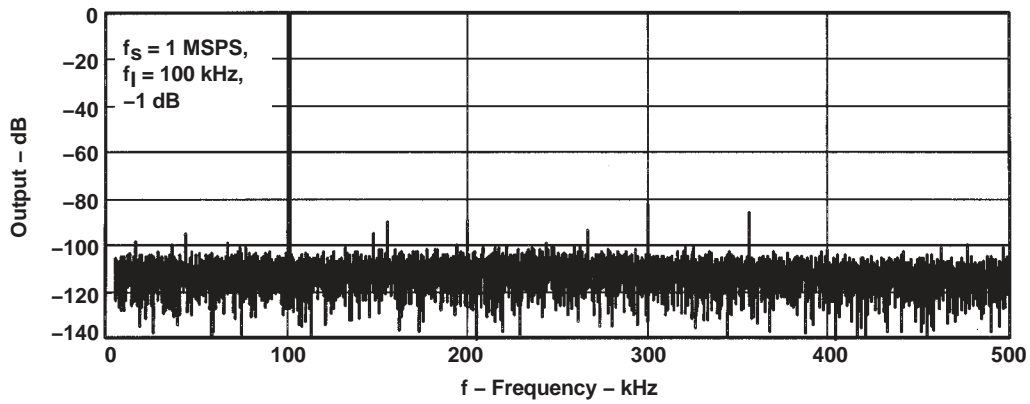

Figure 6

TYPICAL CHARACTERISTICS

FAST FOURIER TRANSFORM

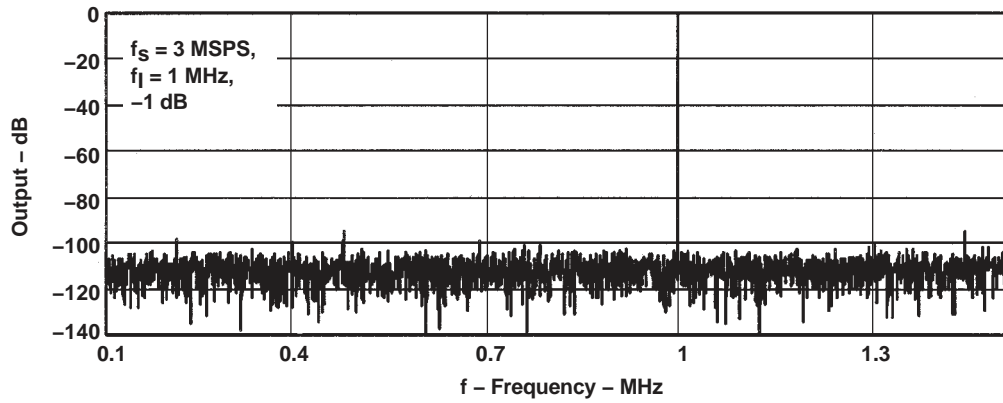

Figure 7

FAST FOURIER TRANSFORM

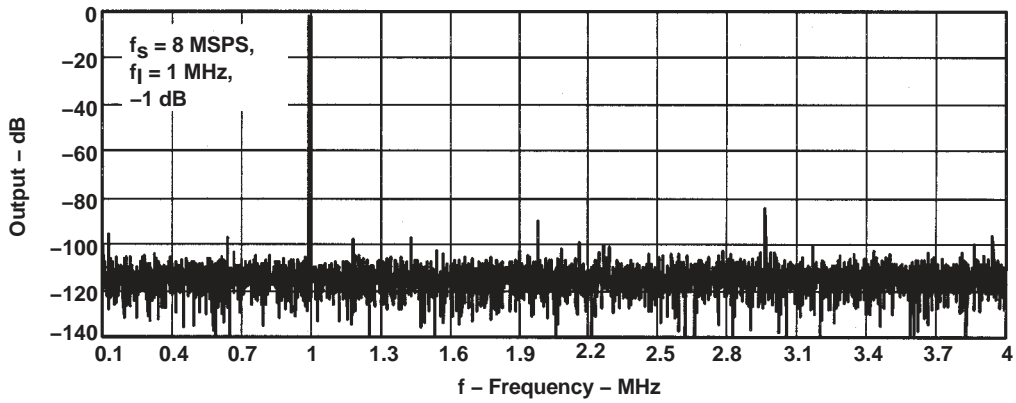

Figure 8

INTEGRAL NONLINEARITY

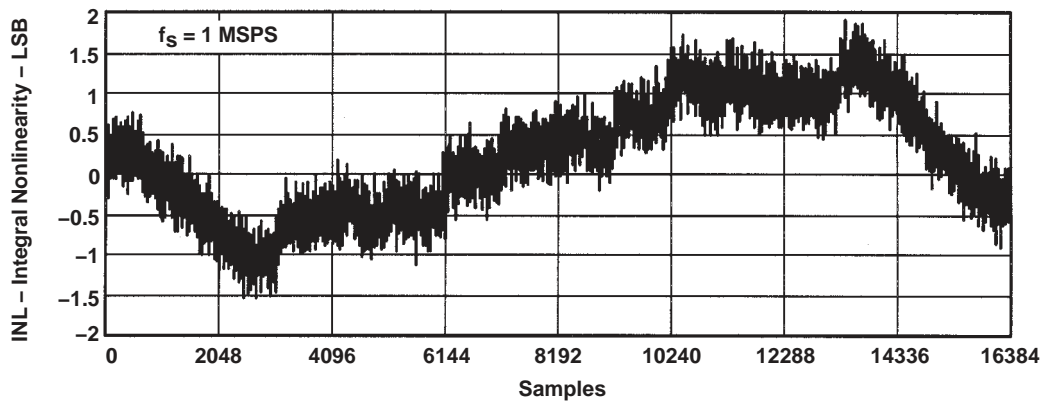

Figure 9

TYPICAL CHARACTERISTICS

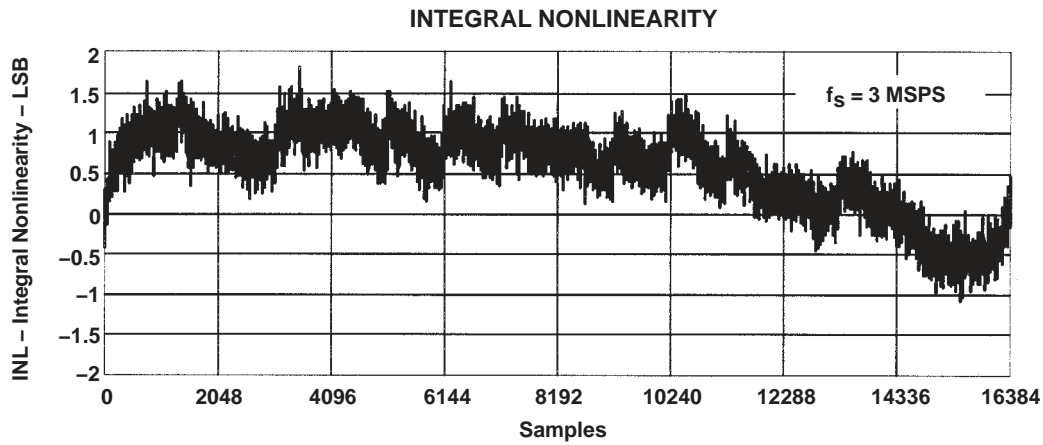

Figure 10

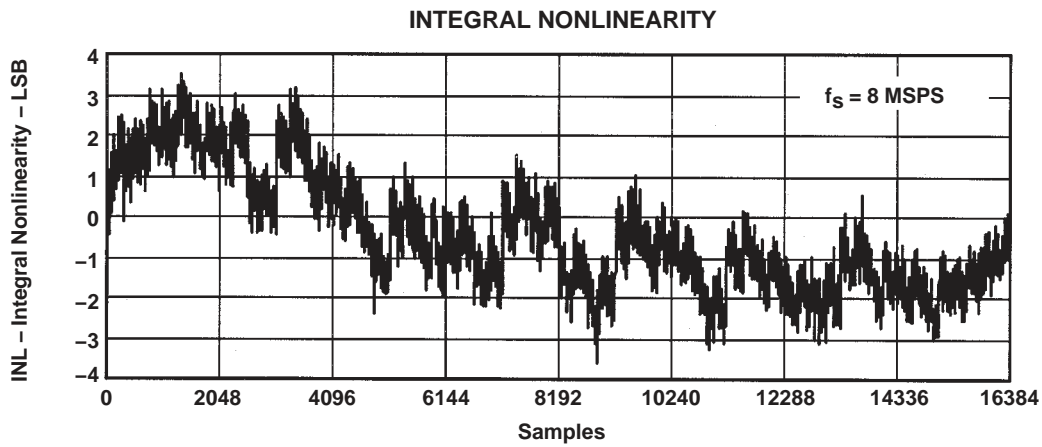

Figure 11

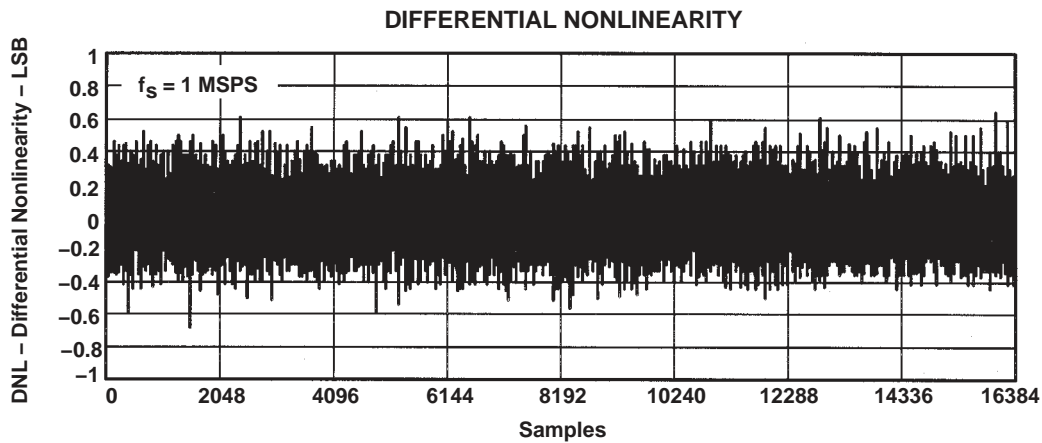

Figure 12

TYPICAL CHARACTERISTICS

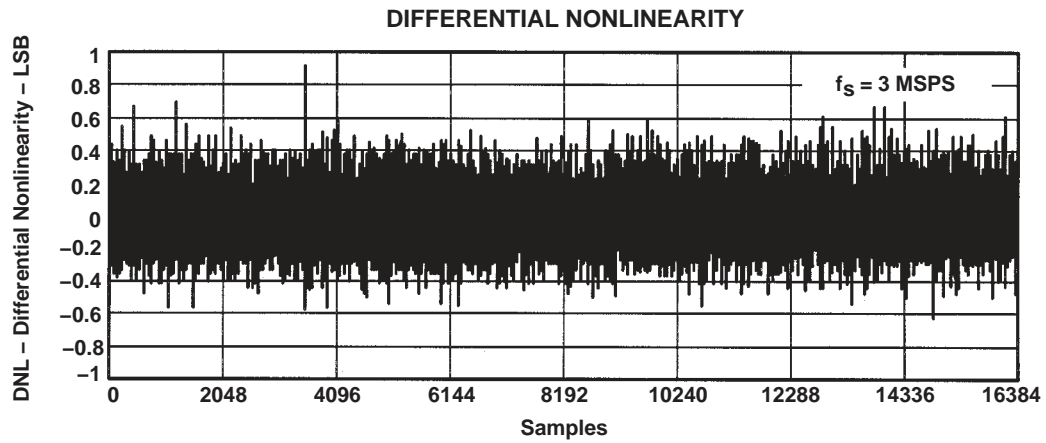

Figure 13

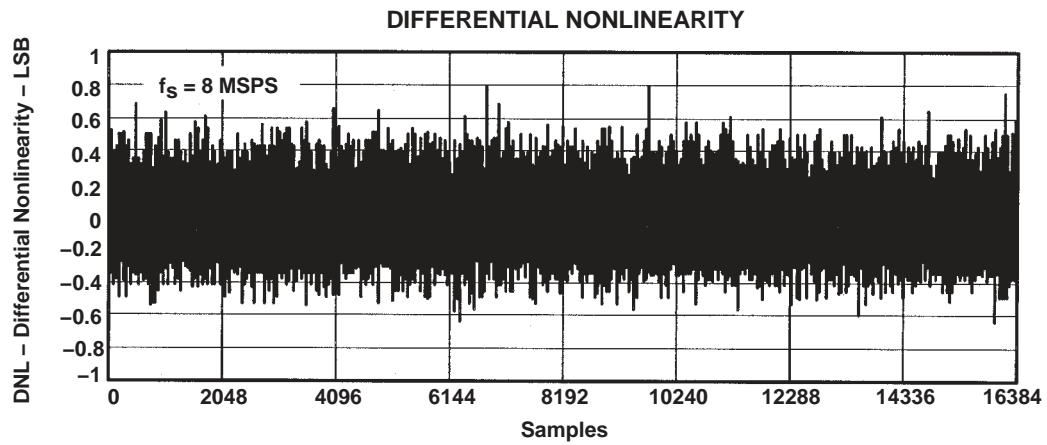

Figure 14

TYPICAL CHARACTERISTICS

TOTAL HARMONIC DISTORTION
 vs
 FREQUENCY

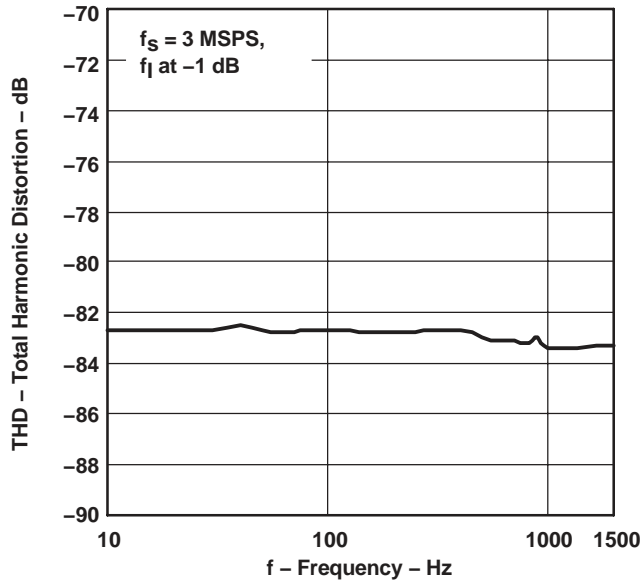

Figure 15

TOTAL HARMONIC DISTORTION
 vs
 FREQUENCY

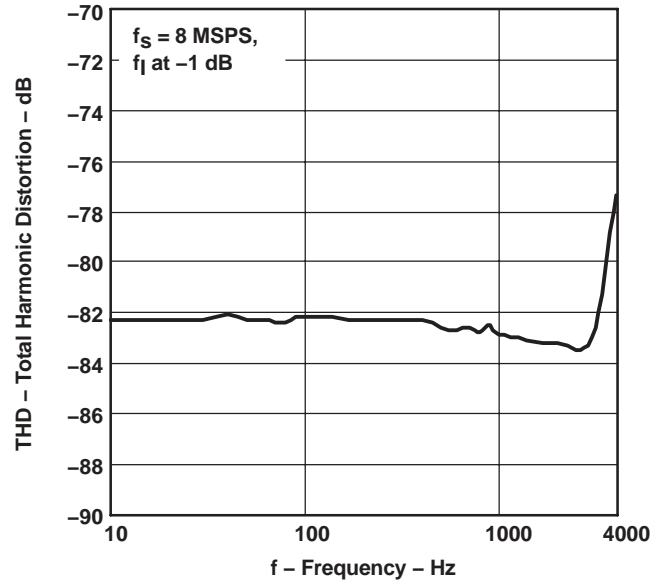

Figure 16

SIGNAL-TO-NOISE RATIO
 vs
 FREQUENCY

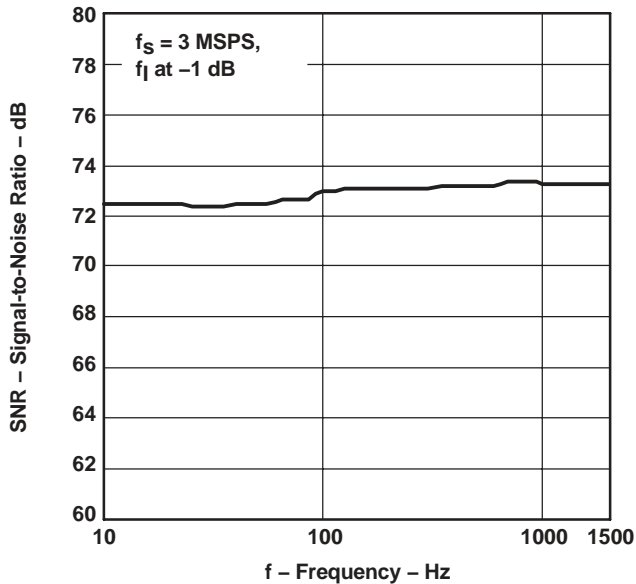

Figure 17

SIGNAL-TO-NOISE RATIO
 vs
 FREQUENCY

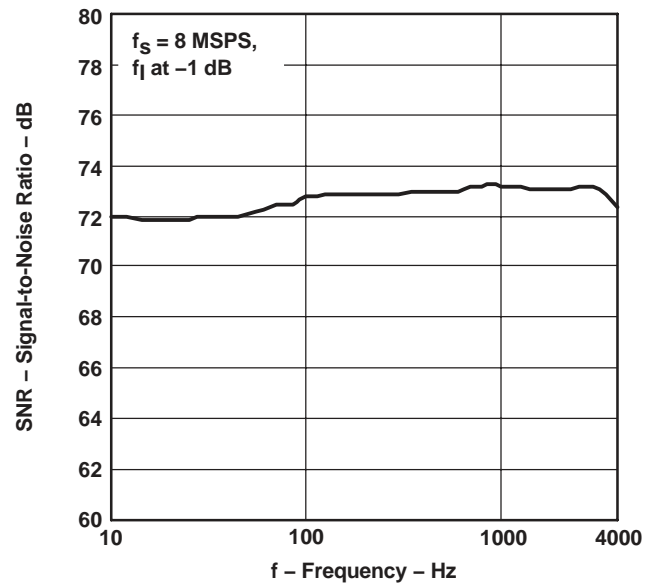

Figure 18

PRINCIPLES OF OPERATION

registers

The device contains several registers. The A register is selected by the values of bits A1 and A0:

A1	A0	Register
0	0	Conversion result
0	1	PGA
1	0	Offset
1	1	Control

Tables 1 and 2 describe how to read the conversion results and how to configure the data converter. The default values (were applicable) show the state after a power-on reset.

Table 1. Conversion Result Register, Address 0, Read

BIT	D13	D12	D11	D10	D9	D8	D7	D6	D5	D4	D3	D2	D1	D0
Function	MSB	LSB

The output can be configured for 2s complement or straight binary format (see D11/control register).

The output code is given by:

2s complement:

–8192 at $\Delta IN = -\Delta REF$

0 at $\Delta IN = 0$

8191 $\Delta IN = +\Delta REF - 1 \text{ LSB}$

Straight binary:

0 at $\Delta IN = -\Delta REF$

8192 at $\Delta IN = 0$

16383 at $\Delta IN = +\Delta REF - 1 \text{ LSB}$

$$1 \text{ LSB} = \frac{2\Delta REF}{16384}$$

Table 2. PGA Gain Register, Address 1, Read/Write

BIT	D13	D12	D11	D10	D9	D8	D7	D6	D5	D4	D3	D2	D1	D0
Function	X	X	X	X	X	X	X	X	X	X	X	G2	G1	G0
Default	0	0	0	0	0	0	0	0	0	0	0	0	0	0

The PGA gain is determined by writing to G2–0.

Gain (dB) = 1dB × G2–0. max = 7dB. The range of G2–0 is 0 to 7.

Table 3. Offset Register, Address 2, Read/Write

BIT	D13	D12	D11	D10	D9	D8	D7	D6	D5	D4	D3	D2	D1	D0
Function	X	X	X	X	X	X	MSB	LSB
Default	0	0	0	0	0	0	0	0	0	0	0	0	0	0

The offset correction range is from –128 to 127 LSB. This value is added to the conversion results from the ADC.

PRINCIPLES OF OPERATION

Table 4. Control Register, Address 3, Read

BIT	D13	D12	D11	D10	D9	D8	D7	D6	D5	D4	D3	D2	D1	D0
Function	PWD	REF	FOR	TM2	TM1	TM0	OFF	RES	RES	RES	RES	RES	RES	RES

Table 5. Control Register, Address 3, Write

BIT	D13	D12	D11	D10	D9	D8	D7	D6	D5	D4	D3	D2	D1	D0
Function	PWD	REF	FOR	TM2	TM1	TM0	OFF	RES	RES	RES	RES	RES	RES	RES
Default	0	0	0	0	0	0	0	0	0	0	0	0	0	0

PWD:	Power down	0 = normal operation	1 = power down
REF:	Reference select	0 = internal reference	1 = external reference
FOR:	Output format	0 = straight binary	1 = 2s complement
TM2–0:	Test mode	000 = normal operation	
		001 = both inputs = REF–	
		010 = IN+ at V_{CM} (Voltage at CML pin), IN– at REF–	
		011 = IN+ at REF+, IN– at REF–	
		100 = normal operation	
		101 = both inputs = REF+	
		110 = IN+ at REF–, IN– at V_{CM} (Voltage at CML pin)	
		111 = IN+ at REF–, IN– at REF+	
OF:	Offset correction	0 = enable	1 = disable
RES	Reserved	Must be set to 0.	

APPLICATION INFORMATION

driving the analog input

The THS1401/3/8 ADCs have a fully differential input. A differential input is advantageous with respect to SNR, SFDR, and THD performance because the signal peak-to-peak level is 50% of a comparable single-ended input.

There are three basic input configurations:

- Fully differential
- Transformer coupled single-ended to differential
- Single-ended

fully differential configuration

In this configuration, the ADC converts the difference (ΔIN) of the two input signals on IN+ and IN–.

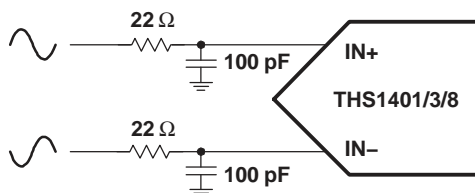

Figure 19. Differential Input

The resistors and capacitors on the inputs decouple the driving source output from the ADC input and also serve as first order low pass filters to attenuate out of band noise.

The input range on both inputs is 0 V to AV_{DD} . The full-scale value is determined by the voltage reference. The positive full-scale output is reached, if ΔIN equals ΔREF , the negative full-scale output is reached, if ΔIN equals $-\Delta REF$.

ΔIN [V]	OUTPUT
$-\Delta REF$	- full scale
0	0
ΔREF	+ full scale

APPLICATION INFORMATION

transformer coupled single-ended to differential configuration

If the application requires the best SNR, SFDR, and THD performance, the input should be transformer coupled.

The signal amplitude on both inputs of the ADC is one half as high as in a single-ended configuration thus increasing the ADC ac performance.

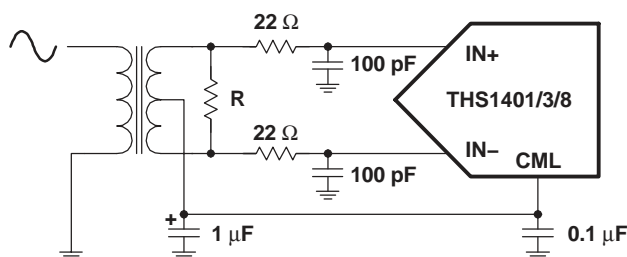

Figure 20. Transformer Coupled

The following table shows the input voltages for negative full-scale output, zero output, and positive full-scale output:

IN [V _{PEAK}]	OUTPUT [PEAK]
$-\Delta REF$	- full scale [†]
0	0
ΔREF	+ full scale [†]

[†] n = 1 (winding ratio)

The resistor R of the transformer coupled input configuration must be set to match the signal source impedance $R = n^2 R_s$, where R_s is the source impedance and n is the transformer winding ratio.

APPLICATION INFORMATION

single-ended configuration

In this configuration, the input signal is level shifted by $\Delta REF/2$.

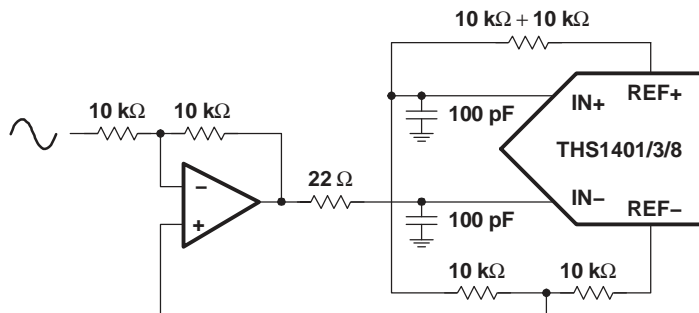

Figure 21. Single-Ended With Level Shift

The following table shows the input voltages for negative full-scale output, zero output, and positive full-scale output:

$\Delta IN+$ [V]	OUTPUT
$-\Delta REF$	- full scale
0	0
ΔREF	+ full scale

Note that the resistors of the op-amp and the op-amp all introduce gain and offset errors. Those errors can be trimmed by varying the values of the resistors.

Because of the added offset, the op-amp does not necessarily operate in the best region of its transfer curve (best linearity around zero) and therefore may introduce unacceptable distortion. For ac signals, an alternative is described in the following section.

APPLICATION INFORMATION

AC-coupled single-ended configuration

If the application does not require the signal bandwidth to include dc, the level shift shown in Figure 21 is not necessary.

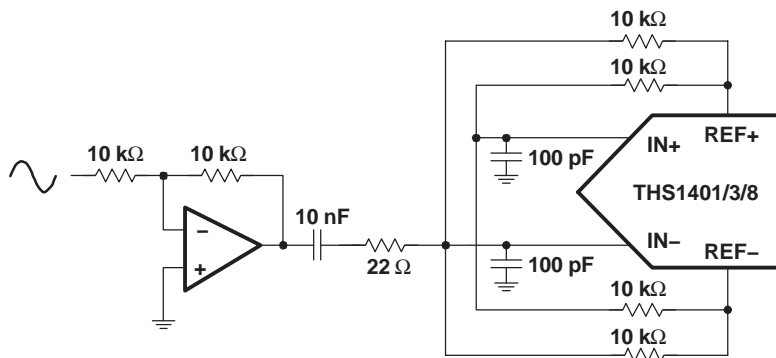

Figure 22. Single-Ended With Level Shift

Because the signal swing on the op-amp is centered around ground, it is more likely that the signal stays within the linear region of the op-amp transfer function, thus increasing the overall ac performance.

IN [V _{PEAK}]	OUTPUT [PEAK]
$-\Delta REF$	- full scale
0	0
ΔREF	+ full scale

Compared to the transformer-coupled configuration, the swing on $IN-$ is twice as big, which can decrease the ac performance (SNR, SFD, and THD).

APPLICATION INFORMATION

internal/external reference operation

The THS1401/3/8 ADC can either be operated using the built-in band gap reference or using an external precision reference in case very high dc accuracy is needed.

The REF+ and REF- outputs are given by:

$$\text{REF} + = \text{VBG} \left(1 + \frac{2}{3} \right) \text{ and } \text{REF} -$$

If the built-in reference is used, VBG equals 1.5 V which results in REF+ = 2.5 V, REF- = 0.5 V and $\Delta\text{REF} = 2 \text{ V}$.

The internal reference can be disabled by writing 1 to D12 (REF) in the control register (address 3). The band gap reference is then disconnected and can be substituted by a voltage on the VBG pin.

programmable gain amplifier

The on-chip programmable gain amplifier (PGA) has eight gain settings. The gain can be changed by writing to the PGA gain register (address 1). The range is 0 to 7dB in steps of one dB.

out of range indication

The OV output of the ADC indicates an out of range condition. Every time the difference on the analog inputs exceeds the differential reference, this signal is asserted. This signal is updated the same way as the digital data outputs and therefore subject to the same pipeline delay.

offset compensation

With the offset register it is possible to automatically compensate system offset errors, including errors caused by additional signal

conditioning circuitry. If the offset compensation is enabled (D7 (OFF) in the control register), the value in the offset register (address 2) is automatically added to the output of the ADC.

In order to set the correct value of the offset compensation register, the ADC result when the input signal is 0 must be read by the host processor and written to the offset register (address 2).

test modes

The ADC core operation can be tested by selecting one of the available test modes (see control register description). The test modes apply various voltages to the differential input depending on the setting in the control register.

digital I/O

The digital inputs and outputs of the THS1401/3/8 ADC are 3-V CMOS compatible. In order to avoid current feed back errors, the capacitive load on the digital outputs should be as low as possible (50 pF max). Series resistors (100 Ω) on the digital outputs can improve the performance by limiting the current during output transitions.

The parallel interface of the THS1401/3/8 ADC features 3-state buffers, making it possible to directly connect it to a data bus. The output buffers are enabled by driving the $\overline{\text{OE}}$ input low.

Refer to the read and write timing diagrams in the parameter measurement information section for information on read and write access.

Revision History

DATE	REV	PAGE	SECTION	DESCRIPTION
9/05	D	1	—	Updated page 1 format and layout.
		1	—	Moved funtional block diagram from page 2.
		2	—	Moved Terminal Function table from page 3.
		2	—	Moved Absolute Maximum table from page 4.
		3	—	Moved package pinout from page 1.
		3	—	Moved Ordering Options table from page 2.
		15	Principles of Operation	Table 1. In section 2s complement: $8191 \Delta IN = - \Delta REF - 1 \text{ LSB}$ changed to $8191 \Delta IN = + \Delta REF - 1 \text{ LSB}$. In section Straight Binary: $16383 \text{ at } \Delta IN = - \Delta REF - 1 \text{ LSB}$ should be changed to $16383 \Delta IN = + \Delta REF - 1 \text{ LSB}$
		16	Principles of Operation	Table 5. In section TM2-0: Test Mode: $010 = IN+ \text{ at } V_{REF}/2$, $IN- \text{ at } REF-$, changed to, $010 = IN+ \text{ at } V_{CM}$ (Voltage at CML pin), $IN- \text{ at } REF-$. Same section: $110 = IN+ \text{ at } REF-$, $IN- \text{ at } V_{REF}/2$, changed to, $110 = IN+ \text{ at } REF-$, $IN- \text{ at } V_{CM}$ (Voltage at CML pin)

NOTE: Page numbers for previous revisions may differ from page numbers in the current version.

PACKAGING INFORMATION

Orderable Device	Status (1)	Package Type	Package Drawing	Pins	Package Qty	Eco Plan (2)	Lead finish/ Ball material (6)	MSL Peak Temp (3)	Op Temp (°C)	Device Marking (4/5)	Samples
5962-0051101NXD	ACTIVE	HTQFP	PHP	48	250	RoHS & Green	NIPDAU	Level-3-260C-168 HR	-55 to 125	0051101 NXD	Samples
THS1401IPFB	ACTIVE	TQFP	PFB	48	250	RoHS & Green	NIPDAU	Level-2-260C-1 YEAR	-40 to 85	TJ1401	Samples
THS1403IPFB	ACTIVE	TQFP	PFB	48	250	RoHS & Green	NIPDAU	Level-2-260C-1 YEAR	-40 to 85	TJ1403	Samples
THS1408IPFB	ACTIVE	TQFP	PFB	48	250	RoHS & Green	NIPDAU	Level-2-260C-1 YEAR	-40 to 85	TJ1408	Samples

(1) The marketing status values are defined as follows:

ACTIVE: Product device recommended for new designs.

LIFEBUY: TI has announced that the device will be discontinued, and a lifetime-buy period is in effect.

NRND: Not recommended for new designs. Device is in production to support existing customers, but TI does not recommend using this part in a new design.

PREVIEW: Device has been announced but is not in production. Samples may or may not be available.

OBSELETE: TI has discontinued the production of the device.

(2) **RoHS:** TI defines "RoHS" to mean semiconductor products that are compliant with the current EU RoHS requirements for all 10 RoHS substances, including the requirement that RoHS substance do not exceed 0.1% by weight in homogeneous materials. Where designed to be soldered at high temperatures, "RoHS" products are suitable for use in specified lead-free processes. TI may reference these types of products as "Pb-Free".

RoHS Exempt: TI defines "RoHS Exempt" to mean products that contain lead but are compliant with EU RoHS pursuant to a specific EU RoHS exemption.

Green: TI defines "Green" to mean the content of Chlorine (Cl) and Bromine (Br) based flame retardants meet JS709B low halogen requirements of <=1000ppm threshold. Antimony trioxide based flame retardants must also meet the <=1000ppm threshold requirement.

(3) MSL, Peak Temp. - The Moisture Sensitivity Level rating according to the JEDEC industry standard classifications, and peak solder temperature.

(4) There may be additional marking, which relates to the logo, the lot trace code information, or the environmental category on the device.

(5) Multiple Device Markings will be inside parentheses. Only one Device Marking contained in parentheses and separated by a "~" will appear on a device. If a line is indented then it is a continuation of the previous line and the two combined represent the entire Device Marking for that device.

(6) Lead finish/Ball material - Orderable Devices may have multiple material finish options. Finish options are separated by a vertical ruled line. Lead finish/Ball material values may wrap to two lines if the finish value exceeds the maximum column width.

Important Information and Disclaimer:The information provided on this page represents TI's knowledge and belief as of the date that it is provided. TI bases its knowledge and belief on information provided by third parties, and makes no representation or warranty as to the accuracy of such information. Efforts are underway to better integrate information from third parties. TI has taken and

continues to take reasonable steps to provide representative and accurate information but may not have conducted destructive testing or chemical analysis on incoming materials and chemicals. TI and TI suppliers consider certain information to be proprietary, and thus CAS numbers and other limited information may not be available for release.

In no event shall TI's liability arising out of such information exceed the total purchase price of the TI part(s) at issue in this document sold by TI to Customer on an annual basis.

OTHER QUALIFIED VERSIONS OF THS1408, THS1408M :

- Catalog: [THS1408](#)
- Enhanced Product: [THS1408-EP](#), [THS1408-EP](#)
- Military: [THS1408M](#)

NOTE: Qualified Version Definitions:

- Catalog - TI's standard catalog product
- Enhanced Product - Supports Defense, Aerospace and Medical Applications
- Military - QML certified for Military and Defense Applications

TRAY

Chamfer on Tray corner indicates Pin 1 orientation of packed units.

*All dimensions are nominal

Device	Package Name	Package Type	Pins	SPQ	Unit array matrix	Max temperature (°C)	L (mm)	W (mm)	K0 (µm)	P1 (mm)	CL (mm)	CW (mm)
5962-0051101NXD	PHP	HTQFP	48	250	10 x 25	150	315	135.9	7620	12.2	11.1	11.25
THS1401IPFB	PFB	TQFP	48	250	10 x 25	150	315	135.9	7620	12.2	11.1	11.25
THS1403IPFB	PFB	TQFP	48	250	10 x 25	150	315	135.9	7620	12.2	11.1	11.25
THS1408IPFB	PFB	TQFP	48	250	10 x 25	150	315	135.9	7620	12.2	11.1	11.25

GENERIC PACKAGE VIEW

PHP 48

TQFP - 1.2 mm max height

7 x 7, 0.5 mm pitch

QUAD FLATPACK

This image is a representation of the package family, actual package may vary.
Refer to the product data sheet for package details.

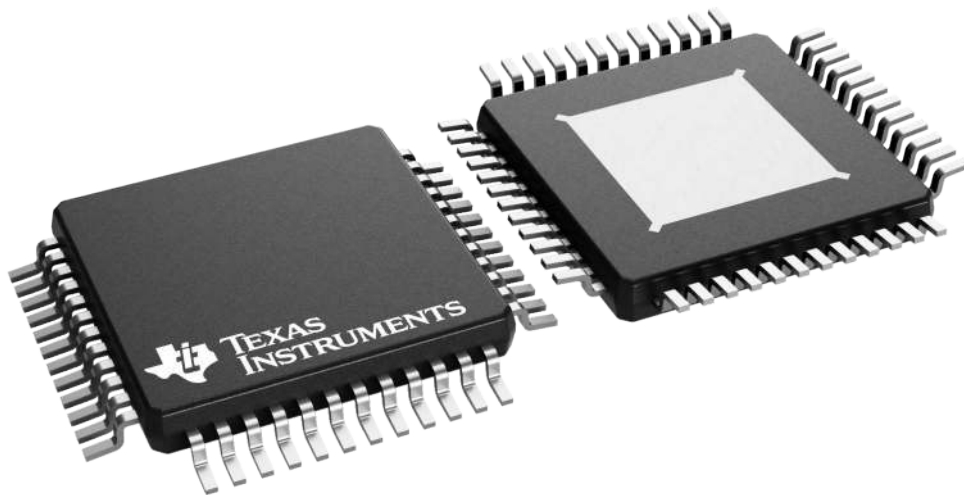

4226443/A

PHP (S-PQFP-G48)

PowerPAD™ PLASTIC QUAD FLATPACK

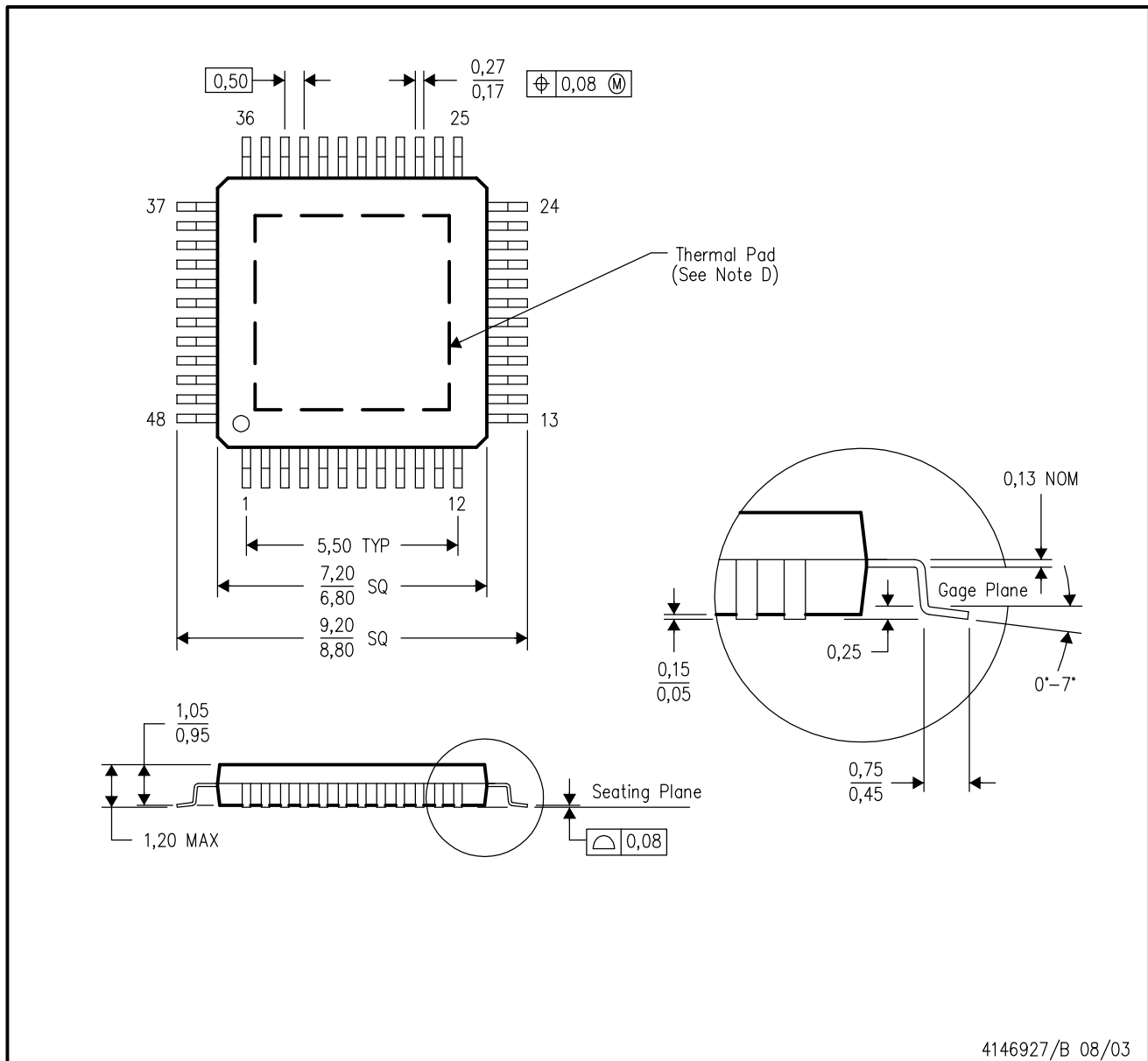

- NOTES:
- All linear dimensions are in millimeters.
 - This drawing is subject to change without notice.
 - Body dimensions do not include mold flash or protrusion.
 - This package is designed to be soldered to a thermal pad on the board. Refer to Technical Brief, PowerPad Thermally Enhanced Package, Texas Instruments Literature No. SLMA002 for information regarding recommended board layout. This document is available at www.ti.com <<http://www.ti.com>>.
 - Falls within JEDEC MS-026

PowerPAD is a trademark of Texas Instruments.

THERMAL PAD MECHANICAL DATA

PHP (S-PQFP-G48)

PowerPAD™ PLASTIC QUAD FLATPACK

THERMAL INFORMATION

This PowerPAD™ package incorporates an exposed thermal pad that is designed to be attached to a printed circuit board (PCB). The thermal pad must be soldered directly to the PCB. After soldering, the PCB can be used as a heatsink. In addition, through the use of thermal vias, the thermal pad can be attached directly to the appropriate copper plane shown in the electrical schematic for the device, or alternatively, can be attached to a special heatsink structure designed into the PCB. This design optimizes the heat transfer from the integrated circuit (IC).

For additional information on the PowerPAD package and how to take advantage of its heat dissipating abilities, refer to Technical Brief, PowerPAD Thermally Enhanced Package, Texas Instruments Literature No. SLMA002 and Application Brief, PowerPAD Made Easy, Texas Instruments Literature No. SLMA004. Both documents are available at www.ti.com.

The exposed thermal pad dimensions for this package are shown in the following illustration.

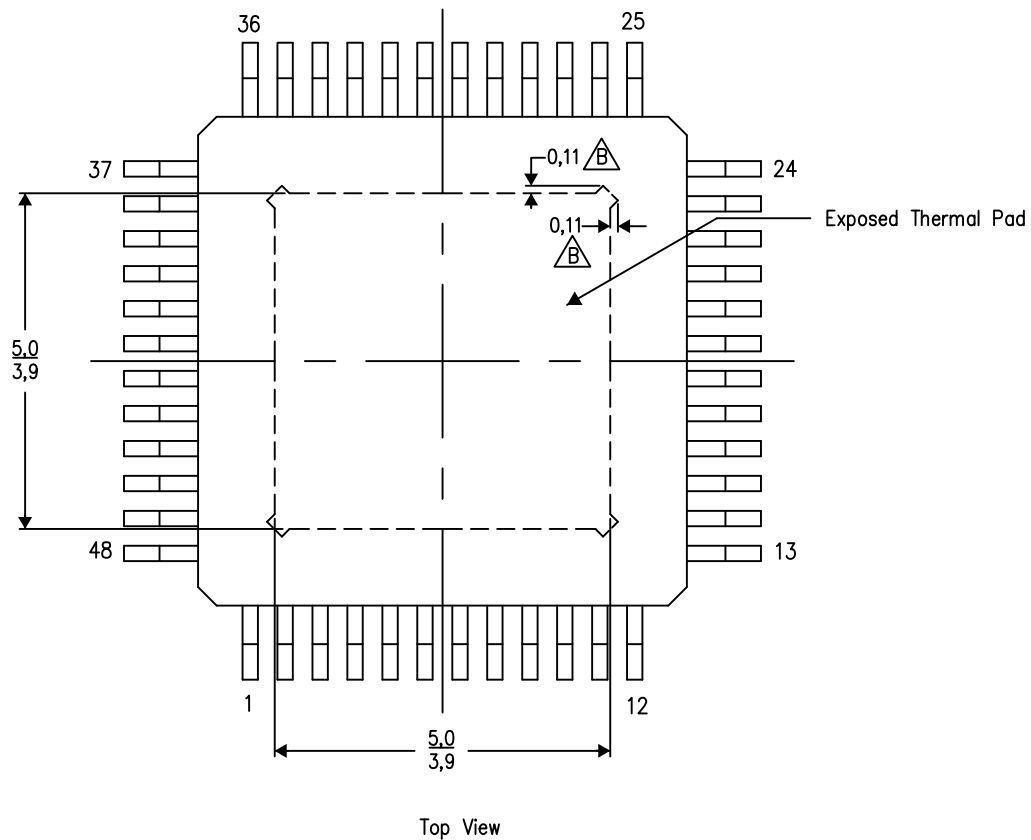

Exposed Thermal Pad Dimensions

4206329-17/P 03/15

NOTE: A. All linear dimensions are in millimeters

 Tie strap features may not be present.

PowerPAD is a trademark of Texas Instruments

PHP (S-PQFP-G48)

PowerPAD™ PLASTIC QUAD FLATPACK

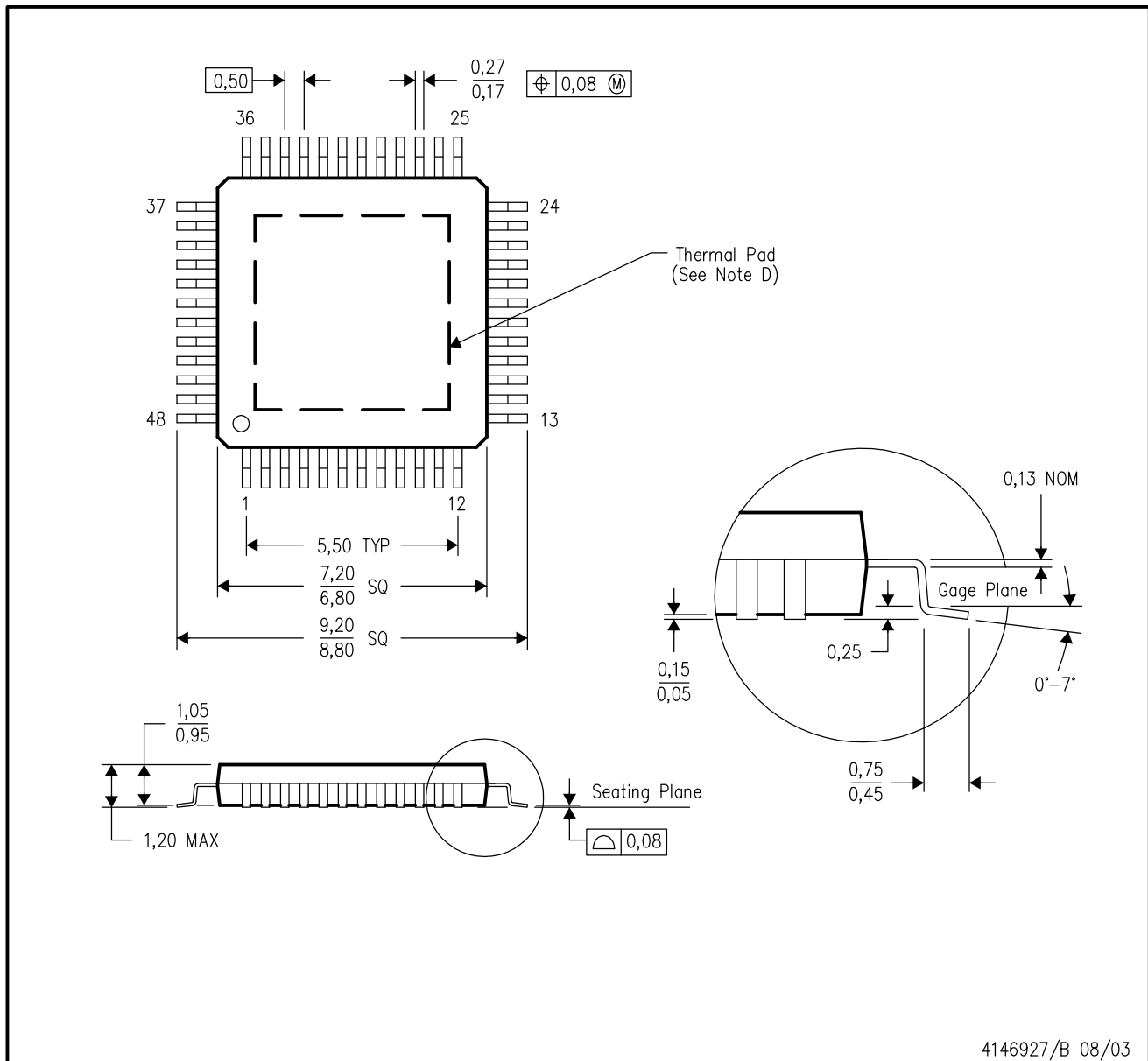

- NOTES:
- All linear dimensions are in millimeters.
 - This drawing is subject to change without notice.
 - Body dimensions do not include mold flash or protrusion.
 - This package is designed to be soldered to a thermal pad on the board. Refer to Technical Brief, PowerPad Thermally Enhanced Package, Texas Instruments Literature No. SLMA002 for information regarding recommended board layout. This document is available at www.ti.com <<http://www.ti.com>>.
 - Falls within JEDEC MS-026

PowerPAD is a trademark of Texas Instruments.

THERMAL PAD MECHANICAL DATA

PHP (S-PQFP-G48)

PowerPAD™ PLASTIC QUAD FLATPACK

THERMAL INFORMATION

This PowerPAD™ package incorporates an exposed thermal pad that is designed to be attached to a printed circuit board (PCB). The thermal pad must be soldered directly to the PCB. After soldering, the PCB can be used as a heatsink. In addition, through the use of thermal vias, the thermal pad can be attached directly to the appropriate copper plane shown in the electrical schematic for the device, or alternatively, can be attached to a special heatsink structure designed into the PCB. This design optimizes the heat transfer from the integrated circuit (IC).

For additional information on the PowerPAD package and how to take advantage of its heat dissipating abilities, refer to Technical Brief, PowerPAD Thermally Enhanced Package, Texas Instruments Literature No. SLMA002 and Application Brief, PowerPAD Made Easy, Texas Instruments Literature No. SLMA004. Both documents are available at www.ti.com.

The exposed thermal pad dimensions for this package are shown in the following illustration.

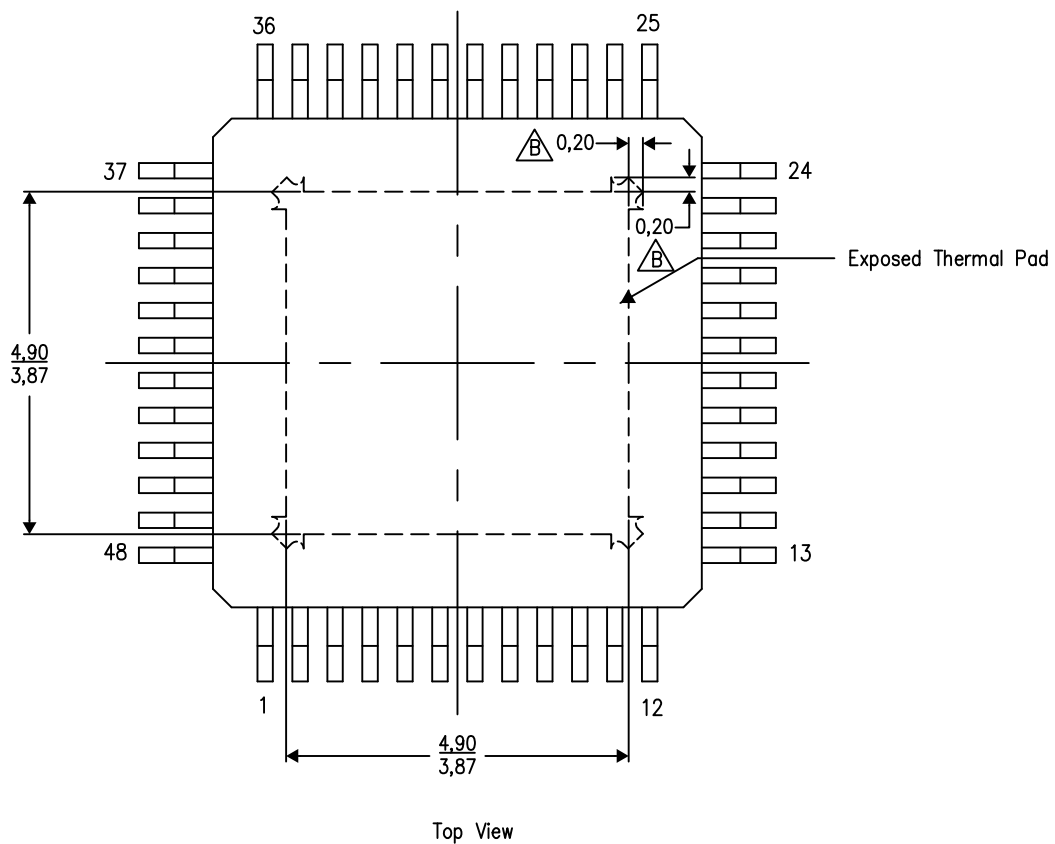

Exposed Thermal Pad Dimensions

4206329-4/P 03/15

NOTE: A. All linear dimensions are in millimeters

 Tie strap features may not be present.

PowerPAD is a trademark of Texas Instruments

PHP (S-PQFP-G48)

PowerPAD™ PLASTIC QUAD FLATPACK

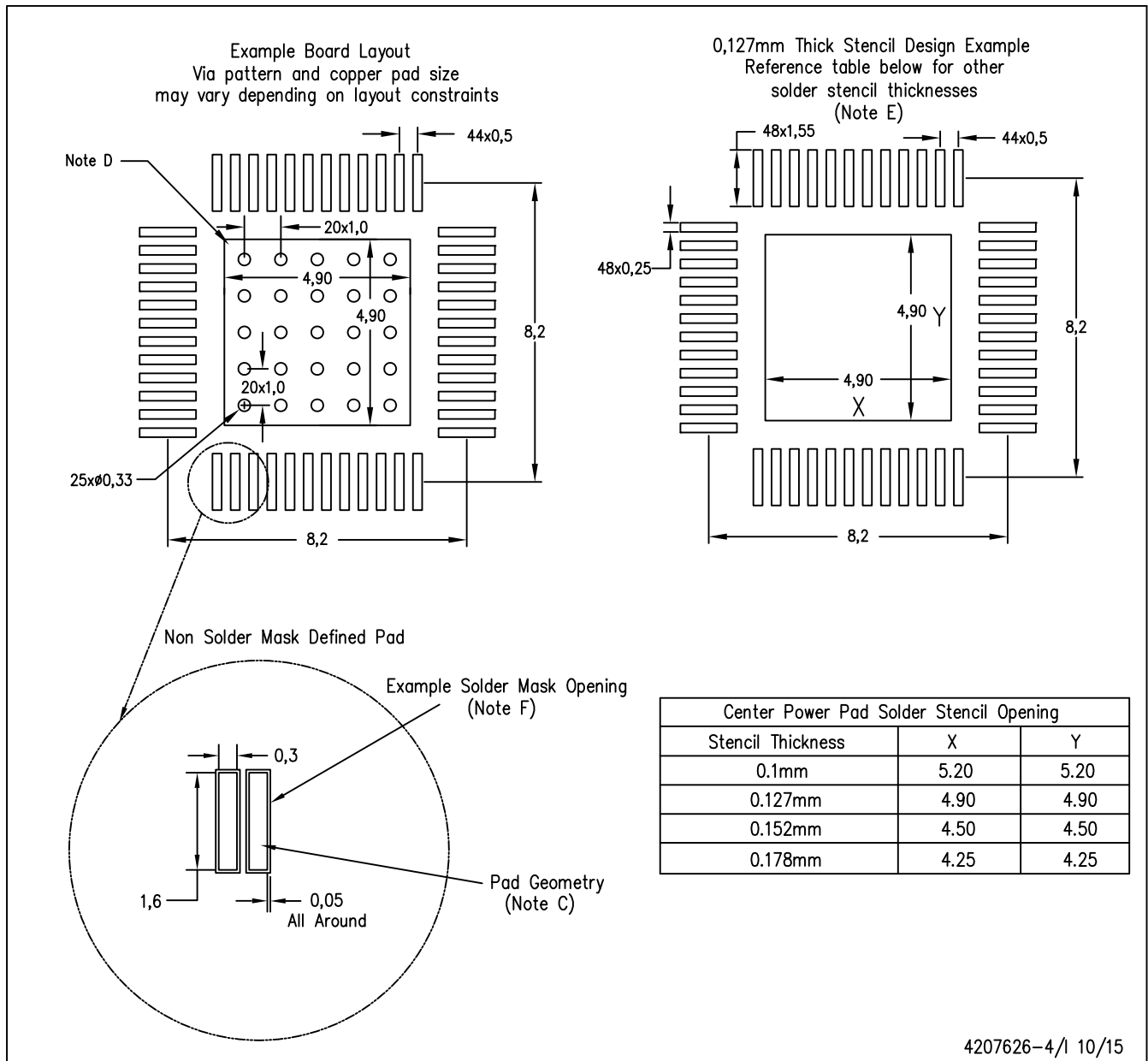

4207626-4/1 10/15

- NOTES:
- A. All linear dimensions are in millimeters.
 - B. This drawing is subject to change without notice.
 - C. Publication IPC-7351 is recommended for alternate designs.
 - D. This package is designed to be soldered to a thermal pad on the board. Refer to Technical Brief, PowerPAD Thermally Enhanced Package, Texas Instruments Literature No. SLMA002, SLMA004, and also the Product Data Sheets for specific thermal information, via requirements, and recommended board layout. These documents are available at www.ti.com <<http://www.ti.com>>.
 - E. Laser cutting apertures with trapezoidal walls and also rounding corners will offer better paste release. Customers should contact their board assembly site for stencil design recommendations. Refer to IPC 7525 for stencil design considerations.
 - F. Customers should contact their board fabrication site for recommended solder mask tolerances and via tenting options for vias placed in the thermal pad.

PowerPAD is a trademark of Texas Instruments

PFB (S-PQFP-G48)

PLASTIC QUAD FLATPACK

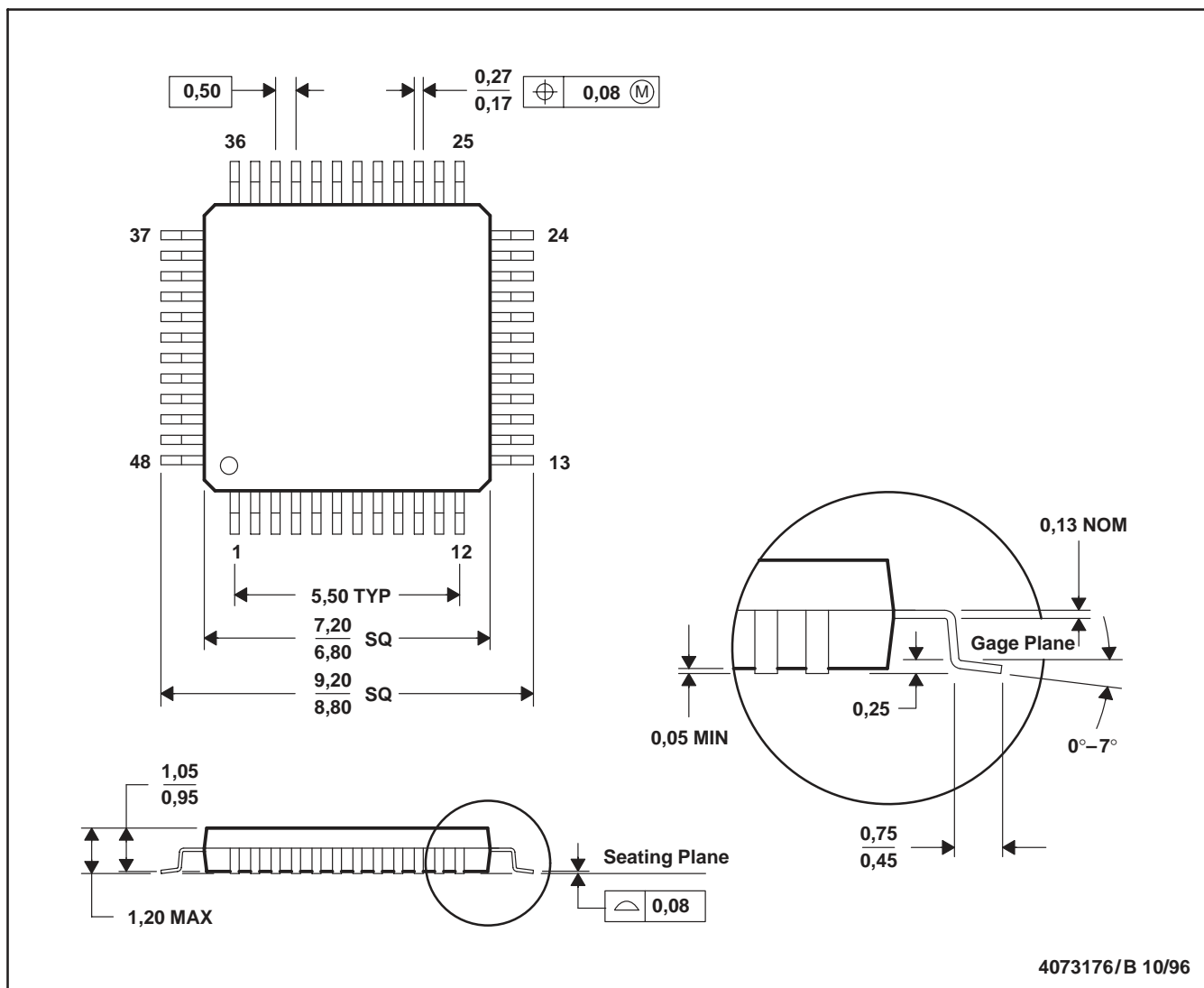

- NOTES: A. All linear dimensions are in millimeters.
 B. This drawing is subject to change without notice.
 C. Falls within JEDEC MS-026

PFB (S-PQFP-G48)

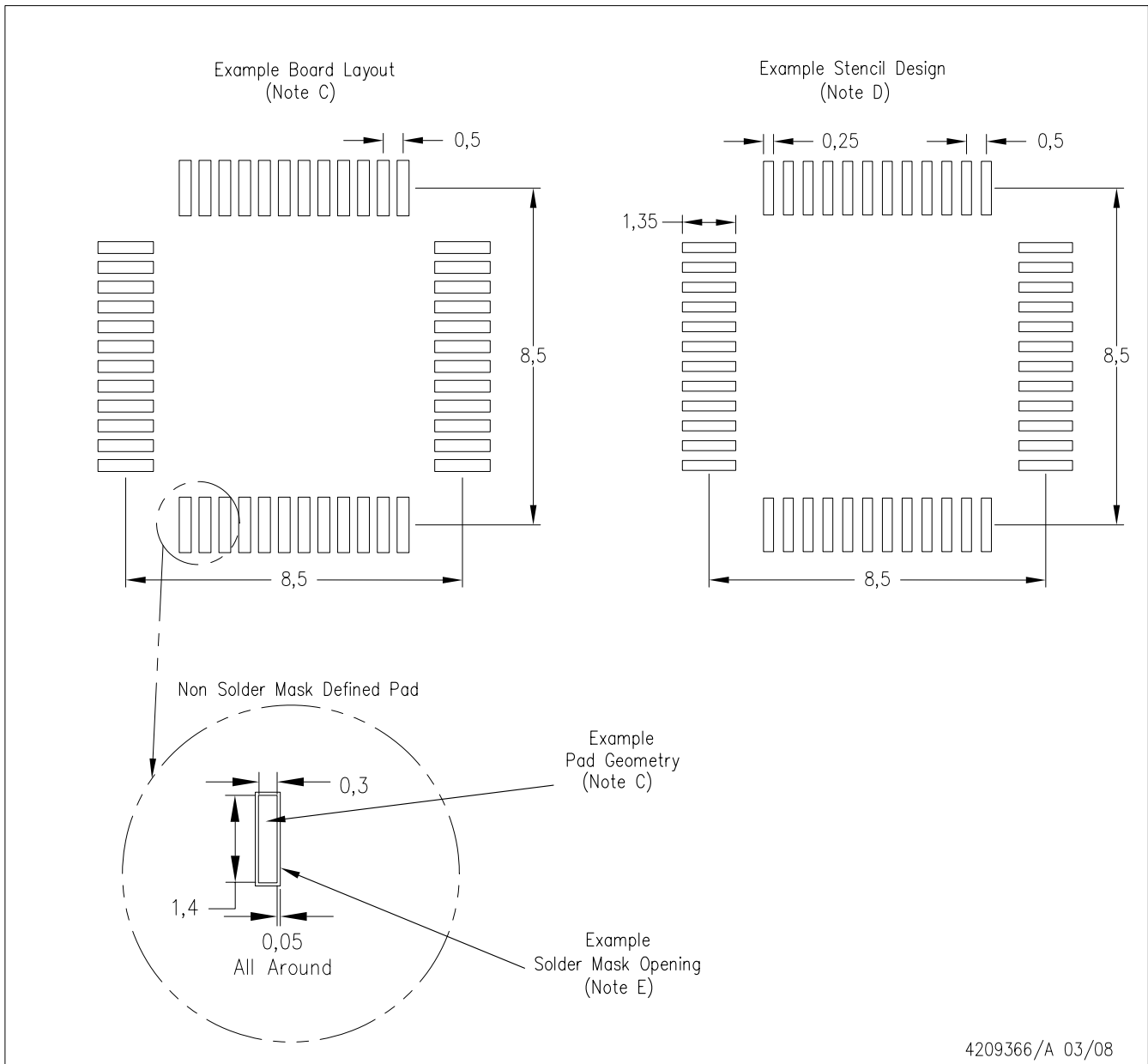

- NOTES:
- A. All linear dimensions are in millimeters.
 - B. This drawing is subject to change without notice.
 - C. Publication IPC-7351 is recommended for alternate designs.
 - D. Laser cutting apertures with trapezoidal walls and also rounding corners will offer better paste release. Customers should contact their board assembly site for stencil design recommendations. Refer to IPC-7525.
 - E. Customers should contact their board fabrication site for solder mask tolerances between and around signal pads.

IMPORTANT NOTICE AND DISCLAIMER

TI PROVIDES TECHNICAL AND RELIABILITY DATA (INCLUDING DATA SHEETS), DESIGN RESOURCES (INCLUDING REFERENCE DESIGNS), APPLICATION OR OTHER DESIGN ADVICE, WEB TOOLS, SAFETY INFORMATION, AND OTHER RESOURCES "AS IS" AND WITH ALL FAULTS, AND DISCLAIMS ALL WARRANTIES, EXPRESS AND IMPLIED, INCLUDING WITHOUT LIMITATION ANY IMPLIED WARRANTIES OF MERCHANTABILITY, FITNESS FOR A PARTICULAR PURPOSE OR NON-INFRINGEMENT OF THIRD PARTY INTELLECTUAL PROPERTY RIGHTS.

These resources are intended for skilled developers designing with TI products. You are solely responsible for (1) selecting the appropriate TI products for your application, (2) designing, validating and testing your application, and (3) ensuring your application meets applicable standards, and any other safety, security, regulatory or other requirements.

These resources are subject to change without notice. TI grants you permission to use these resources only for development of an application that uses the TI products described in the resource. Other reproduction and display of these resources is prohibited. No license is granted to any other TI intellectual property right or to any third party intellectual property right. TI disclaims responsibility for, and you will fully indemnify TI and its representatives against, any claims, damages, costs, losses, and liabilities arising out of your use of these resources.

TI's products are provided subject to [TI's Terms of Sale](#) or other applicable terms available either on ti.com or provided in conjunction with such TI products. TI's provision of these resources does not expand or otherwise alter TI's applicable warranties or warranty disclaimers for TI products.

TI objects to and rejects any additional or different terms you may have proposed.

Mailing Address: Texas Instruments, Post Office Box 655303, Dallas, Texas 75265
Copyright © 2022, Texas Instruments Incorporated