

## Single BiCMOS rail-to-rail micropower comparator

Datasheet - production data

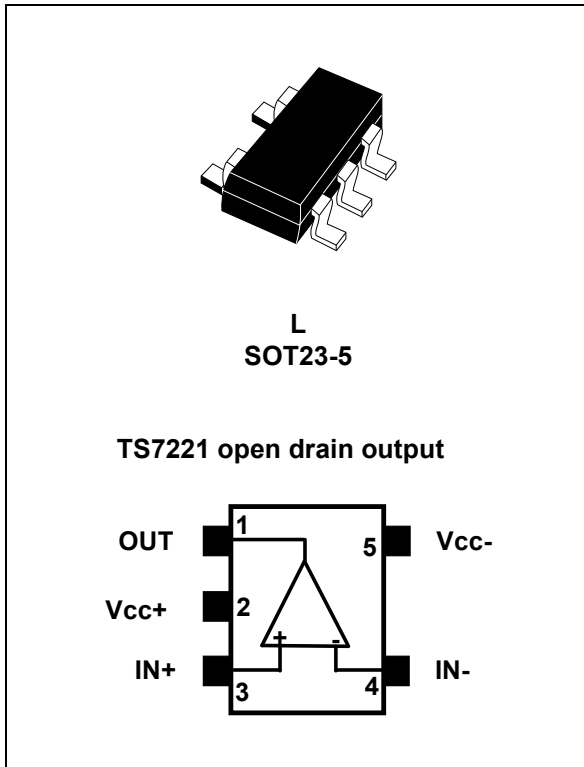

### Applications

- Battery-powered systems
- Notebooks and PDAs
- PCMCIA cards
- Cellular and mobile communications
- Alarms and security systems
- To replace amplifiers used in comparator configurations for improved performance

### Description

The TS7221 is a micropower comparator featuring a rail-to-rail input performance in a tiny SOT23-5 package. This comparator is ideally suited to space and weight-critical applications. It is fully specified at 2.7 V, 5 V and 10 V operation.

The TS7221 features an open-drain output stage. The speed-to-power ratio makes this device ultra-versatile for a wide range of applications.

### Features

- Rail-to-rail inputs
- Open drain output
- Supply operation from 2.7 to 10 V
- Typical supply current: 6  $\mu$ A at 5 V
- Response time of 0.5  $\mu$ s at 5 V
- Low input current
- ESD protection: 2 kV (HBM), 200 V (MM)
- Available in tiny SOT23-5 package

# Contents

<b>1</b>	<b>Absolute maximum ratings</b> .....	<b>3</b>
<b>2</b>	<b>Electrical characteristics</b> .....	<b>4</b>
<b>3</b>	<b>Package information</b> .....	<b>10</b>
	3.1 SOT23-5 package information .....	11
<b>4</b>	<b>Ordering information</b> .....	<b>12</b>
<b>5</b>	<b>Revision history</b> .....	<b>13</b>

# 1 Absolute maximum ratings

**Table 1. Absolute maximum ratings**

Symbol	Parameter	Value	Unit
$V_{CC}$	Supply voltage	12	V
$V_{ID}$	Differential input voltage	$(V_{CC}^-) - 0.3$ to $(V_{CC}^+) + 0.3$	
$V_{IN}$	Input voltage <sup>(1)</sup>		
$V_{OUT}$	Output voltage	12	
$I_{IN}$	Current at input pins <sup>(1)</sup>	$\pm 5$	mA
$I_{OUT}$	Current at output pin	$\pm 30$	
$R_{thja}$	Thermal resistance junction to ambient <sup>(2)</sup> SOT23-5	250	°C/W
$R_{thjc}$	Thermal resistance junction to case <sup>(2)</sup> SOT23-5	81	
$T_{Lead}$	Lead temperature (soldering 10 seconds)	260	°C
$T_{stg}$	Storage temperature	-65 to +150	
$T_J$	Junction temperature	150	
ESD	Human body model (HBM) <sup>(3)</sup>	2000	V
	Machine model (MM) <sup>(4)</sup>	200	

1. The magnitude of input voltages must never exceed 0.3 V beyond the supply voltage.
2. Short-circuits can cause excessive heating. This value is typical.
3. Human body model: a 100 pF capacitor is charged to the specified voltage, then discharged through a 1.5 k $\Omega$  resistor between two pins of the device. This is done for all couples of connected pin combinations while the other pins are floating.
4. Machine model: a 200 pF capacitor is charged to the specified voltage, then discharged directly between two pins of the device with no external series resistor (internal resistor < 5  $\Omega$ ). This is done for all couples of connected pin combinations while the other pins are floating.

**Table 2. Operating conditions**

Symbol	Parameter	Value	Unit
$V_{CC}$	Supply voltage	2.7 to 10	V
$T_{amb}$	Ambient temperature TS7221A1LT and TS7221B1LT TS7221A11LT	-40 to +85 -40 to +105	°C
$V_{icm}$	Common mode input voltage range	$(V_{CC}^-) - 0.3$ to $(V_{CC}^+) + 0.3$	V

## 2 Electrical characteristics

**Table 3. Electrical characteristics at  $V_{CC}^+ = 2.7\text{ V}$ ,  $T_{amb} = 25\text{ °C}$  (unless otherwise specified)<sup>(1)</sup>**

Symbol	Parameter	Min.	Typ.	Max.	Unit
$V_{IO}$	Input offset voltage (full common mode range)				mV
	– TS7221A at $T_{min} \leq T_{amb} \leq T_{max}$			7 10	
	– TS7221B at $T_{min} \leq T_{amb} \leq T_{max}$			15 18	
$\Delta V_{IO}$	Input offset voltage drift with temperature		6		$\mu\text{V}/\text{°C}$
$I_{IB}$	Input bias current <sup>(2)</sup> at $T_{min} \leq T_{amb} \leq T_{max}$		1	300 600	pA
$I_{IO}$	Input offset current <sup>(2)</sup> at $T_{min} \leq T_{amb} \leq T_{max}$		1	150 300	
CMRR	Common-mode rejection ratio ( $0 < V_{icm} < 2.7\text{ V}$ )		65		dB
PSRR	Power supply rejection ratio ( $2.7 < V_{CC} < 10\text{ V}$ )		80		
$A_{VD}$	Voltage gain <sup>(3)</sup>		240		
$V_{icm}$	Input common mode voltage range at $T_{min} \leq T_{amb} \leq T_{max}$	-0.3 0.0		3 2.7	V
$I_{OH}$	High level output voltage ( $I_{N^+} = 0.5\text{ V}$ , $I_{N^-} = 0\text{ V}$ and $OUT = 10\text{ V}$ )		0.1	500	nA
$V_{OL}$	Low level output voltage, $I_{sink} = 5\text{ mA}$ at $T_{min} \leq T_{amb} \leq T_{max}$		0.2	0.35 0.45	V
$I_{CC}$	Supply current				$\mu\text{A}$
	– Output low – Output high		6 8	12 14	
$T_{PLH}$	Response time low to high ( $V_{ic} = 1.35\text{ V}$ , $C_L = 50\text{ pF}$ , $R_L = 10\text{ k}\Omega$ )				
	– Overdrive = 10 mV – Overdrive = 100 mV		1.5 0.6		
$T_{PHL}$	Response time high to low ( $V_{ic} = 1.35\text{ V}$ , $C_L = 50\text{ pF}$ , $R_L = 10\text{ k}\Omega$ )				$\mu\text{s}$
	– Overdrive = 10 mV – Overdrive = 100 mV		1.5 0.5		
$T_F$	Fall time $C_L = 50\text{ pF}$ , $R_L = 5\text{ k}\Omega$ , overdrive = 10 mV		0.3		
$T_R$	Rise time $C_L = 50\text{ pF}$ , $R_L = 5\text{ k}\Omega$ , overdrive = 10 mV		0.3		

- Limits are 100 % production-tested at +25 °C. Behavior at temperature range limits is guaranteed through correlation and by design.
- Maximum values include unavoidable inaccuracies of industrial testing.
- Design evaluation.

Table 4. Electrical characteristics for  $V_{CC}^+ = 5\text{ V}$ ,  $T_{\text{amb}} = 25\text{ °C}$  (unless otherwise specified)<sup>(1)</sup>

Symbol	Parameter	Min.	Typ.	Max.	Unit
$V_{IO}$	Input offset voltage (full common mode range) – TS7221A at $T_{\text{min}} \leq T_{\text{amb}} \leq T_{\text{max}}$ – TS7221B $T_{\text{min}} \leq T_{\text{amb}} \leq T_{\text{max}}$			7 10 15 18	mV
$\Delta V_{IO}$	Input offset voltage drift with temperature		6		$\mu\text{V}/^\circ\text{C}$
$I_{IB}$	Input bias current <sup>(2)</sup> at $T_{\text{min}} \leq T_{\text{amb}} \leq T_{\text{max}}$		1	300 600	pA
$I_{IO}$	Input offset current <sup>(2)</sup> at $T_{\text{min}} \leq T_{\text{amb}} \leq T_{\text{max}}$		1	150 300	
CMRR	Common-mode rejection ratio ( $0 < V_{\text{icm}} < 5\text{ V}$ )		70		dB
PSRR	Power supply rejection ratio ( $2.7 < V_{CC} < 10\text{ V}$ )		80		
$A_{VD}$	Voltage gain <sup>(3)</sup>		240		
$V_{\text{icm}}$	Input common mode voltage range at $T_{\text{min}} \leq T_{\text{amb}} \leq T_{\text{max}}$	-0.3 0.0		5.3 5.0	V
$I_{OH}$	High level output voltage ( $I_{N^+} = 0.5\text{ V}$ , $I_{N^-} = 0\text{ V}$ and $OUT = 10\text{ V}$ )		0.1	500	nA
$V_{OL}$	Low level output voltage, $I_{\text{sink}} = 5\text{ mA}$ at $T_{\text{min}} \leq T_{\text{amb}} \leq T_{\text{max}}$		0.2	0.40 0.55	V
$I_{CC}$	Supply current – Output low – Output high		6 8	12 14	$\mu\text{A}$
$T_{PLH}$	Response time low to high ( $V_{\text{ic}} = 2.5\text{ V}$ , $C_L = 50\text{ pF}$ , $R_L = 10\text{ k}\Omega$ ) – Overdrive = 10 mV – Overdrive = 100 mV		2 0.5		$\mu\text{s}$
$T_{PHL}$	Response time high to low ( $V_{\text{ic}} = 2.5\text{ V}$ , $C_L = 50\text{ pF}$ , $R_L = 10\text{ k}\Omega$ ) – Overdrive = 10 mV – Overdrive = 100 mV		2 0.4		
$T_F$	Fall time $C_L = 50\text{ pF}$ , $R_L = 5\text{ k}\Omega$ , overdrive = 10 mV		0.3		
$T_R$	Rise time $C_L = 50\text{ pF}$ , $R_L = 5\text{ k}\Omega$ , overdrive = 10 mV		0.3		

1. Limits are 100% production-tested at +25 °C. Behavior at temperature range limits is guaranteed through correlation and by design.
2. Maximum values include unavoidable inaccuracies of industrial testing.
3. Design evaluation.

Table 5. Electrical characteristics for  $V_{CC}^+ = 10\text{ V}$ ,  $T_{amb} = 25\text{ °C}$  (unless otherwise specified)<sup>(1)</sup>

Symbol	Parameter	Min.	Typ.	Max.	Unit
$V_{IO}$	Input offset voltage (full common mode range)				
	– TS7221A at $T_{min} \leq T_{amb} \leq T_{max}$ – TS7221B $T_{min} \leq T_{amb} \leq T_{max}$			7 10 15 18	mV
$\Delta V_{IO}$	Input offset voltage drift with temperature		6		$\mu\text{V}/\text{°C}$
$I_{IB}$	Input bias current <sup>(2)</sup> at $T_{min} \leq T_{amb} \leq T_{max}$		1	300 600	pA
$I_{IO}$	Input offset current <sup>(2)</sup> at $T_{min} \leq T_{amb} \leq T_{max}$		1	150 300	
CMRR	Common-mode rejection ratio ( $0 < V_{icm} < 10\text{ V}$ )		75		dB
PSRR	Power supply rejection ratio ( $2.7 < V_{CC} < 10\text{ V}$ )		80		
$A_{VD}$	Voltage gain <sup>(3)</sup>		240		
$V_{ICM}$	Input common mode voltage range at $T_{min} \leq T_{amb} \leq T_{max}$	-0.3 0.0		10.3 10.0	V
$I_{OH}$	High level output voltage ( $I_N^+ = 0.5\text{ V}$ , $I_N^- = 0\text{ V}$ and $O_{UT} = 10\text{ V}$ )		0.1	500	nA
$V_{OL}$	Low level output voltage, $I_{sink} = 5\text{ mA}$ at $T_{min} \leq T_{amb} \leq T_{max}$		0.2	0.40 0.55	V
$I_{CC}$	Supply current				$\mu\text{A}$
	– Output low – Output high		7 10	14 16	
$T_{PLH}$	Response time low to high ( $V_{ic} = 5\text{ V}$ , $C_L = 50\text{ pF}$ , $R_L = 10\text{ k}\Omega$ ) – Overdrive = 10 mV – Overdrive = 100 mV				$\mu\text{s}$
			3 0.5		
$T_{PHL}$	Response time high to low ( $V_{ic} = 5\text{ V}$ , $C_L = 50\text{ pF}$ , $R_L = 10\text{ k}\Omega$ ) – Overdrive = 10 mV – Overdrive = 100 mV				
			4 0.4		
$T_F$	Fall time $C_L = 50\text{ pF}$ , $R_L = 5\text{ k}\Omega$ , overdrive = 10 mV		0.3		
$T_R$	Rise time $C_L = 50\text{ pF}$ , $R_L = 5\text{ k}\Omega$ , overdrive = 10 mV		0.3		

1. Limits are 100% production-tested at +25 °C. Behavior at temperature range limits is guaranteed through correlation and by design.
2. Maximum values include unavoidable inaccuracies of industrial testing.
3. Design evaluation.

Figure 1. Supply current vs. supply voltage (output low)

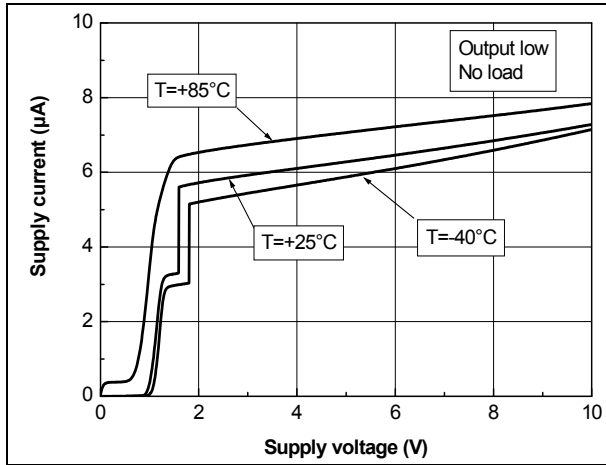

Figure 2. Supply current vs. supply voltage (output high)

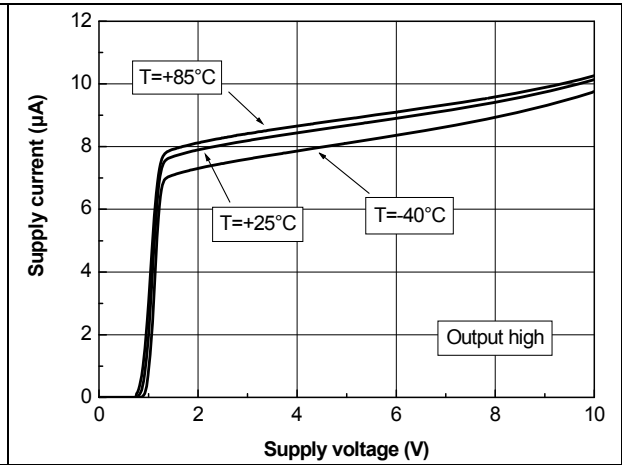

Figure 3. Output sinking current vs. output voltage at  $V_{CC} = +2.7\text{ V}$ ,  $V_{CC} = +5\text{ V}$

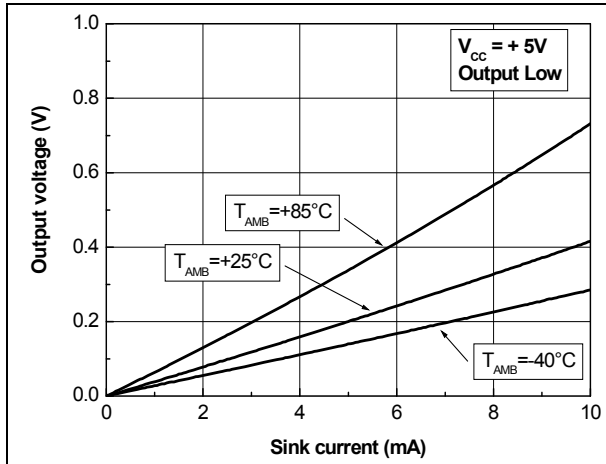

Figure 4.  $V_{IO}$  vs.  $V_{ICM}$  and temperature at  $V_{CC} = 2.7\text{ V}$

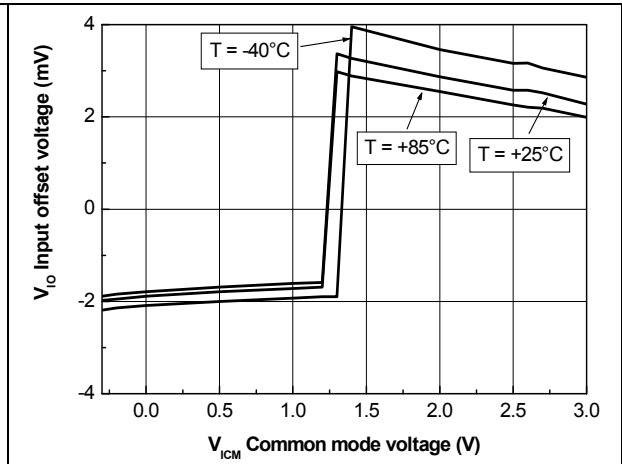

Figure 5.  $V_{IO}$  vs.  $V_{ICM}$  and temperature at  $V_{CC} = 5\text{ V}$

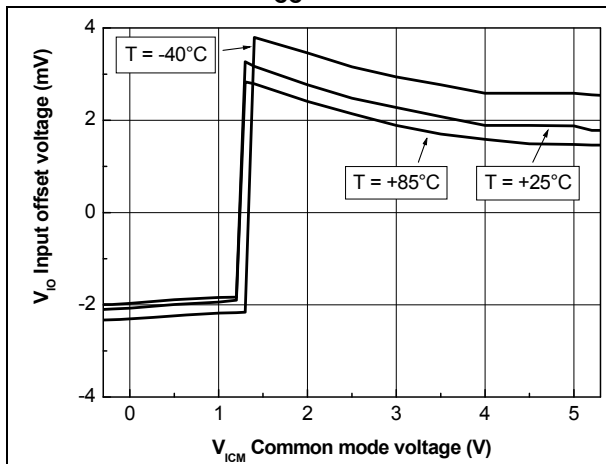

Figure 6.  $V_{IO}$  vs.  $V_{ICM}$  and temperature at  $V_{CC} = 10\text{ V}$

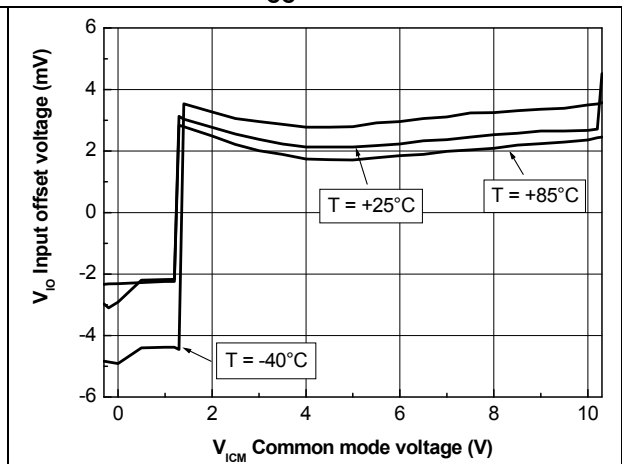

Figure 7.  $T_{PLH}$  vs  $V_{icm}$  at  $V_{CC} = 10\text{ V}$  and 10 mV overdrive

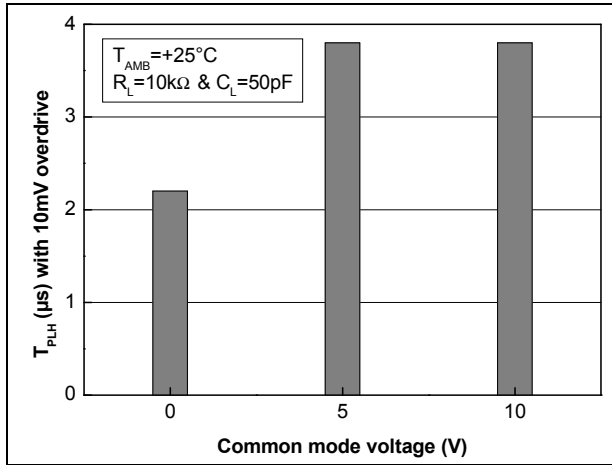

Figure 8.  $T_{PLH}$  vs  $V_{icm}$  at  $V_{CC} = 10\text{ V}$  and 100 mV overdrive

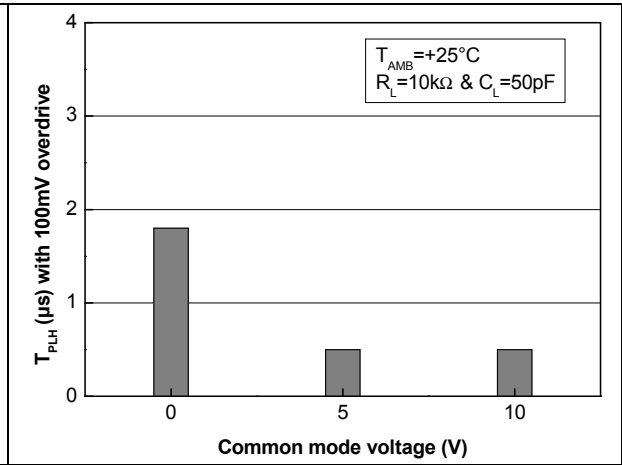

Figure 9.  $T_{PLH}$  vs  $V_{icm}$  at  $V_{CC} = 5\text{ V}$  and 10 mV overdrive

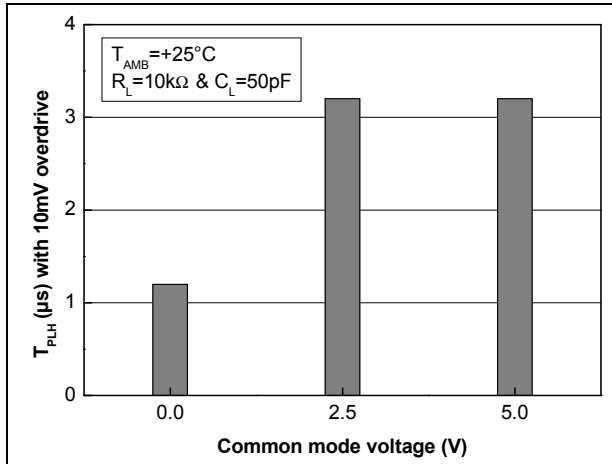

Figure 10.  $T_{PLH}$  vs  $V_{icm}$  at  $V_{CC} = 5\text{ V}$  and 100 mV overdrive

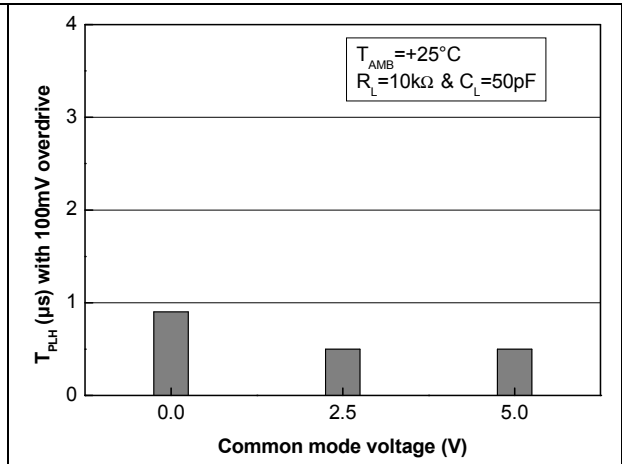

Figure 11.  $T_{PHL}$  vs  $V_{icm}$  at  $V_{CC} = 10\text{ V}$  and 10 mV overdrive

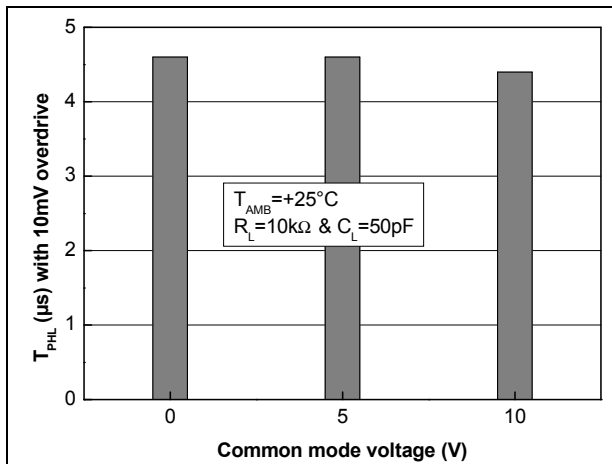

Figure 12.  $T_{PHL}$  vs  $V_{icm}$  at  $V_{CC} = 10\text{ V}$  and 100 mV overdrive

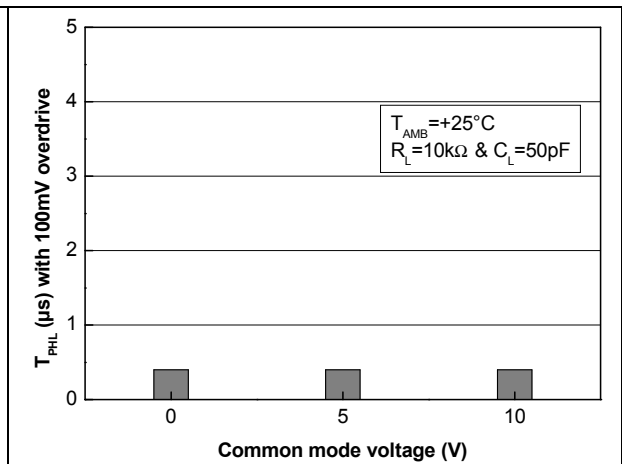
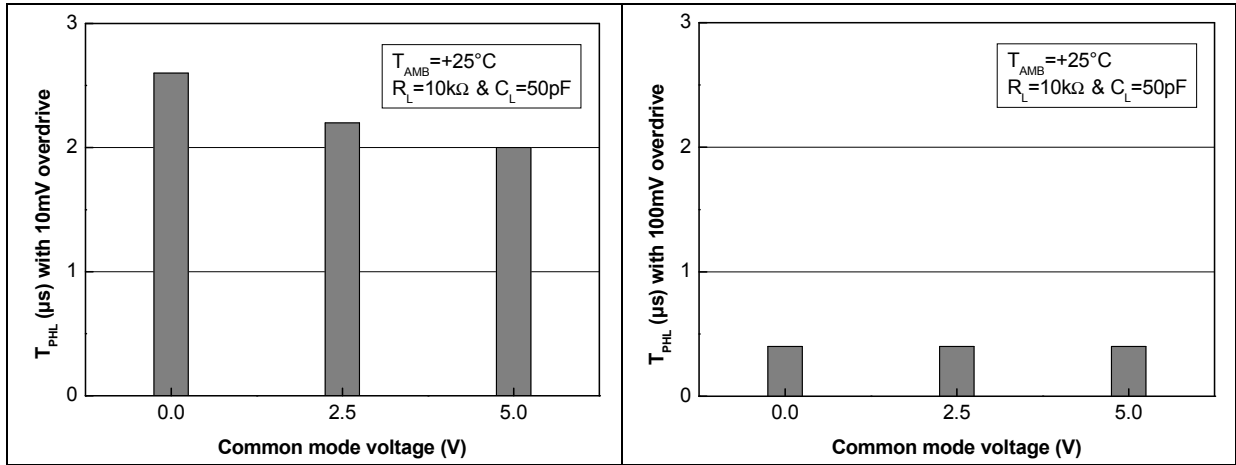



Figure 13.  $T_{PHL}$  vs  $V_{icm}$  at  $V_{CC} = 5\text{ V}$  and  $10\text{ mV}$  overdrive  
 Figure 14.  $T_{PHL}$  vs  $V_{icm}$  at  $V_{CC} = 5\text{ V}$  and  $100\text{ mV}$  overdrive



### 3 Package information

In order to meet environmental requirements, ST offers these devices in different grades of ECOPACK<sup>®</sup> packages, depending on their level of environmental compliance. ECOPACK<sup>®</sup> specifications, grade definitions and product status are available at: [www.st.com](http://www.st.com). ECOPACK<sup>®</sup> is an ST trademark.

### 3.1 SOT23-5 package information

Figure 15. SOT23-5 package mechanical drawing

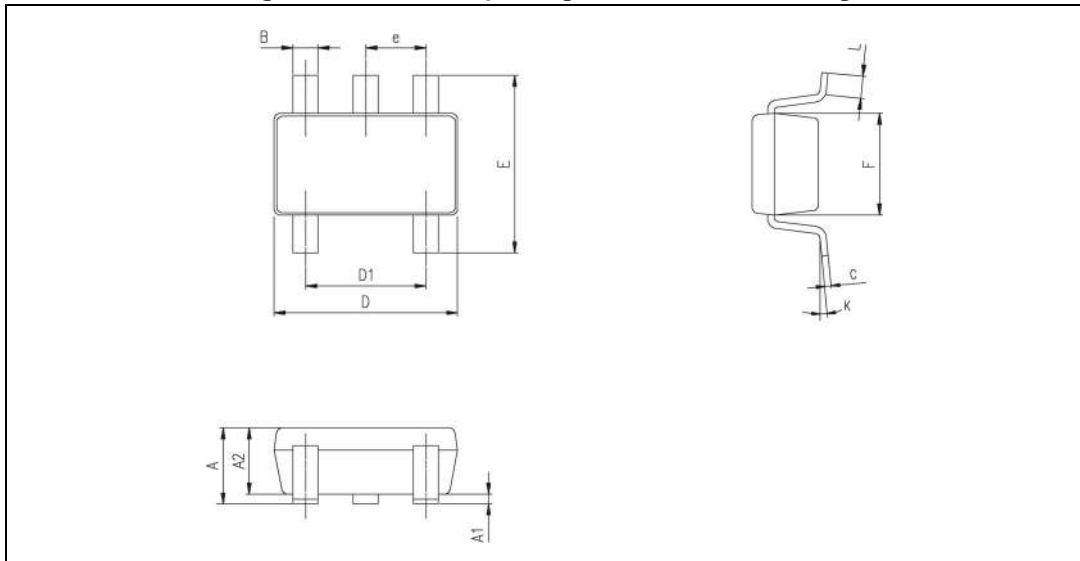

Table 6. SOT23-5 package mechanical data

Ref.	Dimensions					
	Millimeters			Inches		
	Min.	Typ.	Max.	Min.	Typ.	Max.
A	0.90	1.20	1.45	0.035	0.047	0.057
A1			0.15			0.006
A2	0.90	1.05	1.30	0.035	0.041	0.051
B	0.35	0.40	0.50	0.013	0.015	0.019
C	0.09	0.15	0.20	0.003	0.006	0.008
D	2.80	2.90	3.00	0.110	0.114	0.118
D1		1.90			0.075	
e		0.95			0.037	
E	2.60	2.80	3.00	0.102	0.110	0.118
F	1.50	1.60	1.75	0.059	0.063	0.069
L	0.10	0.35	0.60	0.004	0.013	0.023
K	0 degrees		10 degrees	0 degrees		10 degrees

## 4 Ordering information

Table 7. Order codes

Order code	Temperature range	Package	Packing	Marking
TS7221A1LT	-40 °C, 85 °C	SOT23-5	Tape and reel	K518
TS7221B1LT				K519
TS7221A11LT	-40 °C, 105 °C			K525

## 5 Revision history

**Table 8. Document revision history**

Date	Revision	Changes
01-Dec-2002	1	Initial release
01-Sep-2005	2	Update of datasheet presentation and format. Change of $T_{lead}$ temperature in <a href="#">Table 1 on page 3</a> , to reflect change to Pb-free package. Corrections to $V_{icm}$ upper rail parameters in <a href="#">Electrical characteristics</a> tables. Addition of Pb-free information in <a href="#">Section 3: Package information on page 10</a> . Correction to package mechanical data given in <a href="#">Figure 15 on page 11</a> .
26-Mar-2007	3	Added automotive grade part numbers in <a href="#">Section 4: Ordering information on page 12</a> .
05-Jul-2007	4	Corrected automotive grade part numbers in <a href="#">Table 7: Order codes</a> .
27-Mar-2009	5	Added notes for ESD in <a href="#">Table 1: Absolute maximum ratings</a> . Added $R_{thja}$ and $R_{thjc}$ parameters in <a href="#">Table 1: Absolute maximum ratings</a> . Removed power dissipation parameter ( $P_D$ ) in <a href="#">Table 1: Absolute maximum ratings</a> . Updated package information in <a href="#">Section 3.1</a> . Removed automotive grade part numbers in <a href="#">Table 7: Order codes</a> .
01-Apr-2014	6	<a href="#">Description</a> : removed industrial temperature range <a href="#">Table 2: Operating conditions</a> : updated values for $T_{amb}$ <a href="#">Table 7: Order codes</a> ; added order code TS7221A11LT Removed "L" from SOT23-5 package name

**Please Read Carefully:**

Information in this document is provided solely in connection with ST products. STMicroelectronics NV and its subsidiaries ("ST") reserve the right to make changes, corrections, modifications or improvements, to this document, and the products and services described herein at any time, without notice.

All ST products are sold pursuant to ST's terms and conditions of sale.

Purchasers are solely responsible for the choice, selection and use of the ST products and services described herein, and ST assumes no liability whatsoever relating to the choice, selection or use of the ST products and services described herein.

No license, express or implied, by estoppel or otherwise, to any intellectual property rights is granted under this document. If any part of this document refers to any third party products or services it shall not be deemed a license grant by ST for the use of such third party products or services, or any intellectual property contained therein or considered as a warranty covering the use in any manner whatsoever of such third party products or services or any intellectual property contained therein.

**UNLESS OTHERWISE SET FORTH IN ST'S TERMS AND CONDITIONS OF SALE ST DISCLAIMS ANY EXPRESS OR IMPLIED WARRANTY WITH RESPECT TO THE USE AND/OR SALE OF ST PRODUCTS INCLUDING WITHOUT LIMITATION IMPLIED WARRANTIES OF MERCHANTABILITY, FITNESS FOR A PARTICULAR PURPOSE (AND THEIR EQUIVALENTS UNDER THE LAWS OF ANY JURISDICTION), OR INFRINGEMENT OF ANY PATENT, COPYRIGHT OR OTHER INTELLECTUAL PROPERTY RIGHT.**

**ST PRODUCTS ARE NOT DESIGNED OR AUTHORIZED FOR USE IN: (A) SAFETY CRITICAL APPLICATIONS SUCH AS LIFE SUPPORTING, ACTIVE IMPLANTED DEVICES OR SYSTEMS WITH PRODUCT FUNCTIONAL SAFETY REQUIREMENTS; (B) AERONAUTIC APPLICATIONS; (C) AUTOMOTIVE APPLICATIONS OR ENVIRONMENTS, AND/OR (D) AEROSPACE APPLICATIONS OR ENVIRONMENTS. WHERE ST PRODUCTS ARE NOT DESIGNED FOR SUCH USE, THE PURCHASER SHALL USE PRODUCTS AT PURCHASER'S SOLE RISK, EVEN IF ST HAS BEEN INFORMED IN WRITING OF SUCH USAGE, UNLESS A PRODUCT IS EXPRESSLY DESIGNATED BY ST AS BEING INTENDED FOR "AUTOMOTIVE, AUTOMOTIVE SAFETY OR MEDICAL" INDUSTRY DOMAINS ACCORDING TO ST PRODUCT DESIGN SPECIFICATIONS. PRODUCTS FORMALLY ESCC, QML OR JAN QUALIFIED ARE DEEMED SUITABLE FOR USE IN AEROSPACE BY THE CORRESPONDING GOVERNMENTAL AGENCY.**

Resale of ST products with provisions different from the statements and/or technical features set forth in this document shall immediately void any warranty granted by ST for the ST product or service described herein and shall not create or extend in any manner whatsoever, any liability of ST.

ST and the ST logo are trademarks or registered trademarks of ST in various countries.

Information in this document supersedes and replaces all information previously supplied.

The ST logo is a registered trademark of STMicroelectronics. All other names are the property of their respective owners.

© 2014 STMicroelectronics - All rights reserved

STMicroelectronics group of companies

Australia - Belgium - Brazil - Canada - China - Czech Republic - Finland - France - Germany - Hong Kong - India - Israel - Italy - Japan - Malaysia - Malta - Morocco - Philippines - Singapore - Spain - Sweden - Switzerland - United Kingdom - United States of America

[www.st.com](http://www.st.com)