

8A, 23V, 500kHz Synchronous Step-Down Converter with 3.3V/5V LDO

General Description

The RT7238B/C/D/E is an advanced constant on-time (ACOT™) mode synchronous step-down converter. The main control loop of RT7238B/C/D/E using an advanced constant on-time (ACOT™) mode control which provides a very fast transient response. The RT7238B/C/D/E operates from 8V to 23V input voltage. For the RT7238D, the output voltage can be adjusted between 0.6V to 5V.

Ordering Information

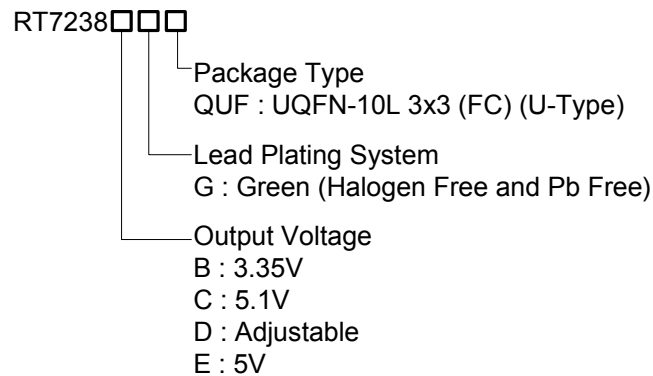

Note :

Richtek products are :

- ▶ RoHS compliant and compatible with the current requirements of IPC/JEDEC J-STD-020.
- ▶ Suitable for use in SnPb or Pb-free soldering processes.

Features

- Advanced Constant On-Time (ACOT) Control
- 8V to 23V (RT7238B/C/D/E) Input Voltage Range @ 8A Output Current
- ACOT™ Mode Performs Fast Transient Response
- ACOT™ Architecture to Enable all MLCC Output Capacitor Usage
- Fixed 500kHz Switching Frequency
- High Efficient Internal Power MOSFET Switch
 - ▶ 27mΩ (High-Side) and 10mΩ (Low-Side)
- Adjustable Output Voltage from 0.6V to 5V (RT7238D)
- Fixed 3.3V (RT7238B/D) or 5V (RT7238C/E) LDO Output Supplies 70mA
- Pre-biased Soft-Start
- Cycle-by-Cycle Over-Current Protection
- Input Under-Voltage Lockout
- Thermal Shutdown
- Output Over/Under-Voltage Protection

Applications

- Industrial and Commercial Low Power Systems
- Computer Peripherals
- LCD Monitors and TVs
- Green Electronics/Appliances
- Point of Load Regulation for High-Performance DSPs, FPGAs, and ASICs

Simplified Application Circuit

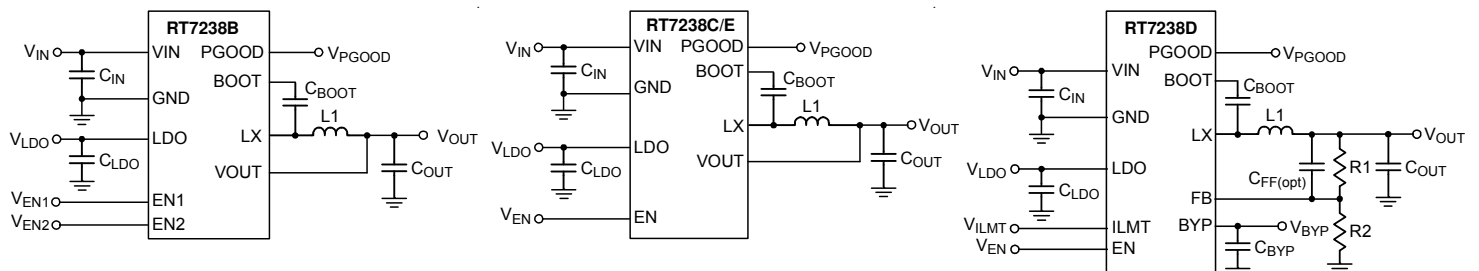

Marking Information

RT7238BGQUF

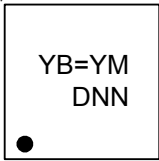

YB= : Product Code
YMDNN : Date Code

RT7238CGQUF

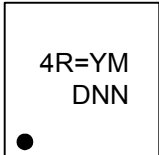

4R= : Product Code
YMDNN : Date Code

RT7238DGQUF

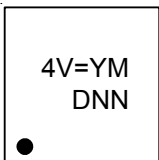

4V= : Product Code
YMDNN : Date Code

RT7238EGQUF

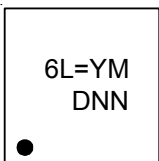

6L= : Product Code
YMDNN : Date Code

Pin Configuration

(TOP VIEW)

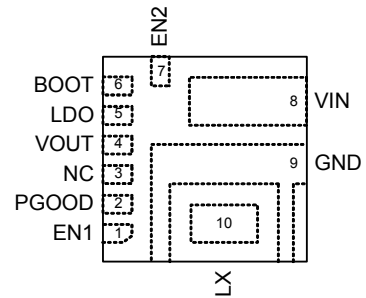

RT7238B

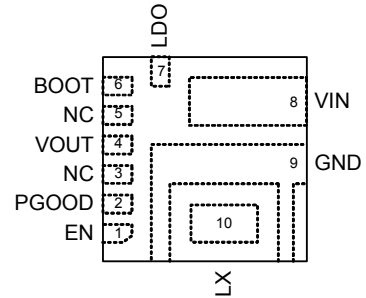

RT7238C/E

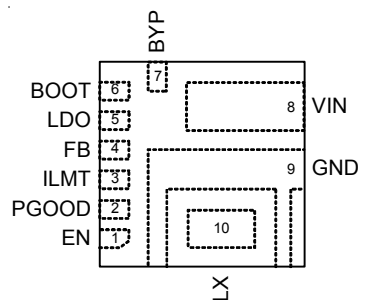

RT7238D

UQFN-10L 3x3 (FC)

Part Status

Part No	Status	Package	Lead Plating System
RT7238BGQUF	Lifebuy	UQFN-10L 3x3 (FC) (U-Type)	G : Green (Halogen Free and Pb Free)

The part status values are defined as below :

Active : Device is in production and is recommended for new designs.

Lifebuy : The device will be discontinued, and a lifetime-buy period is in effect.

NRND : Not recommended for new designs.

Preview : Device has been announced but is not in production.

EOL: Richtek has discontinued the production of the device.

Functional Pin Description

RT7238B

Pin No.	Pin Name	Pin Function
1	EN1	Enable Control Input of the DC/DC Regulator. Pull this pin high to turn on the regulator. Do not leave this pin floating.
2	PGOOD	Power Good Indicator. Open-drain output when the output voltage is within 91% to 120% of regulation point.
3	NC	No Internal Connection.
4	VOUT	Output. Connect to the Output of DC/DC Regulator. The pin also provide the bypass input for internal LDO.
5	LDO	Internal 3.3V LDO Output. Power supply for internal analog circuits and driving circuit. Bypass a 2.2 μ F capacitor to GND. This pin is also capable of sourcing 70mA current for external load.
6	BOOT	Bootstrap Supply for High-Side Gate Driver. Decouple this pin to LX pin with a 0.1 μ F ceramic capacitor.
7	EN2	Enable Control Input of the IC and Internal LDO. Pull this pin high to turn on the IC and internal LDO. Do not leave this pin floating.
8	VIN	Power Input. Decouple this pin to GND pin with a at least 10 μ F ceramic capacitor.
9	GND	Ground.
10	LX	Switch Node. Connect this pin to the external inductor.

RT7238C/E

Pin No.	Pin Name	Pin Function
1	EN	Enable Control of the DC/DC Regulator. Pull this pin high to turn on the regulator. Do not leave this pin floating.
2	PGOOG	Power Good Indicator. Open-drain output when the output voltage is within 91% to 120% of regulation point.
3, 5	NC	No Internal Connection.
4	VOUT	Output. Connect to the output of DC/DC regulator. The pin also provide the bypass input for internal LDO.
6	BOOT	Bootstrap Supply for High-Side Gate Driver. Decouple this pin to LX pin with a 0.1 μ F ceramic capacitor.
7	LDO	Internal 5V LDO Output. Power supply for internal analog circuits and driving circuit. Bypass a 2.2 μ F capacitor to GND. This pin is also capable of sourcing 70mA current for external load.
8	VIN	Power Input. Decouple this pin to GND pin with a at least 10 μ F ceramic cap.
9	GND	Ground.
10	LX	Switch Node. Connect this pin to the external inductor.

RT7238D

Pin No.	Pin Name	Pin Function
1	EN	Enable Control Input. Pull this pin high to turn on the IC. Do not leave this pin floating.
2	PGOOD	Power Good Indicator. Open-drain output when the output voltage is within 91% to 120% of regulation point.
3	ILMT	Current Limit Setting. The current limit is set to 8A, 12A or 16A when this pin is pulled low, floating or pulled high, respectively.
4	FB	Feedback Voltage Input. Connect this pin to the center point of the output resistor divider to program the output voltage.
5	LDO	Internal 3.3V LDO Output. Power supply for internal analog circuits and driving circuit. Bypass a 2.2 μ F capacitor to GND. This pin is also capable sourcing 70mA current for external load.
6	BOOT	Decouple this pin to LX pin with a 0.1 μ F Ceramic Capacitor.
7	BYP	Bypass Input for the Internal LDO. BYP is externally connected to the output of switching regulator. When the BYP voltage rises above the bypass switch turn-on threshold, the LDO regulator shuts down and the LDO pin is connected to the BYP pin through an internal switch.
8	VIN	Power Input. Decouple this pin to GND with a at least 10 μ F ceramic capacitor.
9	GND	Ground.
10	LX	Switch Node. Connect this pin to the external inductor.

Function Block Diagram

RT7238B

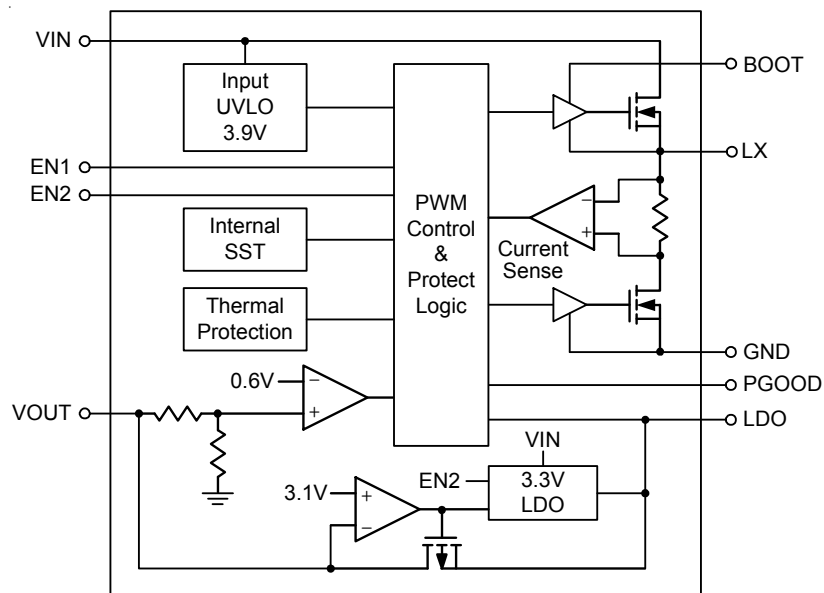

RT7238C/E

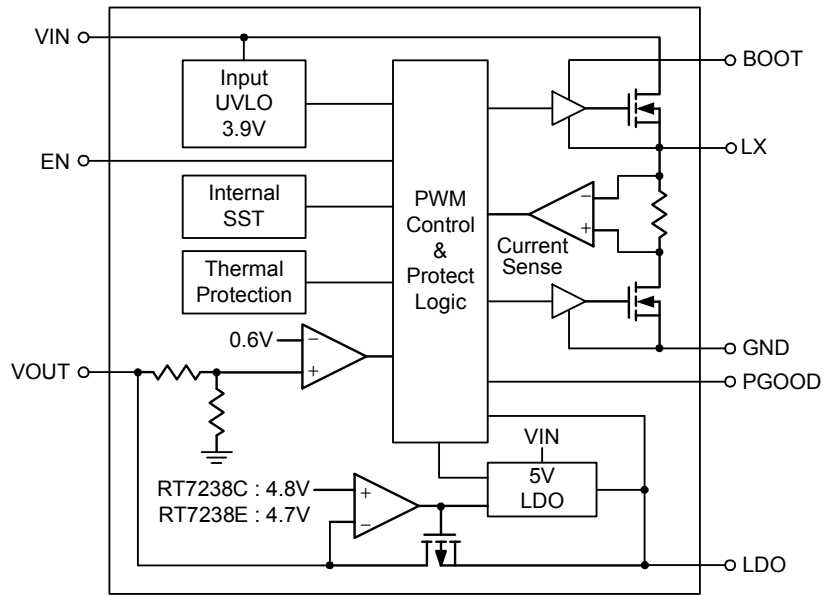

RT7238D

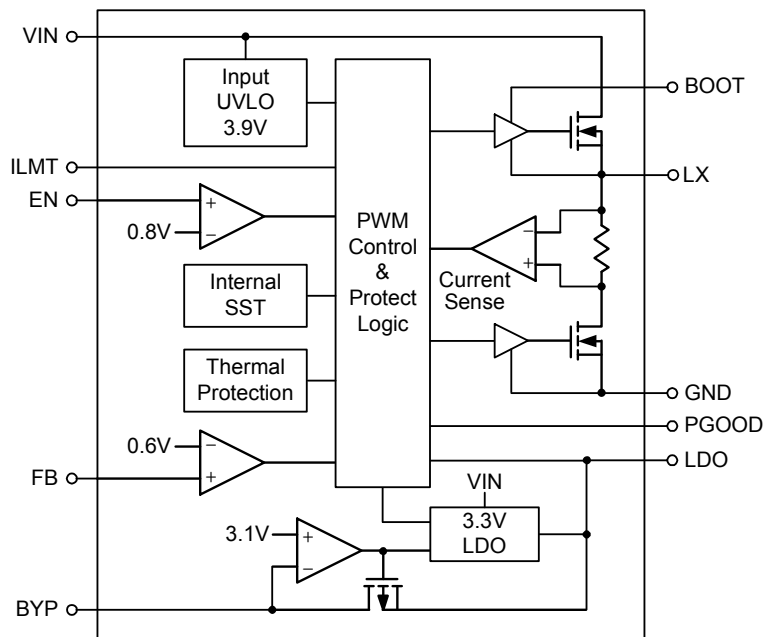

Absolute Maximum Ratings (Note 1)

- Supply Voltage, V_{IN} ----- -0.3V to 27V
- Enable Pin Voltage, $V_{EN, EN1, EN2}$ ----- -0.3V to 27V
- Switch Voltage, V_{LX} ----- -0.3V to ($V_{IN} + 0.3V$)
- < 30ns ----- -5V to 28V
- Boot Voltage, V_{BOOT} ----- ($V_{LX} - 0.3V$) to ($V_{LX} + 6V$)
- Other I/O Pin Voltages ----- -0.3V to 6 V
- Power Dissipation, $P_D @ T_A = 25^\circ C$
- UQFN-10L 3x3 (FC) ----- 3.33W
- Package Thermal Resistance (Note 2)
- UQFN-10L 3x3 (FC), θ_{JA} ----- 30°C/W
- Junction Temperature ----- 150°C
- Lead Temperature (Soldering, 10 sec.) ----- 260°C
- Storage Temperature Range ----- -65°C to 150°C
- ESD Susceptibility (Note 3)
- HBM (Human Body Model) ----- 2kV

Recommended Operating Conditions (Note 4)

- Supply Input Voltage, V_{IN} (RT7238B/C/D/E) ----- 8V to 23V
- Junction Temperature Range ----- -40°C to 125°C
- Ambient Temperature Range ----- -40°C to 85°C

Electrical Characteristics

($V_{IN} = 12V, T_A = 25^\circ C$, unless otherwise specified)

Parameter	Symbol	Test Conditions	Min	Typ	Max	Unit
Supply Current						
Supply Current (Shutdown)	ISHDN	$V_{EN1} = 0, V_{EN2} = 0$ (RT7238B)	--	5	15	μA
		$V_{EN} = 0$ (RT7238D)	--	5	15	
		$V_{EN} = 0$ (RT7238C/E)	--	35	45	
Supply Current (Quiescent)	IQ	$I_{OUT} = 0, V_{OUT} = 3.35V \times 105\%$ $V_{EN1} = V_{EN2} = 2V$ (RT7238B)	--	--	110	μA
		$I_{OUT} = 0, V_{FB} = V_{REF} \times 105\%$ $V_{EN} = 2V$ (RT7238D)	--	--	110	
		$I_{OUT} = 0, V_{OUT} = 5.1V \times 105\%$ $V_{EN} = 2V$ (RT7238C/E)	--	--	110	
Logic Threshold						
EN Input Voltage	Logic-High	V_{IH}	0.8	--	--	V
	Logic-Low	V_{IL}	--	--	0.3	
EN Input Current	IEN	$V_{EN} > 4.5V$	--	140	--	μA
		$V_{EN} \leq 4.5V$	--	1	--	
Output Voltage						
Output Voltage Setpoint	VOUT	(RT7238B)	3.316	3.35	3.383	V
		(RT7238C)	5.049	5.1	5.151	
		(RT7238E)	4.95	5	5.05	

Parameter	Symbol	Test Conditions	Min	Typ	Max	Unit
Feedback Voltage						
Feedback Reference Voltage	V _{REF}	(RT7238D)	0.594	0.6	0.606	V
Feedback Current	I _{FB}	V _{FB} = 4V (RT7238D)	-50	--	50	nA
On-Resistance						
Switch On-Resistance	High-Side	R _{DS(ON)_H}	--	27	--	mΩ
	Low-Side	R _{DS(ON)_L}	--	10	--	
Discharge FET R _{ON}	R _{Dis}		--	50	--	Ω
Current Limit						
Bottom FET Current limit	I _{LIM}	(RT7238B/C/E)	9	--	--	A
		I _{LMT} = "0"	8	--	--	A
		I _{LMT} = Floating	12	--	--	
		I _{LMT} = "1"	16	--	--	
ILMT Rising Threshold	V _{ILMTH}		V _{LDO} - 0.8	--	V _{LDO}	V
ILMT Falling Threshold	V _{ILMTL}		--	--	0.8	V
Oscillator Frequency						
Oscillator Frequency	f _{OSC}		0.45	0.5	0.55	MHz
On-Time Timer Control						
Minimum On-Time	T _{ON(MIN)}		--	50	--	ns
Minimum Off-Time	T _{OFF(MIN)}		--	200	--	ns
Soft-Start						
Soft-Start Time	T _{SS}	From EN/EN1 High to PGOOD High	--	1.5	--	ms
UVLO						
Input UVLO Threshold	V _{UVLO}	Wake up	--	--	3.9	V
UVLO Hysteresis	V _{HYS}		--	0.35	--	V
Output Over-Voltage Protection						
Output Over-Voltage Threshold		V _{FB} Rising	115	120	125	%
Output Over-Voltage Hysteresis			--	3	--	%
Output Over-Voltage Delay Time			--	20	--	μs
Output Under-Voltage Protection						
Output Under-Voltage Threshold		V _{FB} Falling	56	59	62	%
Output Under-Voltage Delay Time		FB Forced Below UV Threshold	--	2	--	μs
UV Blank Time		From EN/EN1 High	--	1.5	--	ms

Parameter	Symbol	Test Conditions	Min	Typ	Max	Unit
Power Good						
Power Good Threshold		V _{FB} Rising (Good)	88	91	94	%
Power Good Hysteresis			--	6	--	%
Power Good Delay Time		V _{FB} Rising (Good)	--	10	--	μs
LDO Regulator						
LDO Output Voltage	V _{LDO}	(RT7238B/D)	3.267	3.3	3.333	V
		(RT7238C/E)	4.95	5	5.05	
LDO Output Current Limit	I _{LMTLDO}		100	120	160	mA
Bypass Switch						
Bypass Switch RON	R _{byp}		--	3	5	Ω
Bypass Switch Turn-on Voltage	V _{byp_on}	(RT7238B/D)	--	3.1	--	V
		(RT7238C)	--	4.8	--	
		(RT7238E)	--	4.7	--	
Bypass Switch Switchover Hysteresis		(RT7238B/D)	--	0.2	--	V
		(RT7238C/E)	--	0.1	--	
Thermal Shutdown						
Thermal Shutdown Threshold	T _{SD}		--	150	--	°C
Thermal Shutdown Hysteresis	ΔT _{SD}		--	25	--	°C

Note 1. Stresses beyond those listed “Absolute Maximum Ratings” may cause permanent damage to the device. These are stress ratings only, and functional operation of the device at these or any other conditions beyond those indicated in the operational sections of the specifications is not implied. Exposure to absolute maximum rating conditions may affect device reliability.

Note 2. θ_{JA} is measured at T_A = 25°C on a high effective thermal conductivity four-layer test board per JEDEC 51-7.

Note 3. Devices are ESD sensitive. Handling precautions are recommended.

Note 4. The device is not guaranteed to function outside its operating conditions.

Typical Application Circuit

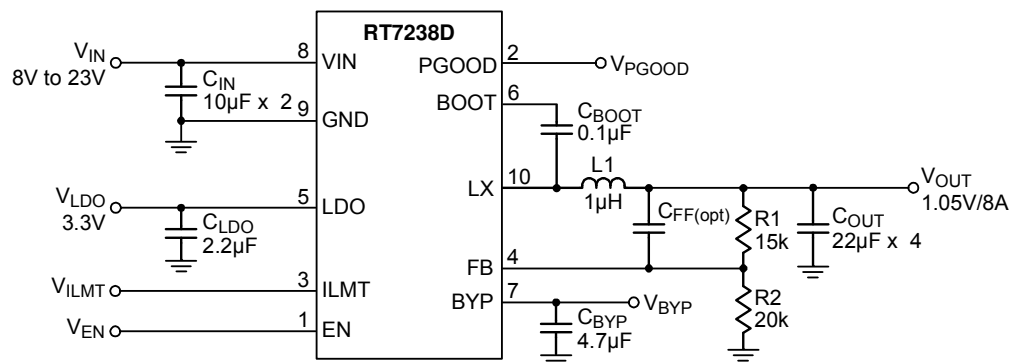
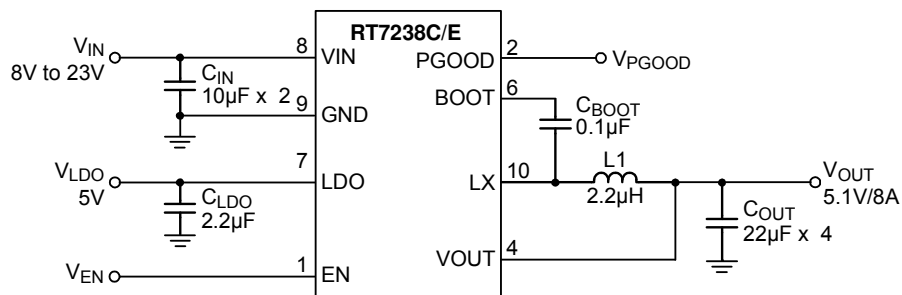
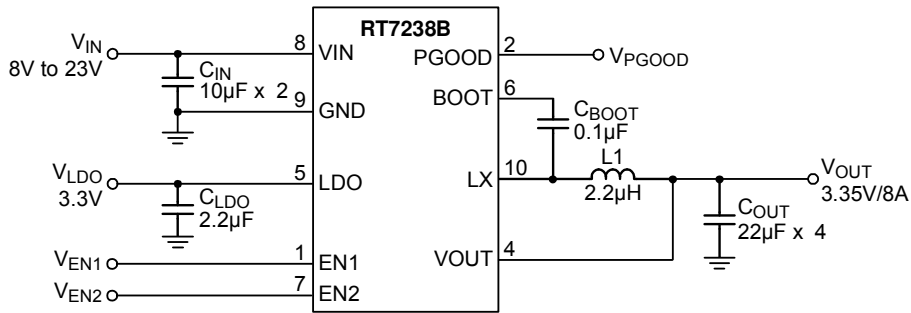

Typical Operating Characteristics

Efficiency vs. Output Current

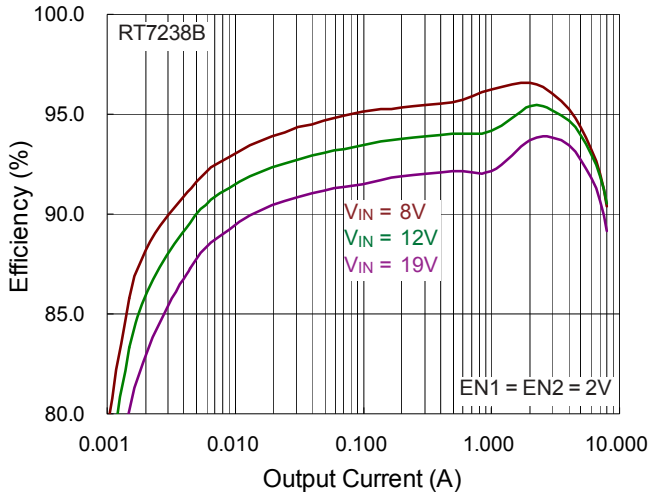

Efficiency vs. Output Current

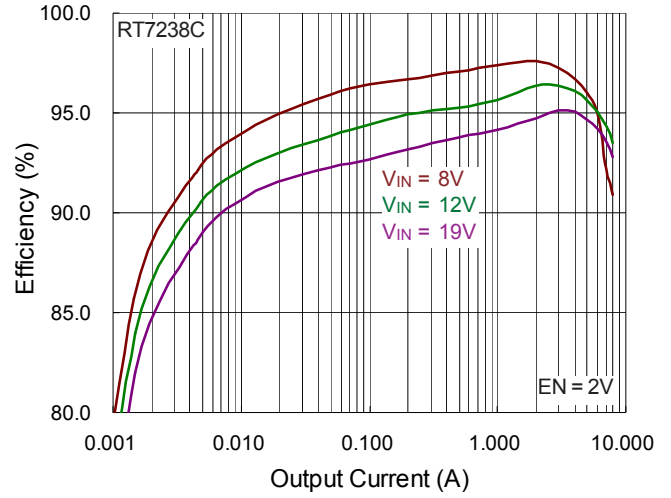

Efficiency vs. Output Current

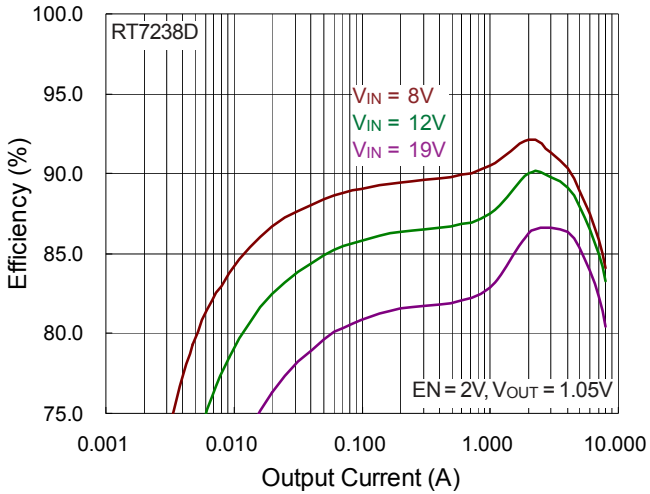

Switching Frequency vs. Output Current

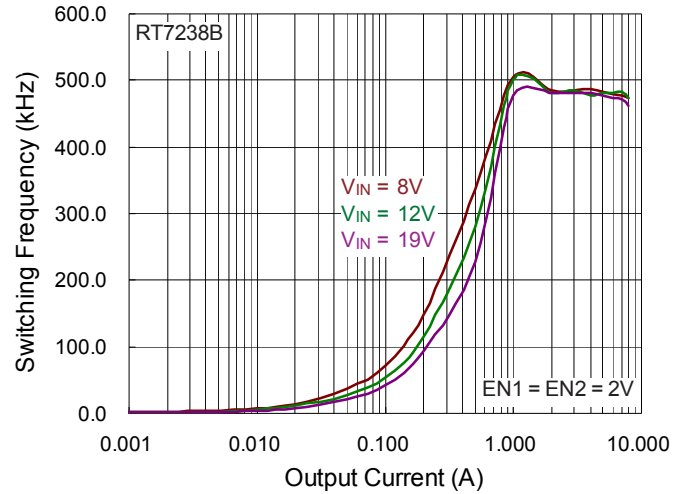

Switching Frequency vs. Output Current

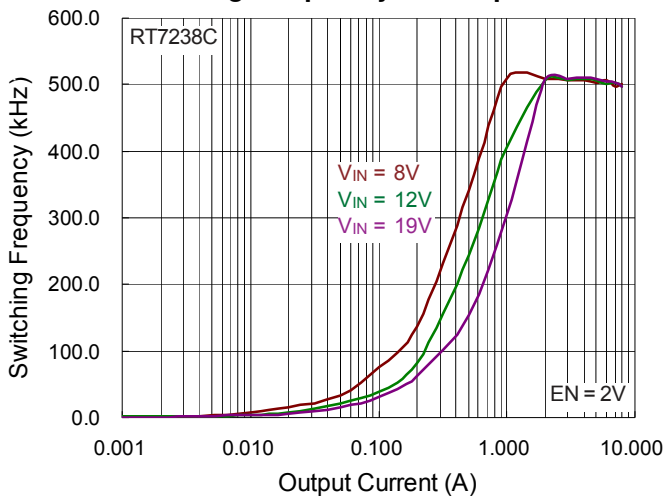

Switching Frequency vs. Output Current

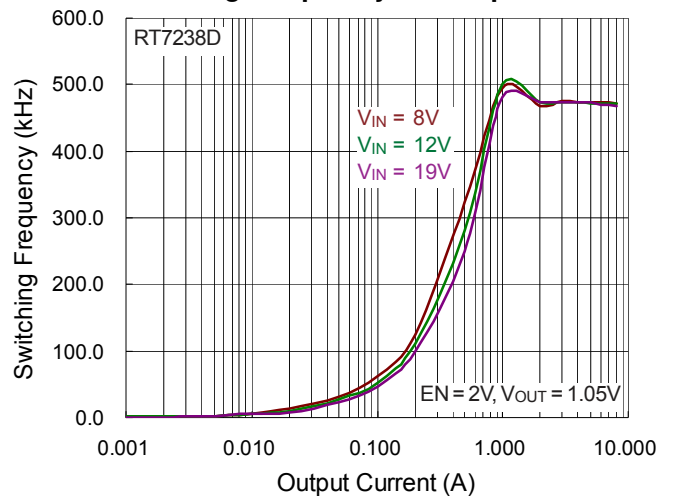

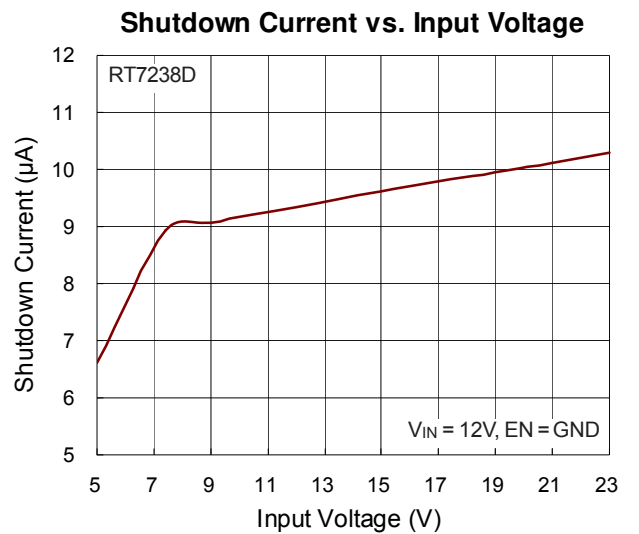
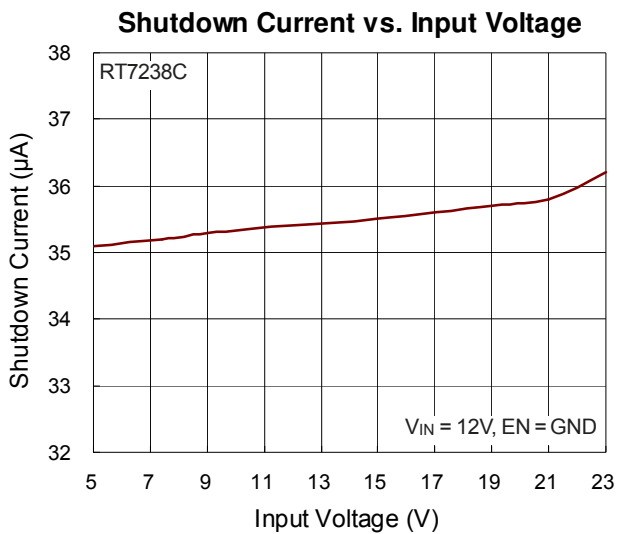
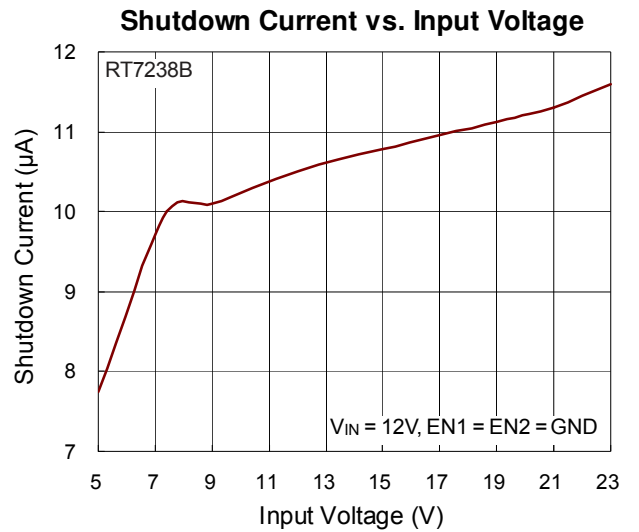
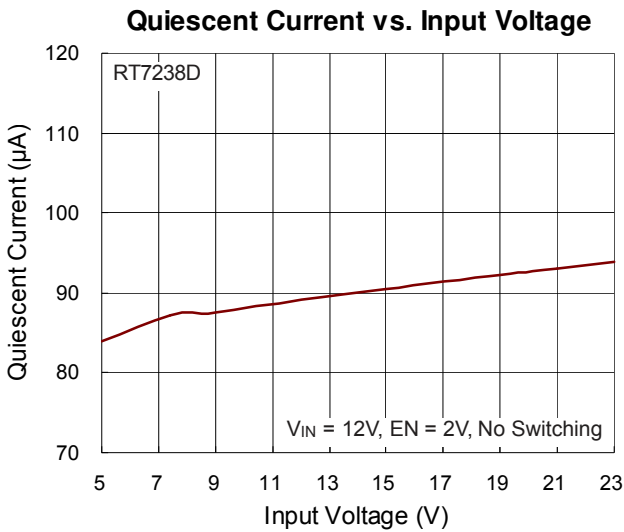
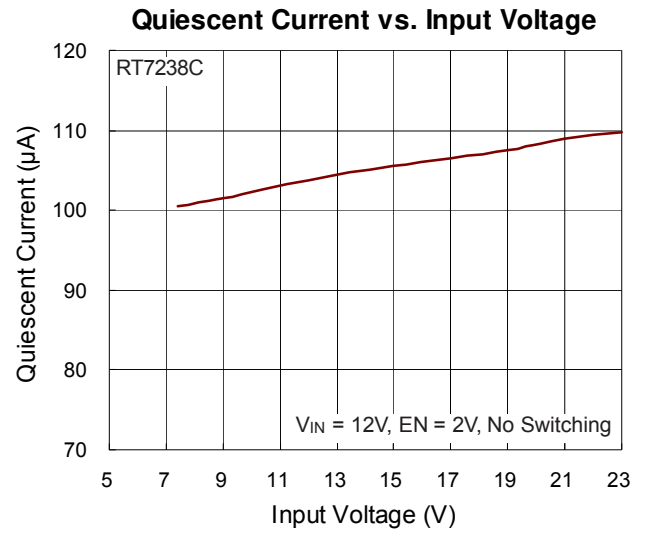
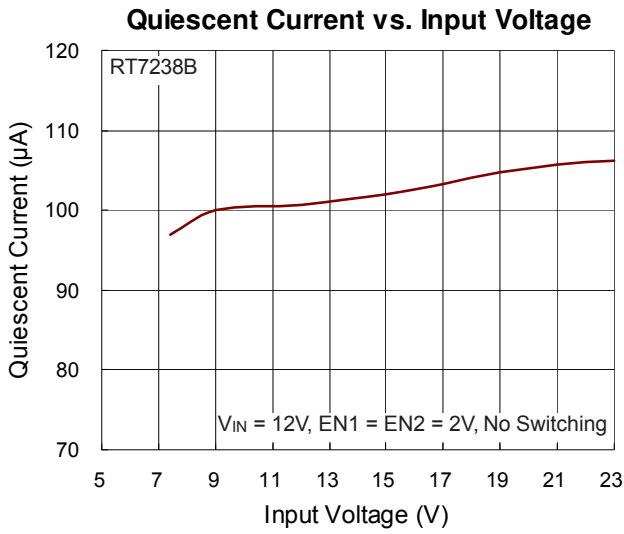

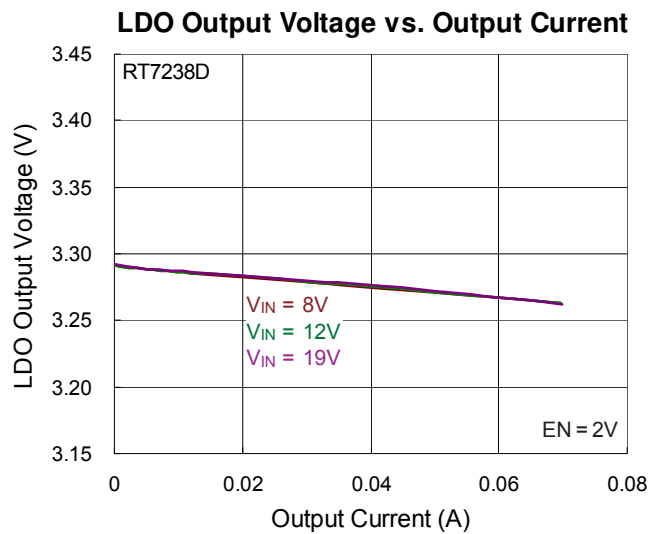
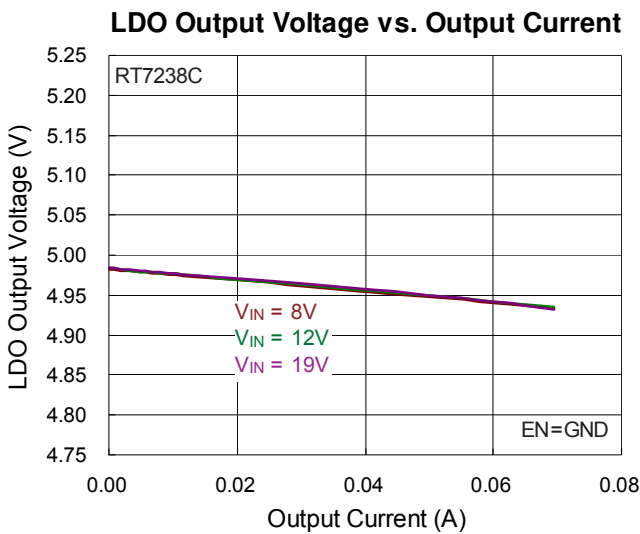
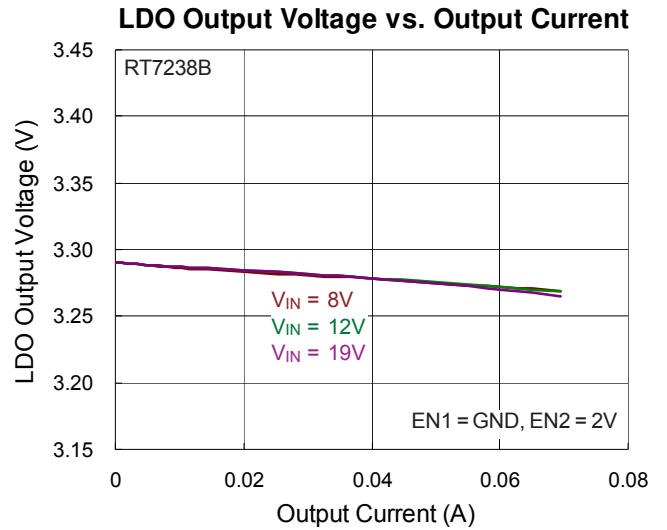
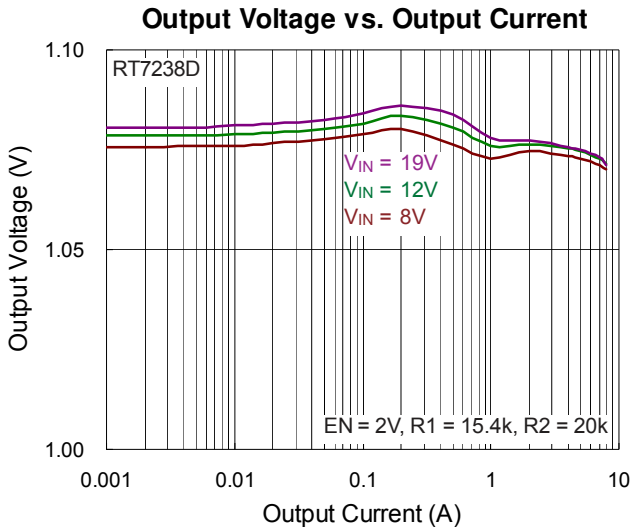
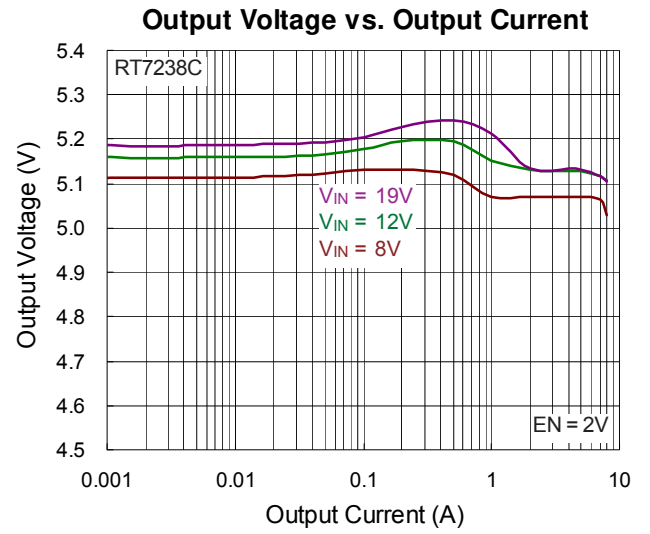
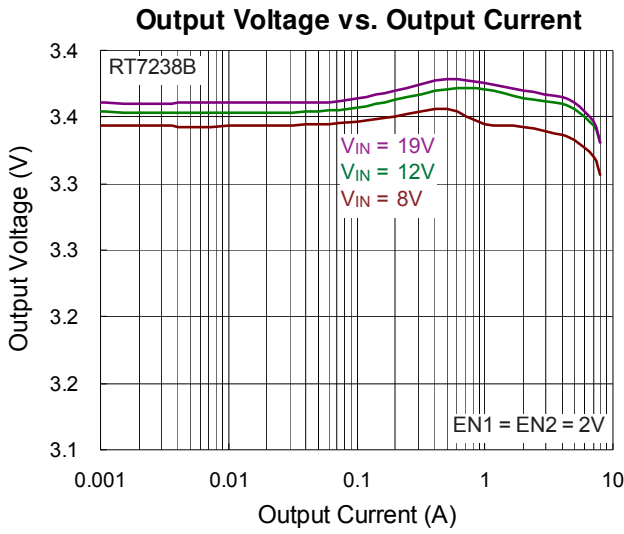

Start-Up through EN1

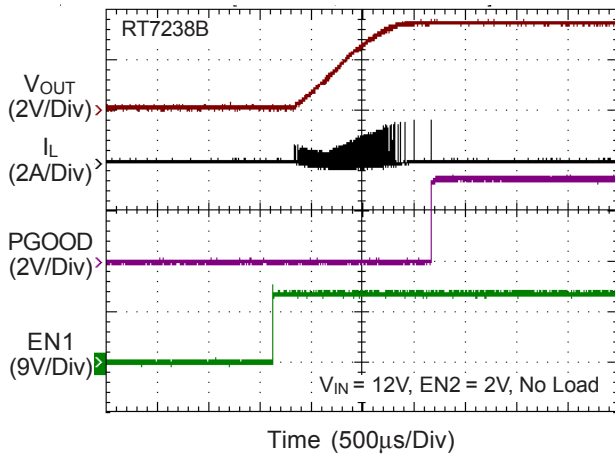

Start-Up through EN2

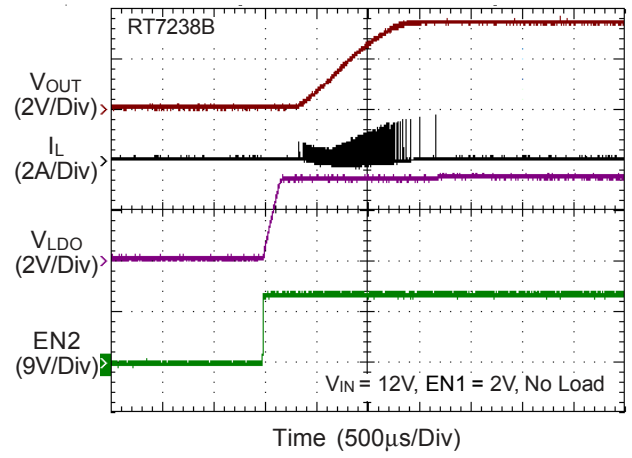

Start-Up through EN

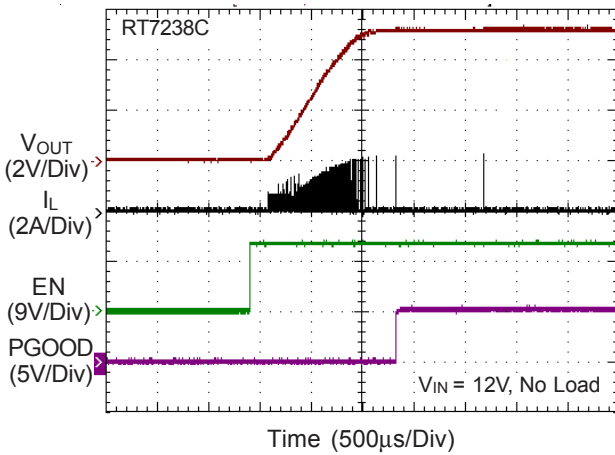

Start-Up through EN

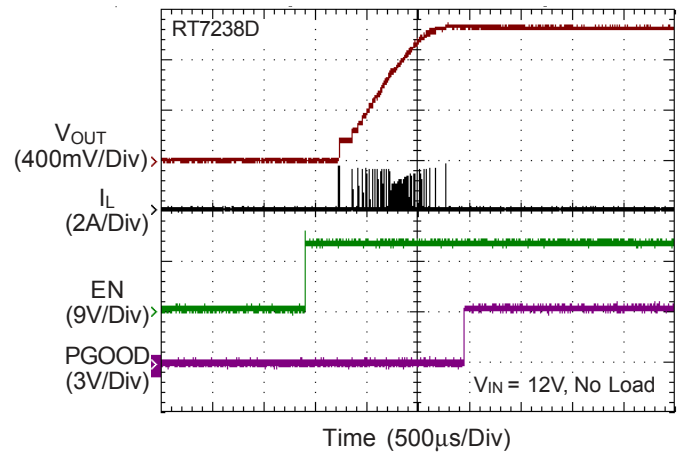

Power-Off through EN1

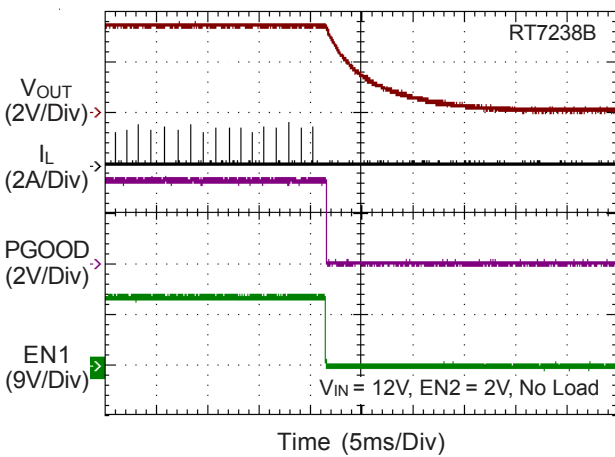

Power-Off through EN2

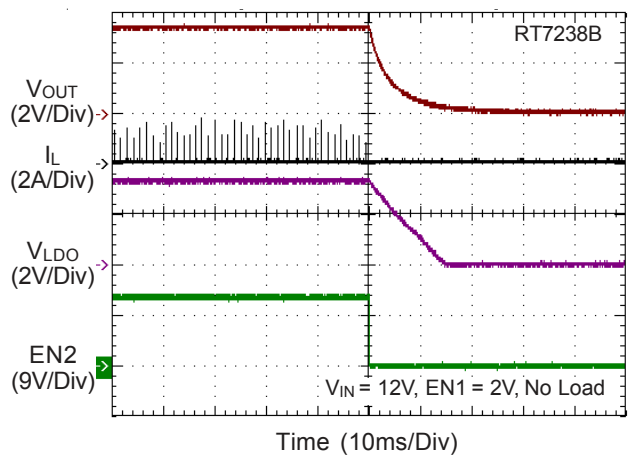

Power-Off through EN

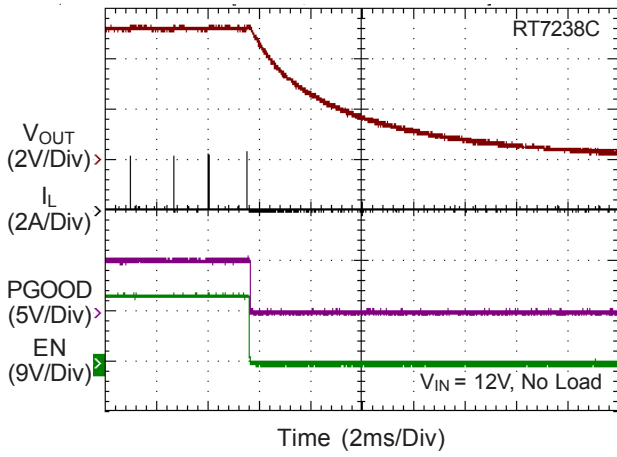

Power-Off through EN

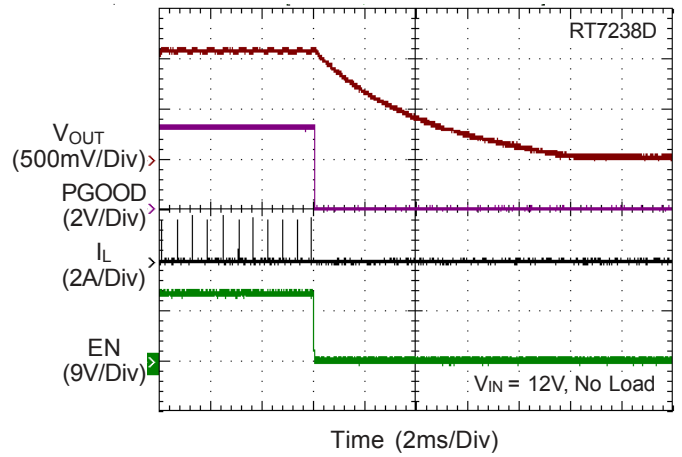

Load Transient Response

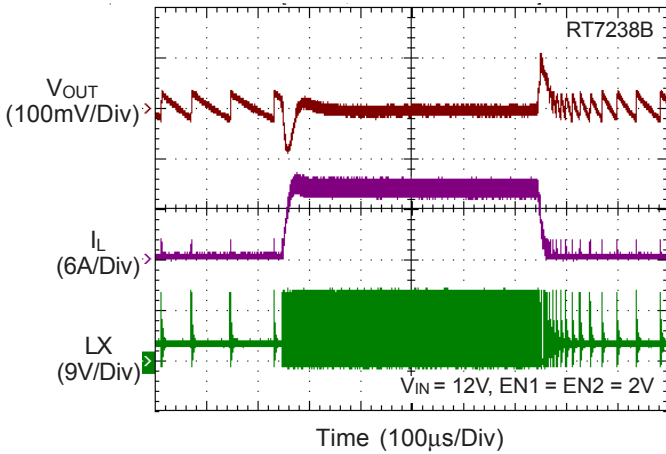

Load Transient Response

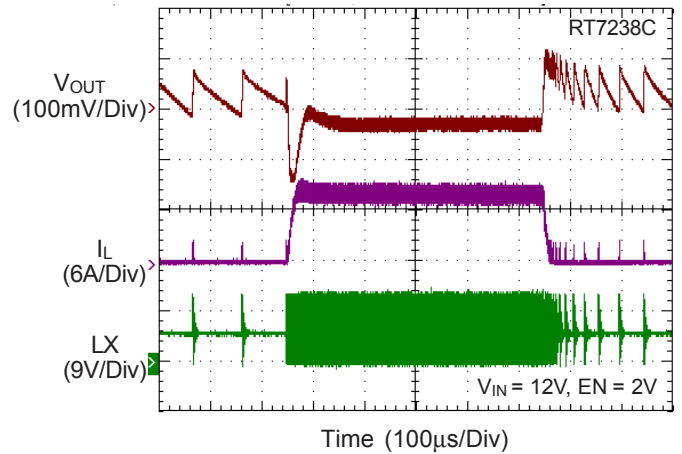

Load Transient Response

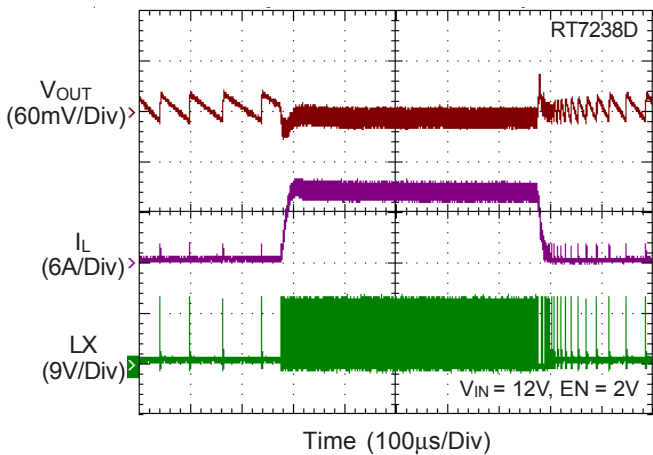

Over Voltage Protection

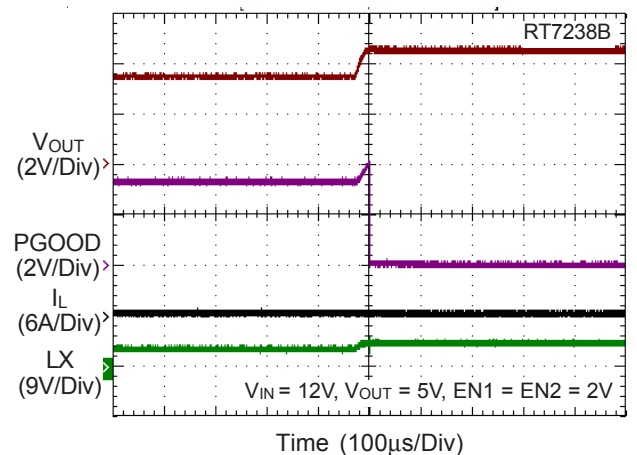

Over Voltage Protection

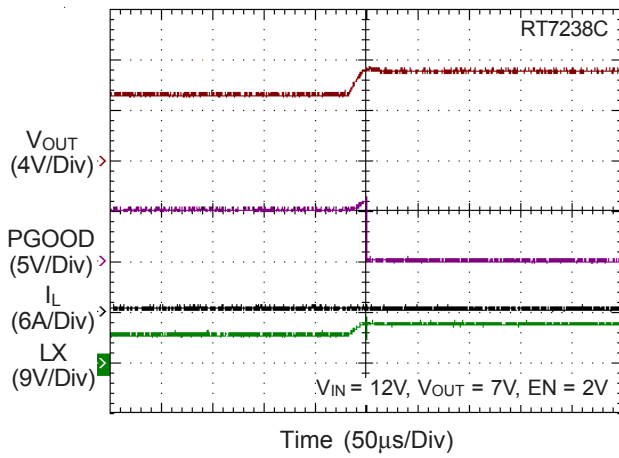

Over Voltage Protection

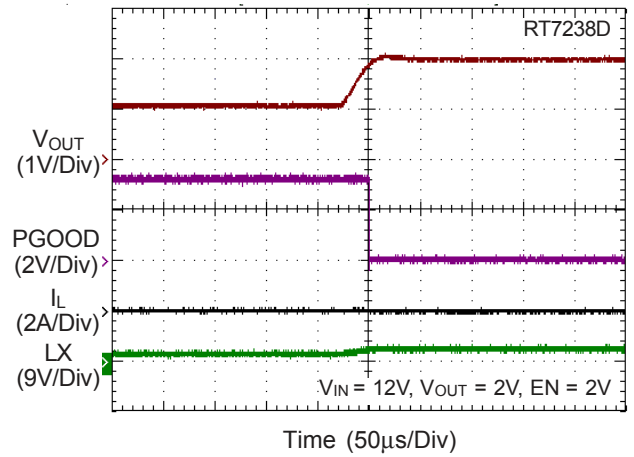

Under Voltage Protection

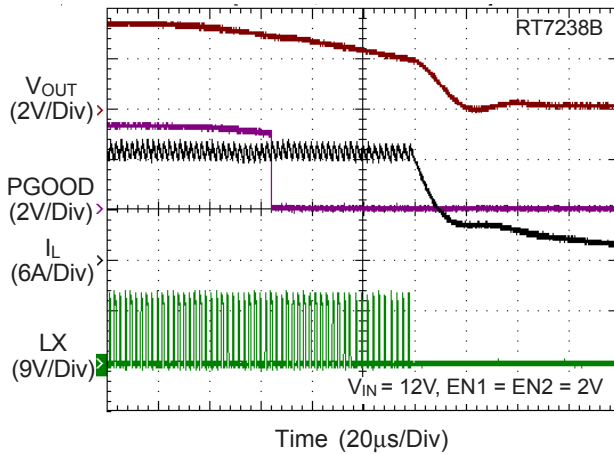

Under Voltage Protection

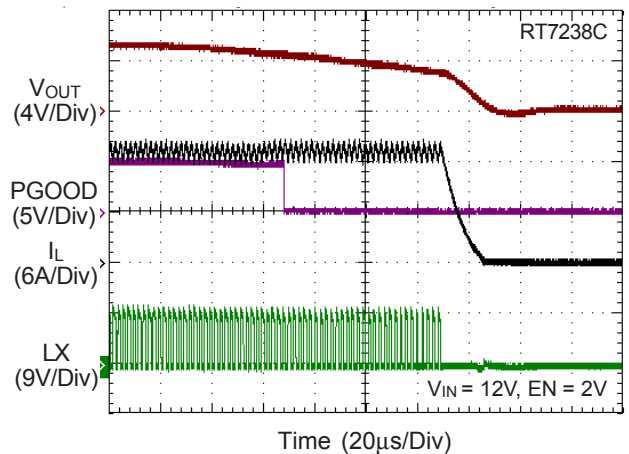

Under Voltage Protection

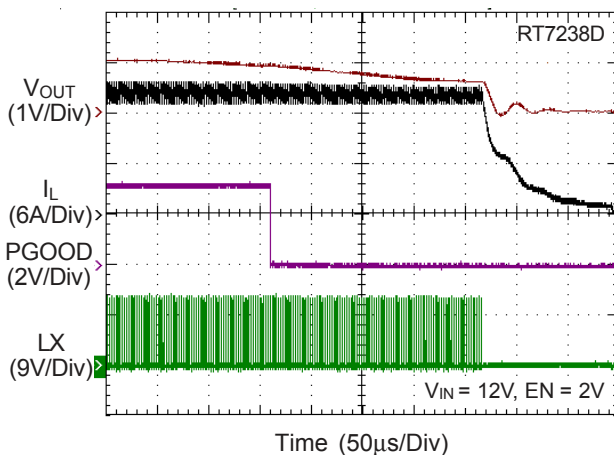

Application Information

The RT7238B/C/D/E are high-performance 500kHz 8A step-down regulators with internal power switches and synchronous rectifiers. They feature an Advanced Constant On-Time (ACOT™) control architecture that provides stable operation for ceramic output capacitors without complicated external compensation, among other benefits. The input voltage range are from 8V to 23V (RT7238B/C/D/E). The output voltage are fixed 3.35V (RT7238B), 5.1V (RT7238C), 5V (RT7238E) or adjustable from 0.6V to 5V (RT7238D).

The proprietary ACOT™ control scheme improves conventional constant on-time architectures, achieving nearly constant switching frequency over line, load, and output voltage ranges. Since there is no internal clock, response to transients is nearly instantaneous and inductor current can ramp quickly to maintain output regulation without large bulk output capacitance.

The RT7238B/C/D/E includes 5V (RT7238C) and 3.3V (RT7238B/D) linear regulators (LDO). The linear regulator steps down input voltage to supply both internal circuitry and gate drivers. The synchronous switch gate drivers are directly powered by LDO. When VOUT rises above 3.1V (RT7238B/D), 4.8V (RT7238C), 4.7V (RT7238E) an automatic circuit disconnects the linear regulator and allows the device to be powered by VOUT (RT7238B/C/E) or via the BYP pin (RT7238D).

ACOT™ Control Architecture

Making the on-time proportional to VOUT and inversely proportional to VIN is not sufficient to achieve good constant-frequency behavior for several reasons. First, voltage drops across the MOSFET switches and inductor cause the effective input voltage to be less than the measured input voltage and the effective output voltage to be greater than the measured output voltage as sensing input and output voltage from LX pin. When the load change, the switch voltage drops change causing a switching frequency variation with load current. Also, at light loads if the inductor current goes negative, the switch dead-time between the synchronous rectifier turn-off and the high-side switch turn-on allows the switching node to rise to the input voltage. This increases the effective on-

time and causes the switching frequency to drop noticeably.

One way to reduce these effects is to measure the actual switching frequency and compare it to the desired range. This has the added benefit eliminating the need to sense the actual output voltage, potentially saving one pin connection. ACOT™ uses this method, measuring the actual switching frequency and modifying the on-time with a feedback loop to keep the average switching frequency in the desired range.

In order to achieve good stability with low-ESR ceramic capacitors, ACOT™ uses a virtual inductor current ramp generated inside the IC. This internal ramp signal replaces the ESR ramp normally provided by the output capacitor's ESR. The ramp signal and other internal compensations are optimized for low-ESR ceramic output capacitors.

ACOT™ One-shot Operation

The RT7238B/C/D/E control algorithm is simple to understand. The feedback voltage, with the virtual inductor current ramp added, is compared to the reference voltage. When the combined signal is less than the reference, the on-time one-shot is triggered, as long as the minimum off-time one-shot is clear and the measured inductor current (through the synchronous rectifier) is below the current limit. The on-time one-shot turns on the high-side switch and the inductor current ramps up linearly. After the on-time,

the high-side switch is turned off and the synchronous rectifier is turned on and the inductor current ramps down linearly. At the same time, the minimum off-time one-shot is triggered to prevent another immediate on-time during the noisy switching time and allow the feedback voltage and current sense signals to settle. The minimum off-time is kept short (200ns typical) so that rapidly-repeated on-times can raise the inductor current quickly when needed.

Bypass Function

The RT7238B/C/D/E provide bypass function to improve power conversion efficiency. When the bypass pin voltage (RT7238D) or output voltage (RT7238B/C/E) rises

above bypass switch turn-on threshold, the LDO regulator will shut down and the LDO pin will be connected to the bypass pin (RT7238D) or output pin (RT7238B/C/E) through an internal switch. Because the internal switch has turn-on resistor, there will be a naturally voltage drop of LDO pin as bypass function working. In practical application, the voltage drop of LDO pin should be considered.

Diode Emulation Mode

In diode emulation mode, the RT7238B/C/D/E automatically reduces switching frequency at light load conditions to maintain high efficiency. This reduction of frequency is achieved smoothly. As the output current decreases from heavy load condition, the inductor current is also reduced, and eventually comes to the point that its current valley touches zero, which is the boundary between continuous conduction and discontinuous conduction modes. To emulate the behavior of diodes, the low-side MOSFET allows only partial negative current to flow when the inductor free wheeling current becomes negative. As the load current is further decreased, it takes longer and longer time to discharge the output capacitor to the level that requires the next “ON” cycle. In reverse, when the output current increases from light load to heavy load, the switching frequency increases to the preset value as the inductor current reaches the continuous conduction. The transition load point to the light load operation is shown in Figure 1. and can be calculated as follows :

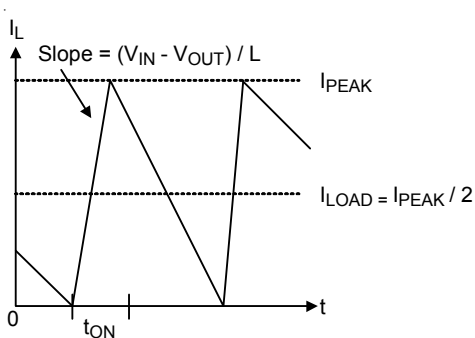

Figure 1. Boundary Condition of CCM/DEM

$$I_{LOAD(SKIP)} \approx \frac{(V_{IN} - V_{OUT})}{2L} \times t_{ON}$$

where t_{ON} is the on-time.

The switching waveforms may appear noisy and asynchronous when light load causes diode emulation operation. This is normal and results in high efficiency.

Trade offs in DEM noise vs. light load efficiency is made by varying the inductor value. Generally, low inductor values produce a broader efficiency vs. load curve, while higher values result in higher full load efficiency (assuming that the coil resistance remains fixed) and less output voltage ripple. Penalties for using higher inductor values include larger physical size and degraded load transient response (especially at low input voltage levels).

During discontinuous switching, the on-time is immediately increased to add “hysteresis” to discourage the IC from switching back to continuous switching unless the load increases substantially. The IC returns to continuous switching as soon as an on-time is generated before the inductor current reaches zero. The on-time is reduced back to the length needed for 500kHz switching and encouraging the circuit to remain in continuous conduction, preventing repetitive mode transitions between continuous switching and discontinuous switching.

Linear Regulators (LDO)

The RT7238B/C/D/E includes 5V (RT7238C/E) and 3.3V (RT7238B/D) linear regulators (LDO). The regulators can supply up to 70mA for external loads. When V_{OUT} is higher than the switch over threshold 3.1V (RT7238B/D), 4.8V (RT7238C), 4.7V (RT7238E) an internal 3Ω P-MOSFET switch connects V_{OUT} (RT7238B/C/E) or BYP (RT7238D) to the LDO pin while simultaneously disconnects the internal linear regulator.

Current Limit

The RT7238B/C/D/E current limit is fixed 9A (RT7238B/C/E) or adjustable (8A, 12A, 16A) by ILMT pin (RT7238D) and it is a cycle-by-cycle “valley” type, measuring the inductor current through the synchronous rectifier during the off-time while the inductor current ramps down. The current is determined by measuring the voltage between source and drain of the synchronous rectifier, adding temperature compensation for greater accuracy. If the current exceeds the current limit, the on-time one-shot is inhibited until the inductor current ramps down below the current limit. Thus, only when the inductor current is well below the current limit, another on-time is permitted. If the output current exceeds the available inductor current

(controlled by the current limit mechanism), the output voltage will drop. If it drops below the output under-voltage protection level (see next section) the IC will stop switching to avoid excessive heat.

The RT7238B/C/D/E also includes a negative current limit to protect the IC against sinking excessive current and possibly damaging the IC. If the voltage across the synchronous rectifier indicates the negative current is too high, the synchronous rectifier turns off until after the next high-side on-time.

Output Over-voltage Protection and Under-voltage Protection

The RT7238B/C/D/E include output over-voltage protection (OVP). If the output voltage rises above the regulation level, the high-side and low-side switch naturally remain off. If the output voltage exceeds the OVP trip threshold for longer than 20 μ s (typical), the IC's OVP is triggered. The RT7238B/C/D/E also include output Under-Voltage Protection (UVP). If the output voltage drops below the UVP trip threshold for longer than 2 μ s (typical) the IC's UVP is triggered. The RT7238B/C/D/E use latch-off mode OVP and UVP. When the protection function is triggered, the IC will shut down. The IC stops switching and is latched off. To restart operation, toggle EN or power the IC off and then on again.

Input Under-Voltage Lockout

In addition to the enable function, the RT7238B/C/D/E feature an Under-Voltage Lockout (UVLO) function that monitors the input voltage. To prevent operation without fully-enhanced internal MOSFET switches, this function inhibits switching when input voltage drops below the UVLO-falling threshold. The IC resumes switching when input voltage exceeds the UVLO-rising threshold.

Over-Temperature Protection

The RT7238B/C/D/E includes an Over-Temperature Protection (OTP) circuitry to prevent overheating due to excessive power dissipation. The OTP will shut down switching operation when the junction temperature exceeds 150°C. Once the junction temperature cools down by approximately 25°C the IC will resume normal

operation with a complete soft-start. For continuous operation, provide adequate cooling so that the junction temperature does not exceed 150°C.

Enable and Disable

The enable input (EN) has a logic-low level of 0.3V. When V_{EN} is below this level the IC enters shutdown mode and supply current drops to less than 5 μ A.(typical) When V_{EN} exceeds its logic-high level of 0.8V the IC is fully operational.

Soft-Start

The RT7238B/C/D/E provides an internal soft-start function to prevent large inrush current and output voltage overshoot when the converter starts up. The soft-start (SS) automatically begins once the chip is enabled. During soft-start, it clamps the ramping of internal reference voltage which is compared with FB signal. The typical soft-start duration is 0.8ms. A unique PWM duty limit control that prevents output over-voltage during soft-start period is designed specifically for FB floating.

Power Off

When EN is low or any protection function is triggered, an internal discharging resistor about 50 Ω will discharging the residual charges of output capacitors to make sure next soft start without any remaining charge.

Power Good Output (PGOOD)

The power good output is an open drain output that requires a pull-up resistor. When the output voltage is 15% (typical) below its set voltage, PGOOD will be pulled low. It is held low until the output voltage returns to 91% of its set voltage once more. During soft-start, PGOOD is actively held low and only allowed to be pulled high after soft-start is over and the output reaches 91% of its set voltage. There is a 2 μ s delay built into PGOOD circuitry to prevent false transition.

External Bootstrap Capacitor (C_{BOOT})

Connect a 0.1 μ F low ESR ceramic capacitor between BOOT pin and LX pin. This bootstrap capacitor provides the gate driver supply voltage for the high-side N-MOSFET switch.

The internal power MOSFET switch gate driver is optimized to turn the switch on fast enough for low power loss and good efficiency, but also slow enough to reduce EMI. Switch turn-on is when most EMI occurs since V_{LX} rises rapidly. During switch turn-off, LX is discharged relatively slowly by the inductor current during the dead-time between high-side and low-side switch on-times. In some cases it is desirable to reduce EMI further, at the expense of some additional power dissipation. The switch turn-on can be slowed by placing a small ($<10\Omega$) resistance between BOOT and the external bootstrap capacitor. This will slow the high-side switch turn-on and V_{LX} 's rise.

Output Voltage Setting (RT7238D)

Set the desired output voltage using a resistive divider from the output to ground with the midpoint connected to FB. The output voltage is set according to the following equation :

$$V_{OUT(\text{valley})} = 0.6V \times \left(1 + \frac{R1}{R2}\right)$$

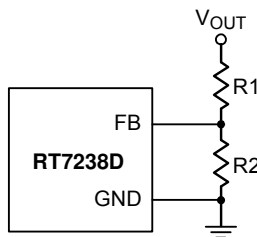

Figure 2. Output Voltage Setting

Place the FB resistors within 5mm of the FB pin. Choose R2 between $10k\Omega$ and $100k\Omega$ to minimize power consumption without excessive noise pick-up and calculate R1 as follows :

$$R1 = \frac{R2 \times (V_{OUT(\text{valley})} - 0.6V)}{0.6V}$$

For output voltage accuracy, use divider resistors with 1% or better tolerance.

Inductor Selection

Selecting an inductor involves specifying its inductance and also its required peak current. The exact inductor value is generally flexible and is ultimately chosen to obtain the best mix of cost, physical size, and circuit efficiency. Lower inductor values benefit from reduced size and cost

and they can improve the circuit's transient response, but they increase the inductor ripple current and output voltage ripple and reduce the efficiency due to the resulting higher peak currents. Conversely, higher inductor values increase efficiency, but the inductor will either be physically larger or have higher resistance since more turns of wire are required and transient response will be slower since more time is required to change current (up or down) in the inductor. A good compromise between size, efficiency, and transient response is to use a ripple current (ΔI_L) about 20-50% of the desired full output load current. Calculate the approximate inductor value by selecting the input and output voltages, the switching frequency (f_{SW}), the maximum output current ($I_{OUT(MAX)}$) and estimating a ΔI_L as some percentage of that current.

$$L = \frac{V_{OUT} \times (V_{IN} - V_{OUT})}{V_{IN} \times f_{SW} \times \Delta I_L}$$

Once an inductor value is chosen, the ripple current (ΔI_L) is calculated to determine the required peak inductor current.

$$\Delta I_L = \frac{V_{OUT} \times (V_{IN} - V_{OUT})}{V_{IN} \times f_{SW} \times L} \quad \text{and}$$

$$I_{L(PEAK)} = I_{OUT(MAX)} + \frac{\Delta I_L}{2}$$

To guarantee the required output current, the inductor needs a saturation current rating and a thermal rating that exceeds $I_{L(PEAK)}$. These are minimum requirements. To maintain control of inductor current in overload and short-circuit conditions, some applications may desire current ratings up to the current limit value. However, the IC's output under-voltage shutdown feature make this unnecessary for most applications.

For best efficiency, choose an inductor with a low DC resistance that meets the cost and size requirements. For low inductor core losses some type of ferrite core is usually best and a shielded core type, although possibly larger or more expensive, will probably give fewer EMI and other noise problems.

Input Capacitor Selection

High quality ceramic input decoupling capacitor, such as X5R or X7R, with values greater than $20\mu F$ are recommended for the input capacitor. The X5R and X7R ceramic capacitors are usually selected for power regulator

capacitors because the dielectric material has less capacitance variation and more temperature stability. Voltage rating and current rating are the key parameters when selecting an input capacitor. Generally, selecting an input capacitor with voltage rating 1.5 times greater than the maximum input voltage is a conservatively safe design. The input capacitor is used to supply the input RMS current, which can be approximately calculated using the following equation :

$$I_{RMS} = \sqrt{\frac{V_{OUT}}{V_{IN}} \times \left[\left(1 - \frac{V_{OUT}}{V_{IN}}\right) \times I_{OUT}^2 + \frac{\Delta I_L^2}{12} \right]}$$

The next step is to select a proper capacitor for RMS current rating. One good design uses more than one capacitor with low Equivalent Series Resistance (ESR) in parallel to form a capacitor bank. The input capacitance value determines the input ripple voltage of the regulator. The input voltage ripple can be approximately calculated using the following equation :

$$\Delta V_{IN} = \frac{I_{OUT} \times V_{IN}}{C_{IN} \times f_{SW} \times V_{OUT}} \times \left(1 - \frac{V_{OUT}}{V_{IN}}\right)$$

The typical operating circuit is recommended to use two 10µF and low ESR ceramic capacitors on the input.

Output Capacitor Selection

The RT7238B/C/D/E are optimized for ceramic output capacitors and best performance will be obtained using them. The total output capacitance value is usually determined by the desired output voltage ripple level and transient response requirements for sag (undershoot on positive load steps) and soar (overshoot on negative load steps).

Output ripple at the switching frequency is caused by the inductor current ripple and its effect on the output capacitor's ESR and stored charge. These two ripple components are called ESR ripple and capacitive ripple. Since ceramic capacitors have extremely low ESR and relatively little capacitance, both components are similar in amplitude and both should be considered if ripple is critical.

$$V_{RIPPLE} = V_{RIPPLE(ESR)} + V_{RIPPLE(C)}$$

$$V_{RIPPLE(ESR)} = \Delta I_L \times RESR$$

$$V_{RIPPLE(C)} = \frac{\Delta I_L}{8 \times C_{OUT} \times f_{SW}}$$

In addition to voltage ripple at the switching frequency, the output capacitor and its ESR also affect the voltage sag (undershoot) and soar (overshoot) when the load steps up and down abruptly. The ACOT transient response is very quick and output transients are usually small. However, the combination of small ceramic output capacitors (with little capacitance), low output voltages (with little stored charge in the output capacitors), and low duty cycle applications (which require high inductance to get reasonable ripple currents with high input voltages) increases the size of voltage variations in response to very quick load changes. Typically, load changes occur slowly with respect to the IC's 500kHz switching frequency. But some modern digital loads can exhibit nearly instantaneous load changes and the following section shows how to calculate the worst-case voltage swings in response to very fast load steps.

The amplitude of the ESR step up or down is a function of the load step and the ESR of the output capacitor :

$$V_{ESR_STEP} = \Delta I_{OUT} \times RESR$$

The amplitude of the capacitive sag is a function of the load step, the output capacitor value, the inductor value, the input-to-output voltage differential, and the maximum duty cycle. The maximum duty cycle during a fast transient is a function of the on-time and the minimum off-time since the ACOT™ control scheme will ramp the current using on-times spaced apart with minimum off-times, which is as fast as allowed. Calculate the approximate on-time (neglecting parasitics) and maximum duty cycle for a given input and output voltage as :

$$t_{ON} = \frac{V_{OUT}}{V_{IN} \times f_{SW}} \text{ and } D_{MAX} = \frac{t_{ON}}{t_{ON} + t_{OFF(MIN)}}$$

The actual on-time will be slightly longer as the IC compensates for voltage drops in the circuit, but we can neglect both of these since the on-time increase compensates for the voltage losses. Calculate the output voltage sag as :

$$V_{SAG} = \frac{L \times (\Delta I_{OUT})^2}{2 \times C_{OUT} \times (V_{IN(MIN)} \times D_{MAX} - V_{OUT})}$$

The amplitude of the capacitive soar is a function of the load step, the output capacitor value, the inductor value and the output voltage :

$$V_{SOAR} = \frac{L \times (\Delta I_{OUT})^2}{2 \times C_{OUT} \times V_{OUT}}$$

Most applications never experience instantaneous full load steps and the RT7238B/C/D/E's high switching frequency and fast transient response can easily control voltage regulation at all times. Therefore, sag and soar are seldom an issue except in very low-voltage CPU core or DDR memory supply applications, particularly for devices with high clock frequencies and quick changes into and out of sleep modes. In such applications, simply increasing the amount of ceramic output capacitor (sag and soar are directly proportional to capacitance) or adding extra bulk capacitance can easily eliminate any excessive voltage transients.

In any application with large quick transients, it should calculate soar and sag to make sure that over-voltage protection and under-voltage protection will not be triggered.

Thermal Considerations

For continuous operation, do not exceed absolute maximum junction temperature. The maximum power dissipation depends on the thermal resistance of the IC package, PCB layout, rate of surrounding airflow, and difference between junction and ambient temperature. The maximum power dissipation can be calculated by the following formula :

$$P_{D(MAX)} = (T_{J(MAX)} - T_A) / \theta_{JA}$$

where $T_{J(MAX)}$ is the maximum junction temperature, T_A is the ambient temperature, and θ_{JA} is the junction to ambient thermal resistance.

For recommended operating condition specifications, the maximum junction temperature is 125°C. The junction to ambient thermal resistance, θ_{JA} , is layout dependent. For UQFN-10L 3x3 (FC) package, the thermal resistance, θ_{JA} , is 30°C/W on a standard JEDEC 51-7 four-layer thermal test board. The maximum power dissipation at $T_A = 25^\circ\text{C}$ can be calculated by the following formula :

$$P_{D(MAX)} = (125^\circ\text{C} - 25^\circ\text{C}) / (30^\circ\text{C/W}) = 3.3\text{W for UQFN-10L 3x3 (FC) package}$$

The maximum power dissipation depends on the operating ambient temperature for fixed $T_{J(MAX)}$ and thermal resistance, θ_{JA} . The derating curve in Figure 3 allows the designer to see the effect of rising ambient temperature on the maximum power dissipation.

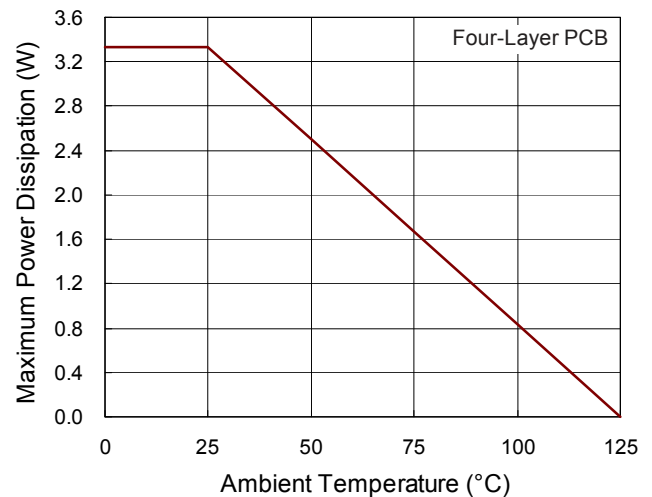
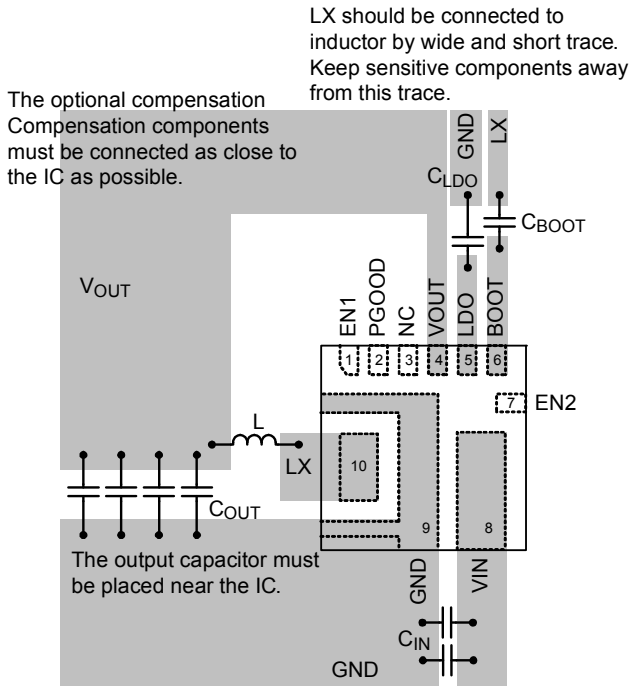

Figure 3. Derating Curve of Maximum Power Dissipation

Layout Considerations

Layout is very important in high frequency switching converter design. The PCB can radiate excessive noise and contribute to converter instability with improper layout. Certain points must be considered before starting a layout using the RT7238B/C/D/E.

- ▶ Make the traces of the main current paths as short and wide as possible.
- ▶ Put the input capacitor as close as possible to the device pins (V_{IN} and GND).
- ▶ LX node encounters high frequency voltage swings so it should be kept in a small area. Keep sensitive components away from the LX node to prevent stray as possible.
- ▶ The GND pin should be connected to a strong ground plane for heat sinking and noise protection.
- ▶ Avoid using vias in the power path connections that have switched currents (from C_{IN} to GND and C_{IN} to V_{IN}) and the switching node (LX).
- ▶ An example of PCB layout guide is shown in Figure 4 for reference.



(RT7238B)

(a) For UQFN-10L 3x3 (FC) Package

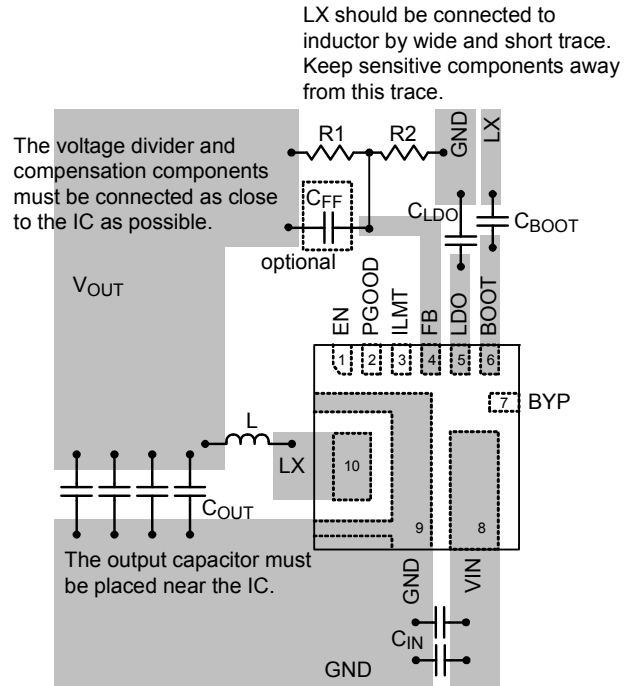

(RT7238D)

(c) For UQFN-10L 3x3 (FC) Package

Figure 4. PCB Layout Guide

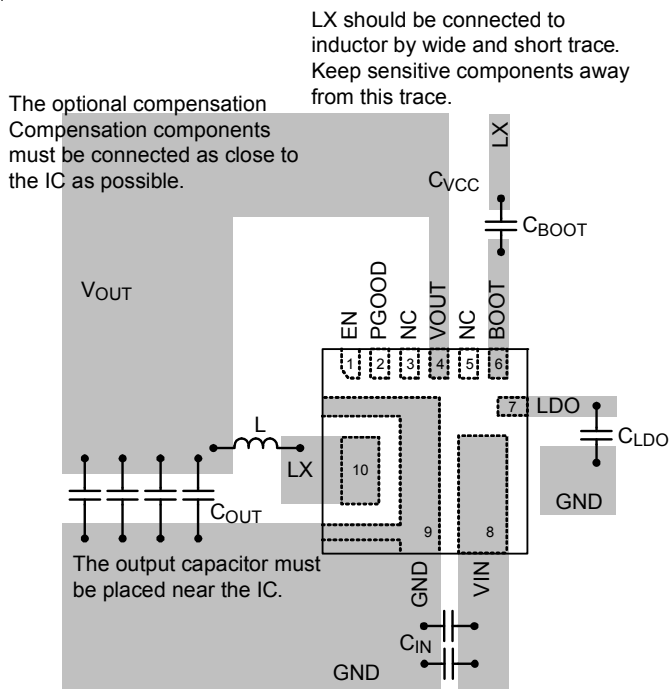

(RT7238C/E)

(b) For UQFN-10L 3x3 (FC) Package

Outline Dimension

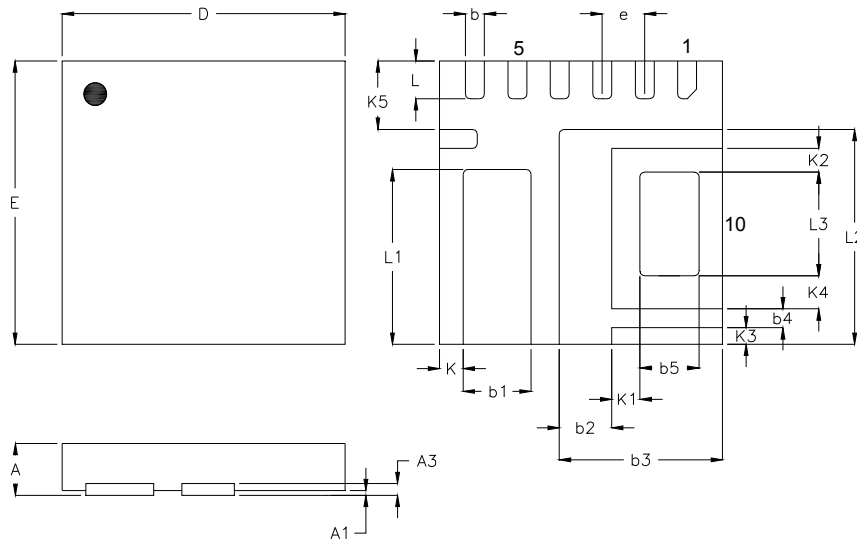

Symbol	Dimensions In Millimeters		Dimensions In Inches	
	Min.	Max.	Min.	Max.
A	0.500	0.600	0.020	0.024
A1	0.000	0.050	0.000	0.002
A3	0.100	0.175	0.004	0.007
b	0.150	0.250	0.006	0.010
b1	0.670	0.770	0.026	0.030
b2	0.505	0.605	0.020	0.024
b3	1.680	1.780	0.066	0.070
b4	0.150	0.250	0.006	0.010
b5	0.575	0.675	0.023	0.027
D	2.950	3.050	0.116	0.120
E	2.950	3.050	0.116	0.120
e	0.450		0.018	
K	0.250		0.010	
K1	0.300		0.012	
K2	0.250		0.010	
K3	0.175		0.007	
K4	0.350		0.014	
K5	0.725		0.029	
L	0.350	0.450	0.014	0.018
L1	1.800	1.900	0.071	0.075
L2	2.225	2.325	0.088	0.092
L3	1.050	1.150	0.041	0.045

U-Type 10L QFN 3x3 (FC) Package

Richtek Technology Corporation

14F, No. 8, Tai Yuen 1st Street, Chupei City

Hsinchu, Taiwan, R.O.C.

Tel: (8863)5526789

RICHTEK

Richtek products are sold by description only. Richtek reserves the right to change the circuitry and/or specifications without notice at any time. Customers should obtain the latest relevant information and data sheets before placing orders and should verify that such information is current and complete. Richtek cannot assume responsibility for use of any circuitry other than circuitry entirely embodied in a Richtek product. Information furnished by Richtek is believed to be accurate and reliable. However, no responsibility is assumed by Richtek or its subsidiaries for its use; nor for any infringements of patents or other rights of third parties which may result from its use. No license is granted by implication or otherwise under any patent or patent rights of Richtek or its subsidiaries.