

2N7000 / 2N7002 / NDS7002A N-Channel Enhancement Mode Field Effect Transistor

General Description

These N-Channel enhancement mode field effect transistors are produced using Fairchild's proprietary, high cell density, DMOS technology. These products have been designed to minimize on-state resistance while provide rugged, reliable, and fast switching performance. They can be used in most applications requiring up to 400mA DC and can deliver pulsed currents up to 2A. These products are particularly suited for low voltage, low current applications such as small servo motor control, power MOSFET gate drivers, and other switching applications.

Features

- High density cell design for low $R_{DS(ON)}$.
- Voltage controlled small signal switch.
- Rugged and reliable.
- High saturation current capability.

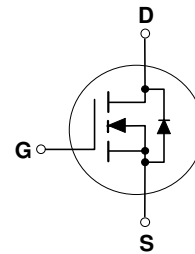
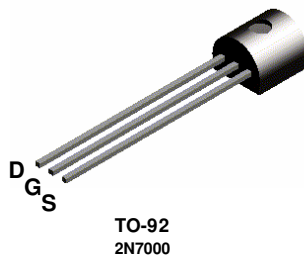

Absolute Maximum Ratings $T_A = 25^\circ\text{C}$ unless otherwise noted

Symbol	Parameter	2N7000	2N7002	NDS7002A	Units
V_{DSS}	Drain-Source Voltage	60			V
V_{DGR}	Drain-Gate Voltage ($R_{GS} \leq 1 \text{ M}\Omega$)	60			V
V_{GSS}	Gate-Source Voltage - Continuous	± 20			V
	- Non Repetitive ($t_p < 50\mu\text{s}$)	± 40			
I_D	Maximum Drain Current - Continuous	200	115	280	mA
	- Pulsed	500	800	1500	
P_D	Maximum Power Dissipation	400	200	300	mW
	Derated above 25°C	3.2	1.6	2.4	mW/ $^\circ\text{C}$
T_J, T_{STG}	Operating and Storage Temperature Range	-55 to 150			$^\circ\text{C}$
T_L	Maximum Lead Temperature for Soldering Purposes, 1/16" from Case for 10 Seconds	300			$^\circ\text{C}$

THERMAL CHARACTERISTICS

$R_{\theta JA}$	Thermal Resistance, Junction-to-Ambient	312.5	625	417	$^\circ\text{C}/\text{W}$
-----------------	---	-------	-----	-----	---------------------------

Electrical Characteristics $T_A = 25^\circ\text{C}$ unless otherwise noted

Symbol	Parameter	Conditions	Type	Min	Typ	Max	Units
OFF CHARACTERISTICS							
BV_{DSS}	Drain-Source Breakdown Voltage	$V_{GS} = 0\text{ V}, I_D = 10\ \mu\text{A}$	All	60			V
I_{DSS}	Zero Gate Voltage Drain Current	$V_{DS} = 48\text{ V}, V_{GS} = 0\text{ V}$	2N7000			1	μA
		$T_J = 125^\circ\text{C}$				1	mA
		$V_{DS} = 60\text{ V}, V_{GS} = 0\text{ V}$	2N7002 NDS7002A			1	μA
		$T_J = 125^\circ\text{C}$				0.5	mA
I_{GSSF}	Gate - Body Leakage, Forward	$V_{GS} = 15\text{ V}, V_{DS} = 0\text{ V}$	2N7000			10	nA
		$V_{GS} = 20\text{ V}, V_{DS} = 0\text{ V}$	2N7002 NDS7002A			100	nA
I_{GSSR}	Gate - Body Leakage, Reverse	$V_{GS} = -15\text{ V}, V_{DS} = 0\text{ V}$	2N7000			-10	nA
		$V_{GS} = -20\text{ V}, V_{DS} = 0\text{ V}$	2N7002 NDS7002A			-100	nA
ON CHARACTERISTICS (Note 1)							
$V_{GS(th)}$	Gate Threshold Voltage	$V_{DS} = V_{GS}, I_D = 1\text{ mA}$	2N7000	0.8	2.1	3	V
		$V_{DS} = V_{GS}, I_D = 250\ \mu\text{A}$	2N7002 NDS7002A	1	2.1	2.5	
$R_{DS(on)}$	Static Drain-Source On-Resistance	$V_{GS} = 10\text{ V}, I_D = 500\text{ mA}$	2N7000		1.2	5	Ω
		$T_J = 125^\circ\text{C}$			1.9	9	
		$V_{GS} = 4.5\text{ V}, I_D = 75\text{ mA}$	2N7002 NDS7002A		1.8	5.3	
		$V_{GS} = 10\text{ V}, I_D = 500\text{ mA}$			1.2	7.5	
		$T_J = 100^\circ\text{C}$			1.7	13.5	
		$V_{GS} = 5.0\text{ V}, I_D = 50\text{ mA}$			1.7	7.5	
		$T_J = 100^\circ\text{C}$			2.4	13.5	
		$V_{GS} = 10\text{ V}, I_D = 500\text{ mA}$		NDS7002A		1.2	
$T_J = 125^\circ\text{C}$		2	3.5				
$V_{GS} = 5.0\text{ V}, I_D = 50\text{ mA}$		1.7	3				
			2.8	5			
$V_{DS(on)}$	Drain-Source On-Voltage	$V_{GS} = 10\text{ V}, I_D = 500\text{ mA}$	2N7000		0.6	2.5	V
		$V_{GS} = 4.5\text{ V}, I_D = 75\text{ mA}$			0.14	0.4	
		$V_{GS} = 10\text{ V}, I_D = 500\text{ mA}$	2N7002		0.6	3.75	
		$V_{GS} = 5.0\text{ V}, I_D = 50\text{ mA}$			0.09	1.5	
		$V_{GS} = 10\text{ V}, I_D = 500\text{ mA}$	NDS7002A		0.6	1	
		$V_{GS} = 5.0\text{ V}, I_D = 50\text{ mA}$			0.09	0.15	

Electrical Characteristics $T_A = 25^\circ\text{C}$ unless otherwise noted

Symbol	Parameter	Conditions	Type	Min	Typ	Max	Units
ON CHARACTERISTICS Continued (Note 1)							
$I_{D(ON)}$	On-State Drain Current	$V_{GS} = 4.5\text{ V}, V_{DS} = 10\text{ V}$	2N7000	75	600		mA
		$V_{GS} = 10\text{ V}, V_{DS} \geq 2 V_{DS(on)}$	2N7002	500	2700		
		$V_{GS} = 10\text{ V}, V_{DS} \geq 2 V_{DS(on)}$	NDS7002A	500	2700		
g_{FS}	Forward Transconductance	$V_{DS} = 10\text{ V}, I_D = 200\text{ mA}$	2N7000	100	320		mS
		$V_{DS} \geq 2 V_{DS(on)}, I_D = 200\text{ mA}$	2N7002	80	320		
		$V_{DS} \geq 2 V_{DS(on)}, I_D = 200\text{ mA}$	NDS7002A	80	320		
DYNAMIC CHARACTERISTICS							
C_{iss}	Input Capacitance	$V_{DS} = 25\text{ V}, V_{GS} = 0\text{ V},$ $f = 1.0\text{ MHz}$	All		20	50	pF
C_{oss}	Output Capacitance		All		11	25	pF
C_{rss}	Reverse Transfer Capacitance		All		4	5	pF
t_{on}	Turn-On Time	$V_{DD} = 15\text{ V}, R_L = 25\ \Omega,$ $I_D = 500\text{ mA}, V_{GS} = 10\text{ V},$ $R_{GEN} = 25$	2N7000			10	ns
		$V_{DD} = 30\text{ V}, R_L = 150\ \Omega,$ $I_D = 200\text{ mA}, V_{GS} = 10\text{ V},$ $R_{GEN} = 25\ \Omega$	2N700 NDS7002A			20	
t_{off}	Turn-Off Time	$V_{DD} = 15\text{ V}, R_L = 25\ \Omega,$ $I_D = 500\text{ mA}, V_{GS} = 10\text{ V},$ $R_{GEN} = 25$	2N7000			10	ns
		$V_{DD} = 30\text{ V}, R_L = 150\ \Omega,$ $I_D = 200\text{ mA}, V_{GS} = 10\text{ V},$ $R_{GEN} = 25\ \Omega$	2N700 NDS7002A			20	
DRAIN-SOURCE DIODE CHARACTERISTICS AND MAXIMUM RATINGS							
I_S	Maximum Continuous Drain-Source Diode Forward Current		2N7002			115	mA
			NDS7002A			280	
I_{SM}	Maximum Pulsed Drain-Source Diode Forward Current		2N7002			0.8	A
			NDS7002A			1.5	
V_{SD}	Drain-Source Diode Forward Voltage	$V_{GS} = 0\text{ V}, I_S = 115\text{ mA}$ (Note 1)	2N7002		0.88	1.5	V
		$V_{GS} = 0\text{ V}, I_S = 400\text{ mA}$ (Note 1)	NDS7002A		0.88	1.2	

Note:

 1. Pulse Test: Pulse Width $\leq 300\ \mu\text{s}$, Duty Cycle $\leq 2.0\%$.

Typical Electrical Characteristics

2N7000 / 2N7002 / NDS7002A

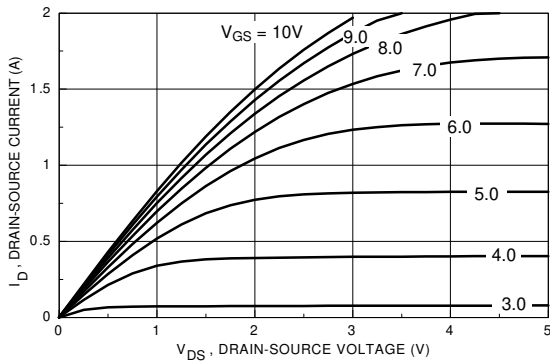

Figure 1. On-Region Characteristics

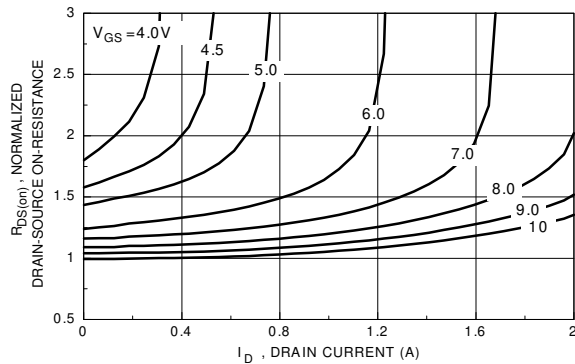

Figure 2. On-Resistance Variation with Gate Voltage and Drain Current

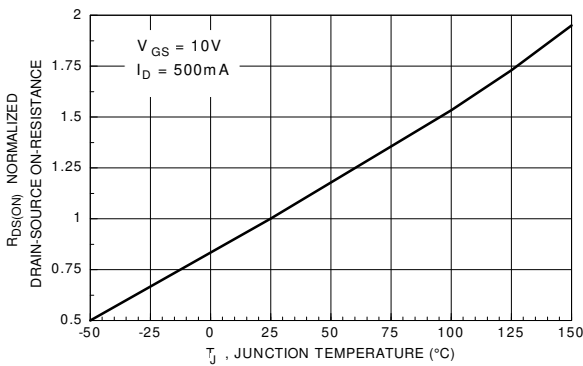

Figure 3. On-Resistance Variation with Temperature

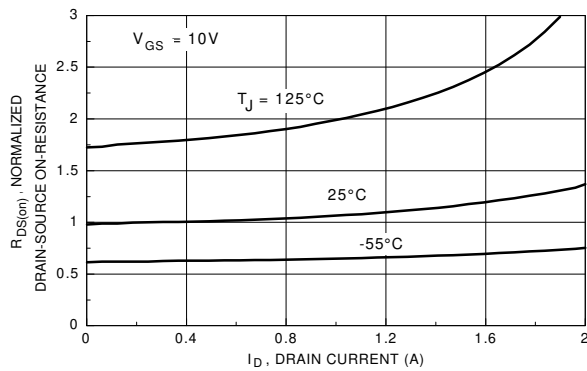

Figure 4. On-Resistance Variation with Drain Current and Temperature

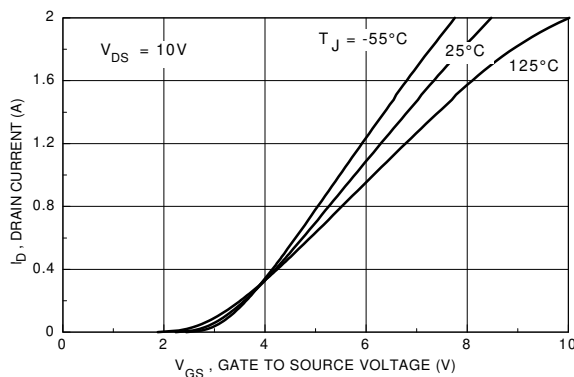

Figure 5. Transfer Characteristics

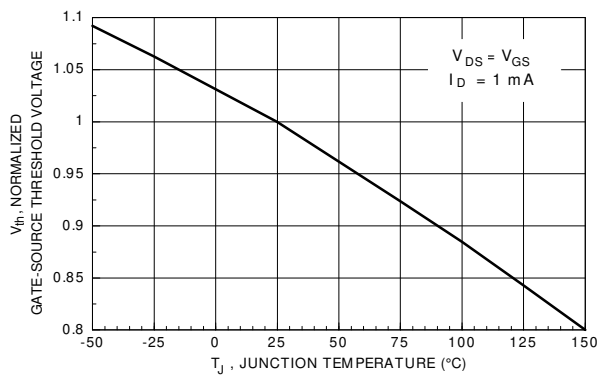

Figure 6. Gate Threshold Variation with Temperature

Typical Electrical Characteristics (continued)

2N7000 / 2N7002 / NDS7002A

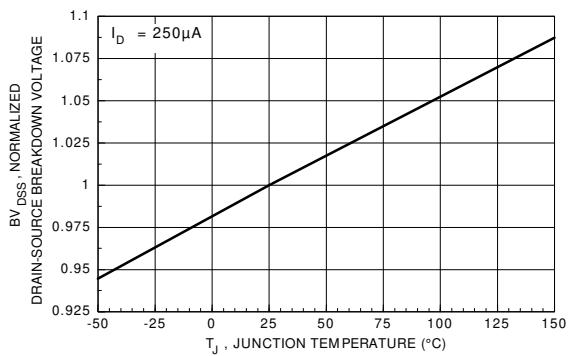

Figure 7. Breakdown Voltage Variation with Temperature

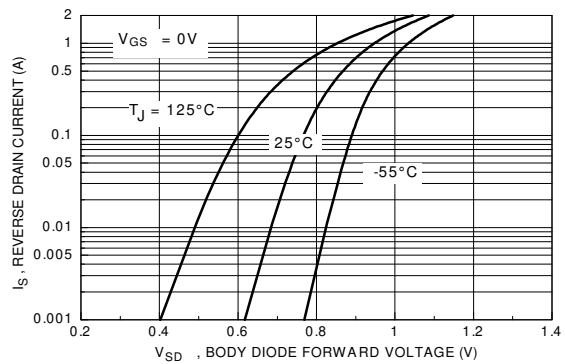

Figure 8. Body Diode Forward Voltage Variation with Temperature

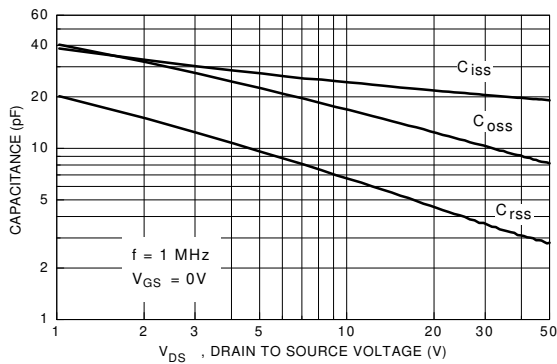

Figure 9. Capacitance Characteristics

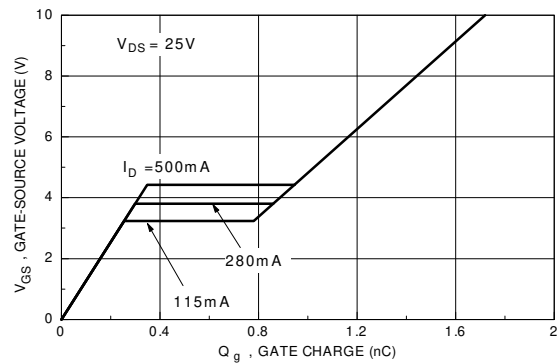

Figure 10. Gate Charge Characteristics

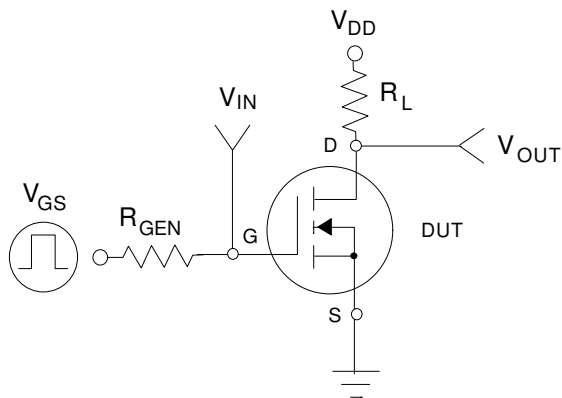

Figure 11.

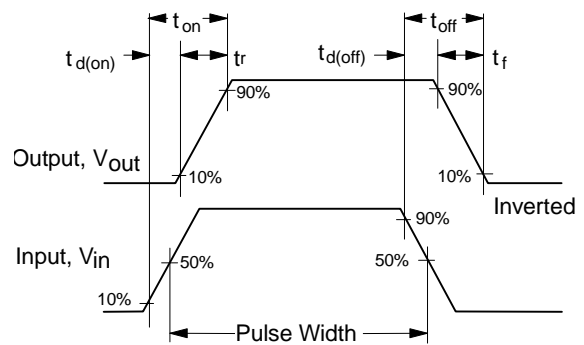

Figure 12. Switching Waveforms

Typical Electrical Characteristics (continued)

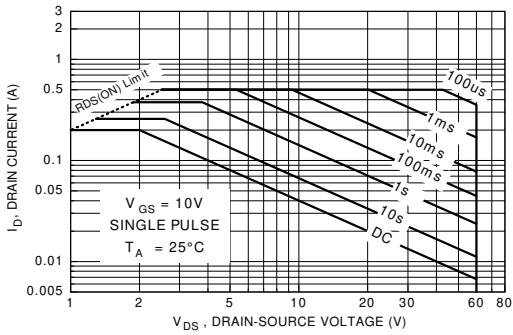

Figure 13. 2N7000 Maximum Safe Operating Area

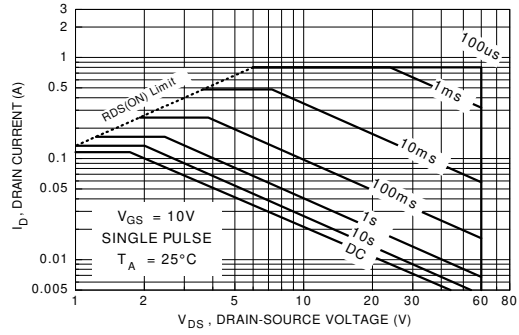

Figure 14. 2N7002 Maximum Safe Operating Area

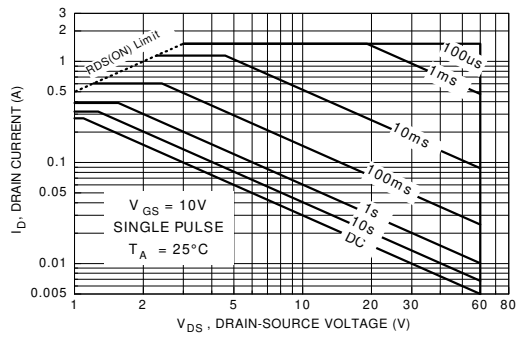

Figure 15. NDS7000A Maximum Safe Operating Area

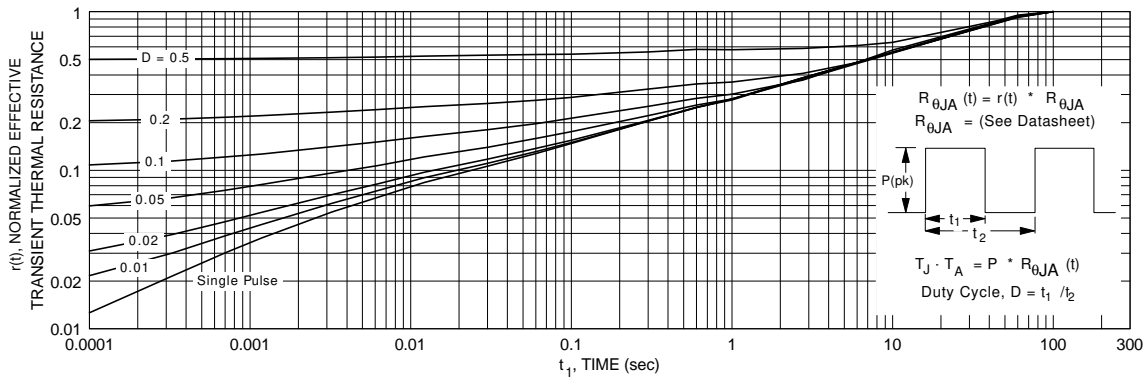

Figure 16. TO-92, 2N7000 Transient Thermal Response Curve

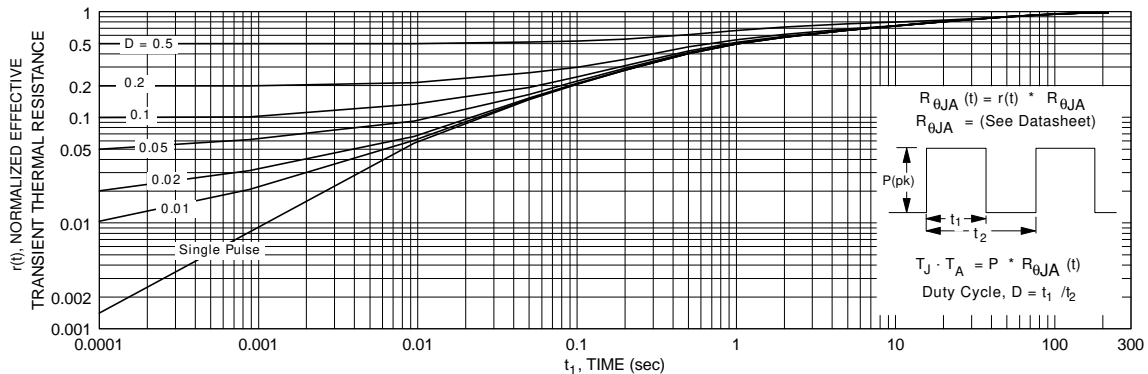

Figure 17. SOT-23, 2N7002 / NDS7002A Transient Thermal Response Curve

TRADEMARKS

The following are registered and unregistered trademarks Fairchild Semiconductor owns or is authorized to use and is not intended to be an exhaustive list of all such trademarks.

ACEx™	FASTr™	PowerTrench®	SyncFET™
Bottomless™	GlobalOptoisolator™	QFET™	TinyLogic™
CoolFET™	GTO™	QST™	UHC™
CROSSVOLT™	HiSeC™	QT Optoelectronics™	VCX™
DOME™	ISOPLANAR™	Quiet Series™	
E ² CMOS™	MICROWIRE™	SILENT SWITCHER®	
EnSigna™	OPTOLOGIC™	SMART START™	
FACT™	OPTOPLANAR™	SuperSOT™-3	
FACT Quiet Series™	PACMAN™	SuperSOT™-6	
FAST®	POP™	SuperSOT™-8	

DISCLAIMER

FAIRCHILD SEMICONDUCTOR RESERVES THE RIGHT TO MAKE CHANGES WITHOUT FURTHER NOTICE TO ANY PRODUCTS HEREIN TO IMPROVE RELIABILITY, FUNCTION OR DESIGN. FAIRCHILD DOES NOT ASSUME ANY LIABILITY ARISING OUT OF THE APPLICATION OR USE OF ANY PRODUCT OR CIRCUIT DESCRIBED HEREIN; NEITHER DOES IT CONVEY ANY LICENSE UNDER ITS PATENT RIGHTS, NOR THE RIGHTS OF OTHERS.

LIFE SUPPORT POLICY

FAIRCHILD'S PRODUCTS ARE NOT AUTHORIZED FOR USE AS CRITICAL COMPONENTS IN LIFE SUPPORT DEVICES OR SYSTEMS WITHOUT THE EXPRESS WRITTEN APPROVAL OF FAIRCHILD SEMICONDUCTOR CORPORATION. As used herein:

1. Life support devices or systems are devices or systems which, (a) are intended for surgical implant into the body, or (b) support or sustain life, or (c) whose failure to perform when properly used in accordance with instructions for use provided in the labeling, can be reasonably expected to result in significant injury to the user.
2. A critical component is any component of a life support device or system whose failure to perform can be reasonably expected to cause the failure of the life support device or system, or to affect its safety or effectiveness.

PRODUCT STATUS DEFINITIONS

Definition of Terms

Datasheet Identification	Product Status	Definition
Advance Information	Formative or In Design	This datasheet contains the design specifications for product development. Specifications may change in any manner without notice.
Preliminary	First Production	This datasheet contains preliminary data, and supplementary data will be published at a later date. Fairchild Semiconductor reserves the right to make changes at any time without notice in order to improve design.
No Identification Needed	Full Production	This datasheet contains final specifications. Fairchild Semiconductor reserves the right to make changes at any time without notice in order to improve design.
Obsolete	Not In Production	This datasheet contains specifications on a product that has been discontinued by Fairchild semiconductor. The datasheet is printed for reference information only.