

10 9 8 7 6 5 4 3 2 1

F

F

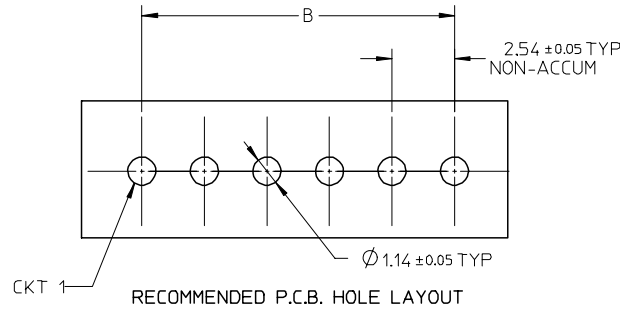
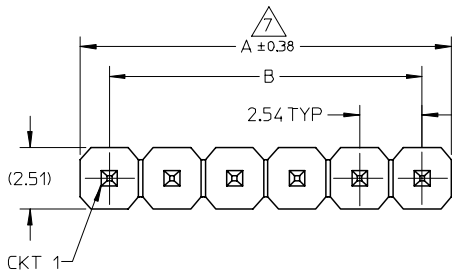

NOTES

1. MATERIAL:
HSG: NYLON, GLASS-FILLED, UL94V-0 COLOR: BLACK
PIN: 0.64MM SQ, COPPER ALLOY
2. PLATING TYPE:
 - (1) GOLD FLASH OVER
1.270µm MIN. NICKEL OVERALL.
 - (2) GOLD FLASH ON CONTACT AND
1.905µm MIN. TIN ON SOLDER TAIL OVER
1.270µm MIN. NICKEL OVERALL.
 - (3) 0.254µm MIN. GOLD PLATE ON CONTACT AND
1.905µm MIN. TIN ON SOLDER TAIL OVER
1.270µm MIN. NICKEL OVERALL.
 - (4) 0.381µm MIN. GOLD PLATE ON CONTACT AND
1.905µm MIN. TIN ON SOLDER TAIL OVER
1.270µm MIN. NICKEL OVERALL.
 - (5) 0.762µm MIN. GOLD PLATE ON CONTACT AND
1.905µm MIN. TIN ON SOLDER TAIL OVER
1.270µm MIN. NICKEL OVERALL.
 - (6) 2.540µm/100µm MIN TIN OVERALL
1.270µm/50µm NICKEL OVERALL
3. PRODUCT SPECIFICATION: PS-87920-019
4. PACKAGING TYPE: SEE TABLE
5. WAFER TO BE FLAT WITHIN 0.003 mm/mm
6. RECOMMENDED PCB THICKNESS IS 1.60mm±0.10
- △ IRREGULAR CIRCUIT CUTOFF WITHIN BREAKAWAY SECTION IS PERMISSIBLE. CUTTING OR CHIPPING OF THE MAIN BODY IS NOT ACCEPTABLE
8. THE ABOVE CKT 6 IS FOR ILLUSTRATION PURPOSE ONLY
9. PACKAGING SPECIFICATION:
TRAY: PK-89990-489
BULK: PK-89990-491

E

D

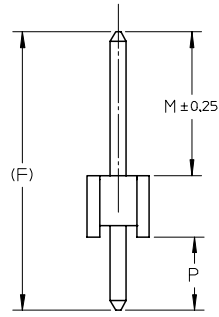
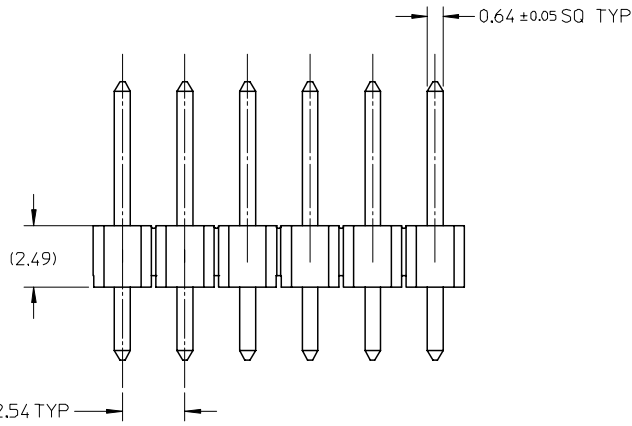

D

C

C

B

B

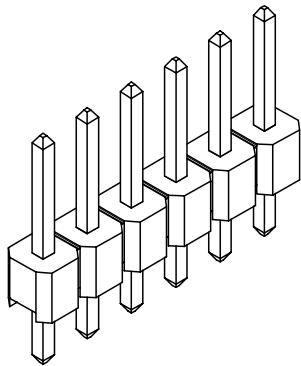

A

A



EWR# 1023 EC NO: S2007-0289 DRWN:SKLIM01 CHKD:CWAM APPR:KWLEE	2006/09/29 2006/09/29 2006/09/30	DESCRIPTION REV	QUALITY SYMBOLS	GENERAL TOLERANCES (UNLESS SPECIFIED)	DIMENSION STYLE	SCALE	DESIGN UNITS	THIRD ANGLE PROJECTION
			▽=0 ∇=0	mm INCH	MM ONLY	NTS	METRIC	
				4 PLACES ± --- ± --- 3 PLACES ± --- ± --- 2 PLACES ± 0.20 ± --- 1 PLACE ± --- ± ---	DRAWN BY DATE YLQ1A0 2004/11/17 CHECKED BY DATE PTL IM 2004/12/01 APPROVED BY DATE SCLOW 2004/12/06	TITLE		
				ANGULAR ± 3 °				
			DRAFT WHERE APPLICABLE MUST REMAIN WITHIN DIMENSIONS	SEE TABLE			CUSTOM HEADER 2.54MM PITCH, SINGLE ROW SINGLE WAFER, T/H HEADER	MOLEX INCORPORATED SD-87891-013
								SHEET NO. 1 OF 8

9 8 7 6 5 4 3 2 1



PACKAGING OPTION PART NO.										PACKAGING OPTION PART NO.											
TRAY	BULK	TUBE WITHOUT CAP	CKT SIZE	VOID POSITION	PLATING TYPE	DIMENSION					TRAY	BULK	TUBE WITHOUT CAP	CKT SIZE	VOID POSITION	PLATING TYPE	DIMENSION				
						A	B	F	M	P							A	B	F	M	P
87891-0101	-----	-----	1	-----	1	2.54	----	11.30	5.84	2.97	87891-0401	-----	-----	4	-----	1	10.16	7.62	11.30	5.84	2.97
87891-0102	-----	-----	1	-----	2	2.54	----	11.30	5.84	2.97	87891-0412	-----	-----	4	-----	2	10.16	7.62	11.30	5.84	2.97
87891-0103	-----	-----	1	-----	3	2.54	----	11.30	5.84	2.97	87891-0403	-----	-----	4	-----	3	10.16	7.62	11.30	5.84	2.97
87891-0104	-----	-----	1	-----	4	2.54	----	11.30	5.84	2.97	87891-0404	-----	-----	4	-----	4	10.16	7.62	11.30	5.84	2.97
87891-0105	-----	-----	1	-----	5	2.54	----	11.30	5.84	2.97	87891-0405	-----	-----	4	-----	5	10.16	7.62	11.30	5.84	2.97
87891-0106	-----	-----	1	-----	6	2.54	----	11.30	5.84	2.97	87891-0406	-----	-----	4	-----	6	10.16	7.62	11.30	5.84	2.97
87891-0201	-----	-----	2	-----	1	5.08	2.54	11.30	5.84	2.97	87891-0511	-----	-----	5	-----	1	12.70	10.16	11.30	5.84	2.97
87891-0202	-----	-----	2	-----	2	5.08	2.54	11.30	5.84	2.97	87891-0512	-----	-----	5	-----	2	12.70	10.16	11.30	5.84	2.97
87891-0203	-----	-----	2	-----	3	5.08	2.54	11.30	5.84	2.97	87891-0513	-----	-----	5	-----	3	12.70	10.16	11.30	5.84	2.97
87891-0204	-----	-----	2	-----	4	5.08	2.54	11.30	5.84	2.97	87891-0514	-----	-----	5	-----	4	12.70	10.16	11.30	5.84	2.97
87891-0205	-----	-----	2	-----	5	5.08	2.54	11.30	5.84	2.97	87891-0515	-----	-----	5	-----	5	12.70	10.16	11.30	5.84	2.97
87891-0206	-----	-----	2	-----	6	5.08	2.54	11.30	5.84	2.97	87891-0506	-----	-----	5	-----	6	12.70	10.16	11.30	5.84	2.97
87891-0301	-----	-----	3	-----	1	7.62	5.08	11.30	5.84	2.97	87891-0601	-----	-----	6	-----	1	15.24	12.70	11.30	5.84	2.97
87891-0302	-----	-----	3	-----	2	7.62	5.08	11.30	5.84	2.97	87891-0612	-----	-----	6	-----	2	15.24	12.70	11.30	5.84	2.97
87891-0303	-----	-----	3	-----	3	7.62	5.08	11.30	5.84	2.97	87891-0603	-----	-----	6	-----	3	15.24	12.70	11.30	5.84	2.97
87891-0304	-----	-----	3	-----	4	7.62	5.08	11.30	5.84	2.97	87891-0604	-----	-----	6	-----	4	15.24	12.70	11.30	5.84	2.97
87891-0305	-----	-----	3	-----	5	7.62	5.08	11.30	5.84	2.97	87891-0605	-----	-----	6	-----	5	15.24	12.70	11.30	5.84	2.97
87891-0306	-----	-----	3	-----	6	7.62	5.08	11.30	5.84	2.97	87891-0606	-----	-----	6	-----	6	15.24	12.70	11.30	5.84	2.97

EWR# 1023 EC NO: S2007-0289 DRWNS:KLI M01 2006/09/29 CHKD:CWJAM 2006/09/29 APPR:KWLEE 2006/09/30	QUALITY SYMBOLS =0 =0	GENERAL TOLERANCES (UNLESS SPECIFIED) <table border="1"> <tr><th></th><th>mm</th><th>INCH</th></tr> <tr><td>4 PLACES</td><td>± ---</td><td>± ---</td></tr> <tr><td>3 PLACES</td><td>± ---</td><td>± ---</td></tr> <tr><td>2 PLACES</td><td>± 0.20</td><td>± ---</td></tr> <tr><td>1 PLACE</td><td>± ---</td><td>± ---</td></tr> </table>		mm	INCH	4 PLACES	± ---	± ---	3 PLACES	± ---	± ---	2 PLACES	± 0.20	± ---	1 PLACE	± ---	± ---	DIMENSION STYLE MM ONLY	SCALE NTS	DESIGN UNITS METRIC	THIRD ANGLE PROJECTION
			mm	INCH																	
		4 PLACES	± ---	± ---																	
		3 PLACES	± ---	± ---																	
2 PLACES	± 0.20	± ---																			
1 PLACE	± ---	± ---																			
DRAWN BY YLQ1A0	DATE 2004/11/17	TITLE CUSTOM HEADER 2.54MM PITCH, SINGLE ROW SINGLE WAFER, T/H HEADER																			
CHECKED BY PTL IM	DATE 2004/12/01	MOLEX INCORPORATED																			
APPROVED BY SCLOW	DATE 2004/12/06	MATERIAL NO. SEE TABLE	DOCUMENT NO. SD-87891-013	SHEET NO. 2 OF 8																	

PACKAGING OPTION PART NO.		CKT SIZE	VOID POSITION	PLATING TYPE	DIMENSION					PACKAGING OPTION PART NO.		CKT SIZE	VOID POSITION	PLATING TYPE	DIMENSION							
TRAY	BULK				TUBE WITHOUT CAP	A	B	F	M	P	TRAY				BULK	TUBE WITHOUT CAP	A	B	F	M	P	
F	87891-0711	-----	-----	7	----	1	17.78	15.24	11.30	5.84	2.97	87891-1001	-----	-----	10	----	1	25.40	22.86	11.30	5.84	2.97
	87891-0702	-----	-----	7	----	2	17.78	15.24	11.30	5.84	2.97	87891-1002	-----	-----	10	----	2	25.40	22.86	11.30	5.84	2.97
	87891-0703	-----	-----	7	----	3	17.78	15.24	11.30	5.84	2.97	87891-1003	-----	-----	10	----	3	25.40	22.86	11.30	5.84	2.97
	87891-0704	-----	-----	7	----	4	17.78	15.24	11.30	5.84	2.97	87891-1004	-----	-----	10	----	4	25.40	22.86	11.30	5.84	2.97
	87891-0705	-----	-----	7	----	5	17.78	15.24	11.30	5.84	2.97	87891-1005	-----	-----	10	----	5	25.40	22.86	11.30	5.84	2.97
	87891-0706	-----	-----	7	----	6	17.78	15.24	11.30	5.84	2.97	87891-1006	-----	-----	10	----	6	25.40	22.86	11.30	5.84	2.97
E																						
	87891-0801	-----	-----	8	----	1	20.32	17.78	11.30	5.84	2.97	87891-1101	-----	-----	11	----	1	27.94	25.40	11.30	5.84	2.97
	87891-0802	-----	-----	8	----	2	20.32	17.78	11.30	5.84	2.97	87891-1102	-----	-----	11	----	2	27.94	25.40	11.30	5.84	2.97
	87891-0803	-----	-----	8	----	3	20.32	17.78	11.30	5.84	2.97	87891-1103	-----	-----	11	----	3	27.94	25.40	11.30	5.84	2.97
	87891-0804	-----	-----	8	----	4	20.32	17.78	11.30	5.84	2.97	87891-1104	-----	-----	11	----	4	27.94	25.40	11.30	5.84	2.97
D	87891-0805	-----	-----	8	----	5	20.32	17.78	11.30	5.84	2.97	87891-1105	-----	-----	11	----	5	27.94	25.40	11.30	5.84	2.97
	87891-0806	-----	-----	8	----	6	20.32	17.78	11.30	5.84	2.97	87891-1106	-----	-----	11	----	6	27.94	25.40	11.30	5.84	2.97
	87891-0901	-----	-----	9	----	1	22.86	20.32	11.30	5.84	2.97	87891-1201	-----	-----	12	----	1	30.48	27.94	11.30	5.84	2.97
	87891-0902	-----	-----	9	----	2	22.86	20.32	11.30	5.84	2.97	87891-1202	-----	-----	12	----	2	30.48	27.94	11.30	5.84	2.97
C	87891-0903	-----	-----	9	----	3	22.86	20.32	11.30	5.84	2.97	87891-1203	-----	-----	12	----	3	30.48	27.94	11.30	5.84	2.97
	87891-0904	-----	-----	9	----	4	22.86	20.32	11.30	5.84	2.97	87891-1204	-----	-----	12	----	4	30.48	27.94	11.30	5.84	2.97
	87891-0905	-----	-----	9	----	5	22.86	20.32	11.30	5.84	2.97	87891-1205	-----	-----	12	----	5	30.48	27.94	11.30	5.84	2.97
	87891-0906	-----	-----	9	----	6	22.86	20.32	11.30	5.84	2.97	87891-1206	-----	-----	12	----	6	30.48	27.94	11.30	5.84	2.97
B																						

QUALITY SYMBOLS  = 0  = 0.05	GENERAL TOLERANCES (UNLESS SPECIFIED) <table border="1"> <tr><th></th><th>mm</th><th>INCH</th></tr> <tr><td>4 PLACES</td><td>± .---</td><td>± .---</td></tr> <tr><td>3 PLACES</td><td>± .---</td><td>± .---</td></tr> <tr><td>2 PLACES</td><td>± 0.20</td><td>± .---</td></tr> <tr><td>1 PLACE</td><td>± .---</td><td>± .---</td></tr> </table>		mm	INCH	4 PLACES	± .---	± .---	3 PLACES	± .---	± .---	2 PLACES	± 0.20	± .---	1 PLACE	± .---	± .---	DIMENSION STYLE MM ONLY	SCALE NTS	DESIGN UNITS METRIC	 THIRD ANGLE PROJECTION										
		mm	INCH																											
	4 PLACES	± .---	± .---																											
	3 PLACES	± .---	± .---																											
2 PLACES	± 0.20	± .---																												
1 PLACE	± .---	± .---																												
DESCRIPTION EWR# 1023 EC NO: S2007-0289 DRWNS:KLI M01 2006/09/29 CHKD:CWJAM 2006/09/29 APPR:KWLEE 2006/09/30	DRAFT WHERE APPLICABLE MUST REMAIN WITHIN DIMENSIONS	<table border="1"> <tr><td>DRAWN BY</td><td>DATE</td></tr> <tr><td>YLQ1A0</td><td>2004/11/17</td></tr> <tr><td>CHECKED BY</td><td>DATE</td></tr> <tr><td>PTL IM</td><td>2004/12/01</td></tr> <tr><td>APPROVED BY</td><td>DATE</td></tr> <tr><td>SCLOW</td><td>2004/12/06</td></tr> </table>	DRAWN BY	DATE	YLQ1A0	2004/11/17	CHECKED BY	DATE	PTL IM	2004/12/01	APPROVED BY	DATE	SCLOW	2004/12/06	<table border="1"> <tr><td colspan="2">TITLE</td></tr> <tr><td colspan="2">CUSTOM HEADER</td></tr> <tr><td colspan="2">2.54MM PITCH, SINGLE ROW</td></tr> <tr><td colspan="2">SINGLE WAFER, T/H HEADER</td></tr> <tr><td colspan="2">MOLEX INCORPORATED</td></tr> <tr><td>MATERIAL NO.</td><td>DOCUMENT NO.</td></tr> <tr><td>SEE TABLE</td><td>SD-87891-013</td></tr> </table>	TITLE		CUSTOM HEADER		2.54MM PITCH, SINGLE ROW		SINGLE WAFER, T/H HEADER		MOLEX INCORPORATED		MATERIAL NO.	DOCUMENT NO.	SEE TABLE	SD-87891-013	SHEET NO. 3 OF 8
DRAWN BY	DATE																													
YLQ1A0	2004/11/17																													
CHECKED BY	DATE																													
PTL IM	2004/12/01																													
APPROVED BY	DATE																													
SCLOW	2004/12/06																													
TITLE																														
CUSTOM HEADER																														
2.54MM PITCH, SINGLE ROW																														
SINGLE WAFER, T/H HEADER																														
MOLEX INCORPORATED																														
MATERIAL NO.	DOCUMENT NO.																													
SEE TABLE	SD-87891-013																													
SIZE A3	THIS DRAWING CONTAINS INFORMATION THAT IS PROPRIETARY TO MOLEX INCORPORATED AND SHOULD NOT BE USED WITHOUT WRITTEN PERMISSION																													

PACKAGING OPTION PART NO.										PACKAGING OPTION PART NO.											
TRAY	BULK	TUBE WITHOUT CAP	CKT SIZE	VOID POSITION	PLATING TYPE	DIMENSION					TRAY	BULK	TUBE WITHOUT CAP	CKT SIZE	VOID POSITION	PLATING TYPE	DIMENSION				
						A	B	F	M	P							A	B	F	M	P
87891-1301	-----	-----	13	-----	1	33.02	30.48	11.30	5.84	2.97	87891-1601	-----	-----	16	-----	1	40.64	38.10	11.30	5.84	2.97
87891-1302	-----	-----	13	-----	2	33.02	30.48	11.30	5.84	2.97	87891-1602	-----	-----	16	-----	2	40.64	38.10	11.30	5.84	2.97
87891-1303	-----	-----	13	-----	3	33.02	30.48	11.30	5.84	2.97	87891-1603	-----	-----	16	-----	3	40.64	38.10	11.30	5.84	2.97
87891-1304	-----	-----	13	-----	4	33.02	30.48	11.30	5.84	2.97	87891-1604	-----	-----	16	-----	4	40.64	38.10	11.30	5.84	2.97
87891-1305	-----	-----	13	-----	5	33.02	30.48	11.30	5.84	2.97	87891-1605	-----	-----	16	-----	5	40.64	38.10	11.30	5.84	2.97
87891-1306	-----	-----	13	-----	6	33.02	30.48	11.30	5.84	2.97	87891-1606	-----	-----	16	-----	6	40.64	38.10	11.30	5.84	2.97
87891-1401	-----	-----	14	-----	1	35.56	33.02	11.30	5.84	2.97	87891-1701	-----	-----	17	-----	1	43.18	40.64	11.30	5.84	2.97
87891-1402	-----	-----	14	-----	2	35.56	33.02	11.30	5.84	2.97	87891-1702	-----	-----	17	-----	2	43.18	40.64	11.30	5.84	2.97
87891-1403	-----	-----	14	-----	3	35.56	33.02	11.30	5.84	2.97	87891-1703	-----	-----	17	-----	3	43.18	40.64	11.30	5.84	2.97
87891-1404	-----	-----	14	-----	4	35.56	33.02	11.30	5.84	2.97	87891-1704	-----	-----	17	-----	4	43.18	40.64	11.30	5.84	2.97
87891-1405	-----	-----	14	-----	5	35.56	33.02	11.30	5.84	2.97	87891-1705	-----	-----	17	-----	5	43.18	40.64	11.30	5.84	2.97
87891-1406	-----	-----	14	-----	6	35.56	33.02	11.30	5.84	2.97	87891-1706	-----	-----	17	-----	6	43.18	40.64	11.30	5.84	2.97
87891-1501	-----	-----	15	-----	1	38.10	35.56	11.30	5.84	2.97	87891-1801	-----	-----	18	-----	1	45.72	43.18	11.30	5.84	2.97
87891-1502	-----	-----	15	-----	2	38.10	35.56	11.30	5.84	2.97	87891-1802	-----	-----	18	-----	2	45.72	43.18	11.30	5.84	2.97
87891-1503	-----	-----	15	-----	3	38.10	35.56	11.30	5.84	2.97	87891-1803	-----	-----	18	-----	3	45.72	43.18	11.30	5.84	2.97
87891-1504	-----	-----	15	-----	4	38.10	35.56	11.30	5.84	2.97	87891-1804	-----	-----	18	-----	4	45.72	43.18	11.30	5.84	2.97
87891-1505	-----	-----	15	-----	5	38.10	35.56	11.30	5.84	2.97	87891-1805	-----	-----	18	-----	5	45.72	43.18	11.30	5.84	2.97
87891-1506	-----	-----	15	-----	6	38.10	35.56	11.30	5.84	2.97	87891-1806	-----	-----	18	-----	6	45.72	43.18	11.30	5.84	2.97

QUALITY SYMBOLS  = 0  = 0.25	DESCRIPTION EWR# 1023 EC NO: S2007-0289 DRWNS:KLI M01 2006/09/29 CHKD:CWJAM 2006/09/29 APPR:KWLEE 2006/09/30	GENERAL TOLERANCES (UNLESS SPECIFIED)		DIMENSION STYLE MM ONLY		SCALE NTS	DESIGN UNITS METRIC	 THIRD ANGLE PROJECTION																										
		<table border="1"> <tr><th></th><th>mm</th><th>INCH</th></tr> <tr><td>4 PLACES</td><td>± ---</td><td>± ---</td></tr> <tr><td>3 PLACES</td><td>± ---</td><td>± ---</td></tr> <tr><td>2 PLACES</td><td>± 0.20</td><td>± ---</td></tr> <tr><td>1 PLACE</td><td>± ---</td><td>± ---</td></tr> </table>			mm	INCH	4 PLACES	± ---	± ---	3 PLACES	± ---	± ---	2 PLACES	± 0.20	± ---	1 PLACE	± ---	± ---	<table border="1"> <tr><th>DRAWN BY</th><th>DATE</th></tr> <tr><td>YLQIAO</td><td>2004/11/17</td></tr> <tr><th>CHECKED BY</th><th>DATE</th></tr> <tr><td>PTL IM</td><td>2004/12/01</td></tr> <tr><th>APPROVED BY</th><th>DATE</th></tr> <tr><td>SCLOW</td><td>2004/12/06</td></tr> </table>		DRAWN BY	DATE	YLQIAO	2004/11/17	CHECKED BY	DATE	PTL IM	2004/12/01	APPROVED BY	DATE	SCLOW	2004/12/06	TITLE CUSTOM HEADER 2.54MM PITCH, SINGLE ROW SINGLE WAFER, T/H HEADER	
			mm	INCH																														
		4 PLACES	± ---	± ---																														
3 PLACES	± ---	± ---																																
2 PLACES	± 0.20	± ---																																
1 PLACE	± ---	± ---																																
DRAWN BY	DATE																																	
YLQIAO	2004/11/17																																	
CHECKED BY	DATE																																	
PTL IM	2004/12/01																																	
APPROVED BY	DATE																																	
SCLOW	2004/12/06																																	
ANGULAR ± 3 °		MATERIAL NO. SEE TABLE		DOCUMENT NO. SD-87891-013		SHEET NO. 4 OF 8																												
DRAFT WHERE APPLICABLE MUST REMAIN WITHIN DIMENSIONS				THIS DRAWING CONTAINS INFORMATION THAT IS PROPRIETARY TO MOLEX INCORPORATED AND SHOULD NOT BE USED WITHOUT WRITTEN PERMISSION																														

PACKAGING OPTION PART NO.		CKT SIZE	VOID POSITION	PLATING TYPE	DIMENSION					PACKAGING OPTION PART NO.		CKT SIZE	VOID POSITION	PLATING TYPE	DIMENSION							
TRAY	BULK				TUBE WITHOUT CAP	A	B	F	M	P	TRAY				BULK	TUBE WITHOUT CAP	A	B	F	M	P	
F	87891-1901	-----	-----	19	----	1	48.26	45.72	11.30	5.84	2.97	87891-2201	-----	-----	22	----	1	55.88	53.34	11.30	5.84	2.97
	87891-1902	-----	-----	19	----	2	48.26	45.72	11.30	5.84	2.97	87891-2202	-----	-----	22	----	2	55.88	53.34	11.30	5.84	2.97
	87891-1903	-----	-----	19	----	3	48.26	45.72	11.30	5.84	2.97	87891-2203	-----	-----	22	----	3	55.88	53.34	11.30	5.84	2.97
	87891-1904	-----	-----	19	----	4	48.26	45.72	11.30	5.84	2.97	87891-2204	-----	-----	22	----	4	55.88	53.34	11.30	5.84	2.97
	87891-1905	-----	-----	19	----	5	48.26	45.72	11.30	5.84	2.97	87891-2205	-----	-----	22	----	5	55.88	53.34	11.30	5.84	2.97
	87891-1906	-----	-----	19	----	6	48.26	45.72	11.30	5.84	2.97	87891-2206	-----	-----	22	----	6	55.88	53.34	11.30	5.84	2.97
E																						
	87891-2001	-----	-----	20	----	1	50.80	48.26	11.30	5.84	2.97	87891-2301	-----	-----	23	----	1	58.42	55.88	11.30	5.84	2.97
	87891-2002	-----	-----	20	----	2	50.80	48.26	11.30	5.84	2.97	87891-2302	-----	-----	23	----	2	58.42	55.88	11.30	5.84	2.97
	87891-2003	-----	-----	20	----	3	50.80	48.26	11.30	5.84	2.97	87891-2303	-----	-----	23	----	3	58.42	55.88	11.30	5.84	2.97
	87891-2004	-----	-----	20	----	4	50.80	48.26	11.30	5.84	2.97	87891-2304	-----	-----	23	----	4	58.42	55.88	11.30	5.84	2.97
D	87891-2005	-----	-----	20	----	5	50.80	48.26	11.30	5.84	2.97	87891-2305	-----	-----	23	----	5	58.42	55.88	11.30	5.84	2.97
	87891-2006	-----	-----	20	----	6	50.80	48.26	11.30	5.84	2.97	87891-2306	-----	-----	23	----	6	58.42	55.88	11.30	5.84	2.97
	87891-2101	-----	-----	21	----	1	53.34	50.80	11.30	5.84	2.97	87891-2401	-----	-----	24	----	1	60.96	58.42	11.30	5.84	2.97
	87891-2102	-----	-----	21	----	2	53.34	50.80	11.30	5.84	2.97	87891-2402	-----	-----	24	----	2	60.96	58.42	11.30	5.84	2.97
C	87891-2103	-----	-----	21	----	3	53.34	50.80	11.30	5.84	2.97	87891-2403	-----	-----	24	----	3	60.96	58.42	11.30	5.84	2.97
	87891-2104	-----	-----	21	----	4	53.34	50.80	11.30	5.84	2.97	87891-2404	-----	-----	24	----	4	60.96	58.42	11.30	5.84	2.97
	87891-2105	-----	-----	21	----	5	53.34	50.80	11.30	5.84	2.97	87891-2405	-----	-----	24	----	5	60.96	58.42	11.30	5.84	2.97
	87891-2106	-----	-----	21	----	6	53.34	50.80	11.30	5.84	2.97	87891-2406	-----	-----	24	----	6	60.96	58.42	11.30	5.84	2.97
B																						

EWB# 1023 EC NO: S2007-0289 DRWNS:SKLIM01 2006/09/29 CHKD:CWLAM 2006/09/29 APPR:KWLEE 2006/09/30	QUALITY SYMBOLS =0 =0	GENERAL TOLERANCES (UNLESS SPECIFIED)		DIMENSION STYLE MM ONLY		SCALE NTS	DESIGN UNITS METRIC	THIRD ANGLE PROJECTION			
		4 PLACES ± --- ± --- 3 PLACES ± --- ± --- 2 PLACES ± 0.20 ± --- 1 PLACE ± --- ± ---	mm INCH	DRAWN BY YLQ1A0	DATE 2004/11/17	TITLE CUSTOM HEADER 2.54MM PITCH, SINGLE ROW SINGLE WAFER, T/H HEADER					
		ANGULAR ± 3 °		CHECKED BY PTLIM	DATE 2004/12/01	MOLEX INCORPORATED					
		DRAFT WHERE APPLICABLE MUST REMAIN WITHIN DIMENSIONS		APPROVED BY SCLOW	DATE 2004/12/06	MATERIAL NO. SEE TABLE	DOCUMENT NO. SD-87891-013	SHEET NO. 5 OF 8			

PACKAGING OPTION PART NO.		CKT SIZE	VOID POSITION	PLATING TYPE	DIMENSION					PACKAGING OPTION PART NO.		CKT SIZE	VOID POSITION	PLATING TYPE	DIMENSION							
TRAY	BULK				TUBE WITHOUT CAP	A	B	F	M	P	TRAY				BULK	TUBE WITHOUT CAP	A	B	F	M	P	
F	87891-2501	-----	-----	25	----	1	63.50	60.96	11.30	5.84	2.97	-----	87891-2801	-----	28	----	1	71.12	68.58	11.30	5.84	2.97
	87891-2502	-----	-----	25	----	2	63.50	60.96	11.30	5.84	2.97	-----	87891-2802	-----	28	----	2	71.12	68.58	11.30	5.84	2.97
	87891-2503	-----	-----	25	----	3	63.50	60.96	11.30	5.84	2.97	-----	87891-2803	-----	28	----	3	71.12	68.58	11.30	5.84	2.97
	87891-2504	-----	-----	25	----	4	63.50	60.96	11.30	5.84	2.97	-----	87891-2804	-----	28	----	4	71.12	68.58	11.30	5.84	2.97
	87891-2505	-----	-----	25	----	5	63.50	60.96	11.30	5.84	2.97	-----	87891-2805	-----	28	----	5	71.12	68.58	11.30	5.84	2.97
	87891-2506	-----	-----	25	----	6	63.50	60.96	11.30	5.84	2.97	-----	87891-2806	-----	28	----	6	71.12	68.58	11.30	5.84	2.97
E																						
	-----	87891-2611	-----	26	----	1	66.04	63.50	11.30	5.84	2.97	-----	87891-2901	-----	29	----	1	73.66	71.12	11.30	5.84	2.97
	-----	87891-2602	-----	26	----	2	66.04	63.50	11.30	5.84	2.97	-----	87891-2902	-----	29	----	2	73.66	71.12	11.30	5.84	2.97
	-----	87891-2603	-----	26	----	3	66.04	63.50	11.30	5.84	2.97	-----	87891-2903	-----	29	----	3	73.66	71.12	11.30	5.84	2.97
	-----	87891-2604	-----	26	----	4	66.04	63.50	11.30	5.84	2.97	-----	87891-2904	-----	29	----	4	73.66	71.12	11.30	5.84	2.97
D	-----	87891-2605	-----	26	----	5	66.04	63.50	11.30	5.84	2.97	-----	87891-2905	-----	29	----	5	73.66	71.12	11.30	5.84	2.97
	-----	87891-2606	-----	26	----	6	66.04	63.50	11.30	5.84	2.97	-----	87891-2906	-----	29	----	6	73.66	71.12	11.30	5.84	2.97
	-----	87891-2701	-----	27	----	1	68.58	66.04	11.30	5.84	2.97	-----	87891-3001	-----	30	----	1	76.20	73.66	11.30	5.84	2.97
	-----	87891-2702	-----	27	----	2	68.58	66.04	11.30	5.84	2.97	-----	87891-3002	-----	30	----	2	76.20	73.66	11.30	5.84	2.97
C	-----	87891-2703	-----	27	----	3	68.58	66.04	11.30	5.84	2.97	-----	87891-3003	-----	30	----	3	76.20	73.66	11.30	5.84	2.97
	-----	87891-2704	-----	27	----	4	68.58	66.04	11.30	5.84	2.97	-----	87891-3004	-----	30	----	4	76.20	73.66	11.30	5.84	2.97
	-----	87891-2705	-----	27	----	5	68.58	66.04	11.30	5.84	2.97	-----	87891-3005	-----	30	----	5	76.20	73.66	11.30	5.84	2.97
	-----	87891-2706	-----	27	----	6	68.58	66.04	11.30	5.84	2.97	-----	87891-3006	-----	30	----	6	76.20	73.66	11.30	5.84	2.97
B																						

EWR# 1023 EC NO: S2007-0289 DRWNS:KLI M01 2006/09/29 CHKD:CWJAM 2006/09/29 APPR:KWLEE 2006/09/30	QUALITY SYMBOLS =0 =0	GENERAL TOLERANCES (UNLESS SPECIFIED)		DIMENSION STYLE MM ONLY		SCALE NTS	DESIGN UNITS METRIC	THIRD ANGLE PROJECTION			
		4 PLACES ± --- ± --- 3 PLACES ± --- ± --- 2 PLACES ± 0.20 ± --- 1 PLACE ± --- ± ---	mm INCH	DRAWN BY YLQ1A0	DATE 2004/11/17	TITLE CUSTOM HEADER 2.54MM PITCH, SINGLE ROW SINGLE WAFER, T/H HEADER		MOLEX INCORPORATED		SHEET NO. 6 OF 8	
		ANGULAR ± 3 °		APPROVED BY SCLOW	DATE 2004/12/06	MATERIAL NO. SEE TABLE		DOCUMENT NO. SD-87891-013		DRAFT WHERE APPLICABLE MUST REMAIN WITHIN DIMENSIONS	
		DRAFT WHERE APPLICABLE MUST REMAIN WITHIN DIMENSIONS		THIS DRAWING CONTAINS INFORMATION THAT IS PROPRIETARY TO MOLEX INCORPORATED AND SHOULD NOT BE USED WITHOUT WRITTEN PERMISSION							

PACKAGING OPTION PART NO.										PACKAGING OPTION PART NO.											
TRAY	BULK	TUBE WITHOUT CAP	CKT SIZE	VOID POSITION	PLATING TYPE	DIMENSION					TRAY	BULK	TUBE WITHOUT CAP	CKT SIZE	VOID POSITION	PLATING TYPE	DIMENSION				
						A	B	F	M	P							A	B	F	M	P
-----	87891-3101	-----	31	-----	1	78.74	76.20	11.30	5.84	2.97	-----	87891-3401	-----	34	-----	1	86.36	83.82	11.30	5.84	2.97
-----	87891-3102	-----	31	-----	2	78.74	76.20	11.30	5.84	2.97	-----	87891-3402	-----	34	-----	2	86.36	83.82	11.30	5.84	2.97
-----	87891-3103	-----	31	-----	3	78.74	76.20	11.30	5.84	2.97	-----	87891-3403	-----	34	-----	3	86.36	83.82	11.30	5.84	2.97
-----	87891-3104	-----	31	-----	4	78.74	76.20	11.30	5.84	2.97	-----	87891-3404	-----	34	-----	4	86.36	83.82	11.30	5.84	2.97
-----	87891-3105	-----	31	-----	5	78.74	76.20	11.30	5.84	2.97	-----	87891-3405	-----	34	-----	5	86.36	83.82	11.30	5.84	2.97
-----	87891-3106	-----	31	-----	6	78.74	76.20	11.30	5.84	2.97	-----	87891-3406	-----	34	-----	6	86.36	83.82	11.30	5.84	2.97
-----		-----		-----							-----		-----		-----						
-----	87891-3201	-----	32	-----	1	81.28	78.74	11.30	5.84	2.97	-----	87891-3501	-----	35	-----	1	88.90	86.36	11.30	5.84	2.97
-----	87891-3202	-----	32	-----	2	81.28	78.74	11.30	5.84	2.97	-----	87891-3502	-----	35	-----	2	88.90	86.36	11.30	5.84	2.97
-----	87891-3203	-----	32	-----	3	81.28	78.74	11.30	5.84	2.97	-----	87891-3503	-----	35	-----	3	88.90	86.36	11.30	5.84	2.97
-----	87891-3204	-----	32	-----	4	81.28	78.74	11.30	5.84	2.97	-----	87891-3504	-----	35	-----	4	88.90	86.36	11.30	5.84	2.97
-----	87891-3205	-----	32	-----	5	81.28	78.74	11.30	5.84	2.97	-----	87891-3505	-----	35	-----	5	88.90	86.36	11.30	5.84	2.97
-----	87891-3206	-----	32	-----	6	81.28	78.74	11.30	5.84	2.97	-----	87891-3506	-----	35	-----	6	88.90	86.36	11.30	5.84	2.97
-----		-----		-----							-----		-----		-----						
-----	87891-3301	-----	33	-----	1	83.82	81.28	11.30	5.84	2.97	-----	87891-3611	-----	36	-----	1	91.44	88.90	11.30	5.84	2.97
-----	87891-3302	-----	33	-----	2	83.82	81.28	11.30	5.84	2.97	-----	87891-3602	-----	36	-----	2	91.44	88.90	11.30	5.84	2.97
-----	87891-3303	-----	33	-----	3	83.82	81.28	11.30	5.84	2.97	-----	87891-3603	-----	36	-----	3	91.44	88.90	11.30	5.84	2.97
-----	87891-3304	-----	33	-----	4	83.82	81.28	11.30	5.84	2.97	-----	87891-3604	-----	36	-----	4	91.44	88.90	11.30	5.84	2.97
-----	87891-3305	-----	33	-----	5	83.82	81.28	11.30	5.84	2.97	-----	87891-3605	-----	36	-----	5	91.44	88.90	11.30	5.84	2.97
-----	87891-3306	-----	33	-----	6	83.82	81.28	11.30	5.84	2.97	-----	87891-3606	-----	36	-----	6	91.44	88.90	11.30	5.84	2.97
-----		-----		-----							-----		-----		-----						
-----		-----		-----							-----		-----		-----						
-----		-----		-----							-----		-----		-----						

EWB# 1023 EC NO: S2007-0289 DRWNS:KLI M01 2006/09/29 CHKD:CWJAM 2006/09/29 APPR:KWLEE 2006/09/30	QUALITY SYMBOLS =0 =0	GENERAL TOLERANCES (UNLESS SPECIFIED)		DIMENSION STYLE MM ONLY		SCALE NTS	DESIGN UNITS METRIC	THIRD ANGLE PROJECTION			
		4 PLACES ± --- ± --- 3 PLACES ± --- ± --- 2 PLACES ± 0.20 ± --- 1 PLACE ± --- ± ---	mm INCH	DRAWN BY YLQ1A0	DATE 2004/11/17	TITLE CUSTOM HEADER 2.54MM PITCH, SINGLE ROW SINGLE WAFER, T/H HEADER					
		ANGULAR ± 3 °		CHECKED BY PTL IM	DATE 2004/12/01	MOLEX INCORPORATED					
		DRAFT WHERE APPLICABLE MUST REMAIN WITHIN DIMENSIONS		APPROVED BY SCLOW	DATE 2004/12/06	MATERIAL NO. SEE TABLE	DOCUMENT NO. SD-87891-013	SHEET NO. 7 OF 8			

PACKAGING OPTION PART NO.										PACKAGING OPTION PART NO.												
TRAY	BULK	TUBE WITHOUT CAP	CKT SIZE	VOID POSITION	PLATING TYPE	DIMENSION					TRAY	BULK	TUBE WITHOUT CAP	CKT SIZE	VOID POSITION	PLATING TYPE	DIMENSION					
						A	B	F	M	P							A	B	F	M	P	
F	-----	87891-3701	-----	37	-----	1	93.98	91.44	11.30	5.84	2.97	-----	87891-4001	-----	40	-----	1	101.60	99.06	11.30	5.84	2.97
	-----	87891-3702	-----	37	-----	2	93.98	91.44	11.30	5.84	2.97	-----	87891-4002	-----	40	-----	2	101.60	99.06	11.30	5.84	2.97
	-----	87891-3703	-----	37	-----	3	93.98	91.44	11.30	5.84	2.97	-----	87891-4003	-----	40	-----	3	101.60	99.06	11.30	5.84	2.97
	-----	87891-3704	-----	37	-----	4	93.98	91.44	11.30	5.84	2.97	-----	87891-4004	-----	40	-----	4	101.60	99.06	11.30	5.84	2.97
	-----	87891-3705	-----	37	-----	5	93.98	91.44	11.30	5.84	2.97	-----	87891-4005	-----	40	-----	5	101.60	99.06	11.30	5.84	2.97
	-----	87891-3706	-----	37	-----	6	93.98	91.44	11.30	5.84	2.97	-----	87891-4006	-----	40	-----	6	101.60	99.06	11.30	5.84	2.97
E																						
	-----	87891-3801	-----	38	-----	1	96.52	93.98	11.30	5.84	2.97											
	-----	87891-3802	-----	38	-----	2	96.52	93.98	11.30	5.84	2.97											
	-----	87891-3803	-----	38	-----	3	96.52	93.98	11.30	5.84	2.97											
	-----	87891-3804	-----	38	-----	4	96.52	93.98	11.30	5.84	2.97											
D	-----	87891-3805	-----	38	-----	5	96.52	93.98	11.30	5.84	2.97											
	-----	87891-3806	-----	38	-----	6	96.52	93.98	11.30	5.84	2.97											
	-----	87891-3901	-----	39	-----	1	99.06	96.52	11.30	5.84	2.97											
	-----	87891-3902	-----	39	-----	2	99.06	96.52	11.30	5.84	2.97											
C	-----	87891-3903	-----	39	-----	3	99.06	96.52	11.30	5.84	2.97											
	-----	87891-3904	-----	39	-----	4	99.06	96.52	11.30	5.84	2.97											
	-----	87891-3905	-----	39	-----	5	99.06	96.52	11.30	5.84	2.97											
	-----	87891-3906	-----	39	-----	6	99.06	96.52	11.30	5.84	2.97											
B																						

QUALITY SYMBOLS =0 =0	GENERAL TOLERANCES (UNLESS SPECIFIED) <table border="1"> <tr><th colspan="2">mm</th><th colspan="2">INCH</th></tr> <tr><td>4 PLACES</td><td>± ---</td><td>± ---</td><td>± ---</td></tr> <tr><td>3 PLACES</td><td>± ---</td><td>± ---</td><td>± ---</td></tr> <tr><td>2 PLACES</td><td>± 0.20</td><td>± ---</td><td>± ---</td></tr> <tr><td>1 PLACE</td><td>± ---</td><td>± ---</td><td>± ---</td></tr> </table>	mm		INCH		4 PLACES	± ---	± ---	± ---	3 PLACES	± ---	± ---	± ---	2 PLACES	± 0.20	± ---	± ---	1 PLACE	± ---	± ---	± ---	DIMENSION STYLE MM ONLY	SCALE NTS	DESIGN UNITS METRIC	THIRD ANGLE PROJECTION	DESCRIPTION CUSTOM HEADER 2.54MM PITCH, SINGLE ROW SINGLE WAFER, T/H HEADER	DATE 2004/11/17	DATE 2004/12/01	DATE 2004/12/06	MOLEX INCORPORATED	SHEET NO. 8 OF 8
		mm		INCH																											
		4 PLACES	± ---	± ---	± ---																										
		3 PLACES	± ---	± ---	± ---																										
2 PLACES	± 0.20	± ---	± ---																												
1 PLACE	± ---	± ---	± ---																												
DRAWN BY YLQ1A0	CHECKED BY PTL IM	APPROVED BY SCLOW	DOCUMENT NO. SD-87891-013																												
DRAFT WHERE APPLICABLE MUST REMAIN WITHIN DIMENSIONS			SEE TABLE	SIZE A3	THIS DRAWING CONTAINS INFORMATION THAT IS PROPRIETARY TO MOLEX INCORPORATED AND SHOULD NOT BE USED WITHOUT WRITTEN PERMISSION																										
EWB# 1023 EC NO: S2007-0289 DRWNS:KLI M01 CHKD:CWAM APPR:KWLEE	2006/09/29 2006/09/29 2006/09/30	REV B	DESCRIPTION REV																												

10 9 8 7 6 5 4 3 2 1

F

F

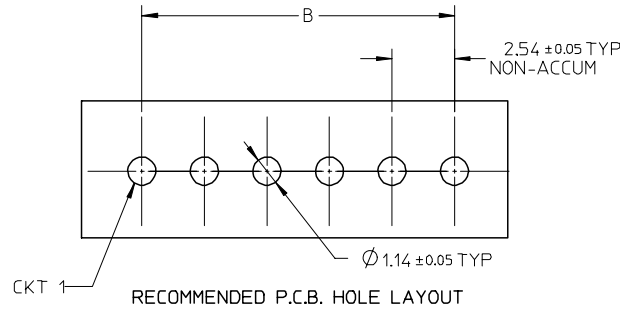
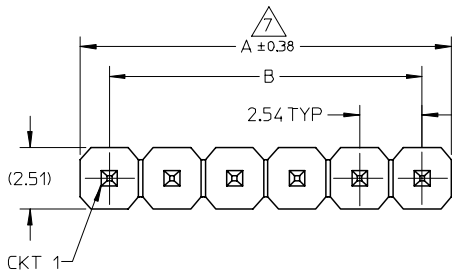

NOTES

1. MATERIAL:
 - HSG: NYLON, GLASS-FILLED, UL94V-0 COLOR: BLACK
 - PIN: 0.64MM SQ, COPPER ALLOY
2. PLATING TYPE:
 - (1) GOLD FLASH OVER
1.270µm MIN. NICKEL OVERALL.
 - (2) GOLD FLASH ON CONTACT AND
1.905µm MIN. TIN ON SOLDER TAIL OVER
1.270µm MIN. NICKEL OVERALL.
 - (3) 0.254µm MIN. GOLD PLATE ON CONTACT AND
1.905µm MIN. TIN ON SOLDER TAIL OVER
1.270µm MIN. NICKEL OVERALL.
 - (4) 0.381µm MIN. GOLD PLATE ON CONTACT AND
1.905µm MIN. TIN ON SOLDER TAIL OVER
1.270µm MIN. NICKEL OVERALL.
 - (5) 0.762µm MIN. GOLD PLATE ON CONTACT AND
1.905µm MIN. TIN ON SOLDER TAIL OVER
1.270µm MIN. NICKEL OVERALL.
 - (6) 2.540µm/100µm MIN TIN OVERALL
1.270µm/50µm NICKEL OVERALL
3. PRODUCT SPECIFICATION: PS-87920-019
4. PACKAGING TYPE: SEE TABLE
5. WAFER TO BE FLAT WITHIN 0.003 mm/mm
6. RECOMMENDED PCB THICKNESS IS 1.60mm±0.10
- △ IRREGULAR CIRCUIT CUTOFF WITHIN BREAKAWAY SECTION IS PERMISSIBLE. CUTTING OR CHIPPING OF THE MAIN BODY IS NOT ACCEPTABLE
8. THE ABOVE CKT 6 IS FOR ILLUSTRATION PURPOSE ONLY
9. PACKAGING SPECIFICATION:
 - TRAY: PK-89990-489
 - BULK: PK-89990-491

E

E

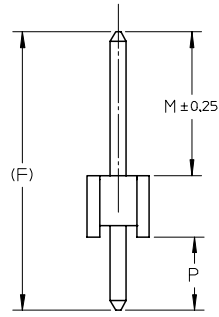
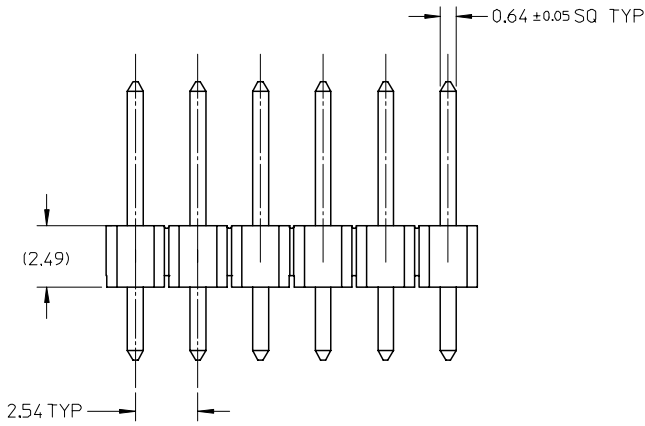

D

D

C

C

B

B

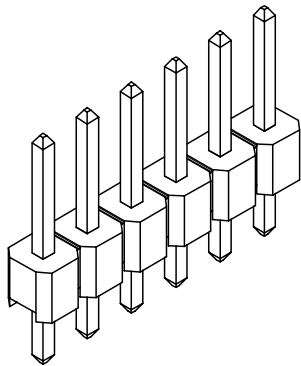

A

A

EWR# 1023 EC NO: S2007-0289 DRWN:SKL/M01 CHKD:C/LAM APPR:K/LEE 2006/09/29 2006/09/29 2006/09/30	QUALITY SYMBOLS ▽=0 ▽C=0	GENERAL TOLERANCES (UNLESS SPECIFIED) <table border="1"> <thead> <tr> <th></th> <th>mm</th> <th>INCH</th> </tr> </thead> <tbody> <tr> <td>4 PLACES</td> <td>± ---</td> <td>± ---</td> </tr> <tr> <td>3 PLACES</td> <td>± ---</td> <td>± ---</td> </tr> <tr> <td>2 PLACES</td> <td>± 0.20</td> <td>± ---</td> </tr> <tr> <td>1 PLACE</td> <td>± ---</td> <td>± ---</td> </tr> <tr> <td colspan="3">ANGULAR ± 3 °</td> </tr> </tbody> </table>		mm	INCH	4 PLACES	± ---	± ---	3 PLACES	± ---	± ---	2 PLACES	± 0.20	± ---	1 PLACE	± ---	± ---	ANGULAR ± 3 °			DIMENSION STYLE MM ONLY	SCALE NTS	DESIGN UNITS METRIC	THIRD ANGLE PROJECTION
		mm	INCH																					
	4 PLACES	± ---	± ---																					
	3 PLACES	± ---	± ---																					
2 PLACES	± 0.20	± ---																						
1 PLACE	± ---	± ---																						
ANGULAR ± 3 °																								
DRAWN BY YLQ1A0	DATE 2004/11/17	TITLE CUSTOM HEADER 2.54MM PITCH, SINGLE ROW SINGLE WAFER, T/H HEADER																						
CHECKED BY PTL IM	DATE 2004/12/01	MOLEX INCORPORATED																						
APPROVED BY SCLOW	DATE 2004/12/06	MATERIAL NO. SEE TABLE	DOCUMENT NO. SD-87891-013	SHEET NO. 1 OF 8																				

9 8 7 6 5 4 3 2 1

PACKAGING OPTION PART NO.										PACKAGING OPTION PART NO.											
TRAY	BULK	TUBE WITHOUT CAP	CKT SIZE	VOID POSITION	PLATING TYPE	DIMENSION					TRAY	BULK	TUBE WITHOUT CAP	CKT SIZE	VOID POSITION	PLATING TYPE	DIMENSION				
						A	B	F	M	P							A	B	F	M	P
87891-0101	-----	-----	1	-----	1	2.54	----	11.30	5.84	2.97	87891-0401	-----	-----	4	-----	1	10.16	7.62	11.30	5.84	2.97
87891-0102	-----	-----	1	-----	2	2.54	----	11.30	5.84	2.97	87891-0412	-----	-----	4	-----	2	10.16	7.62	11.30	5.84	2.97
87891-0103	-----	-----	1	-----	3	2.54	----	11.30	5.84	2.97	87891-0403	-----	-----	4	-----	3	10.16	7.62	11.30	5.84	2.97
87891-0104	-----	-----	1	-----	4	2.54	----	11.30	5.84	2.97	87891-0404	-----	-----	4	-----	4	10.16	7.62	11.30	5.84	2.97
87891-0105	-----	-----	1	-----	5	2.54	----	11.30	5.84	2.97	87891-0405	-----	-----	4	-----	5	10.16	7.62	11.30	5.84	2.97
87891-0106	-----	-----	1	-----	6	2.54	----	11.30	5.84	2.97	87891-0406	-----	-----	4	-----	6	10.16	7.62	11.30	5.84	2.97
87891-0201	-----	-----	2	-----	1	5.08	2.54	11.30	5.84	2.97	87891-0511	-----	-----	5	-----	1	12.70	10.16	11.30	5.84	2.97
87891-0202	-----	-----	2	-----	2	5.08	2.54	11.30	5.84	2.97	87891-0512	-----	-----	5	-----	2	12.70	10.16	11.30	5.84	2.97
87891-0203	-----	-----	2	-----	3	5.08	2.54	11.30	5.84	2.97	87891-0513	-----	-----	5	-----	3	12.70	10.16	11.30	5.84	2.97
87891-0204	-----	-----	2	-----	4	5.08	2.54	11.30	5.84	2.97	87891-0514	-----	-----	5	-----	4	12.70	10.16	11.30	5.84	2.97
87891-0205	-----	-----	2	-----	5	5.08	2.54	11.30	5.84	2.97	87891-0515	-----	-----	5	-----	5	12.70	10.16	11.30	5.84	2.97
87891-0206	-----	-----	2	-----	6	5.08	2.54	11.30	5.84	2.97	87891-0506	-----	-----	5	-----	6	12.70	10.16	11.30	5.84	2.97
87891-0301	-----	-----	3	-----	1	7.62	5.08	11.30	5.84	2.97	87891-0601	-----	-----	6	-----	1	15.24	12.70	11.30	5.84	2.97
87891-0302	-----	-----	3	-----	2	7.62	5.08	11.30	5.84	2.97	87891-0612	-----	-----	6	-----	2	15.24	12.70	11.30	5.84	2.97
87891-0303	-----	-----	3	-----	3	7.62	5.08	11.30	5.84	2.97	87891-0603	-----	-----	6	-----	3	15.24	12.70	11.30	5.84	2.97
87891-0304	-----	-----	3	-----	4	7.62	5.08	11.30	5.84	2.97	87891-0604	-----	-----	6	-----	4	15.24	12.70	11.30	5.84	2.97
87891-0305	-----	-----	3	-----	5	7.62	5.08	11.30	5.84	2.97	87891-0605	-----	-----	6	-----	5	15.24	12.70	11.30	5.84	2.97
87891-0306	-----	-----	3	-----	6	7.62	5.08	11.30	5.84	2.97	87891-0606	-----	-----	6	-----	6	15.24	12.70	11.30	5.84	2.97

EWR# 1023 EC NO: S2007-0289 DRWNS:KLI M01 2006/09/29 CHKD:CWJAM 2006/09/29 APPR:KWLEE 2006/09/30	QUALITY SYMBOLS =0 =0	GENERAL TOLERANCES (UNLESS SPECIFIED)		DIMENSION STYLE MM ONLY		SCALE NTS	DESIGN UNITS METRIC	THIRD ANGLE PROJECTION			
		4 PLACES ± --- ± --- 3 PLACES ± --- ± --- 2 PLACES ± 0.20 ± --- 1 PLACE ± --- ± ---	mm INCH	DRAWN BY YLQ1A0	DATE 2004/11/17	TITLE CUSTOM HEADER 2.54MM PITCH, SINGLE ROW SINGLE WAFER, T/H HEADER					
		ANGULAR ± 3 °		CHECKED BY PTL IM	DATE 2004/12/01	MOLEX INCORPORATED					
		DRAFT WHERE APPLICABLE MUST REMAIN WITHIN DIMENSIONS		APPROVED BY SCLOW	DATE 2004/12/06	MATERIAL NO. SEE TABLE	DOCUMENT NO. SD-87891-013	SHEET NO. 2 OF 8			

PACKAGING OPTION PART NO.		CKT SIZE	VOID POSITION	PLATING TYPE	DIMENSION					PACKAGING OPTION PART NO.		CKT SIZE	VOID POSITION	PLATING TYPE	DIMENSION							
TRAY	BULK				TUBE WITHOUT CAP	A	B	F	M	P	TRAY				BULK	TUBE WITHOUT CAP	A	B	F	M	P	
F	87891-0711	-----	-----	7	-----	1	17.78	15.24	11.30	5.84	2.97	87891-1001	-----	-----	10	-----	1	25.40	22.86	11.30	5.84	2.97
	87891-0702	-----	-----	7	-----	2	17.78	15.24	11.30	5.84	2.97	87891-1002	-----	-----	10	-----	2	25.40	22.86	11.30	5.84	2.97
	87891-0703	-----	-----	7	-----	3	17.78	15.24	11.30	5.84	2.97	87891-1003	-----	-----	10	-----	3	25.40	22.86	11.30	5.84	2.97
	87891-0704	-----	-----	7	-----	4	17.78	15.24	11.30	5.84	2.97	87891-1004	-----	-----	10	-----	4	25.40	22.86	11.30	5.84	2.97
	87891-0705	-----	-----	7	-----	5	17.78	15.24	11.30	5.84	2.97	87891-1005	-----	-----	10	-----	5	25.40	22.86	11.30	5.84	2.97
	87891-0706	-----	-----	7	-----	6	17.78	15.24	11.30	5.84	2.97	87891-1006	-----	-----	10	-----	6	25.40	22.86	11.30	5.84	2.97
E																						
	87891-0801	-----	-----	8	-----	1	20.32	17.78	11.30	5.84	2.97	87891-1101	-----	-----	11	-----	1	27.94	25.40	11.30	5.84	2.97
	87891-0802	-----	-----	8	-----	2	20.32	17.78	11.30	5.84	2.97	87891-1102	-----	-----	11	-----	2	27.94	25.40	11.30	5.84	2.97
	87891-0803	-----	-----	8	-----	3	20.32	17.78	11.30	5.84	2.97	87891-1103	-----	-----	11	-----	3	27.94	25.40	11.30	5.84	2.97
	87891-0804	-----	-----	8	-----	4	20.32	17.78	11.30	5.84	2.97	87891-1104	-----	-----	11	-----	4	27.94	25.40	11.30	5.84	2.97
D	87891-0805	-----	-----	8	-----	5	20.32	17.78	11.30	5.84	2.97	87891-1105	-----	-----	11	-----	5	27.94	25.40	11.30	5.84	2.97
	87891-0806	-----	-----	8	-----	6	20.32	17.78	11.30	5.84	2.97	87891-1106	-----	-----	11	-----	6	27.94	25.40	11.30	5.84	2.97
	87891-0901	-----	-----	9	-----	1	22.86	20.32	11.30	5.84	2.97	87891-1201	-----	-----	12	-----	1	30.48	27.94	11.30	5.84	2.97
	87891-0902	-----	-----	9	-----	2	22.86	20.32	11.30	5.84	2.97	87891-1202	-----	-----	12	-----	2	30.48	27.94	11.30	5.84	2.97
C	87891-0903	-----	-----	9	-----	3	22.86	20.32	11.30	5.84	2.97	87891-1203	-----	-----	12	-----	3	30.48	27.94	11.30	5.84	2.97
	87891-0904	-----	-----	9	-----	4	22.86	20.32	11.30	5.84	2.97	87891-1204	-----	-----	12	-----	4	30.48	27.94	11.30	5.84	2.97
	87891-0905	-----	-----	9	-----	5	22.86	20.32	11.30	5.84	2.97	87891-1205	-----	-----	12	-----	5	30.48	27.94	11.30	5.84	2.97
	87891-0906	-----	-----	9	-----	6	22.86	20.32	11.30	5.84	2.97	87891-1206	-----	-----	12	-----	6	30.48	27.94	11.30	5.84	2.97
B																						

EWR# 1023 EC NO: S2007-0289 DRWNS:KLI M01 2006/09/29 CHKD:CWJAM 2006/09/29 APPR:KWLEE 2006/09/30	QUALITY SYMBOLS =0 =0	GENERAL TOLERANCES (UNLESS SPECIFIED)		DIMENSION STYLE MM ONLY		SCALE NTS	DESIGN UNITS METRIC	THIRD ANGLE PROJECTION			
		4 PLACES ± --- ± --- 3 PLACES ± --- ± --- 2 PLACES ± 0.20 ± --- 1 PLACE ± --- ± ---	mm INCH	DRAWN BY YLQ1A0	DATE 2004/11/17	TITLE CUSTOM HEADER 2.54MM PITCH, SINGLE ROW SINGLE WAFER, T/H HEADER					
		ANGULAR ± 3 °		CHECKED BY PTL IM	DATE 2004/12/01						
		DRAFT WHERE APPLICABLE MUST REMAIN WITHIN DIMENSIONS		APPROVED BY SCLOW	DATE 2004/12/06	MATERIAL NO. SEE TABLE		DOCUMENT NO. SD-87891-013	SHEET NO. 3 OF 8		

PACKAGING OPTION PART NO.		CKT SIZE	VOID POSITION	PLATING TYPE	DIMENSION					PACKAGING OPTION PART NO.		CKT SIZE	VOID POSITION	PLATING TYPE	DIMENSION								
TRAY	BULK				TUBE WITHOUT CAP	A	B	F	M	P	TRAY				BULK	TUBE WITHOUT CAP	A	B	F	M	P		
F	87891-1301	-----	-----	13	-----	1	33.02	30.48	11.30	5.84	2.97	87891-1601	-----	-----	16	-----	1	40.64	38.10	11.30	5.84	2.97	F
	87891-1302	-----	-----	13	-----	2	33.02	30.48	11.30	5.84	2.97	87891-1602	-----	-----	16	-----	2	40.64	38.10	11.30	5.84	2.97	
	87891-1303	-----	-----	13	-----	3	33.02	30.48	11.30	5.84	2.97	87891-1603	-----	-----	16	-----	3	40.64	38.10	11.30	5.84	2.97	
	87891-1304	-----	-----	13	-----	4	33.02	30.48	11.30	5.84	2.97	87891-1604	-----	-----	16	-----	4	40.64	38.10	11.30	5.84	2.97	
	87891-1305	-----	-----	13	-----	5	33.02	30.48	11.30	5.84	2.97	87891-1605	-----	-----	16	-----	5	40.64	38.10	11.30	5.84	2.97	
	87891-1306	-----	-----	13	-----	6	33.02	30.48	11.30	5.84	2.97	87891-1606	-----	-----	16	-----	6	40.64	38.10	11.30	5.84	2.97	
E																							E
	87891-1401	-----	-----	14	-----	1	35.56	33.02	11.30	5.84	2.97	87891-1701	-----	-----	17	-----	1	43.18	40.64	11.30	5.84	2.97	
	87891-1402	-----	-----	14	-----	2	35.56	33.02	11.30	5.84	2.97	87891-1702	-----	-----	17	-----	2	43.18	40.64	11.30	5.84	2.97	
	87891-1403	-----	-----	14	-----	3	35.56	33.02	11.30	5.84	2.97	87891-1703	-----	-----	17	-----	3	43.18	40.64	11.30	5.84	2.97	
	87891-1404	-----	-----	14	-----	4	35.56	33.02	11.30	5.84	2.97	87891-1704	-----	-----	17	-----	4	43.18	40.64	11.30	5.84	2.97	
D	87891-1405	-----	-----	14	-----	5	35.56	33.02	11.30	5.84	2.97	87891-1705	-----	-----	17	-----	5	43.18	40.64	11.30	5.84	2.97	D
	87891-1406	-----	-----	14	-----	6	35.56	33.02	11.30	5.84	2.97	87891-1706	-----	-----	17	-----	6	43.18	40.64	11.30	5.84	2.97	
	87891-1501	-----	-----	15	-----	1	38.10	35.56	11.30	5.84	2.97	87891-1801	-----	-----	18	-----	1	45.72	43.18	11.30	5.84	2.97	
	87891-1502	-----	-----	15	-----	2	38.10	35.56	11.30	5.84	2.97	87891-1802	-----	-----	18	-----	2	45.72	43.18	11.30	5.84	2.97	
C	87891-1503	-----	-----	15	-----	3	38.10	35.56	11.30	5.84	2.97	87891-1803	-----	-----	18	-----	3	45.72	43.18	11.30	5.84	2.97	C
	87891-1504	-----	-----	15	-----	4	38.10	35.56	11.30	5.84	2.97	87891-1804	-----	-----	18	-----	4	45.72	43.18	11.30	5.84	2.97	
	87891-1505	-----	-----	15	-----	5	38.10	35.56	11.30	5.84	2.97	87891-1805	-----	-----	18	-----	5	45.72	43.18	11.30	5.84	2.97	
	87891-1506	-----	-----	15	-----	6	38.10	35.56	11.30	5.84	2.97	87891-1806	-----	-----	18	-----	6	45.72	43.18	11.30	5.84	2.97	
B																							B

EWR# 1023 EC NO: S2007-0289 DRWNS:KLI M01 2006/09/29 CHKD:CWJAM 2006/09/29 APPR:KWLEE 2006/09/30	QUALITY SYMBOLS =0 =0	GENERAL TOLERANCES (UNLESS SPECIFIED)		DIMENSION STYLE MM ONLY		SCALE NTS	DESIGN UNITS METRIC	THIRD ANGLE PROJECTION			
		4 PLACES ± --- ± --- 3 PLACES ± --- ± --- 2 PLACES ± 0.20 ± --- 1 PLACE ± --- ± ---	mm INCH	DRAWN BY YLQIAO	DATE 2004/11/17	TITLE CUSTOM HEADER 2.54MM PITCH, SINGLE ROW SINGLE WAFER, T/H HEADER					
		ANGULAR ± 3 °		CHECKED BY PTL IM	DATE 2004/12/01						
		DRAFT WHERE APPLICABLE MUST REMAIN WITHIN DIMENSIONS		APPROVED BY SCLOW	DATE 2004/12/06	MATERIAL NO. SEE TABLE		DOCUMENT NO. SD-87891-013	SHEET NO. 4 OF 8		



PACKAGING OPTION PART NO.		CKT SIZE	VOID POSITION	PLATING TYPE	DIMENSION					PACKAGING OPTION PART NO.		CKT SIZE	VOID POSITION	PLATING TYPE	DIMENSION								
TRAY	BULK				TUBE WITHOUT CAP	A	B	F	M	P	TRAY				BULK	TUBE WITHOUT CAP	A	B	F	M	P		
F	87891-1901	-----	-----	19	----	1	48.26	45.72	11.30	5.84	2.97	87891-2201	-----	-----	22	----	1	55.88	53.34	11.30	5.84	2.97	F
	87891-1902	-----	-----	19	----	2	48.26	45.72	11.30	5.84	2.97	87891-2202	-----	-----	22	----	2	55.88	53.34	11.30	5.84	2.97	
	87891-1903	-----	-----	19	----	3	48.26	45.72	11.30	5.84	2.97	87891-2203	-----	-----	22	----	3	55.88	53.34	11.30	5.84	2.97	
	87891-1904	-----	-----	19	----	4	48.26	45.72	11.30	5.84	2.97	87891-2204	-----	-----	22	----	4	55.88	53.34	11.30	5.84	2.97	
	87891-1905	-----	-----	19	----	5	48.26	45.72	11.30	5.84	2.97	87891-2205	-----	-----	22	----	5	55.88	53.34	11.30	5.84	2.97	
	87891-1906	-----	-----	19	----	6	48.26	45.72	11.30	5.84	2.97	87891-2206	-----	-----	22	----	6	55.88	53.34	11.30	5.84	2.97	
E																							E
	87891-2001	-----	-----	20	----	1	50.80	48.26	11.30	5.84	2.97	87891-2301	-----	-----	23	----	1	58.42	55.88	11.30	5.84	2.97	
	87891-2002	-----	-----	20	----	2	50.80	48.26	11.30	5.84	2.97	87891-2302	-----	-----	23	----	2	58.42	55.88	11.30	5.84	2.97	
	87891-2003	-----	-----	20	----	3	50.80	48.26	11.30	5.84	2.97	87891-2303	-----	-----	23	----	3	58.42	55.88	11.30	5.84	2.97	
	87891-2004	-----	-----	20	----	4	50.80	48.26	11.30	5.84	2.97	87891-2304	-----	-----	23	----	4	58.42	55.88	11.30	5.84	2.97	
D	87891-2005	-----	-----	20	----	5	50.80	48.26	11.30	5.84	2.97	87891-2305	-----	-----	23	----	5	58.42	55.88	11.30	5.84	2.97	D
	87891-2006	-----	-----	20	----	6	50.80	48.26	11.30	5.84	2.97	87891-2306	-----	-----	23	----	6	58.42	55.88	11.30	5.84	2.97	
	87891-2101	-----	-----	21	----	1	53.34	50.80	11.30	5.84	2.97	87891-2401	-----	-----	24	----	1	60.96	58.42	11.30	5.84	2.97	
	87891-2102	-----	-----	21	----	2	53.34	50.80	11.30	5.84	2.97	87891-2402	-----	-----	24	----	2	60.96	58.42	11.30	5.84	2.97	
C	87891-2103	-----	-----	21	----	3	53.34	50.80	11.30	5.84	2.97	87891-2403	-----	-----	24	----	3	60.96	58.42	11.30	5.84	2.97	C
	87891-2104	-----	-----	21	----	4	53.34	50.80	11.30	5.84	2.97	87891-2404	-----	-----	24	----	4	60.96	58.42	11.30	5.84	2.97	
	87891-2105	-----	-----	21	----	5	53.34	50.80	11.30	5.84	2.97	87891-2405	-----	-----	24	----	5	60.96	58.42	11.30	5.84	2.97	
	87891-2106	-----	-----	21	----	6	53.34	50.80	11.30	5.84	2.97	87891-2406	-----	-----	24	----	6	60.96	58.42	11.30	5.84	2.97	
B																							B

EWB# 1023 EC NO: S2007-0289 DRWNS:SKLIM01 2006/09/29 CHKD:CWJAM 2006/09/29 APPR:KWLEE 2006/09/30	QUALITY SYMBOLS =0 =0	GENERAL TOLERANCES (UNLESS SPECIFIED)		DIMENSION STYLE MM ONLY		SCALE NTS	DESIGN UNITS METRIC	THIRD ANGLE PROJECTION			
		4 PLACES ± --- ± --- 3 PLACES ± --- ± --- 2 PLACES ± 0.20 ± --- 1 PLACE ± --- ± ---	mm INCH	DRAWN BY YLQ1A0	DATE 2004/11/17	TITLE CUSTOM HEADER 2.54MM PITCH, SINGLE ROW SINGLE WAFER, T/H HEADER					
		ANGULAR ± 3 °		CHECKED BY PTLIM	DATE 2004/12/01	MOLEX INCORPORATED					
		DRAFT WHERE APPLICABLE MUST REMAIN WITHIN DIMENSIONS		APPROVED BY SCLOW	DATE 2004/12/06	MATERIAL NO. SEE TABLE	DOCUMENT NO. SD-87891-013	SHEET NO. 5 OF 8			





PACKAGING OPTION PART NO.											PACKAGING OPTION PART NO.														
TRAY			BULK	TUBE WITHOUT CAP	CKT SIZE	VOID POSITION	PLATING TYPE	DIMENSION					TRAY			BULK	TUBE WITHOUT CAP	CKT SIZE	VOID POSITION	PLATING TYPE	DIMENSION				
A	B	F						M	P	A	B	F	M	P											
F	87891-2501	-----	-----	25	----	1	63.50	60.96	11.30	5.84	2.97	-----	87891-2801	-----	28	----	1	71.12	68.58	11.30	5.84	2.97	F		
	87891-2502	-----	-----	25	----	2	63.50	60.96	11.30	5.84	2.97	-----	87891-2802	-----	28	----	2	71.12	68.58	11.30	5.84	2.97			
	87891-2503	-----	-----	25	----	3	63.50	60.96	11.30	5.84	2.97	-----	87891-2803	-----	28	----	3	71.12	68.58	11.30	5.84	2.97			
	87891-2504	-----	-----	25	----	4	63.50	60.96	11.30	5.84	2.97	-----	87891-2804	-----	28	----	4	71.12	68.58	11.30	5.84	2.97			
	87891-2505	-----	-----	25	----	5	63.50	60.96	11.30	5.84	2.97	-----	87891-2805	-----	28	----	5	71.12	68.58	11.30	5.84	2.97			
	87891-2506	-----	-----	25	----	6	63.50	60.96	11.30	5.84	2.97	-----	87891-2806	-----	28	----	6	71.12	68.58	11.30	5.84	2.97			
E																							E		
	-----	87891-2611	-----	26	----	1	66.04	63.50	11.30	5.84	2.97	-----	87891-2901	-----	29	----	1	73.66	71.12	11.30	5.84	2.97			
	-----	87891-2602	-----	26	----	2	66.04	63.50	11.30	5.84	2.97	-----	87891-2902	-----	29	----	2	73.66	71.12	11.30	5.84	2.97			
	-----	87891-2603	-----	26	----	3	66.04	63.50	11.30	5.84	2.97	-----	87891-2903	-----	29	----	3	73.66	71.12	11.30	5.84	2.97			
	-----	87891-2604	-----	26	----	4	66.04	63.50	11.30	5.84	2.97	-----	87891-2904	-----	29	----	4	73.66	71.12	11.30	5.84	2.97			
D	-----	87891-2605	-----	26	----	5	66.04	63.50	11.30	5.84	2.97	-----	87891-2905	-----	29	----	5	73.66	71.12	11.30	5.84	2.97	D		
	-----	87891-2606	-----	26	----	6	66.04	63.50	11.30	5.84	2.97	-----	87891-2906	-----	29	----	6	73.66	71.12	11.30	5.84	2.97			
	-----	87891-2701	-----	27	----	1	68.58	66.04	11.30	5.84	2.97	-----	87891-3001	-----	30	----	1	76.20	73.66	11.30	5.84	2.97			
	-----	87891-2702	-----	27	----	2	68.58	66.04	11.30	5.84	2.97	-----	87891-3002	-----	30	----	2	76.20	73.66	11.30	5.84	2.97			
C	-----	87891-2703	-----	27	----	3	68.58	66.04	11.30	5.84	2.97	-----	87891-3003	-----	30	----	3	76.20	73.66	11.30	5.84	2.97	C		
	-----	87891-2704	-----	27	----	4	68.58	66.04	11.30	5.84	2.97	-----	87891-3004	-----	30	----	4	76.20	73.66	11.30	5.84	2.97			
	-----	87891-2705	-----	27	----	5	68.58	66.04	11.30	5.84	2.97	-----	87891-3005	-----	30	----	5	76.20	73.66	11.30	5.84	2.97			
	-----	87891-2706	-----	27	----	6	68.58	66.04	11.30	5.84	2.97	-----	87891-3006	-----	30	----	6	76.20	73.66	11.30	5.84	2.97			
B																							B		

EWR# 1023 EC NO: S2007-0289 DRWNS:KLI M01 2006/09/29 CHKD:CWJAM 2006/09/29 APPR:KWLEE 2006/09/30	QUALITY SYMBOLS =0 =0	GENERAL TOLERANCES (UNLESS SPECIFIED)		DIMENSION STYLE MM ONLY		SCALE NTS	DESIGN UNITS METRIC	THIRD ANGLE PROJECTION			
		4 PLACES ± --- ± --- 3 PLACES ± --- ± --- 2 PLACES ± 0.20 ± --- 1 PLACE ± --- ± ---	mm INCH	DRAWN BY YLQ1A0	DATE 2004/11/17	TITLE CUSTOM HEADER 2.54MM PITCH, SINGLE ROW SINGLE WAFER, T/H HEADER		MOLEX INCORPORATED			
		ANGULAR ± 3 °		CHECKED BY PTL IM	DATE 2004/12/01	APPROVED BY SCLOW					
		DRAFT WHERE APPLICABLE MUST REMAIN WITHIN DIMENSIONS		SEE TABLE		MATERIAL NO.		DOCUMENT NO. SD-87891-013		SHEET NO. 6 OF 8	

PACKAGING OPTION PART NO.		CKT SIZE	VOID POSITION	PLATING TYPE	DIMENSION					PACKAGING OPTION PART NO.		CKT SIZE	VOID POSITION	PLATING TYPE	DIMENSION							
TRAY	BULK				TUBE WITHOUT CAP	A	B	F	M	P	TRAY				BULK	TUBE WITHOUT CAP	A	B	F	M	P	
F	-----	87891-3101	-----	31	-----	1	78.74	76.20	11.30	5.84	2.97	-----	87891-3401	-----	34	-----	1	86.36	83.82	11.30	5.84	2.97
	-----	87891-3102	-----	31	-----	2	78.74	76.20	11.30	5.84	2.97	-----	87891-3402	-----	34	-----	2	86.36	83.82	11.30	5.84	2.97
	-----	87891-3103	-----	31	-----	3	78.74	76.20	11.30	5.84	2.97	-----	87891-3403	-----	34	-----	3	86.36	83.82	11.30	5.84	2.97
	-----	87891-3104	-----	31	-----	4	78.74	76.20	11.30	5.84	2.97	-----	87891-3404	-----	34	-----	4	86.36	83.82	11.30	5.84	2.97
	-----	87891-3105	-----	31	-----	5	78.74	76.20	11.30	5.84	2.97	-----	87891-3405	-----	34	-----	5	86.36	83.82	11.30	5.84	2.97
	-----	87891-3106	-----	31	-----	6	78.74	76.20	11.30	5.84	2.97	-----	87891-3406	-----	34	-----	6	86.36	83.82	11.30	5.84	2.97
E																						
	-----	87891-3201	-----	32	-----	1	81.28	78.74	11.30	5.84	2.97	-----	87891-3501	-----	35	-----	1	88.90	86.36	11.30	5.84	2.97
	-----	87891-3202	-----	32	-----	2	81.28	78.74	11.30	5.84	2.97	-----	87891-3502	-----	35	-----	2	88.90	86.36	11.30	5.84	2.97
	-----	87891-3203	-----	32	-----	3	81.28	78.74	11.30	5.84	2.97	-----	87891-3503	-----	35	-----	3	88.90	86.36	11.30	5.84	2.97
	-----	87891-3204	-----	32	-----	4	81.28	78.74	11.30	5.84	2.97	-----	87891-3504	-----	35	-----	4	88.90	86.36	11.30	5.84	2.97
D	-----	87891-3205	-----	32	-----	5	81.28	78.74	11.30	5.84	2.97	-----	87891-3505	-----	35	-----	5	88.90	86.36	11.30	5.84	2.97
	-----	87891-3206	-----	32	-----	6	81.28	78.74	11.30	5.84	2.97	-----	87891-3506	-----	35	-----	6	88.90	86.36	11.30	5.84	2.97
	-----	87891-3301	-----	33	-----	1	83.82	81.28	11.30	5.84	2.97	-----	87891-3611	-----	36	-----	1	91.44	88.90	11.30	5.84	2.97
	-----	87891-3302	-----	33	-----	2	83.82	81.28	11.30	5.84	2.97	-----	87891-3602	-----	36	-----	2	91.44	88.90	11.30	5.84	2.97
C	-----	87891-3303	-----	33	-----	3	83.82	81.28	11.30	5.84	2.97	-----	87891-3603	-----	36	-----	3	91.44	88.90	11.30	5.84	2.97
	-----	87891-3304	-----	33	-----	4	83.82	81.28	11.30	5.84	2.97	-----	87891-3604	-----	36	-----	4	91.44	88.90	11.30	5.84	2.97
	-----	87891-3305	-----	33	-----	5	83.82	81.28	11.30	5.84	2.97	-----	87891-3605	-----	36	-----	5	91.44	88.90	11.30	5.84	2.97
	-----	87891-3306	-----	33	-----	6	83.82	81.28	11.30	5.84	2.97	-----	87891-3606	-----	36	-----	6	91.44	88.90	11.30	5.84	2.97
B																						

EWB# 1023 EC NO: S2007-0289 DRWNS:KLI M01 2006/09/29 CHKD:CWJAM 2006/09/29 APPR:KWLEE 2006/09/30	QUALITY SYMBOLS  = 0  = 0.20	GENERAL TOLERANCES (UNLESS SPECIFIED)		DIMENSION STYLE MM ONLY		SCALE NTS	DESIGN UNITS METRIC	 THIRD ANGLE PROJECTION			
		4 PLACES ± --- ± --- 3 PLACES ± --- ± --- 2 PLACES ± 0.20 ± --- 1 PLACE ± --- ± ---	mm INCH	DRAWN BY YLQ1A0	DATE 2004/11/17	TITLE CUSTOM HEADER 2.54MM PITCH, SINGLE ROW SINGLE WAFER, T/H HEADER					
		ANGULAR ± 3 °		APPROVED BY SCLOW	DATE 2004/12/06	MOLEX INCORPORATED					
		DRAFT WHERE APPLICABLE MUST REMAIN WITHIN DIMENSIONS		MATERIAL NO. SEE TABLE		DOCUMENT NO. SD-87891-013		SHEET NO. 7 OF 8			

PACKAGING OPTION PART NO.										PACKAGING OPTION PART NO.												
TRAY	BULK	TUBE WITHOUT CAP	CKT SIZE	VOID POSITION	PLATING TYPE	DIMENSION					TRAY	BULK	TUBE WITHOUT CAP	CKT SIZE	VOID POSITION	PLATING TYPE	DIMENSION					
						A	B	F	M	P							A	B	F	M	P	
F	-----	87891-3701	-----	37	-----	1	93.98	91.44	11.30	5.84	2.97	-----	87891-4001	-----	40	-----	1	101.60	99.06	11.30	5.84	2.97
	-----	87891-3702	-----	37	-----	2	93.98	91.44	11.30	5.84	2.97	-----	87891-4002	-----	40	-----	2	101.60	99.06	11.30	5.84	2.97
	-----	87891-3703	-----	37	-----	3	93.98	91.44	11.30	5.84	2.97	-----	87891-4003	-----	40	-----	3	101.60	99.06	11.30	5.84	2.97
	-----	87891-3704	-----	37	-----	4	93.98	91.44	11.30	5.84	2.97	-----	87891-4004	-----	40	-----	4	101.60	99.06	11.30	5.84	2.97
	-----	87891-3705	-----	37	-----	5	93.98	91.44	11.30	5.84	2.97	-----	87891-4005	-----	40	-----	5	101.60	99.06	11.30	5.84	2.97
	-----	87891-3706	-----	37	-----	6	93.98	91.44	11.30	5.84	2.97	-----	87891-4006	-----	40	-----	6	101.60	99.06	11.30	5.84	2.97
E																						
	-----	87891-3801	-----	38	-----	1	96.52	93.98	11.30	5.84	2.97											
	-----	87891-3802	-----	38	-----	2	96.52	93.98	11.30	5.84	2.97											
	-----	87891-3803	-----	38	-----	3	96.52	93.98	11.30	5.84	2.97											
	-----	87891-3804	-----	38	-----	4	96.52	93.98	11.30	5.84	2.97											
D	-----	87891-3805	-----	38	-----	5	96.52	93.98	11.30	5.84	2.97											
	-----	87891-3806	-----	38	-----	6	96.52	93.98	11.30	5.84	2.97											
	-----	87891-3901	-----	39	-----	1	99.06	96.52	11.30	5.84	2.97											
	-----	87891-3902	-----	39	-----	2	99.06	96.52	11.30	5.84	2.97											
C	-----	87891-3903	-----	39	-----	3	99.06	96.52	11.30	5.84	2.97											
	-----	87891-3904	-----	39	-----	4	99.06	96.52	11.30	5.84	2.97											
	-----	87891-3905	-----	39	-----	5	99.06	96.52	11.30	5.84	2.97											
	-----	87891-3906	-----	39	-----	6	99.06	96.52	11.30	5.84	2.97											
B																						

QUALITY SYMBOLS  = 0  = 0.25	GENERAL TOLERANCES (UNLESS SPECIFIED) <table border="1"> <tr><th colspan="2"></th><th>mm</th><th>INCH</th></tr> <tr><td>4 PLACES</td><td>±</td><td>---</td><td>±</td><td>---</td></tr> <tr><td>3 PLACES</td><td>±</td><td>---</td><td>±</td><td>---</td></tr> <tr><td>2 PLACES</td><td>±</td><td>0.20</td><td>±</td><td>---</td></tr> <tr><td>1 PLACE</td><td>±</td><td>---</td><td>±</td><td>---</td></tr> </table>			mm	INCH	4 PLACES	±	---	±	---	3 PLACES	±	---	±	---	2 PLACES	±	0.20	±	---	1 PLACE	±	---	±	---	DIMENSION STYLE MM ONLY	SCALE NTS	DESIGN UNITS METRIC	 THIRD ANGLE PROJECTION
			mm	INCH																									
	4 PLACES	±	---	±	---																								
	3 PLACES	±	---	±	---																								
2 PLACES	±	0.20	±	---																									
1 PLACE	±	---	±	---																									
DESCRIPTION EWR# 1023 EC NO: S2007-0289 DRWNS:KLI M01 CHKD:CWAM APPR:KWLEE	DATE 2006/09/29 2006/09/29 2006/09/30	DRAWN BY YLQ1A0	DATE 2004/11/17	TITLE CUSTOM HEADER 2.54MM PITCH, SINGLE ROW SINGLE WAFER, T/H HEADER	 MOLEX INCORPORATED																								
REV B	APPROVED BY SCLOW	DATE 2004/12/06	MATERIAL NO. SEE TABLE	DOCUMENT NO. SD-87891-013	SHEET NO. 8 OF 8																								
DRAFT WHERE APPLICABLE MUST REMAIN WITHIN DIMENSIONS	SIZE A3	THIS DRAWING CONTAINS INFORMATION THAT IS PROPRIETARY TO MOLEX INCORPORATED AND SHOULD NOT BE USED WITHOUT WRITTEN PERMISSION																											