

REVISIONS					
REV	ECO	DESCRIPTION	DATE	BY	APPR
A1	--	RELEASED	16MAR2020	J. HEAD	DH

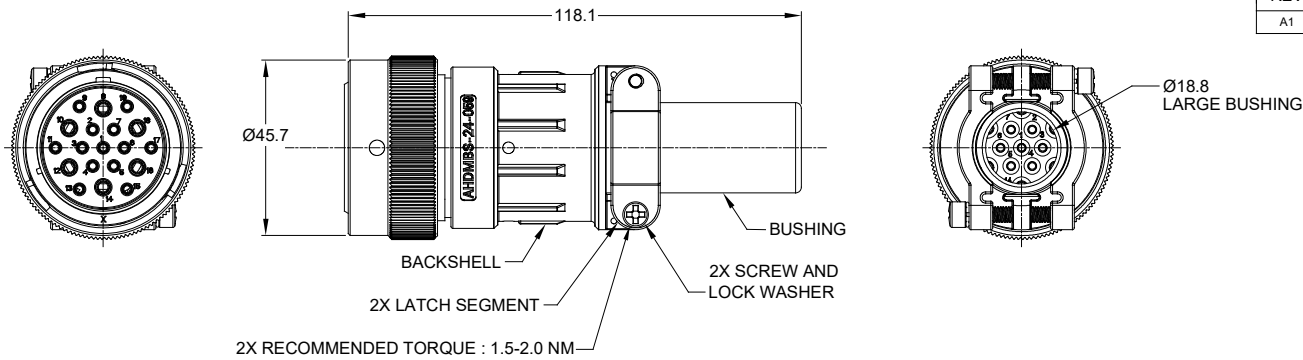

NOTES: UNLESS OTHERWISE SPECIFIED

1. PLUG MATERIAL:
SHELL: ZINC ALLOY, NICKEL PLATED
COUPLING RING: ALUMINUM ALLOY, NICKEL PLATED
INSERT AND RETAINING RING: THERMOPLASTIC
SEAL: SILICONE RUBBER
2. BACKSHELL MATERIAL:
SHELL: ALUMINIUM ALLOY, NICKEL PLATED;
LATCH SEGMENT: ALUMINIUM ALLOY, NICKEL PLATED;
SCREW AND LOCK WASHER: STAINLESS STEEL;
BUSHING: EPDM.
3. SPECIFICATIONS:
3.1 OPERATING TEMPERATURE: -55°C TO +125°C.
3.2 DIELECTRIC WITHSTANDING VOLTAGE: LESS THAN 2 MILLIAMPS CURRENT LEAKAGE @ 1500 VOLTS AC.
3.3 INSULATION RESISTANCE: 1000 MEGOHM MIN @ 25°C.
3.4 MOISTURE RESISTANCE: IP67 & IP69K (MATED CONDITION).
3.5 MATING CYCLE DURABILITY: 100 CYCLES
3.6 RoHS COMPLIANT
4. APPLY TO CABLE OD SIZE: Ø11.20-Ø24.08 . CAN BE USED:
4.1. WITH LARGE AND SMALL BUSHINGS IN PLACE.
4.2. WITH ONLY LARGE BUSHING IN PLACE.
4.3. WITH BOTH BUSHINGS REMOVED.
5. ALL DIMENSIONS ARE FOR REFERENCE USE ONLY.
6. SEE SPECIFIC PLUG DRAWING FOR:
6.1 CONTACT SIZE AND WIRE RANGE.
6.2 RETAINING RING COLOR.
6.3 MATING PART(S).
6.4 CONTACT LAYOUT AND ALL OTHER SPECIFICATIONS.

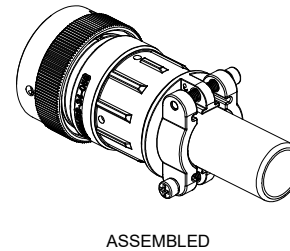

ASSEMBLED

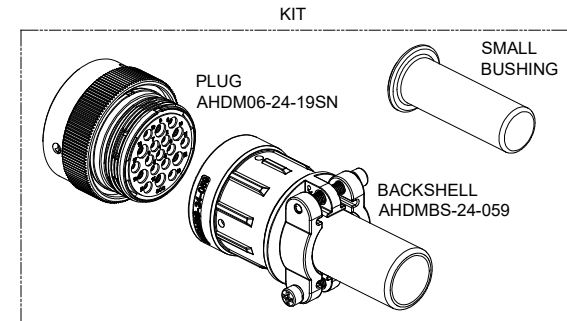

AHDM06-24-19SN-059		HDSB-24-19SN-059	
QUANTITY	PART NUMBER	DESCRIPTION	ITEM
MATERIALS LIST			
UNLESS OTHERWISE SPECIFIED: 1) All dimensions are in metric (mm). 2) Tolerances are as follows: 1 PL DEC ±0.30 Fractions ±1/64 2 PL DEC ±0.15 Angles ±1° 3 PL DEC ±0.08 3) Note reference =			
SIGNATURES		DATE	
DRAWN: J. HEAD		16MAR2020	
CHECKED:			
ENGINEER:			
APPROVAL:			
MATERIAL SPECIFICATIONS:		CUSTOMER:	
PROCESS SPECIFICATIONS:		THIS DRAWING IS SUPPLIED FOR INFORMATION ONLY. DESIGN FEATURES, SPECIFICATIONS AND PERFORMANCE DATA SHOWN HEREON ARE THE PROPERTY OF THE AMPHENOL CORPORATION. NO RIGHTS OF REPRODUCTION ARE IMPLIED. ALL DIMENSIONS ARE SUBJECT TO NORMAL MANUFACTURING VARIATIONS.	
NEXT ASSY:		SCALE: NONE	
		SHEET 1 OF 1	

Amphenol

Sine Systems - www.amphenol-sine.com
44724 Morley Drive
Clinton Township, MI 48036

DURAMATE AHDM PLUG, SIZE 24, WD THD, KIT W/ CABLE CLAMP BACKSHELL

SIZE: **B C-** DWG NO: **AHDM06-24-19SN-059** REVISION: **A1**

TITLE: KIT, PLUG AND BACKSHELL, SZ 24
DWG NO: AHDM06-24-19SN-059
REV: A1
SH: 1
OF: 1



AT Series™ - Contact Size 16 Options

Machined Contacts, Sockets & Pins				
Part Number	Description	Size	AWG	Type
AT60-215-1631	Male Contact - Pin, Gold-plated	16	14	Machined
AT62-209-1631	Female Contact - Socket, Gold-plated	16	14	Machined
AT60-215-16141	Male Contact - Pin, Nickel-plated	16	14	Machined
AT62-209-16141	Female Contact - Socket, Nickel-plated	16	14	Machined
AT60-202-1631	Male Contact - Pin, Gold-plated	16	16-20	Machined
AT62-201-1631	Female Contact - Socket, Gold-plated	16	16-20	Machined
AT60-202-16141	Male Contact - Pin, Nickel-plated	16	16-20	Machined
AT62-201-16141	Female Contact - Socket, Nickel-plated	16	16-20	Machined
AT60-202-1631-22	Male Contact - Pin, Gold-plated	16	22-24	Machined
AT62-201-1631-22	Female Contact - Socket, Gold-plated	16	22-24	Machined
AT60-202-16141-22	Male Contact - Pin, Nickel-plated	16	22-24	Machined
AT62-201-16141-22	Female Contact - Socket, Nickel-plated	16	22-24	Machined

Tooling - Machined Contacts		
Part	Part Number	Description
	CA-5D12	Universal Hand Crimp Tool, Size 12/16/20 (Machined contacts only)
	CA-5E12	Pneumatic Crimp Tool, Size 12/16/20 (Machined contacts only)

Contact Removal Tools		
Part	Part Number	Description
	ATRT-100	Used for removal of contacts for A Series™ products
	AT11-310-1605	Contact Removal Tool, Plastic, Size 16
	A114017	Sealing Plug, Size 16, White

Stamped & Formed Contacts, Sockets & Pins				
Part Number	Description	Size	AWG	Type
AT60-14-0144	Male Contact - Pin, Gold-plated	16	14-16	Stamped & Formed
AT62-14-0144	Female Contact - Socket, Gold-plated	16	14-16	Stamped & Formed
AT60-14-0122	Male Contact - Pin, Nickel-plated	16	14-16	Stamped & Formed
AT62-14-0122	Female Contact - Socket, Nickel-plated	16	14-16	Stamped & Formed
AT60-16-0144	Male Contact - Pin, Gold-plated	16	16-18	Stamped & Formed
AT62-16-0144	Female Contact - Socket, Gold-plated	16	16-18	Stamped & Formed
AT60-16-0122	Male Contact - Pin, Nickel-plated	16	16-18	Stamped & Formed
AT62-16-0122	Female Contact - Socket, Nickel-plated	16	16-18	Stamped & Formed
AT60-16-0644	Male Contact - Pin, Gold-plated	16	18-20	Stamped & Formed
AT62-16-0644	Female Contact - Socket, Gold-plated	16	18-20	Stamped & Formed
AT60-16-0622	Male Contact - Pin, Nickel-plated	16	18-20	Stamped & Formed
AT62-16-0622	Female Contact - Socket, Nickel-plated	16	18-20	Stamped & Formed
AT60-16-0844	Male Contact - Pin, Gold-plated	16	20-22	Stamped & Formed
AT62-16-0844	Female Contact - Socket, Gold-plated	16	20-22	Stamped & Formed
AT60-16-0822	Male Contact - Pin, Nickel-plated	16	20-22	Stamped & Formed
AT62-16-0822	Female Contact - Socket, Nickel-plated	16	20-22	Stamped & Formed

Tooling - Stamped & Formed Contacts		
Part	Part Number	Description
	MFX-3950	Crimp Die - Size 16, 18-20AWG (S&F contacts only)
	MFX-3953	Crimp Die - Size 16, 16-18AWG (S&F contacts only)
	MFX-3975	Crimp Die - Size 16, 14-16AWG (S&F contacts only)
	MFX-3990	Crimp Die - Size 16, 20-22AWG (S&F contacts only)
	ATT-16-00	Hand Crimp Tool - Size 16, 14-16AWG (S&F contacts only)
	ATT-16-01	Hand Crimp Tool - Size 16, 18-20AWG (S&F contacts only)
	ATT-1612-03	Hand Crimp Tool - Size 16, 20-22AWG (S&F contacts only)



Amphenol Sine Systems
 44724 Morley Drive
 Clinton Township, MI 48036 USA
www.amphenol-sine.com
 09/2021

ATP Series™ - Contact Size 12 Options



Machined Contacts, Sockets & Pins				
Part Number	Description	Size	AWG	Type
AT60-204-12141-10	Male Contact - Pin, Nickel-plated	12	10-12	Machined
AT62-203-12141-10	Female Contact - Socket, Nickel-plated	12	10-12	Machined
AT60-220-1231	Male Contact - Pin, Gold-plated	12	12-14	Machined
AT62-210-1231	Female Contact - Socket, Gold-plated	12	12-14	Machined
AT60-204-12141	Male Contact - Pin, Nickel-plated	12	12-14	Machined
AT62-203-12141	Female Contact - Socket, Nickel-plated	12	12-14	Machined

DiagnosticGrade™ Machined Contacts, Sockets & Pins				
• Smaller AWG for Diagnostic Applications • Gold-plated • Increased Mating Cycles • Cost-effective				
Part Number	Description	Size	AWG	Type
65-54749	Male Contact - DiagnosticGrade™, Pin, Gold-plated	12	20	Machined
AT62-210-1231-1820	Female Contact - DiagnosticGrade™, Socket, Gold-plated	12	20	Machined

Tooling - Machined Contacts		
Part	Part Number	Description
	CA-5D12	Universal Hand Crimp Tool, Size 12/16/20 (Machined contacts only)
	CA-5E12	Pneumatic Crimp Tool, Size 12/16/20 (Machined contacts only)

Contact Removal Tools		
Part	Part Number	Description
	ATRT-100	Used for removal of contacts for A Series™ products
	AT11-337-1205	Contact Removal Tool, Plastic, Size 12
	A114017	Sealing Plug, Size 12, White

Stamped & Formed Contacts, Sockets & Pins				
Part Number	Description	Size	AWG	Type
AT60-12-0244	Male Contact - Pin, Gold-plated	12	10-12	Stamped & Formed
AT62-12-0244	Female Contact - Socket, Gold-plated	12	10-12	Stamped & Formed
AT60-12-0222	Male Contact - Pin, Nickel-plated	12	10-12	Stamped & Formed
AT62-12-0222	Female Contact - Socket, Nickel-plated	12	10-12	Stamped & Formed
AT60-12-0144	Male Contact - Pin, Gold-plated	12	12-14	Stamped & Formed
AT62-12-0144	Female Contact - Socket, Gold-plated	12	12-14	Stamped & Formed
AT60-12-0166	Male Contact - Pin, Nickel-plated	12	12-14	Stamped & Formed
AT62-12-0166	Female Contact - Socket, Nickel-plated	12	12-14	Stamped & Formed

Tooling - Stamped & Formed Contacts		
Part	Part Number	Description
	MXF-3973	Crimp Die - Size 12 (S&F contacts only)
	MXF-3985	Crimp Die - Size 12 (S&F contacts only) 10-12AWG -02XX Series
	ATT-12-00	Hand Crimp Tool - Size 12, 12AWG (S&F contacts only)

Amphenol Sine Systems
 44724 Morley Drive
 Clinton Township, MI 48036 USA
www.amphenol-sine.com
 09/2021