



VIPer22A Single Output Reference Board  
90 to 264 VAC input, 10W output

---

## Introduction

This Application Note deals with an off-line wide range single output power supply using a VIPer22A off-line SMPS primary switcher manufactured by STMicroelectronics. The VIPer22A combines a dedicated current mode PWM controller with a high voltage Power MOSFET on the same silicon chip and its switching frequency is internally fixed at 60 kHz. The feedback path of the power supply includes an optocoupler for secondary regulation and galvanic isolation between primary and secondary sides. The output voltage is regulated at 12V with a maximum output current of 0.84A, resulting in a maximum output power of 10W.

## Product highlights

- Switch mode General Purpose Power Supply
- Single-sided Board
- 75% Typical Efficiency
- Output Short Circuit Protection
- Thermal Shutdown Protection
- Complies with EN55022 Class B EMI specifications
- Complies with Blue Angel standards

---

# Contents

<b>1</b>	<b>Summary description</b> .....	<b>3</b>
1.1	Board layout .....	4
<b>2</b>	<b>Test results</b> .....	<b>5</b>
2.1	Frequency ripple .....	5
2.2	Efficiency results .....	6
2.3	Load response .....	6
2.4	Line and load regulation .....	7
2.5	EMI emissions .....	8
<b>3</b>	<b>Waveforms</b> .....	<b>9</b>
<b>4</b>	<b>Output current and voltage capability</b> .....	<b>9</b>
<b>5</b>	<b>Thermal considerations</b> .....	<b>10</b>
<b>6</b>	<b>Blue angel standard</b> .....	<b>10</b>
<b>7</b>	<b>Transformer specifications</b> .....	<b>11</b>
<b>8</b>	<b>Component list</b> .....	<b>12</b>
<b>9</b>	<b>Revision history</b> .....	<b>14</b>

# 1 Summary description

*Table 1* lists the main parameters of the converter while a prototype of the board is shown in *Figure 1*.

**Table 1. Operating conditions**

Parameter	Limits
Input voltage range	90 to 264 V <sub>AC</sub>
Input frequency range	50/60 Hz
Output Voltage	V=12V
Output current	I=0.84A
Output power	10W
Efficiency	75% typical
Line regulation	± 0%
Load regulation	± 0.2%
Output voltage ripple	20m V <sub>PP</sub>
EMI	EN55022 class B

**Figure 1. Board prototype**

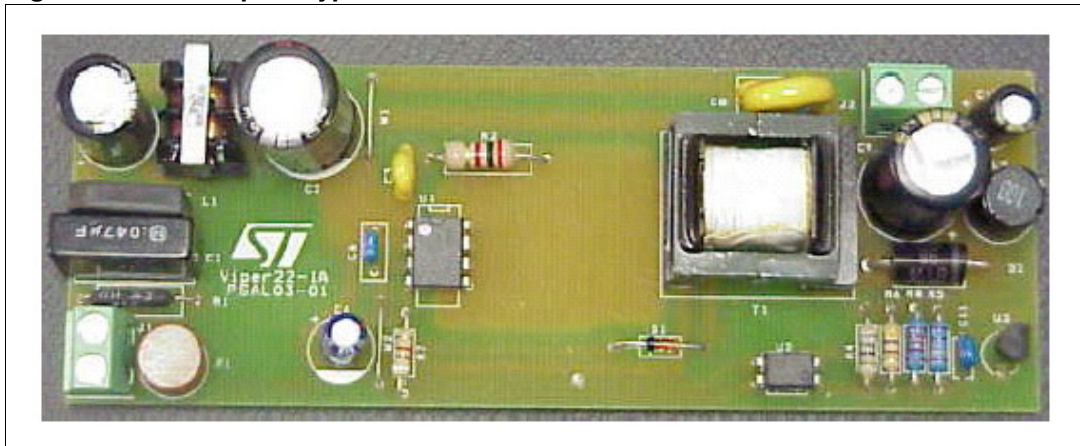

## 1.1 Board layout

Figure 2. Board top legend (not to scale)

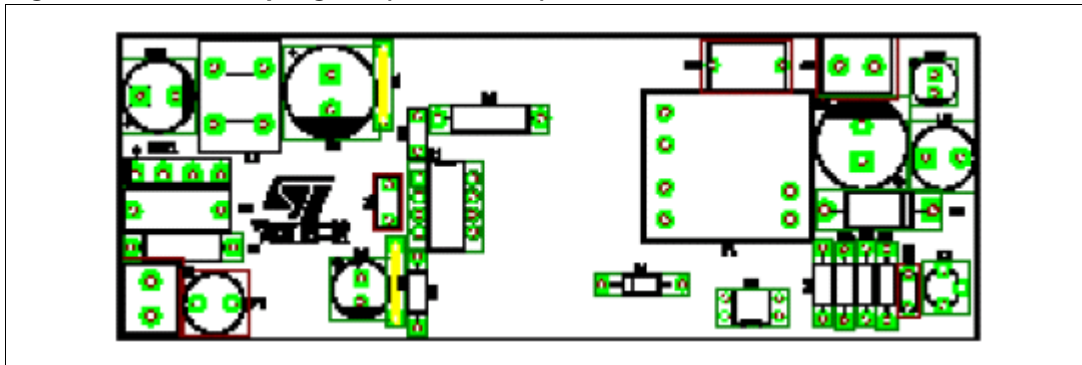
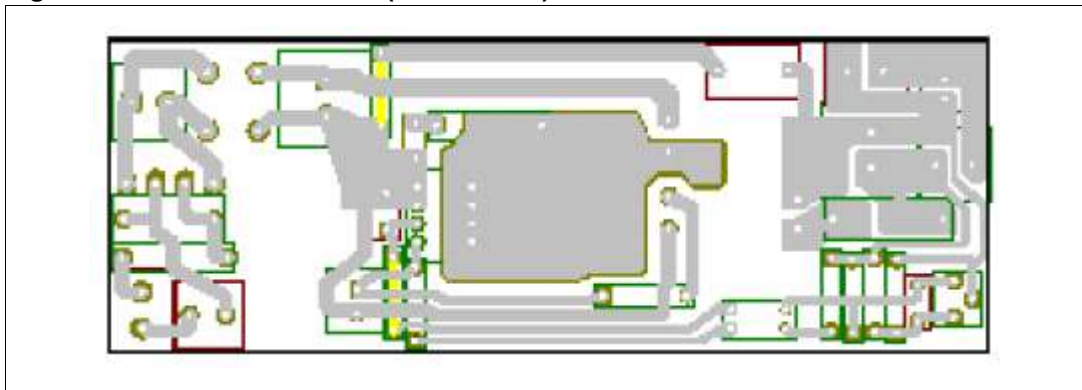

Figure 3. Board bottom foil (not to scale)



## 2 Test results

### 2.1 Frequency ripple

Figure 4 presents the line frequency ripple taken with an input voltage of 90 V<sub>AC</sub>. A 10mV<sub>PP</sub> amplitude is measured at the output. Figure 5 shows the switching ripple on the output at the full load of 0.84A.

Figure 4. Line frequency ripple

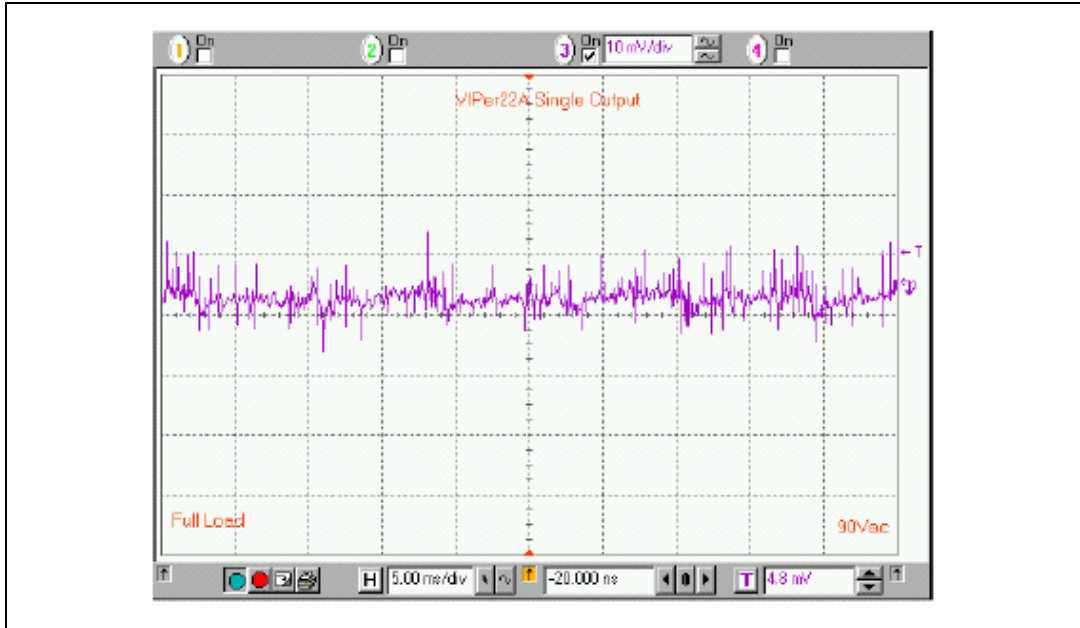
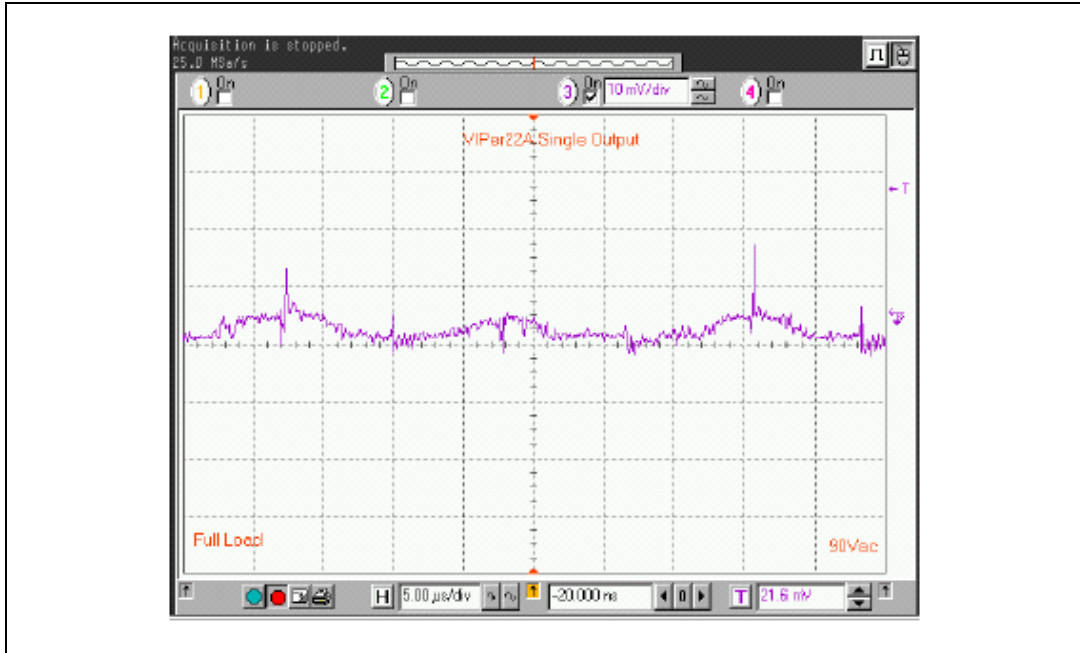
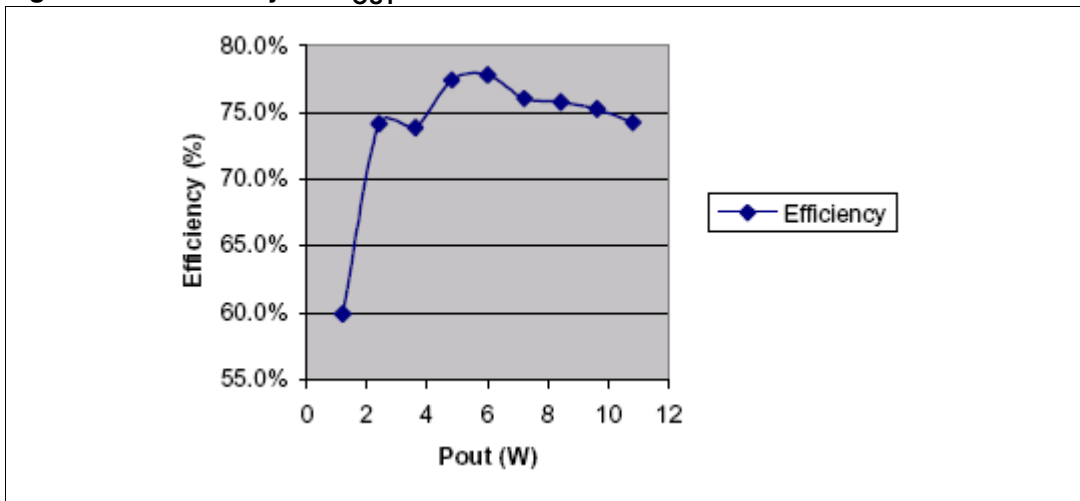

Figure 5. Switching frequency ripple



## 2.2 Efficiency results

Figure 6. Efficiency vs. P<sub>OUT</sub>



The typical efficiency of the board is about 75%. The efficiency measurements are taken at a nominal input voltage of 120 V<sub>AC</sub>. Figure 6 shows the efficiency measurements that are taken when the output power is varied from 1W to 10W. Figure 7 meanwhile shows the efficiency measurement taken when the input voltage is varied from 90 to 264 V<sub>AC</sub> at the maximum output power rating of 10W. The average measured efficiency is 75%.

Figure 7. Efficiency vs. V<sub>IN</sub>

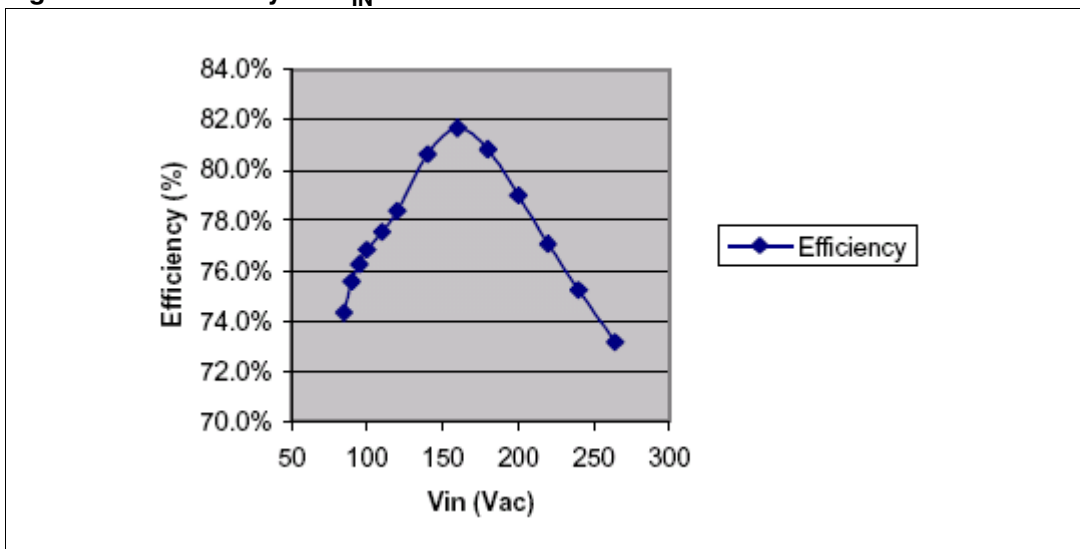

## 2.3 Load response

At an input voltage of 120 V<sub>AC</sub>, the output load is stepped from 50% to 100% load (0.42A to 0.84A). The settling time is found to be 400μs and the dynamic regulation is 120mV or 1%. The resulting waveforms are shown in Figure 8.

Figure 8. Transient load response

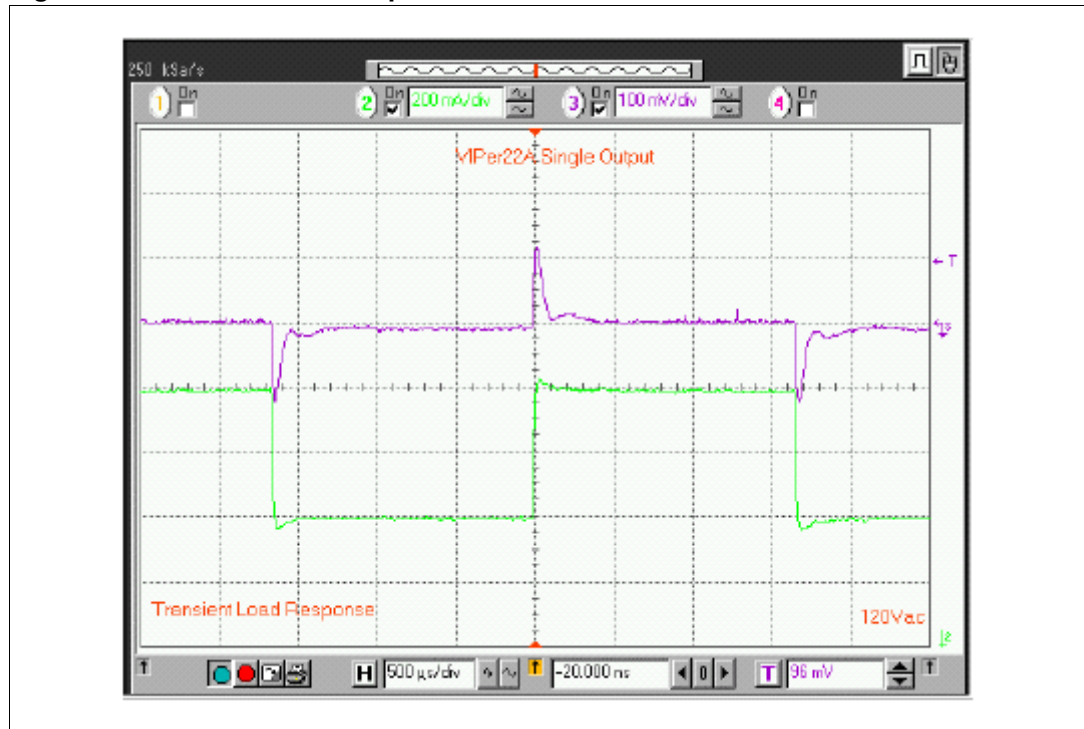

## 2.4 Line and load regulation

The output voltages are measured over the entire input voltage range, that is between 90 and 264 V<sub>AC</sub>. This gives the line regulation as shown in [Figure 9](#). As can be seen from the graph, the output voltage remained at a constant +12V output. The line regulation therefore is 0%.

Figure 9. Line regulation

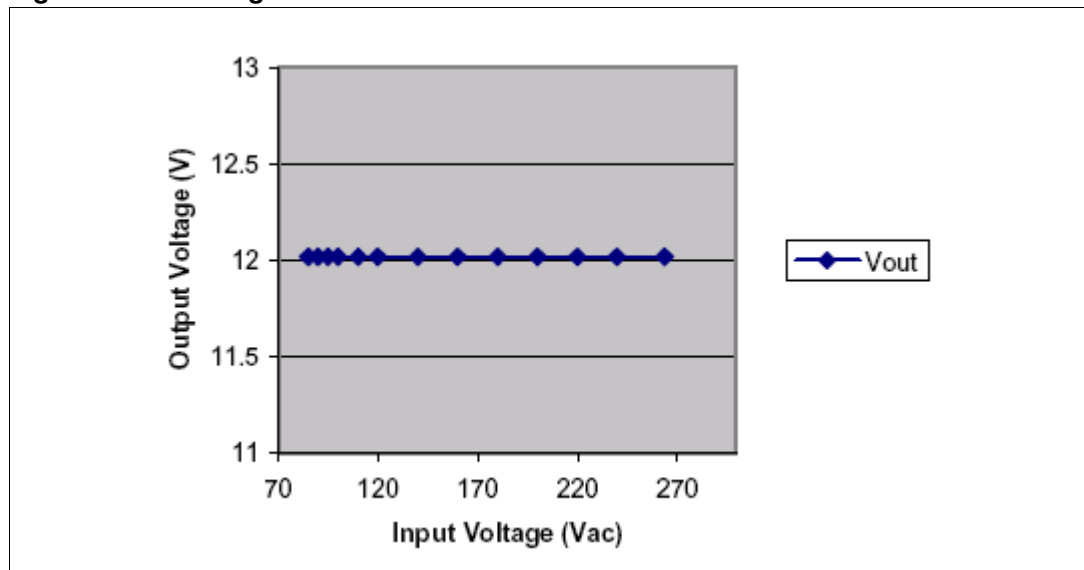

The output voltage has also been measured in a range of loads, as shown in [Figure 10](#) at a nominal input voltage of 120 V<sub>AC</sub>. The load regulation is approximately 0.125% when tested from 10% to 100% of full load on the output.

**Figure 10. Load regulation**

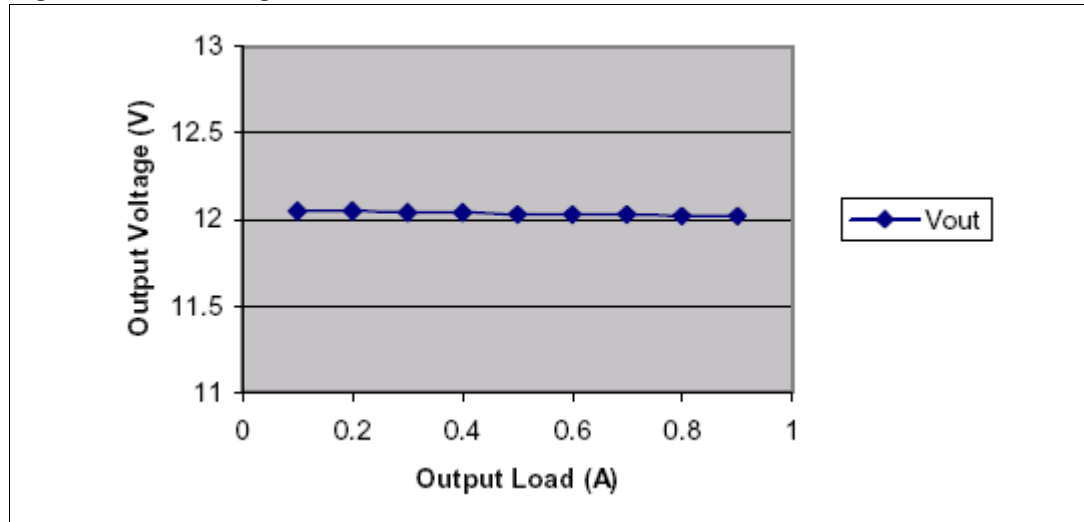

## 2.5 EMI emissions

**Figure 11. EMI conducted emissions**

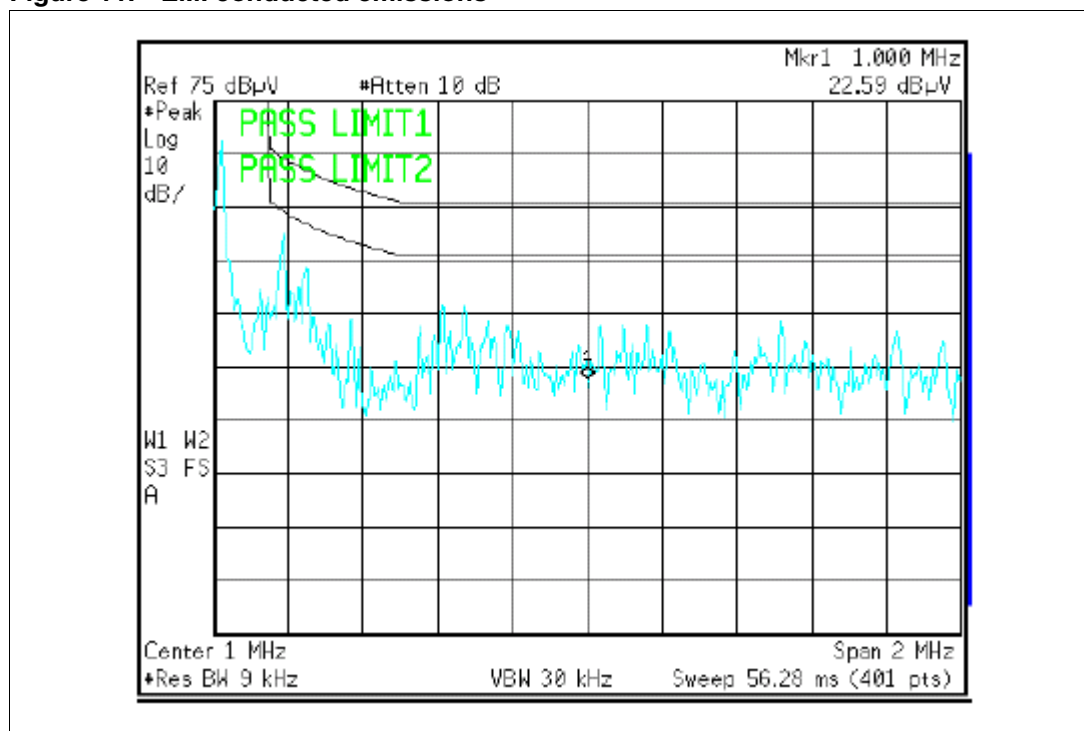

The results shown in [Figure 11](#) indicate that the unit passes EN55022 Class B EMI conducted emission tests.



### 3 Waveforms

Figure 12 shows the drain current ( $I_{DRAIN}$ ) and drain voltage ( $V_{DS}$ ) during normal operation at full load. The converter works in the Discontinuous mode as illustrated by the waveforms.

Figure 12.  $V_{DS}$  and drain current

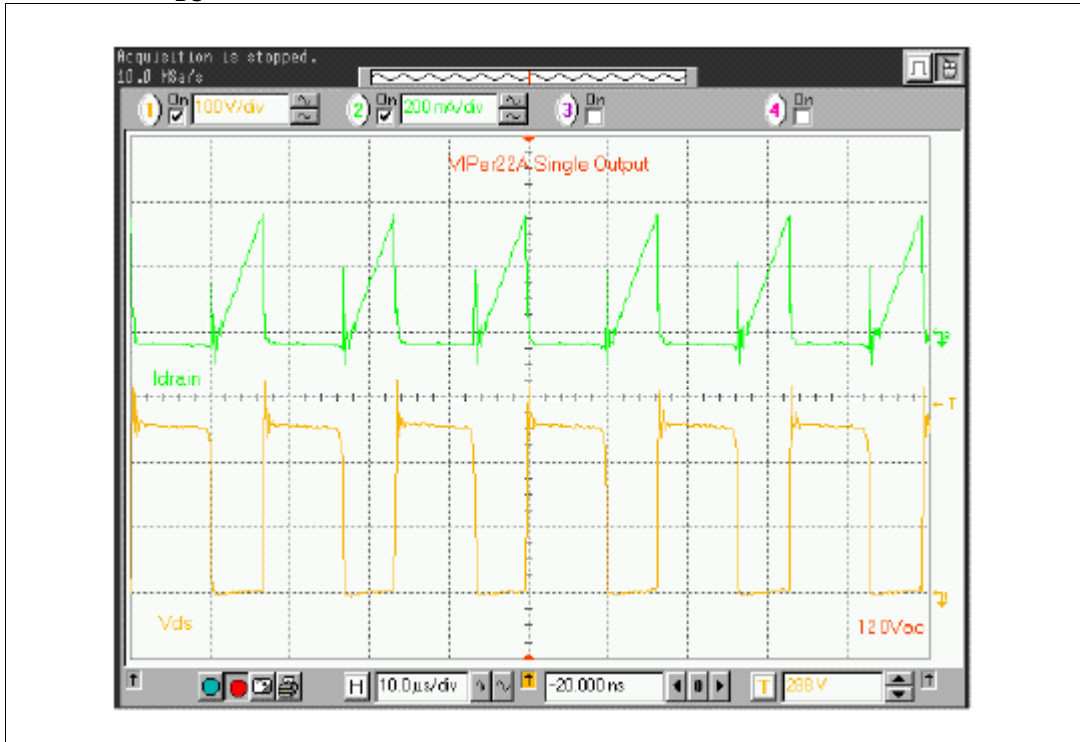

### 4 Output current and voltage capability

The output voltage and current can be set to a different value by changing components as shown in Table 2.

Table 2. Changes in output voltage and current

V <sub>out</sub>	T1	R8	R5	C9	C10
5.0V 2.0A	CVP32-006	2.49KΩ 1%	2.49KΩ 1%	2x1000μF/25V	100μF/25V
12V 0.84A	CVP32-001	13.3KΩ 1%	3.48KΩ 1%	1000μF/25V	100μF/25V
15V 0.67A	CVP32-005	14.7KΩ 1%	2.94KΩ 1%	680μF/35V	100μF/35V
24V 0.42A	CVP32-007	13.0KΩ 1%	1.50KΩ 1%	220μF/50V	100μF/50V

## 5 Thermal considerations

The VIPer22A is a single-sided reference board that uses a wide two-ounce copper pad area to act as a heat sink for the VIPer22ADIP. All other traces use one-ounce copper.

At 65° C, the measured case temperature is 90° C, therefore making the junction temperature 123.7° C.

## 6 Blue angel standard

The Blue Angel standard is a German certification for products and services that have environmentally friendly aspects. It requires that the power supply consumes less than 1W of power when in Standby mode.

The total power consumption of this reference board is less than 1W when working in Standby Burst mode. [Table 3](#) lists the input power consumption ( $P_{IN}$ ) values at different input voltages when measured with zero loads at the output.

**Table 3. Input power consumption in No-Load conditions**

Input voltage	Input Wattage at No Load
115 V <sub>AC</sub>	200 mW
230 V <sub>AC</sub>	366 mW

In order to keep the total input power to be less than 1W total, a minimum load of 40 mA is needed when using a 120 V<sub>AC</sub> input supply.

Therefore, the reference board complies with the Blue Angel standard.

## 7 Transformer specifications

Figure 13. Mechanical drawings of the transformer

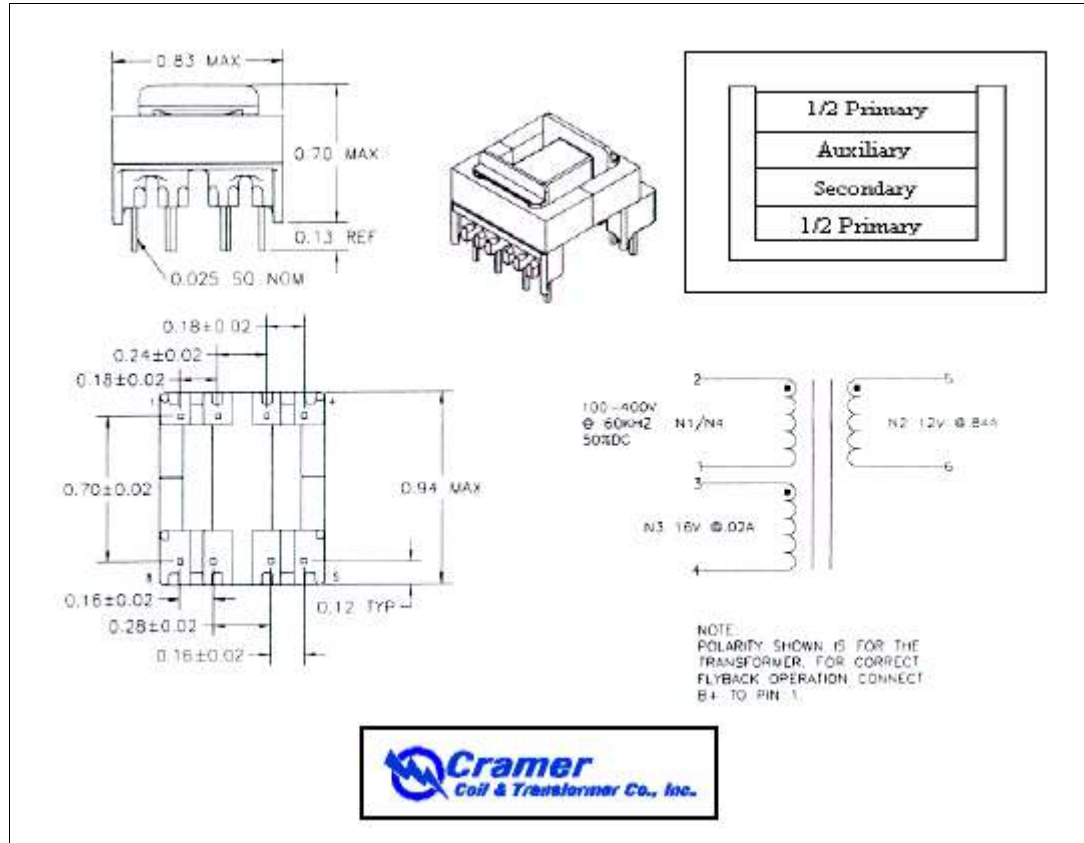

The transformer is designed and manufactured by Cramer Coil and Transformer Co.

Table 4 lists the electrical characteristics of the transformer.

Table 4. Electrical characteristics of the transformer

Parameter	Values
Primary inductance	2.25mH ± 10%
Primary leakage inductance	19.9µH typical
HIPOT (N1, N3, N4 to N2)	5500VAC, 1Sec
DCR (N1/N4)	2.87Ω typical
DCR (N2)	0.07Ω typical
DCR (N3)	1.26Ω typical
Turns ratio (N1/N4:N2)	1:0.127
Turns ratio (N1/N4:N3)	1:0.167

When the VIPer22A (U1) is on, energy is stored in the primary winding of transformer (1-2), TX1. This energy is transferred to the auxiliary winding (3-4), and to the output (5-6) when the VIPer22A is off. The auxiliary winding provides the bias voltage for the VIPer22A at pin 4 (V<sub>DD</sub>).

## 8 Component list

**Table 5. Component list**

Quantity	Reference	Description
1	BR1	KBP210GDI
1	C1	0.047 $\mu$ F/250V boxcap
1	C2	22 $\mu$ F/400V electrolytic
1	C3	100pF 1kV ceramic
1	C4	22 $\mu$ F/25V electrolytic
1	C6	0.01 $\mu$ F/50V ceramic
1	C8	4.7nF/250V Y cap
1	C9	1500 $\mu$ F/25V electrolytic
1	C10	100 $\mu$ F/25V electrolytic
1	C11	0.01 $\mu$ F/50V ceramic
1	C12	10 $\mu$ F/400V electrolytic
1	D1	1N4148
1	D2	STMicroelectronics BYW98-200
1	F1	0.5A Fuse
2	J1, J2	Connectors
1	L1	2x30mH common-mode line choke
1	L2	Coilcraft 10 $\mu$ H inductor
1	R1	50 $\Omega$ 5% 1W wire wound
1	R2	2K $\Omega$ 5% 1/2W
1	R4	68 $\Omega$ 5% 1/4W
1	R5	3.48K $\Omega$ 1% 1/4W
1	R6	470 $\Omega$ 5% 1/4W
1	R7	9.1k $\Omega$ 5% 1/4W
1	R8	13.3K $\Omega$ 1% 1/4W
1	T1	Cramer coil transformer CVP32-001
1	U1	STMicroelectronics VIPer22A
1	U2	H11A817A or LTV817 optocoupler
1	U3	STMicroelectronics TL431
1	W1, W2	Jumper wire

Figure 14. Schematic diagram

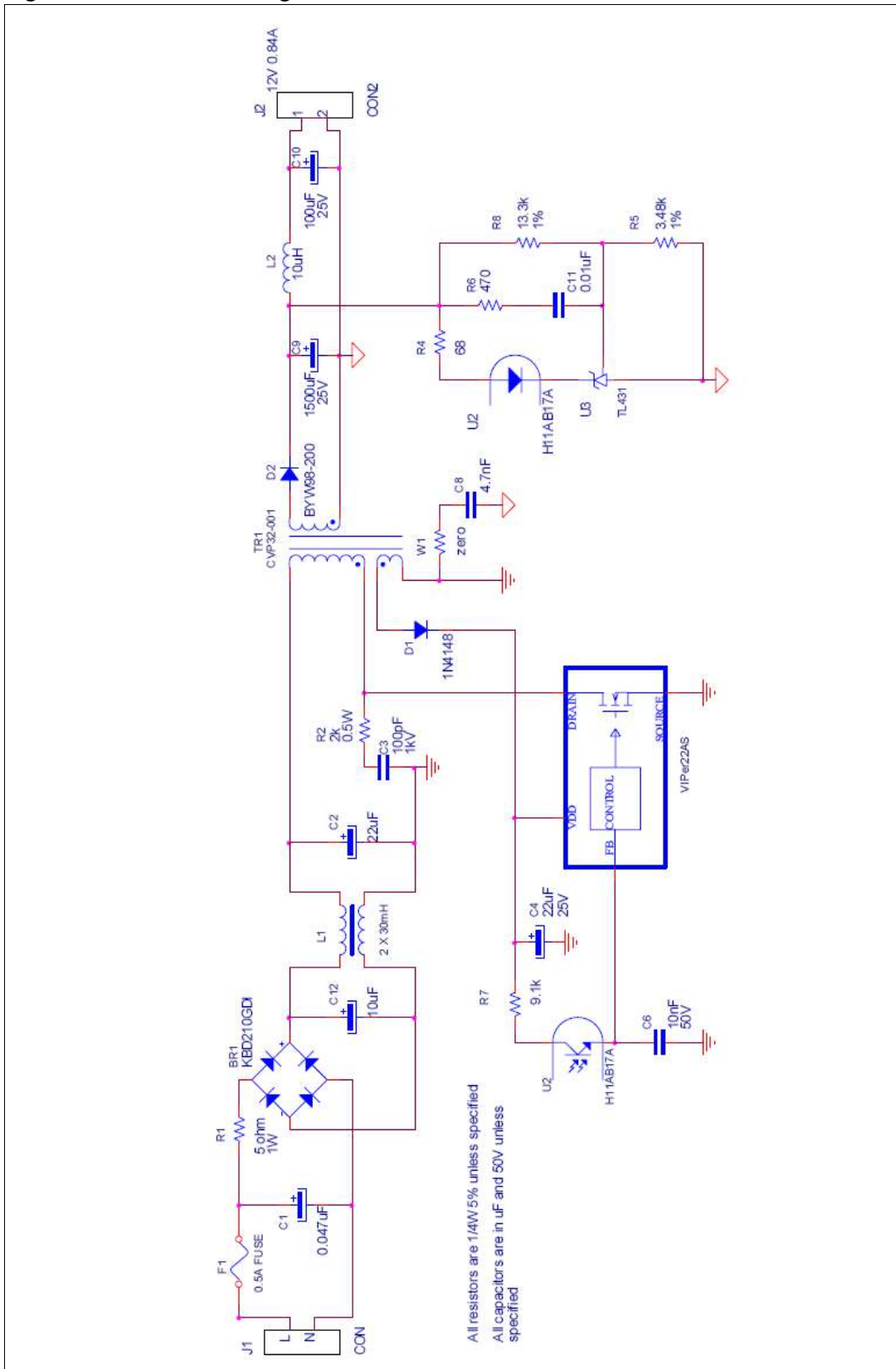

## 9 Revision history

**Table 6. Revision history**

Date	Revision	Changes
Jul-2003	1	Initial release.
17-Jul-2006	2	Converted to new corporate template. Minor editing changes.

**Please Read Carefully:**

Information in this document is provided solely in connection with ST products. STMicroelectronics NV and its subsidiaries ("ST") reserve the right to make changes, corrections, modifications or improvements, to this document, and the products and services described herein at any time, without notice.

All ST products are sold pursuant to ST's terms and conditions of sale.

Purchasers are solely responsible for the choice, selection and use of the ST products and services described herein, and ST assumes no liability whatsoever relating to the choice, selection or use of the ST products and services described herein.

No license, express or implied, by estoppel or otherwise, to any intellectual property rights is granted under this document. If any part of this document refers to any third party products or services it shall not be deemed a license grant by ST for the use of such third party products or services, or any intellectual property contained therein or considered as a warranty covering the use in any manner whatsoever of such third party products or services or any intellectual property contained therein.

**UNLESS OTHERWISE SET FORTH IN ST'S TERMS AND CONDITIONS OF SALE ST DISCLAIMS ANY EXPRESS OR IMPLIED WARRANTY WITH RESPECT TO THE USE AND/OR SALE OF ST PRODUCTS INCLUDING WITHOUT LIMITATION IMPLIED WARRANTIES OF MERCHANTABILITY, FITNESS FOR A PARTICULAR PURPOSE (AND THEIR EQUIVALENTS UNDER THE LAWS OF ANY JURISDICTION), OR INFRINGEMENT OF ANY PATENT, COPYRIGHT OR OTHER INTELLECTUAL PROPERTY RIGHT.**

**UNLESS EXPRESSLY APPROVED IN WRITING BY AN AUTHORIZED ST REPRESENTATIVE, ST PRODUCTS ARE NOT RECOMMENDED, AUTHORIZED OR WARRANTED FOR USE IN MILITARY, AIR CRAFT, SPACE, LIFE SAVING, OR LIFE SUSTAINING APPLICATIONS, NOR IN PRODUCTS OR SYSTEMS WHERE FAILURE OR MALFUNCTION MAY RESULT IN PERSONAL INJURY, DEATH, OR SEVERE PROPERTY OR ENVIRONMENTAL DAMAGE. ST PRODUCTS WHICH ARE NOT SPECIFIED AS "AUTOMOTIVE GRADE" MAY ONLY BE USED IN AUTOMOTIVE APPLICATIONS AT USER'S OWN RISK.**

Resale of ST products with provisions different from the statements and/or technical features set forth in this document shall immediately void any warranty granted by ST for the ST product or service described herein and shall not create or extend in any manner whatsoever, any liability of ST.

ST and the ST logo are trademarks or registered trademarks of ST in various countries.

Information in this document supersedes and replaces all information previously supplied.

The ST logo is a registered trademark of STMicroelectronics. All other names are the property of their respective owners.

© 2006 STMicroelectronics - All rights reserved

STMicroelectronics group of companies

Australia - Belgium - Brazil - Canada - China - Czech Republic - Finland - France - Germany - Hong Kong - India - Israel - Italy - Japan - Malaysia - Malta - Morocco - Singapore - Spain - Sweden - Switzerland - United Kingdom - United States of America

[www.st.com](http://www.st.com)

