

TLV4110, TLV4111, TLV4112, TLV4113 FAMILY OF HIGH OUTPUT DRIVE OPERATIONAL AMPLIFIERS WITH SHUTDOWN

SLOS289E – DECEMBER 1999 – REVISED SEPTEMBER 2006

- High Output Drive . . . >300 mA
- Rail-To-Rail Output
- Unity-Gain Bandwidth . . . 2.7 MHz
- Slew Rate . . . 1.5 V/ μ s
- Supply Current . . . 700 μ A/Per Channel
- Supply Voltage Range . . . 2.5 V to 6 V
- Specified Temperature Range:
 - $T_A = 0^\circ\text{C}$ to 70°C . . . Commercial Grade
 - $T_A = -40^\circ\text{C}$ to 125°C . . . Industrial Grade
- Universal OpAmp EVM

Operational Amplifier

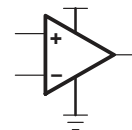

TLV4112
D, DGN, OR P PACKAGE
(TOP VIEW)

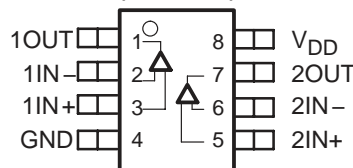

description

The TLV411x single supply operational amplifiers provide output currents in excess of 300 mA at 5 V. This enables standard pin-out amplifiers to be used as high current buffers or in coil driver applications. The TLV4110 and TLV4113 come with a shutdown feature.

The TLV411x is available in the ultra small MSOP PowerPAD™ package, which offers the exceptional thermal impedance required for amplifiers delivering high current levels.

All TLV411x devices are offered in PDIP, SOIC (single and dual) and MSOP PowerPAD (dual).

FAMILY PACKAGE TABLE

DEVICE	NUMBER OF CHANNELS	PACKAGE TYPES			SHUTDOWN	UNIVERSAL EVM BOARD
		MSOP	PDIP	SOIC		
TLV4110	1	8	8	8	Yes	Refer to the EVM Selection Guide (Lit# SLOU060)
TLV4111	1	8	8	8	—	
TLV4112	2	8	8	8	—	
TLV4113	2	10	14	14	Yes	

HIGH-LEVEL OUTPUT VOLTAGE
vs
HIGH-LEVEL OUTPUT CURRENT

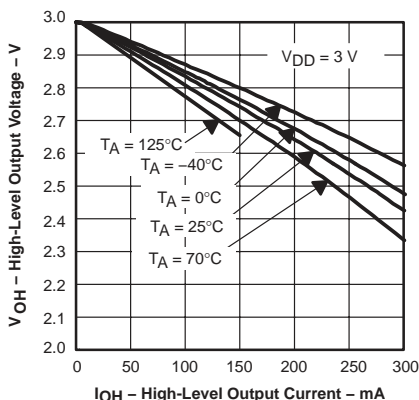

LOW-LEVEL OUTPUT VOLTAGE
vs
LOW-LEVEL OUTPUT CURRENT

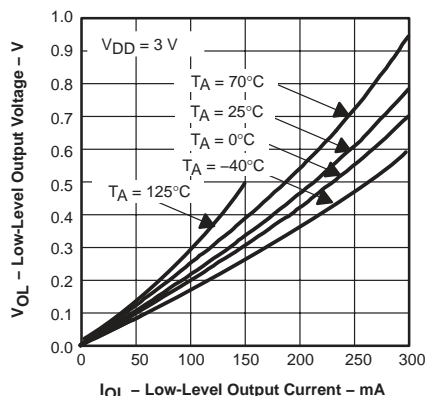

Please be aware that an important notice concerning availability, standard warranty, and use in critical applications of Texas Instruments semiconductor products and disclaimers thereto appears at the end of this data sheet.

PowerPAD is a trademark of Texas Instruments. All other trademarks are the property of their respective owners.

PRODUCTION DATA information is current as of publication date. Products conform to specifications per the terms of Texas Instruments standard warranty. Production processing does not necessarily include testing of all parameters.



POST OFFICE BOX 655303 • DALLAS, TEXAS 75265

Copyright © 1999–2006, Texas Instruments Incorporated

TLV4110, TLV4111, TLV4112, TLV4113 FAMILY OF HIGH OUTPUT DRIVE OPERATIONAL AMPLIFIERS WITH SHUTDOWN

SLOS289E – DECEMBER 1999 – REVISED SEPTEMBER 2006

TLV4110 AND TLV4111 AVAILABLE OPTIONS

T _A	PACKAGED DEVICES			
	SMALL OUTLINE (D)†‡	MSOP		PLASTIC DIP (P)
		SMALL OUTLINE (DGN)†	SYMBOL	
0°C to 70°C	TLV4110CD	TLV4110CDGN	xxTIAHL	TLV4110CP
	TLV4111CD	TLV4111CDGN	xxTIAHN	TLV4111CP
-40°C to 125°C	TLV4110ID	TLV4110IDGN	xxTIAHM	TLV4110IP
	TLV4111ID	TLV4111IDGN	xxTIAHO	TLV4111IP

† This package is available taped and reeled. To order this packaging option, add an R suffix to the part number (e.g., TLV4110CDR).

‡ In the SOIC package, the maximum RMS output power is thermally limited to 350 mW; 700 mW peaks can be driven, as long as the RMS value is less than 350 mW.

TLV4112 AND TLV4113 AVAILABLE OPTIONS

T _A	PACKAGED DEVICES					
	SMALL OUTLINE (D)†‡	MSOP				PLASTIC DIP (P)
		SMALL OUTLINE (DGN)†	SYMBOL	SMALL OUTLINE (DGQ)†	SYMBOL	
0°C to 70°C	TLV4112CD	TLV4112DGN	xxTIAHP	—	—	TLV4112CP
	TLV4113CD	—	—	TLV4113CDGQ	xxTIAHR	TLV4113CN
-40°C to 125°C	TLV4112ID	TLV4112IDGN	xxTIAHQ	—	—	TLV4112IP
	TLV4113ID	—	—	TLV4113IDGQ	xxTIAHS	TLV4113IN

† This package is available taped and reeled. To order this packaging option, add an R suffix to the part number (e.g., TLV4112CDR).

‡ In the SOIC package, the maximum RMS output power is thermally limited to 350 mW; 700 mW peaks can be driven, as long as the RMS value is less than 350 mW.

TLV411x PACKAGE PIN OUTS

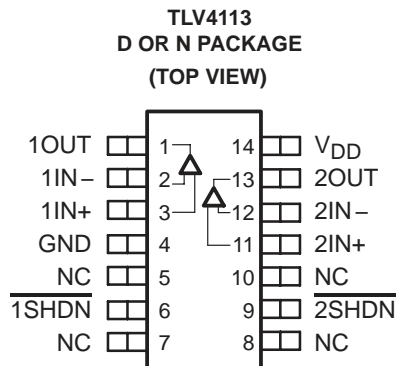
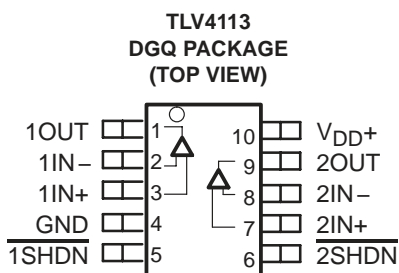
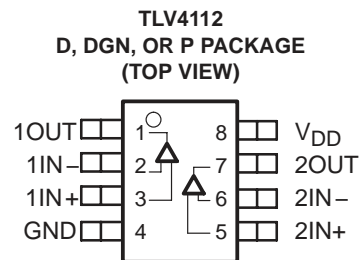
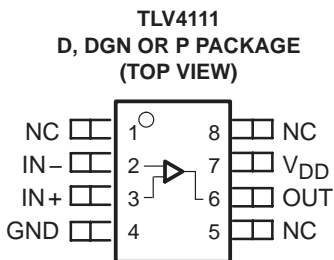
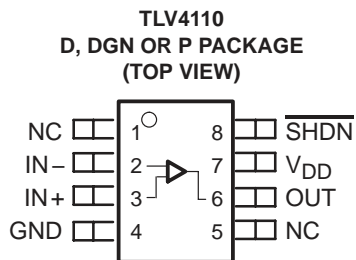

NC – No internal connection

TLV4110, TLV4111, TLV4112, TLV4113 FAMILY OF HIGH OUTPUT DRIVE OPERATIONAL AMPLIFIERS WITH SHUTDOWN

SLOS289E – DECEMBER 1999 – REVISED SEPTEMBER 2006

absolute maximum ratings over operating free-air temperature range (unless otherwise noted)†

Supply voltage, V_{DD} (see Note 1)	7 V
Differential input voltage, V_{ID}	$\pm V_{DD}$
Input voltage range, V_I	$\pm V_{DD}$
Output current, I_O (see Note 2)	800 mA
Continuous /RMS output current, I_O (each output of amplifier):	
$T_J \leq 105^\circ\text{C}$	350 mA
$T_J \leq 150^\circ\text{C}$	110 mA
Peak output current, I_O (each output of amplifier):	
$T_J \leq 105^\circ\text{C}$	500 mA
$T_J \leq 150^\circ\text{C}$	155 mA
Continuous total power dissipation	See Dissipation Rating Table
Operating free-air temperature range, T_A :	
C suffix	0°C to 70°C
I suffix	-40°C to 125°C
Maximum junction temperature, T_J	150°C
Storage temperature range, T_{stg}	-65°C to 150°C
Lead temperature 1,6 mm (1/16 inch) from case for 10 seconds	260°C

† Stresses beyond those listed under “absolute maximum ratings” may cause permanent damage to the device. These are stress ratings only, and functional operation of the device at these or any other conditions beyond those indicated under “recommended operating conditions” is not implied. Exposure to absolute-maximum-rated conditions for extended periods may affect device reliability.

- NOTES: 1. All voltage values, except differential voltages, are with respect to GND.
2. To prevent permanent damage the die temperature must not exceed the maximum junction temperature.

DISSIPATION RATING TABLE

PACKAGE	θ_{JC} ($^\circ\text{C}/\text{W}$)	θ_{JA} ($^\circ\text{C}/\text{W}$)	$T_A \leq 25^\circ\text{C}$ POWER RATING	$T_A = 125^\circ\text{C}$ POWER RATING
D (8)	38.3	176	710 mW	142 mW
D (14)	26.9	122.3	1022 mW	204.4 mW
DGN (8)‡	4.7	52.7	2.37 W	474.4 mW
DGQ (10)‡	4.7	52.3	2.39 W	478 mW
P (8)	41	104	1200 mW	240.4 mW
N (14)	32	78	1600 mW	320.5 mW

‡ See The Texas Instruments document, *PowerPAD Thermally Enhanced Package Application Report* (literature number SLMA002), for more information on the PowerPAD package. The thermal data was measured on a PCB layout based on the information in the section entitled *Texas Instruments Recommended Board for PowerPAD* on page 33 of the before mentioned document.

recommended operating conditions

		MIN	MAX	UNIT
Supply voltage, V_{DD}		2.5	6	V
Common-mode input voltage range, V_{ICR}		0	$V_{DD}-1.5$	V
Operating free-air temperature, T_A	C-suffix	0	70	$^\circ\text{C}$
	I-suffix	-40	125	
Shutdown turn-on/off voltage level§	V(on)	$V_{DD} = 3\text{ V}$	2.1	V
		$V_{DD} = 5\text{ V}$	3.8	
	V(off)	$V_{DD} = 3\text{ V}$	0.9	
		$V_{DD} = 5\text{ V}$	1.65	

§ Relative to GND



TLV4110, TLV4111, TLV4112, TLV4113 FAMILY OF HIGH OUTPUT DRIVE OPERATIONAL AMPLIFIERS WITH SHUTDOWN

SLOS289E – DECEMBER 1999 – REVISED SEPTEMBER 2006

electrical characteristics at recommend operating conditions, $V_{DD} = 3\text{ V}$ and 5 V (unless otherwise noted)

dc performance

PARAMETER		TEST CONDITIONS		T_A^\dagger	MIN	TYP	MAX	UNITS
V_{IO}	Input offset voltage	$V_{IC} = V_{DD}/2,$ $R_L = 100\ \Omega,$	$V_O = V_{DD}/2,$ $R_S = 50\ \Omega$	25°C	175	3500		μV
				Full range		4000		
α_{VIO}	Offset voltage draft			25°C		3		$\mu\text{V}/^\circ\text{C}$
CMRR	Common-mode rejection ratio	$V_{DD} = 3\text{ V},$ $R_S = 50\ \Omega$	$V_{IC} = 0\text{ to }2\text{ V},$	25°C		63		dB
			$V_{IC} = 0\text{ to }4\text{ V},$	25°C		68		
A_{VD}	Large-signal differential voltage amplification	$V_{DD} = 3\text{ V},$ $V_{O(PP)} = 0\text{ to }1\text{ V}$	$R_L = 100\ \Omega$	25°C	78	84		dB
				Full range		67		
			$R_L = 10\ \text{k}\Omega$	25°C	85	100		
		Full range			75			
		$V_{DD} = 5\text{ V},$ $V_{O(PP)} = 0\text{ to }3\text{ V}$	$R_L = 100\ \Omega$	25°C	88	94		
				Full range		75		
$R_L = 10\ \text{k}\Omega$	25°C		90	110				
	Full range		85					

† Full range is 0°C to 70°C for C suffix and -40°C to 125°C for I suffix. If not specified, full range is -40°C to 125°C.

input characteristics

PARAMETER		TEST CONDITIONS		T_A^\dagger	MIN	TYP	MAX	UNITS
I_{IO}	Input offset current	$V_{IC} = V_{DD}/2$	TLV411xC	25°C	0.3	25		pA
				Full range		50		
			TLV411xI	Full range		250		
I_{IB}	Input bias current	$V_O = V_{DD}/2,$ $R_S = 50\ \Omega$	TLV411xC	25°C	0.3	50		pA
				Full range		100		
			TLV411xI	Full range		500		
$r_{i(d)}$	Differential input resistance			25°C		1000		$\text{G}\Omega$
C_{IC}	Common-mode input capacitance	$f = 100\ \text{Hz}$		25°C		5		pF

† Full range is 0°C to 70°C for C suffix and -40°C to 125°C for I suffix. If not specified, full range is -40°C to 125°C.

TLV4110, TLV4111, TLV4112, TLV4113 FAMILY OF HIGH OUTPUT DRIVE OPERATIONAL AMPLIFIERS WITH SHUTDOWN

SLOS289E – DECEMBER 1999 – REVISED SEPTEMBER 2006

electrical characteristics at specified free-air temperature, $V_{DD} = 3\text{ V}$ and 5 V (unless otherwise noted) (continued)

output characteristics

PARAMETER	TEST CONDITIONS	T_A †	MIN	TYP	MAX	UNITS
V_{OH} High-level output voltage	$V_{DD} = 3\text{ V}$, $V_{IC} = V_{DD}/2$	$I_{OH} = -10\text{ mA}$	25°C	2.7	2.97	V
			Full range	2.7		
		$I_{OH} = -100\text{ mA}$	25°C	2.6	2.73	
			Full range	2.6		
	$V_{DD} = 5\text{ V}$, $V_{IC} = V_{DD}/2$	$I_{OH} = -10\text{ mA}$	25°C	4.7	4.96	V
			Full range	4.7		
		$I_{OH} = -100\text{ mA}$	25°C	4.6	4.76	
			Full range	4.6		
$I_{OH} = -200\text{ mA}$		25°C	4.45	4.6		
		-40°C to 85°C	4.35			
V_{OL} Low-level output voltage	$V_{DD} = 3\text{ V}$ and 5 V , $V_{IC} = V_{DD}/2$	$I_{OL} = 10\text{ mA}$	25°C	0.03	0.1	V
			Full range		0.1	
		$I_{OL} = 100\text{ mA}$	25°C	0.33	0.4	
			Full range		0.55	
	$V_{DD} = 5\text{ V}$, $V_{IC} = V_{DD}/2$	$I_{OL} = 200\text{ mA}$	25°C	0.38	0.6	
			-40°C to 85°C		0.7	
		$I_{OL} = 10\text{ mA}$	25°C			
			Full range			
I_O Output current‡	Measured at 0.5 V from rail	$V_{DD} = 3\text{ V}$	25°C	±220		mA
		$V_{DD} = 5\text{ V}$		±320		
I_{OS} Short-circuit output current‡	Sourcing	25°C	800		mA	
	Sinking		800			

† Full range is 0°C to 70°C for C suffix and -40°C to 125°C for I suffix. If not specified, full range is -40°C to 125°C.

‡ When driving output currents in excess of 200 mA, the MSOP PowerPAD package is required for thermal dissipation.

power supply

PARAMETER	TEST CONDITIONS	T_A	MIN	TYP	MAX	UNITS
I_{DD} Supply current (per channel)	$V_O = V_{DD}/2$	25°C		700	1000	μA
		Full range			1500	
PSRR Power supply rejection ratio ($\Delta V_{DD} / \Delta V_{IO}$)	$V_{DD} = 2.7\text{ to }3.3\text{ V}$, No load, $V_{IC} = V_{DD}/2\text{ V}$	25°C	70	82	dB	
		Full range	65			
	$V_{DD} = 4.5\text{ to }5.5\text{ V}$, No load, $V_{IC} = V_{DD}/2\text{ V}$	25°C	70	79		
		Full range	65			

† Full range is 0°C to 70°C for C suffix and -40°C to 125°C for I suffix. If not specified, full range is -40°C to 125°C.



TLV4110, TLV4111, TLV4112, TLV4113 FAMILY OF HIGH OUTPUT DRIVE OPERATIONAL AMPLIFIERS WITH SHUTDOWN

SLOS289E – DECEMBER 1999 – REVISED SEPTEMBER 2006

electrical characteristics at specified free-air temperature, $V_{DD} = 3\text{ V}$ and 5 V (unless otherwise noted) (continued)

dynamic performance

PARAMETER		TEST CONDITIONS		T_A^\dagger	MIN	TYP	MAX	UNITS
GBWP	Gain bandwidth product	$R_L = 100\ \Omega$	$C_L = 10\ \text{pF}$	25°C		2.7		MHz
SR	Slew rate at unity gain	$V_{O(pp)} = 2\text{ V}$, $R_L = 100\ \Omega$, $C_L = 10\ \text{pF}$	$V_{DD} = 3\text{ V}$	25°C	0.8	1.57		V/ μs
				Full range	0.55			
			$V_{DD} = 5\text{ V}$	25°C	1	1.57		
				Full range	0.7			
ϕ_M	Phase margin	$R_L = 100\ \Omega$,	$C_L = 10\ \text{pF}$	25°C			66	
	Gain margin						16	
t_s	Settling time	$V(\text{STEP})_{pp} = 1\text{ V}$, $A_V = -1$, $C_L = 10\ \text{pF}$, $R_L = 100\ \Omega$	0.1%	25°C			0.7	μs
			0.01%				1.3	

† Full range is 0°C to 70°C for C suffix and -40°C to 125°C for I suffix. If not specified, full range is -40°C to 125°C.

noise/distortion performance

PARAMETER		TEST CONDITIONS		T_A	MIN	TYP	MAX	UNITS
THD+N	Total harmonic distortion plus noise	$V_{O(pp)} = V_{DD}/2\text{ V}$, $R_L = 100\ \Omega$, $f = 100\ \text{Hz}$	$A_V = 1$	25°C			0.025	
			$A_V = 10$				0.035	
			$A_V = 100$				0.15	
V_n	Equivalent input noise voltage	$f = 100\ \text{Hz}$	$f = 10\ \text{kHz}$	25°C			55	nV/ $\sqrt{\text{Hz}}$
							10	
I_n	Equivalent input noise current	$f = 1\ \text{kHz}$		25°C			0.31	fA/ $\sqrt{\text{Hz}}$

shutdown characteristics

PARAMETER		TEST CONDITIONS		T_A^\dagger	MIN	TYP	MAX	UNITS
$I_{DD}(\text{SHDN})$	Supply current in shutdown mode (per channel) (TLV4110, TLV4113)	$\overline{\text{SHDN}} = 0\text{ V}$		25°C	3.4	10		μA
				Full range			15	
$t(\text{ON})$	Amplifier turn-on time ‡	$R_L = 100\ \Omega$		25°C			1	μs
$t(\text{Off})$	Amplifier turn-off time ‡						3.3	

† Full range is 0°C to 70°C for C suffix and -40°C to 125°C for I suffix. If not specified, full range is -40°C to 125°C.

‡ Disable time and enable time are defined as the interval between application of the logic signal to SHDN and the point at which the supply current has reached half its final value.

TLV4110, TLV4111, TLV4112, TLV4113
FAMILY OF HIGH OUTPUT DRIVE OPERATIONAL
AMPLIFIERS WITH SHUTDOWN

SLOS289E – DECEMBER 1999 – REVISED SEPTEMBER 2006

TYPICAL CHARACTERISTICS

Table of Graphs

			FIGURE
V_{IO}	Input offset voltage	vs Common-mode input voltage	1, 2
CMRR	Common-mode rejection ratio	vs Frequency	3
V_{OH}	High-level output voltage	vs High-level output current	4, 6
V_{OL}	Low-level output voltage	vs Low-level output current	5, 7
Z_o	Output impedance	vs Frequency	8
I_{DD}	Supply current	vs Supply voltage	9
k_{SVR}	Power supply voltage rejection ratio	vs Frequency	10
A_{VD}	Differential voltage amplification and phase	vs Frequency	11
	Gain-bandwidth product	vs Supply voltage	12
SR	Slew rate	vs Supply voltage	13
		vs Temperature	14
	Total harmonic distortion+noise	vs Frequency	15
V_n	Equivalent input voltage noise	vs Frequency	16
	Phase margin	vs Capacitive load	17
	Voltage-follower signal pulse response		18, 19
	Inverting large-signal pulse response		20, 21
	Small-signal inverting pulse response		22
	Crosstalk	vs Frequency	23
	Shutdown forward and reverse isolation		24
	Shutdown supply current	vs Free-air temperature	25
	Shutdown supply current/output voltage		26

TLV4110, TLV4111, TLV4112, TLV4113 FAMILY OF HIGH OUTPUT DRIVE OPERATIONAL AMPLIFIERS WITH SHUTDOWN

SLOS289E – DECEMBER 1999 – REVISED SEPTEMBER 2006

TYPICAL CHARACTERISTICS

**INPUT OFFSET VOLTAGE
vs
COMMON-MODE INPUT VOLTAGE**

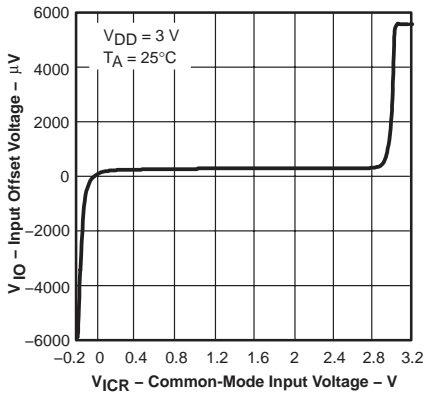

Figure 1

**INPUT OFFSET VOLTAGE
vs
COMMON-MODE INPUT VOLTAGE**

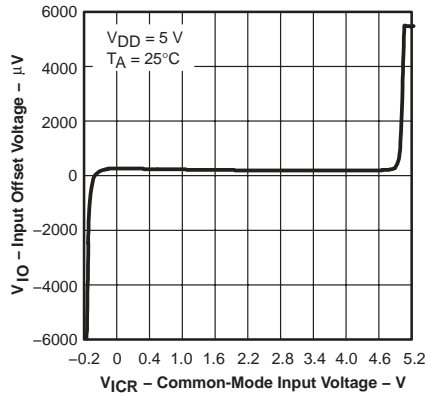

Figure 2

**COMMON-MODE REJECTION RATIO
vs
FREQUENCY**

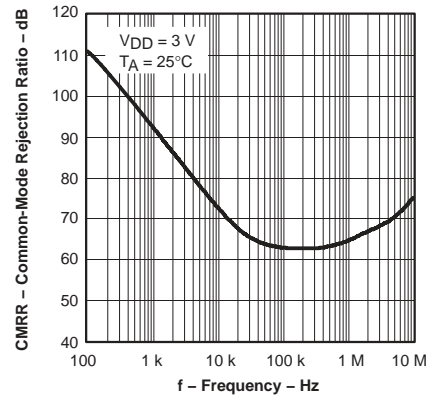

Figure 3

**HIGH-LEVEL OUTPUT VOLTAGE
vs
HIGH-LEVEL OUTPUT CURRENT**

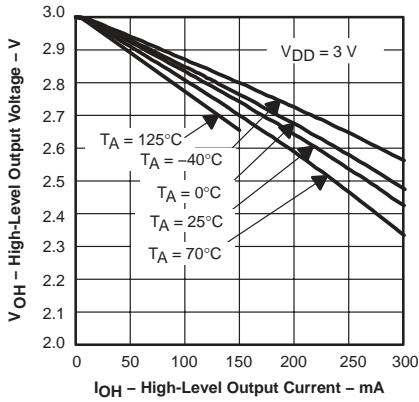

Figure 4

**LOW-LEVEL OUTPUT VOLTAGE
vs
LOW-LEVEL OUTPUT CURRENT**

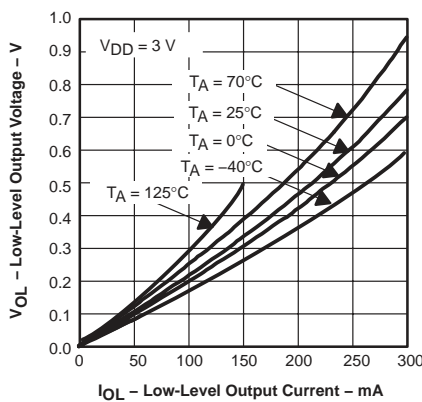

Figure 5

**HIGH-LEVEL OUTPUT VOLTAGE
vs
HIGH-LEVEL OUTPUT CURRENT**

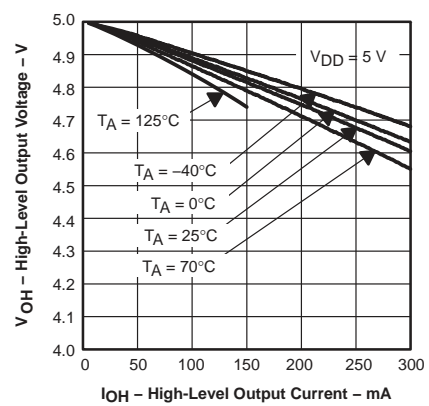

Figure 6

**LOW-LEVEL OUTPUT VOLTAGE
vs
LOW-LEVEL OUTPUT CURRENT**

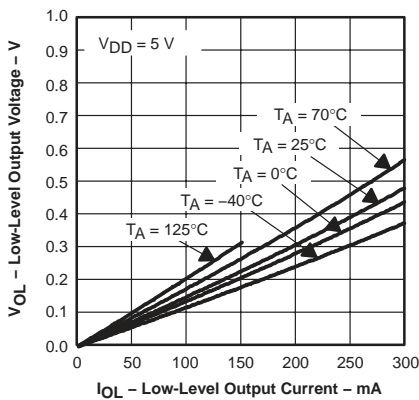

Figure 7

**OUTPUT IMPEDANCE
vs
FREQUENCY**

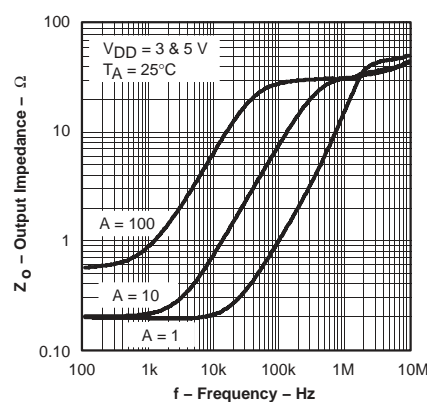

Figure 8

**SUPPLY CURRENT
vs
SUPPLY VOLTAGE**

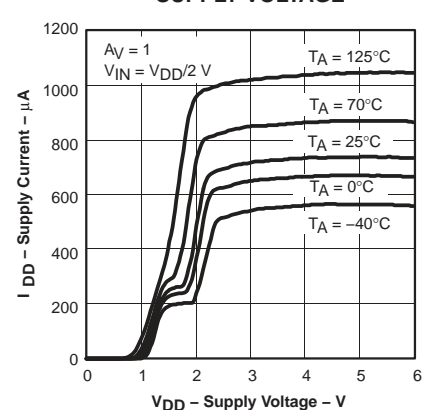

Figure 9

TYPICAL CHARACTERISTICS

POWER SUPPLY REJECTION RATIO
 VS
 FREQUENCY

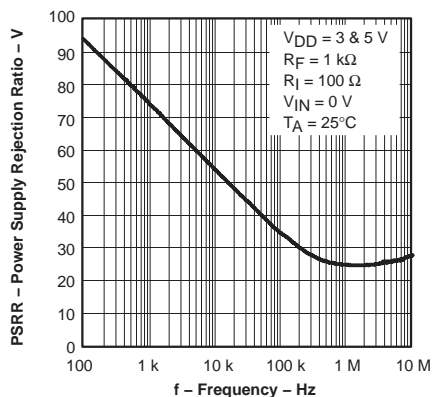

Figure 10

DIFFERENTIAL VOLTAGE
 AMPLIFICATION AND PHASE
 VS
 FREQUENCY

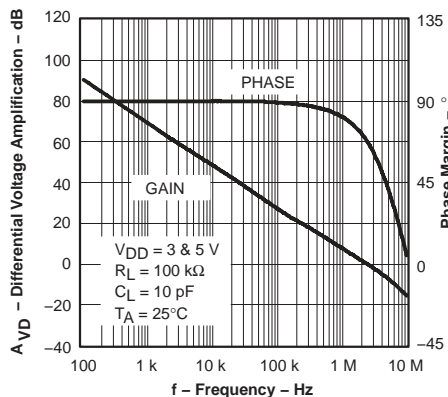

Figure 11

GAIN-BANDWIDTH PRODUCT
 VS
 SUPPLY VOLTAGE

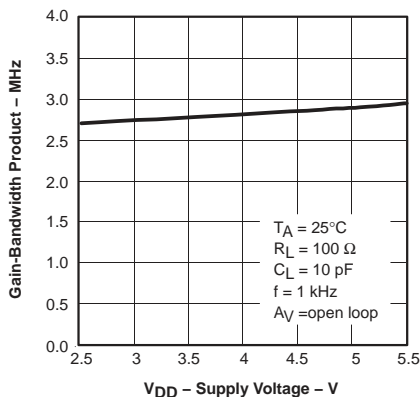

Figure 12

SLEW RATE
 VS
 SUPPLY VOLTAGE

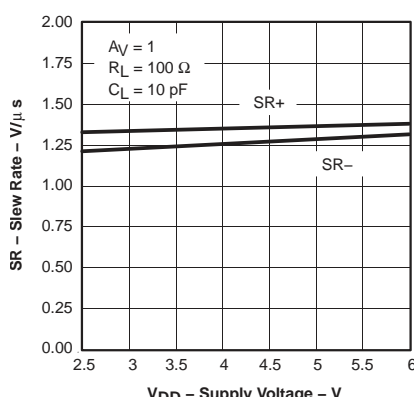

Figure 13

SLEW RATE
 VS
 TEMPERATURE

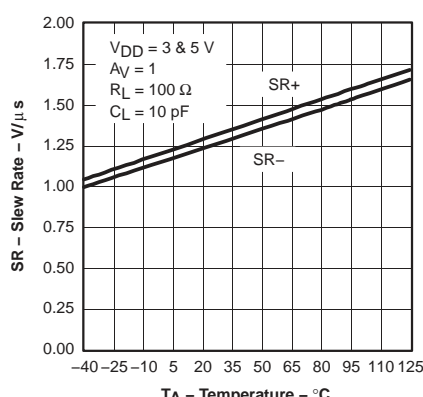

Figure 14

TOTAL HARMONIC DISTORTION+NOISE
 VS
 FREQUENCY

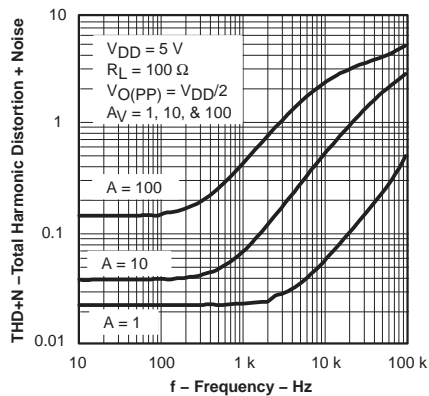

Figure 15

EQUIVALENT INPUT VOLTAGE NOISE
 VS
 FREQUENCY

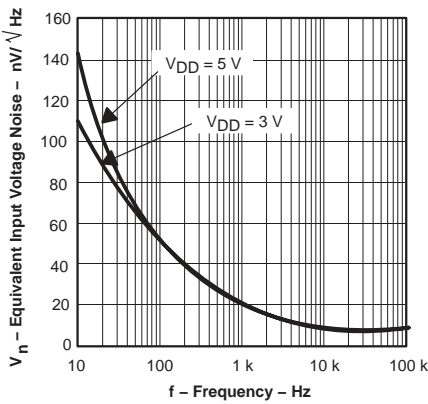

Figure 16

PHASE MARGIN
 VS
 CAPACITIVE LOAD

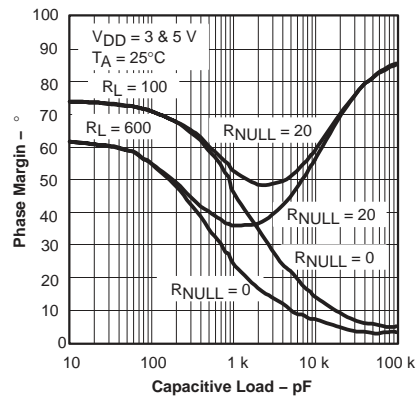

Figure 17

TLV4110, TLV4111, TLV4112, TLV4113

FAMILY OF HIGH OUTPUT DRIVE OPERATIONAL AMPLIFIERS WITH SHUTDOWN

SLOS289E – DECEMBER 1999 – REVISED SEPTEMBER 2006

TYPICAL CHARACTERISTICS

**VOLTAGE-FOLLOWER
LARGE-SIGNAL PULSE RESPONSE**

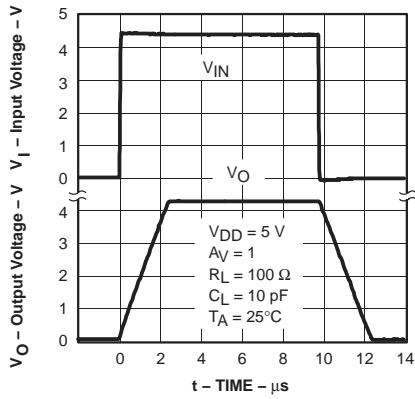

Figure 18

**VOLTAGE-FOLLOWER
SMALL-SIGNAL PULSE RESPONSE**

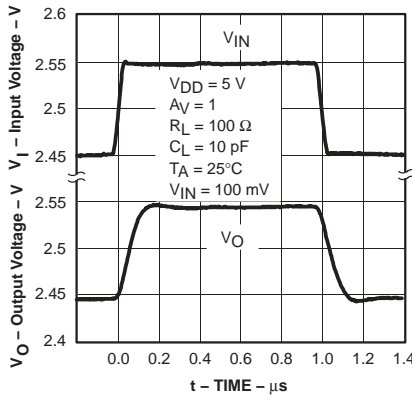

Figure 19

**INVERTING LARGE-SIGNAL
PULSE RESPONSE**

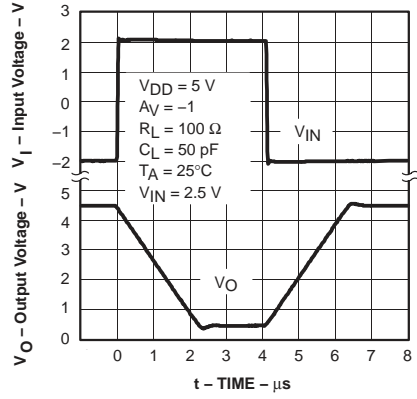

Figure 20

**INVERTING LARGE-SIGNAL
PULSE RESPONSE**

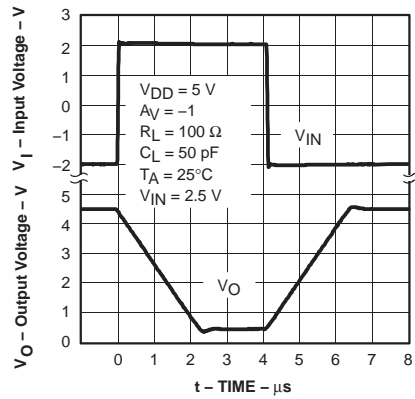

Figure 21

**SMALL-SIGNAL INVERTING
PULSE RESPONSE**

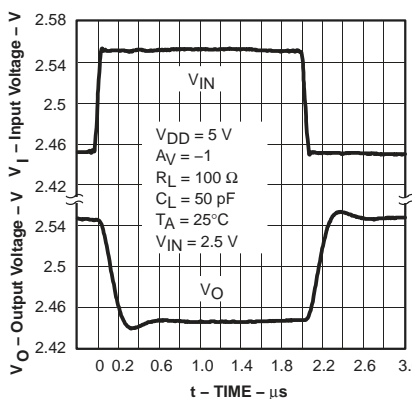

Figure 22

**CROSSTALK
vs
FREQUENCY**

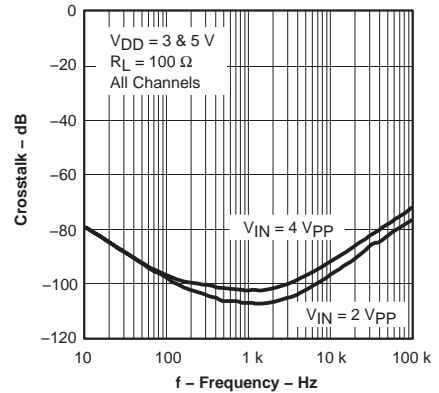

Figure 23

**SHUTDOWN FORWARD AND
REVERSE ISOLATION**

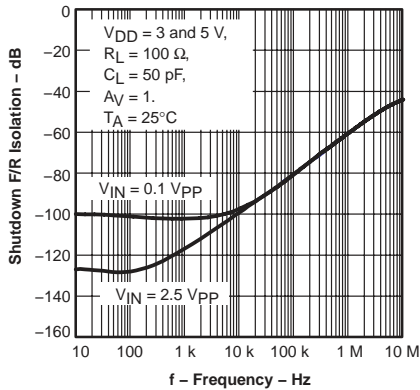

Figure 24

**SHUTDOWN SUPPLY CURRENT
vs
FREE-AIR TEMPERATURE**

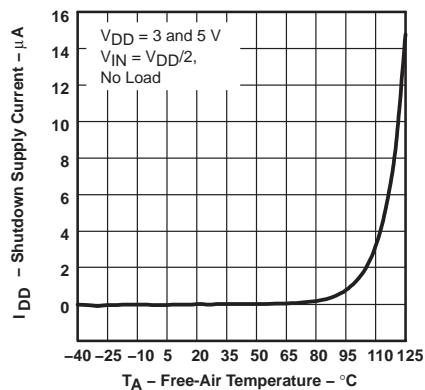

Figure 25

TYPICAL CHARACTERISTICS

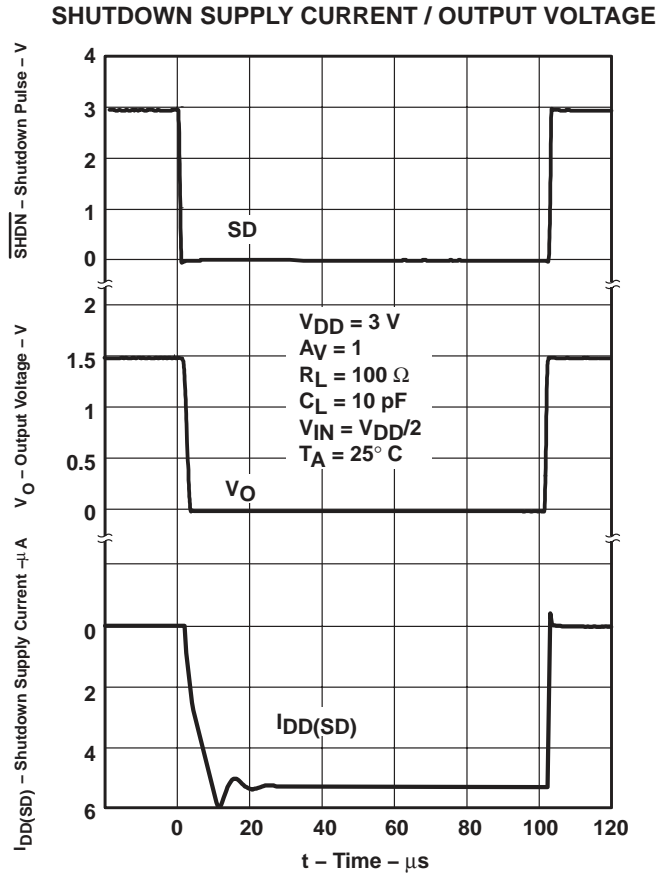

Figure 26

TLV4110, TLV4111, TLV4112, TLV4113 FAMILY OF HIGH OUTPUT DRIVE OPERATIONAL AMPLIFIERS WITH SHUTDOWN

SLOS289E – DECEMBER 1999 – REVISED SEPTEMBER 2006

APPLICATION INFORMATION

shutdown function

Two members of the TLV411x family (TLV4110/3) have a shutdown terminal for conserving battery life in portable applications. When the shutdown terminal is tied low, the supply current is reduced to just nano amps per channel, the amplifier is disabled, and the outputs are placed in a high impedance mode. In order to save power in shutdown mode, an external pullup resistor is required, therefore, to enable the amplifier the shutdown terminal must be pulled high. When the shutdown terminal is left floating, care should be taken to ensure that parasitic leakage current at the shutdown terminal does not inadvertently place the operational amplifier into shutdown.

driving a capacitive load

When the amplifier is configured in this manner, capacitive loading directly on the output will decrease the device's phase margin leading to high frequency ringing or oscillations. Therefore, for capacitive loads of greater than 1 nF, it is recommended that a resistor be placed in series (R_{NULL}) with the output of the amplifier, as shown in Figure 27. A maximum value of 20 Ω should work well for most applications.

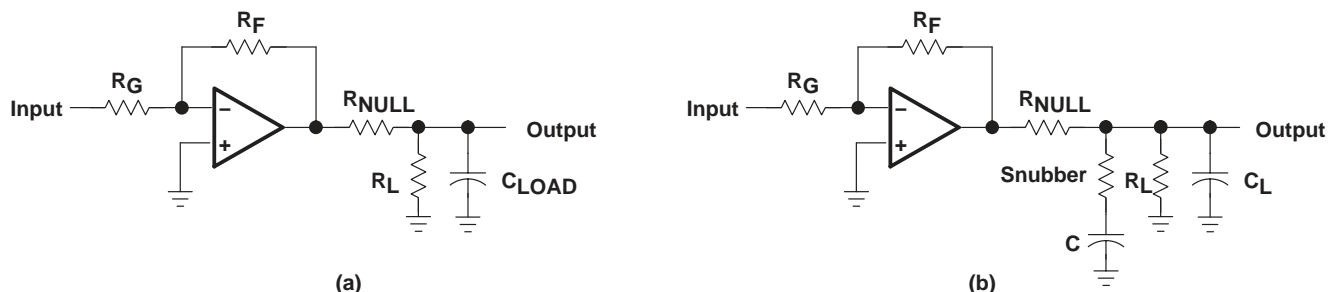

Figure 27. Driving a Capacitive Load

offset voltage

The output offset voltage, (V_{OO}) is the sum of the input offset voltage (V_{IO}) and both input bias currents (I_{IB}) times the corresponding gains. The following schematic and formula can be used to calculate the output offset voltage:

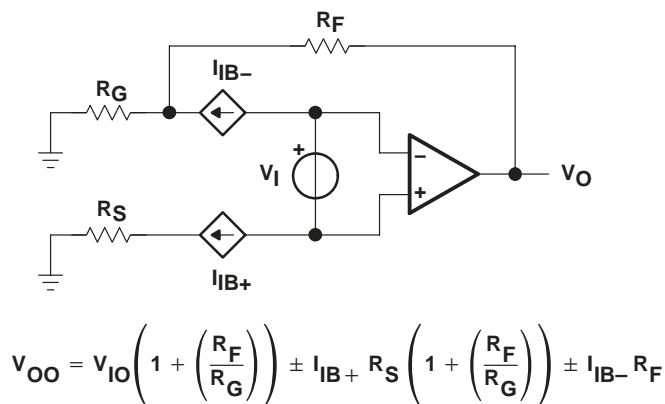

Figure 28. Output Offset Voltage Model

APPLICATION INFORMATION

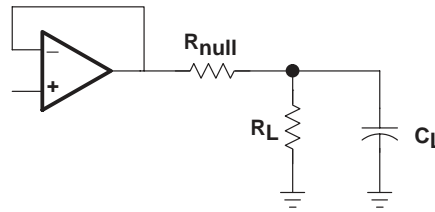

Figure 29

general power design considerations

When driving heavy loads at high junction temperatures there is an increased probability of electromigration affecting the long term reliability of ICs. Therefore for this not to be an issue either:

- The output current must be limited (at these high junction temperatures).
- or
- The junction temperature must be limited.

The maximum continuous output current at a die temperature 150°C will be 1/3 of the current at 105°C.

The junction temperature will be dependent on the ambient temperature around the IC, thermal impedance from the die to the ambient and power dissipated within the IC.

$$T_J = T_A + \theta_{JA} \times P_{DIS}$$

Where:

P_{DIS} is the IC power dissipation and is equal to the output current multiplied by the voltage dropped across the output of the IC.

θ_{JA} is the thermal impedance between the junction and the ambient temperature of the IC.

T_J is the junction temperature.

T_A is the ambient temperature.

Reducing one or more of these factors results in a reduced die temperature. The 8-pin SOIC (small outline integrated circuit) has a thermal impedance from junction to ambient of 176°C/W. For this reason it is recommended that the maximum power dissipation of the 8-pin SOIC package be limited to 350 mW, with peak dissipation of 700 mW as long as the RMS value is less than 350 mW.

The use of the MSOP PowerPAD™ dramatically reduces the thermal impedance from junction to case. And with correct mounting, the reduced thermal impedance greatly increases the IC's permissible power dissipation and output current handling capability. For example, the power dissipation of the PowerPAD™ is increased to above 1 W. Sinusoidal and pulse-width modulated output signals also increase the output current capability. The equivalent dc current is proportional to the square-root of the duty cycle:

$$I_{DC(EQ)} = I_{Cont} \times \sqrt{\text{duty cycle}}$$

CURRENT DUTY CYCLE AT PEAK RATED CURRENT	EQUIVALENT DC CURRENT AS A PERCENTAGE OF PEAK
100	100
70	84
50	71

Note that with an operational amplifier, a duty cycle of 70% would often result in the op amp sourcing current 70% of the time and sinking current 30%, therefore, the equivalent dc current would still be 0.84 times the continuous current rating at a particular junction temperature.

TLV4110, TLV4111, TLV4112, TLV4113 FAMILY OF HIGH OUTPUT DRIVE OPERATIONAL AMPLIFIERS WITH SHUTDOWN

SLOS289E – DECEMBER 1999 – REVISED SEPTEMBER 2006

APPLICATION INFORMATION

general PowerPAD design considerations

The TLV411x is available in a thermally-enhanced PowerPAD family of packages. These packages are constructed using a downset leadframe upon which the die is mounted [see Figure 30(a) and Figure 30(b)]. This arrangement results in the lead frame being exposed as a thermal pad on the underside of the package [see Figure 30(c)]. Because this thermal pad has direct thermal contact with the die, excellent thermal performance can be achieved by providing a good thermal path away from the thermal pad.

The PowerPAD package allows for both assembly and thermal management in one manufacturing operation. During the surface-mount solder operation (when the leads are being soldered), the thermal pad must be soldered to a copper area underneath the package. Through the use of thermal paths within this copper area, heat can be conducted away from the package into either a ground plane or other heat dissipating device.

Soldering the PowerPAD to the PCB is always recommended, even with applications that have low-power dissipation. This provides the necessary thermal and mechanical connection between the lead frame die pad and the PCB.

The PowerPAD package represents a breakthrough in combining the small area and ease of assembly of surface mount with mechanical methods of heatsinking.

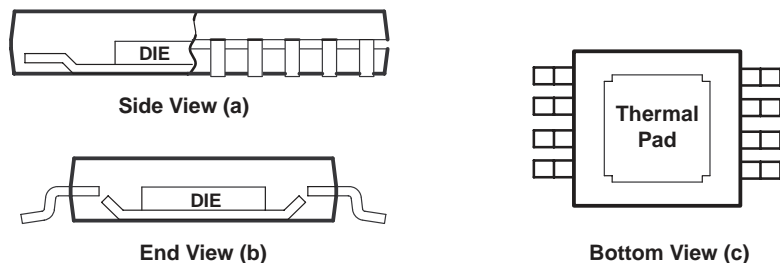

NOTE A: The thermal pad is electrically isolated from all terminals in the package.

Figure 30. Views of Thermally-Enhanced DGN Package

APPLICATION INFORMATION

Although there are many ways to properly heatsink the PowerPAD package, the following steps illustrate the recommended approach.

general PowerPAD design considerations (continued)

1. The thermal pad must be connected to the most negative supply voltage on the device, GND.
2. Prepare the PCB with a top side etch pattern as illustrated in the thermal land pattern mechanical drawings at the end of this document. There should be etch for the leads as well as etch for the thermal pad.
3. Place five holes in the area of the thermal pad. These holes should be 13 mils in diameter. Keep them small so that solder wicking through the holes is not a problem during reflow.
4. Additional vias may be placed anywhere along the thermal plane outside of the thermal pad area. This helps dissipate the heat generated by the TLV411x IC. These additional vias may be larger than the 13-mil diameter vias directly under the thermal pad. They can be larger because they are not in the thermal pad area to be soldered so that wicking is not a problem.
5. Connect all holes to the internal ground plane that is at the same voltage potential as the device GND pin.
6. When connecting these holes to the ground plane, do not use the typical web or spoke via connection methodology. Web connections have a high thermal resistance connection that is useful for slowing the heat transfer during soldering operations. This makes the soldering of vias that have plane connections easier. In this application, however, low thermal resistance is desired for the most efficient heat transfer. Therefore, the holes under the TLV411x PowerPAD package should make their connection to the internal ground plane with a complete connection around the entire circumference of the plated-through hole.
7. The top-side solder mask should leave the terminals of the package and the thermal pad area with its five holes exposed. The bottom-side solder mask should cover the five holes of the thermal pad area. This prevents solder from being pulled away from the thermal pad area during the reflow process.
8. Apply solder paste to the exposed thermal pad area and all of the IC terminals.
9. With these preparatory steps in place, the TLV411x IC is simply placed in position and run through the solder reflow operation as any standard surface-mount component. This results in a part that is properly installed.

For a given θ_{JA} , the maximum power dissipation is shown in Figure 31 and is calculated by the following formula:

$$P_D = \left(\frac{T_{MAX} - T_A}{\theta_{JA}} \right)$$

Where:

P_D = Maximum power dissipation of TLV411x IC (watts)

T_{MAX} = Absolute maximum junction temperature (150°C)

T_A = Free-ambient air temperature (°C)

θ_{JA} = $\theta_{JC} + \theta_{CA}$

θ_{JC} = Thermal coefficient from junction to case

θ_{CA} = Thermal coefficient from case to ambient air (°C/W)

TLV4110, TLV4111, TLV4112, TLV4113
FAMILY OF HIGH OUTPUT DRIVE OPERATIONAL
AMPLIFIERS WITH SHUTDOWN

SLOS289E – DECEMBER 1999 – REVISED SEPTEMBER 2006

APPLICATION INFORMATION

general PowerPAD design considerations (continued)

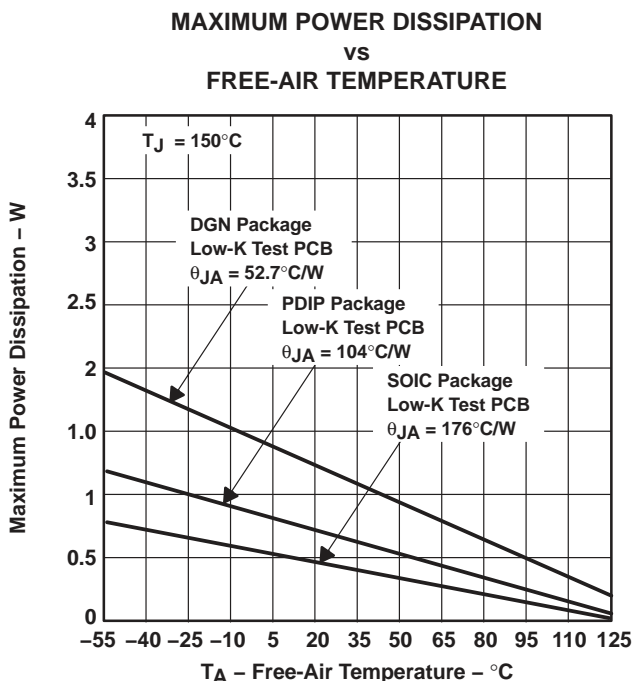

NOTE A: Results are with no air flow and using JEDEC Standard Low-K test PCB.

Figure 31. Maximum Power Dissipation vs Free-Air Temperature

The next consideration is the package constraints. The two sources of heat within an amplifier are quiescent power and output power. The designer should never forget about the quiescent heat generated within the device, especially multi-amplifier devices. Because these devices have linear output stages (Class A-B), most of the heat dissipation is at low output voltages with high output currents.

The other key factor when dealing with power dissipation is how the devices are mounted on the PCB. The PowerPAD devices are extremely useful for heat dissipation. But, the device should always be soldered to a copper plane to fully use the heat dissipation properties of the PowerPAD. The SOIC package, on the other hand, is highly dependent on how it is mounted on the PCB. As more trace and copper area is placed around the device, θ_{JA} decreases and the heat dissipation capability increases. The currents and voltages shown in these graphs are for the total package. For the dual amplifier packages, the sum of the RMS output currents and voltages should be used to choose the proper package.



PACKAGING INFORMATION

Orderable Device	Status (1)	Package Type	Package Drawing	Pins	Package Qty	Eco Plan (2)	Lead finish/ Ball material (6)	MSL Peak Temp (3)	Op Temp (°C)	Device Marking (4/5)	Samples
TLV4110ID	LIFEBUY	SOIC	D	8	75	RoHS & Green	NIPDAU	Level-1-260C-UNLIM	-40 to 125	4110I	
TLV4110IDGNR	ACTIVE	HVSSOP	DGN	8	2500	RoHS & Green	NIPDAU	Level-1-260C-UNLIM	-40 to 125	AHM	Samples
TLV4110IDR	ACTIVE	SOIC	D	8	2500	RoHS & Green	NIPDAU	Level-1-260C-UNLIM	-40 to 125	4110I	Samples
TLV4110IP	LIFEBUY	PDIP	P	8	50	RoHS & Green	NIPDAU	N / A for Pkg Type	-40 to 125	TLV4110I	
TLV4111CD	LIFEBUY	SOIC	D	8	75	RoHS & Green	NIPDAU	Level-1-260C-UNLIM	0 to 70	4111C	
TLV4111CDGN	LIFEBUY	HVSSOP	DGN	8	80	RoHS & Green	NIPDAU	Level-1-260C-UNLIM	0 to 70	AHN	
TLV4111ID	LIFEBUY	SOIC	D	8	75	RoHS & Green	NIPDAU	Level-1-260C-UNLIM	-40 to 125	4111I	
TLV4111IDGN	LIFEBUY	HVSSOP	DGN	8	80	RoHS & Green	NIPDAU	Level-1-260C-UNLIM	-40 to 125	AHO	
TLV4111IDGNR	ACTIVE	HVSSOP	DGN	8	2500	RoHS & Green	NIPDAU	Level-1-260C-UNLIM	-40 to 125	AHO	Samples
TLV4111IDR	ACTIVE	SOIC	D	8	2500	RoHS & Green	NIPDAU	Level-1-260C-UNLIM	-40 to 125	4111I	Samples
TLV4112CD	ACTIVE	SOIC	D	8	75	RoHS & Green	NIPDAU	Level-1-260C-UNLIM	0 to 70	4112C	Samples
TLV4112CDGN	ACTIVE	HVSSOP	DGN	8	80	RoHS & Green	NIPDAU NIPDAUAG	Level-1-260C-UNLIM	0 to 70	AHP	Samples
TLV4112CP	LIFEBUY	PDIP	P	8	50	RoHS & Green	NIPDAU	N / A for Pkg Type	0 to 70	TLV4112C	
TLV4112ID	ACTIVE	SOIC	D	8	75	RoHS & Green	NIPDAU	Level-1-260C-UNLIM	-40 to 125	4112I	Samples
TLV4112IDGN	ACTIVE	HVSSOP	DGN	8	80	RoHS & Green	NIPDAU NIPDAUAG	Level-1-260C-UNLIM	-40 to 125	AHQ	Samples
TLV4112IDGNR	ACTIVE	HVSSOP	DGN	8	2500	RoHS & Green	NIPDAU NIPDAUAG	Level-1-260C-UNLIM	-40 to 125	AHQ	Samples
TLV4112IDR	ACTIVE	SOIC	D	8	2500	RoHS & Green	NIPDAU	Level-1-260C-UNLIM	-40 to 125	4112I	Samples
TLV4112IP	LIFEBUY	PDIP	P	8	50	RoHS & Green	NIPDAU	N / A for Pkg Type	-40 to 125	TLV4112I	
TLV4113ID	LIFEBUY	SOIC	D	14	50	RoHS & Green	NIPDAU	Level-1-260C-UNLIM	-40 to 125	4113I	
TLV4113IDGQ	ACTIVE	HVSSOP	DGQ	10	80	RoHS & Green	Call TI NIPDAU	Level-1-260C-UNLIM	-40 to 125	AHS	Samples
TLV4113IDGQR	ACTIVE	HVSSOP	DGQ	10	2500	RoHS & Green	NIPDAU	Level-1-260C-UNLIM	-40 to 125	AHS	Samples
TLV4113IN	LIFEBUY	PDIP	N	14	25	RoHS & Green	NIPDAU	N / A for Pkg Type	-40 to 125	TLV4113I	

(1) The marketing status values are defined as follows:

ACTIVE: Product device recommended for new designs.

LIFEBUY: TI has announced that the device will be discontinued, and a lifetime-buy period is in effect.

NRND: Not recommended for new designs. Device is in production to support existing customers, but TI does not recommend using this part in a new design.

PREVIEW: Device has been announced but is not in production. Samples may or may not be available.

OBSOLETE: TI has discontinued the production of the device.

⁽²⁾ **RoHS:** TI defines "RoHS" to mean semiconductor products that are compliant with the current EU RoHS requirements for all 10 RoHS substances, including the requirement that RoHS substance do not exceed 0.1% by weight in homogeneous materials. Where designed to be soldered at high temperatures, "RoHS" products are suitable for use in specified lead-free processes. TI may reference these types of products as "Pb-Free".

RoHS Exempt: TI defines "RoHS Exempt" to mean products that contain lead but are compliant with EU RoHS pursuant to a specific EU RoHS exemption.

Green: TI defines "Green" to mean the content of Chlorine (Cl) and Bromine (Br) based flame retardants meet JS709B low halogen requirements of ≤ 1000 ppm threshold. Antimony trioxide based flame retardants must also meet the ≤ 1000 ppm threshold requirement.

⁽³⁾ MSL, Peak Temp. - The Moisture Sensitivity Level rating according to the JEDEC industry standard classifications, and peak solder temperature.

⁽⁴⁾ There may be additional marking, which relates to the logo, the lot trace code information, or the environmental category on the device.

⁽⁵⁾ Multiple Device Markings will be inside parentheses. Only one Device Marking contained in parentheses and separated by a "~" will appear on a device. If a line is indented then it is a continuation of the previous line and the two combined represent the entire Device Marking for that device.

⁽⁶⁾ Lead finish/Ball material - Orderable Devices may have multiple material finish options. Finish options are separated by a vertical ruled line. Lead finish/Ball material values may wrap to two lines if the finish value exceeds the maximum column width.

Important Information and Disclaimer: The information provided on this page represents TI's knowledge and belief as of the date that it is provided. TI bases its knowledge and belief on information provided by third parties, and makes no representation or warranty as to the accuracy of such information. Efforts are underway to better integrate information from third parties. TI has taken and continues to take reasonable steps to provide representative and accurate information but may not have conducted destructive testing or chemical analysis on incoming materials and chemicals. TI and TI suppliers consider certain information to be proprietary, and thus CAS numbers and other limited information may not be available for release.

In no event shall TI's liability arising out of such information exceed the total purchase price of the TI part(s) at issue in this document sold by TI to Customer on an annual basis.

OTHER QUALIFIED VERSIONS OF TLV4113 :

- Enhanced Product : [TLV4113-EP](#)

NOTE: Qualified Version Definitions:

- Enhanced Product - Supports Defense, Aerospace and Medical Applications

TAPE AND REEL INFORMATION

QUADRANT ASSIGNMENTS FOR PIN 1 ORIENTATION IN TAPE



*All dimensions are nominal

Device	Package Type	Package Drawing	Pins	SPQ	Reel Diameter (mm)	Reel Width W1 (mm)	A0 (mm)	B0 (mm)	K0 (mm)	P1 (mm)	W (mm)	Pin1 Quadrant
TLV4110IDGNR	HVSSOP	DGN	8	2500	330.0	12.4	5.3	3.4	1.4	8.0	12.0	Q1
TLV4110IDR	SOIC	D	8	2500	330.0	12.4	6.4	5.2	2.1	8.0	12.0	Q1
TLV4111IDGNR	HVSSOP	DGN	8	2500	330.0	12.4	5.3	3.4	1.4	8.0	12.0	Q1
TLV4111IDR	SOIC	D	8	2500	330.0	12.4	6.4	5.2	2.1	8.0	12.0	Q1
TLV4112IDGNR	HVSSOP	DGN	8	2500	330.0	12.4	5.3	3.4	1.4	8.0	12.0	Q1
TLV4112IDGNR	HVSSOP	DGN	8	2500	330.0	12.4	5.3	3.4	1.4	8.0	12.0	Q1
TLV4112IDR	SOIC	D	8	2500	330.0	12.4	6.4	5.2	2.1	8.0	12.0	Q1
TLV4113IDGQR	HVSSOP	DGQ	10	2500	330.0	12.4	5.3	3.4	1.4	8.0	12.0	Q1

TAPE AND REEL BOX DIMENSIONS

*All dimensions are nominal

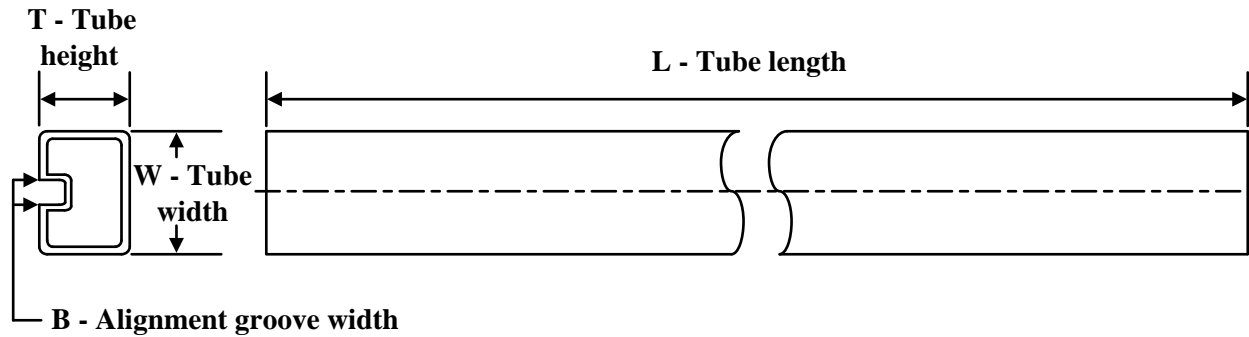
Device	Package Type	Package Drawing	Pins	SPQ	Length (mm)	Width (mm)	Height (mm)
TLV4110IDGNR	HVSSOP	DGN	8	2500	358.0	335.0	35.0
TLV4110IDR	SOIC	D	8	2500	340.5	336.1	25.0
TLV4111IDGNR	HVSSOP	DGN	8	2500	358.0	335.0	35.0
TLV4111IDR	SOIC	D	8	2500	340.5	336.1	25.0
TLV4112IDGNR	HVSSOP	DGN	8	2500	364.0	364.0	27.0
TLV4112IDGNR	HVSSOP	DGN	8	2500	358.0	335.0	35.0
TLV4112IDR	SOIC	D	8	2500	340.5	336.1	25.0
TLV4113IDGQR	HVSSOP	DGQ	10	2500	358.0	335.0	35.0

TUBE

*All dimensions are nominal

Device	Package Name	Package Type	Pins	SPQ	L (mm)	W (mm)	T (μm)	B (mm)
TLV4110ID	D	SOIC	8	75	507	8	3940	4.32
TLV4110IP	P	PDIP	8	50	506	13.97	11230	4.32
TLV4111CD	D	SOIC	8	75	507	8	3940	4.32
TLV4111ID	D	SOIC	8	75	507	8	3940	4.32
TLV4112CD	D	SOIC	8	75	507	8	3940	4.32
TLV4112CD	D	SOIC	8	75	505.46	6.76	3810	4
TLV4112CDGN	DGN	HVSSOP	8	80	330	6.55	500	2.88
TLV4112CP	P	PDIP	8	50	506	13.97	11230	4.32
TLV4112ID	D	SOIC	8	75	505.46	6.76	3810	4
TLV4112ID	D	SOIC	8	75	507	8	3940	4.32
TLV4112IDGN	DGN	HVSSOP	8	80	330	6.55	500	2.88
TLV4112IP	P	PDIP	8	50	506	13.97	11230	4.32
TLV4113ID	D	SOIC	14	50	507	8	3940	4.32
TLV4113IN	N	PDIP	14	25	506	13.97	11230	4.32

GENERIC PACKAGE VIEW

DGQ 10

PowerPAD™ HVSSOP - 1.1 mm max height

3 x 3, 0.5 mm pitch

PLASTIC SMALL OUTLINE

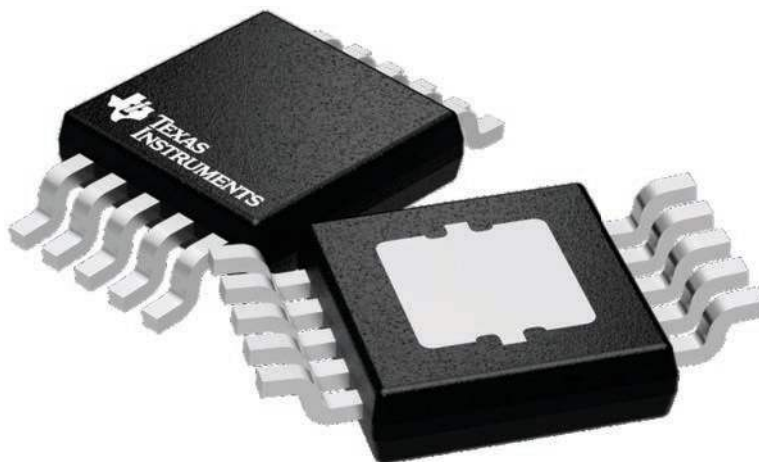

Images above are just a representation of the package family, actual package may vary.
Refer to the product data sheet for package details.

4224775/A

DGQ0010D

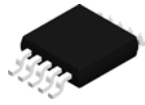

PACKAGE OUTLINE

PowerPAD™ - 1.1 mm max height

PLASTIC SMALL OUTLINE

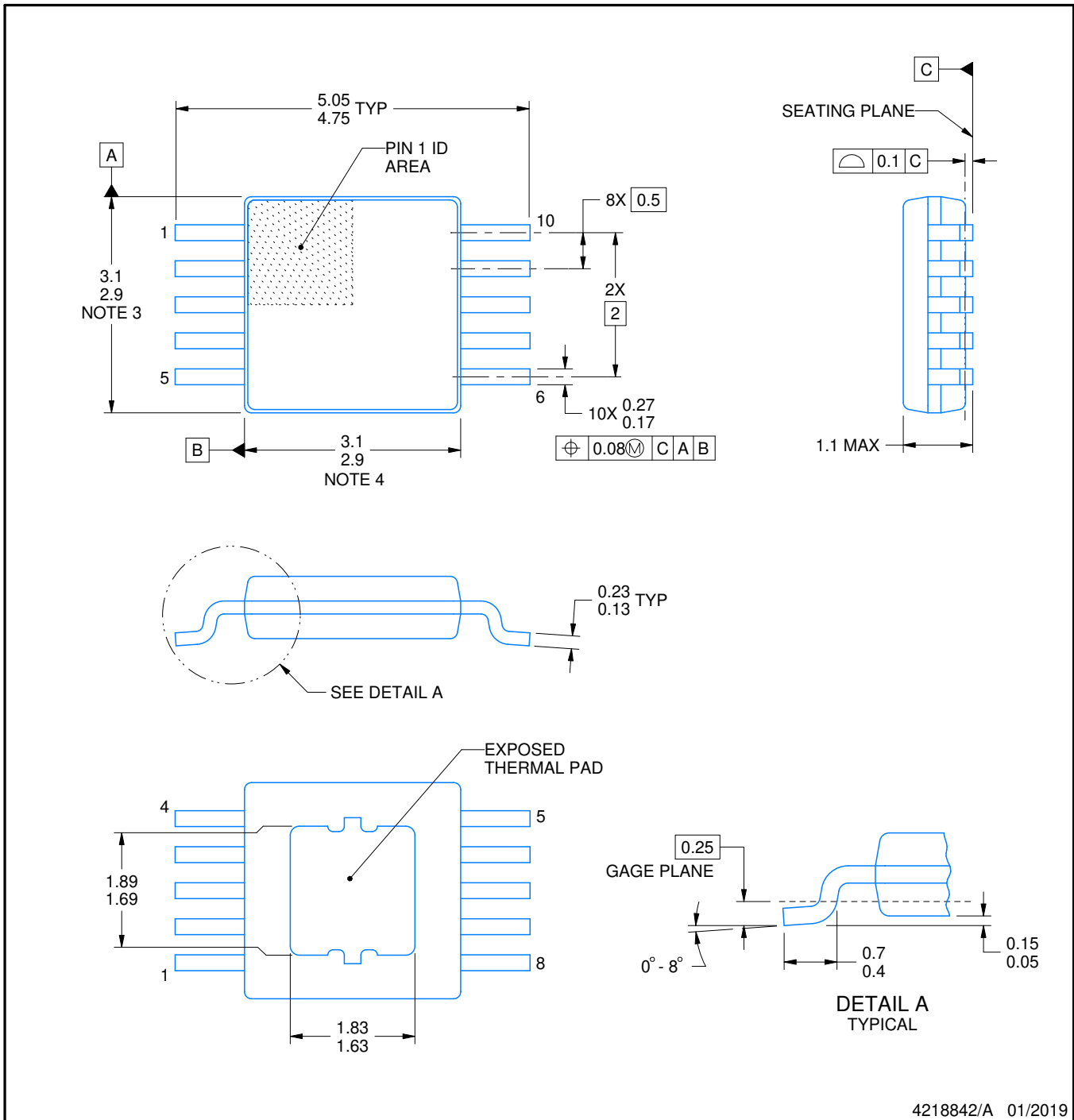

4218842/A 01/2019

PowerPAD is a trademark of Texas Instruments.

NOTES:

1. All linear dimensions are in millimeters. Any dimensions in parenthesis are for reference only. Dimensioning and tolerancing per ASME Y14.5M.
2. This drawing is subject to change without notice.
3. This dimension does not include mold flash, protrusions, or gate burrs. Mold flash, protrusions, or gate burrs shall not exceed 0.15 mm per side.
4. This dimension does not include interlead flash. Interlead flash shall not exceed 0.25 mm per side.
5. Reference JEDEC registration MO-187, variation BA-T.

EXAMPLE BOARD LAYOUT

DGQ0010D

PowerPAD™ - 1.1 mm max height

PLASTIC SMALL OUTLINE

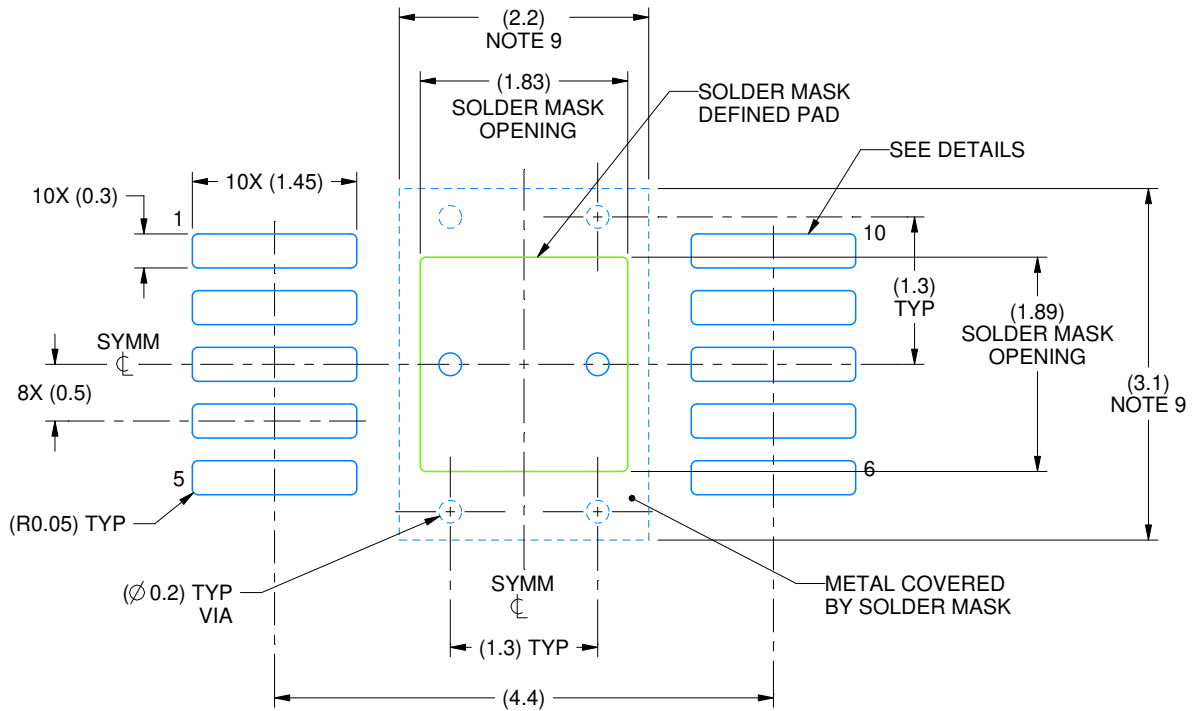

LAND PATTERN EXAMPLE
SCALE:15X

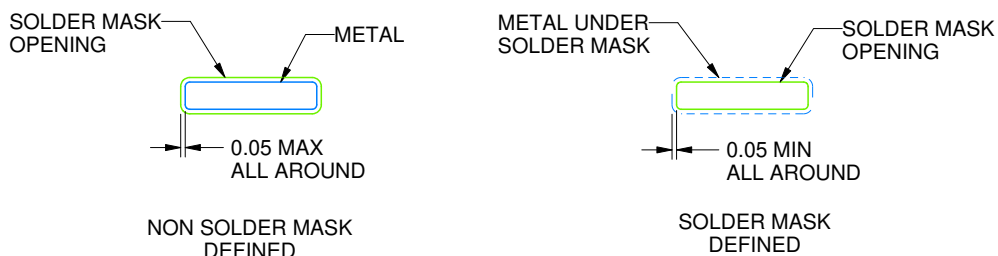

SOLDER MASK DETAILS

4218842/A 01/2019

NOTES: (continued)

6. Publication IPC-7351 may have alternate designs.
7. Solder mask tolerances between and around signal pads can vary based on board fabrication site.
8. This package is designed to be soldered to a thermal pad on the board. For more information, see Texas Instruments literature numbers SLMA002 (www.ti.com/lit/slma002) and SLMA004 (www.ti.com/lit/slma004).
9. Size of metal pad may vary due to creepage requirement.

EXAMPLE STENCIL DESIGN

DGQ0010D

PowerPAD™ - 1.1 mm max height

PLASTIC SMALL OUTLINE

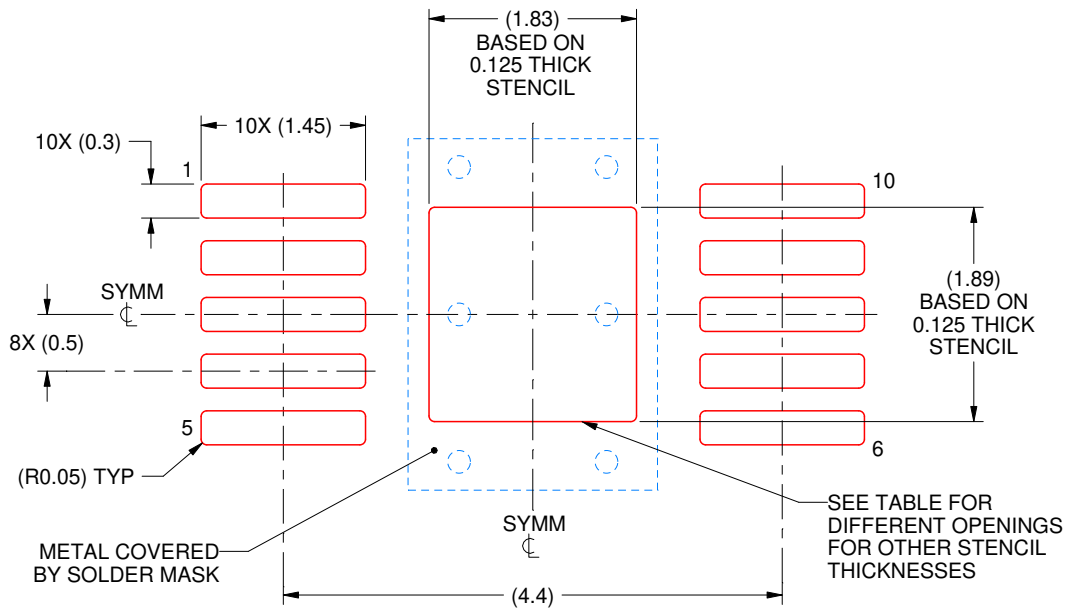

SOLDER PASTE EXAMPLE
EXPOSED PAD
100% PRINTED SOLDER COVERAGE BY AREA
SCALE:15X

STENCIL THICKNESS	SOLDER STENCIL OPENING
0.1	2.05 X 2.11
0.125	1.83 X 1.89 (SHOWN)
0.150	1.67 X 1.73
0.175	1.55 X 1.60

4218842/A 01/2019

NOTES: (continued)

10. Laser cutting apertures with trapezoidal walls and rounded corners may offer better paste release. IPC-7525 may have alternate design recommendations.
11. Board assembly site may have different recommendations for stencil design.

GENERIC PACKAGE VIEW

DGN 8

PowerPAD VSSOP - 1.1 mm max height

3 x 3, 0.65 mm pitch

SMALL OUTLINE PACKAGE

This image is a representation of the package family, actual package may vary.
Refer to the product data sheet for package details.

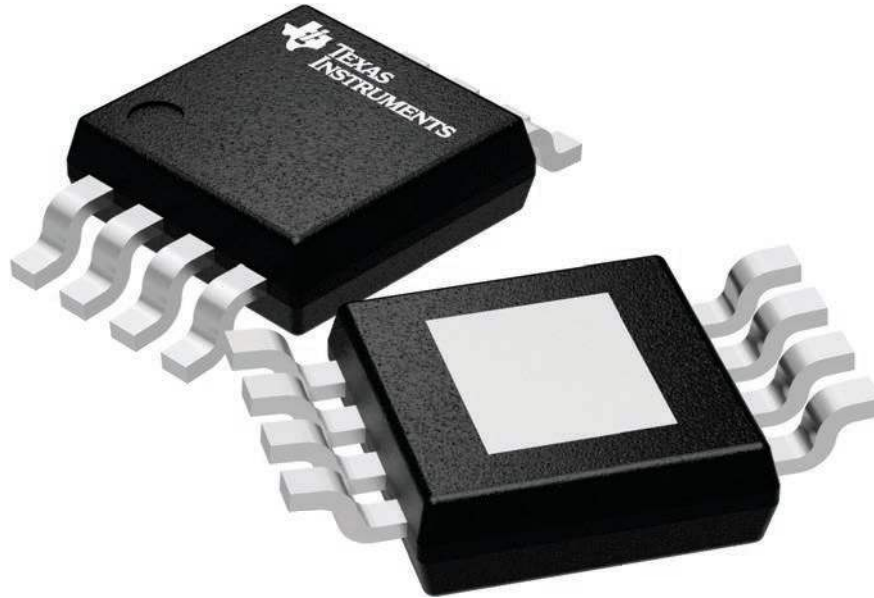

4225482/A

DGN0008D



PACKAGE OUTLINE

PowerPAD™ VSSOP - 1.1 mm max height

SMALL OUTLINE PACKAGE

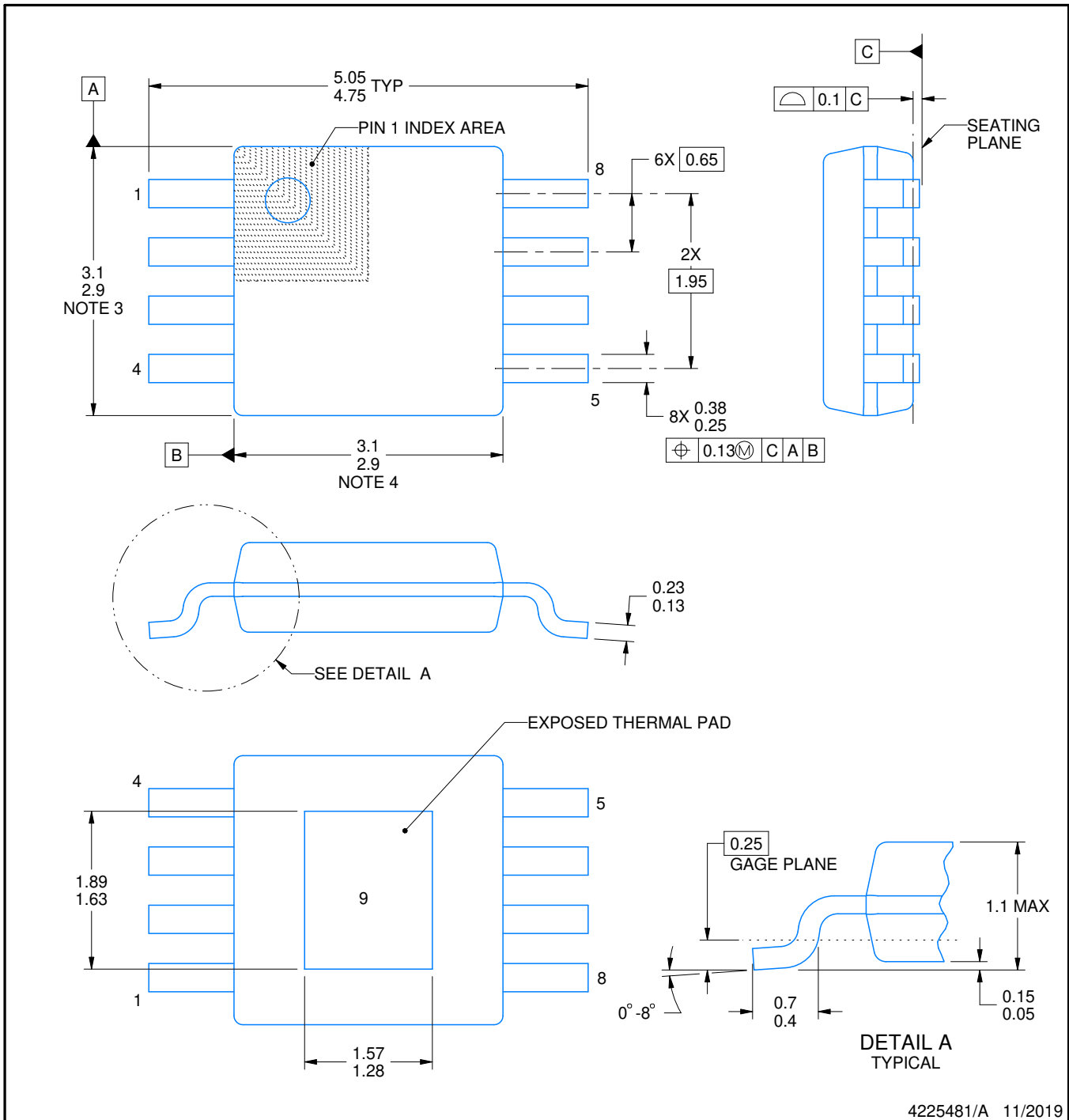

4225481/A 11/2019

NOTES:

PowerPAD is a trademark of Texas Instruments.

1. All linear dimensions are in millimeters. Any dimensions in parenthesis are for reference only. Dimensioning and tolerancing per ASME Y14.5M.
2. This drawing is subject to change without notice.
3. This dimension does not include mold flash, protrusions, or gate burrs. Mold flash, protrusions, or gate burrs shall not exceed 0.15 mm per side.
4. This dimension does not include interlead flash. Interlead flash shall not exceed 0.25 mm per side.
5. Reference JEDEC registration MO-187.

EXAMPLE BOARD LAYOUT

DGN0008D

PowerPAD™ VSSOP - 1.1 mm max height

SMALL OUTLINE PACKAGE

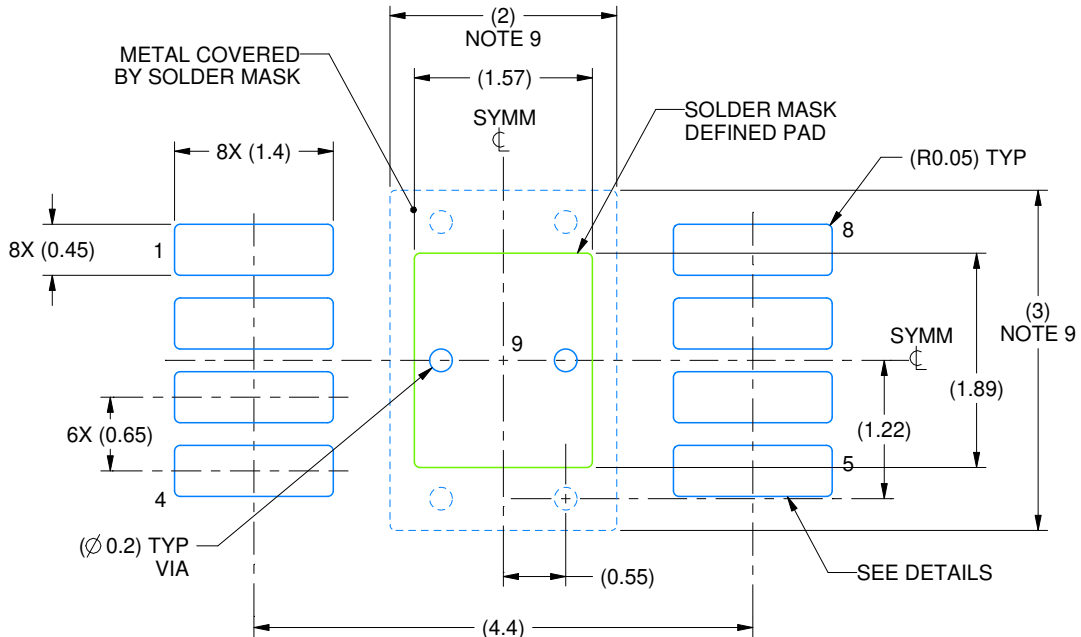

LAND PATTERN EXAMPLE
EXPOSED METAL SHOWN
SCALE: 15X

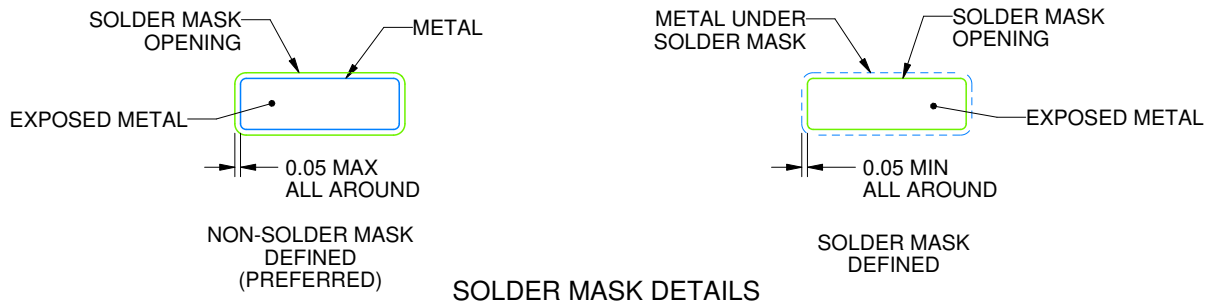

SOLDER MASK DETAILS

4225481/A 11/2019

NOTES: (continued)

6. Publication IPC-7351 may have alternate designs.
7. Solder mask tolerances between and around signal pads can vary based on board fabrication site.
8. Vias are optional depending on application, refer to device data sheet. If any vias are implemented, refer to their locations shown on this view. It is recommended that vias under paste be filled, plugged or tented.
9. Size of metal pad may vary due to creepage requirement.

EXAMPLE STENCIL DESIGN

DGN0008D

PowerPAD™ VSSOP - 1.1 mm max height

SMALL OUTLINE PACKAGE

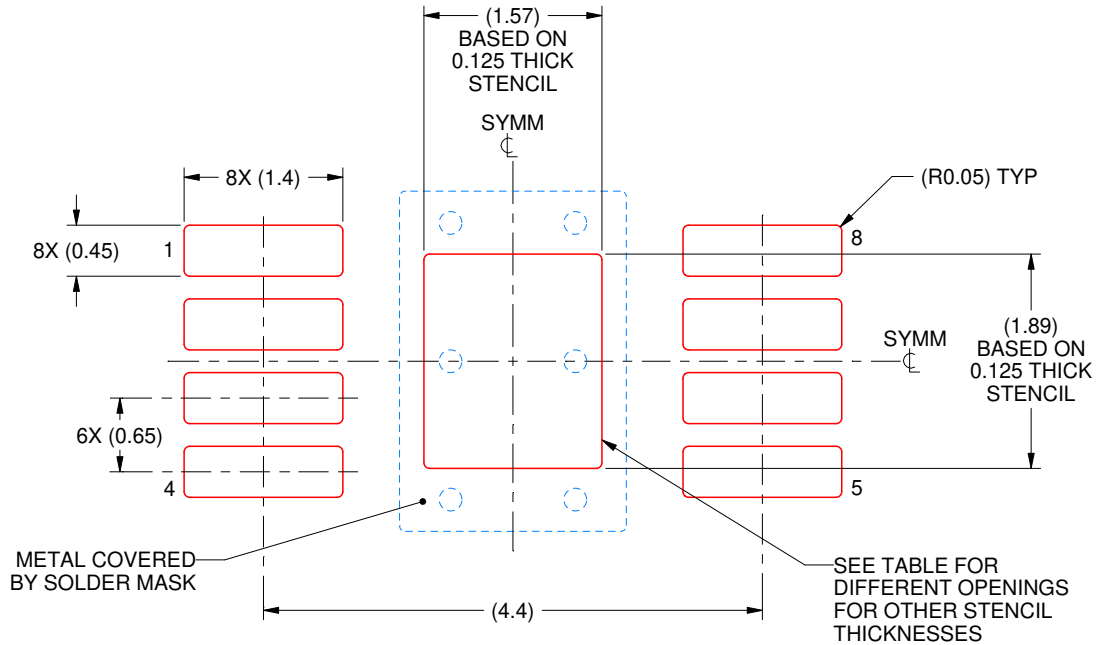

SOLDER PASTE EXAMPLE
EXPOSED PAD 9:
100% PRINTED SOLDER COVERAGE BY AREA
SCALE: 15X

STENCIL THICKNESS	SOLDER STENCIL OPENING
0.1	1.76 X 2.11
0.125	1.57 X 1.89 (SHOWN)
0.15	1.43 X 1.73
0.175	1.33 X 1.60

4225481/A 11/2019

NOTES: (continued)

10. Laser cutting apertures with trapezoidal walls and rounded corners may offer better paste release. IPC-7525 may have alternate design recommendations.
11. Board assembly site may have different recommendations for stencil design.

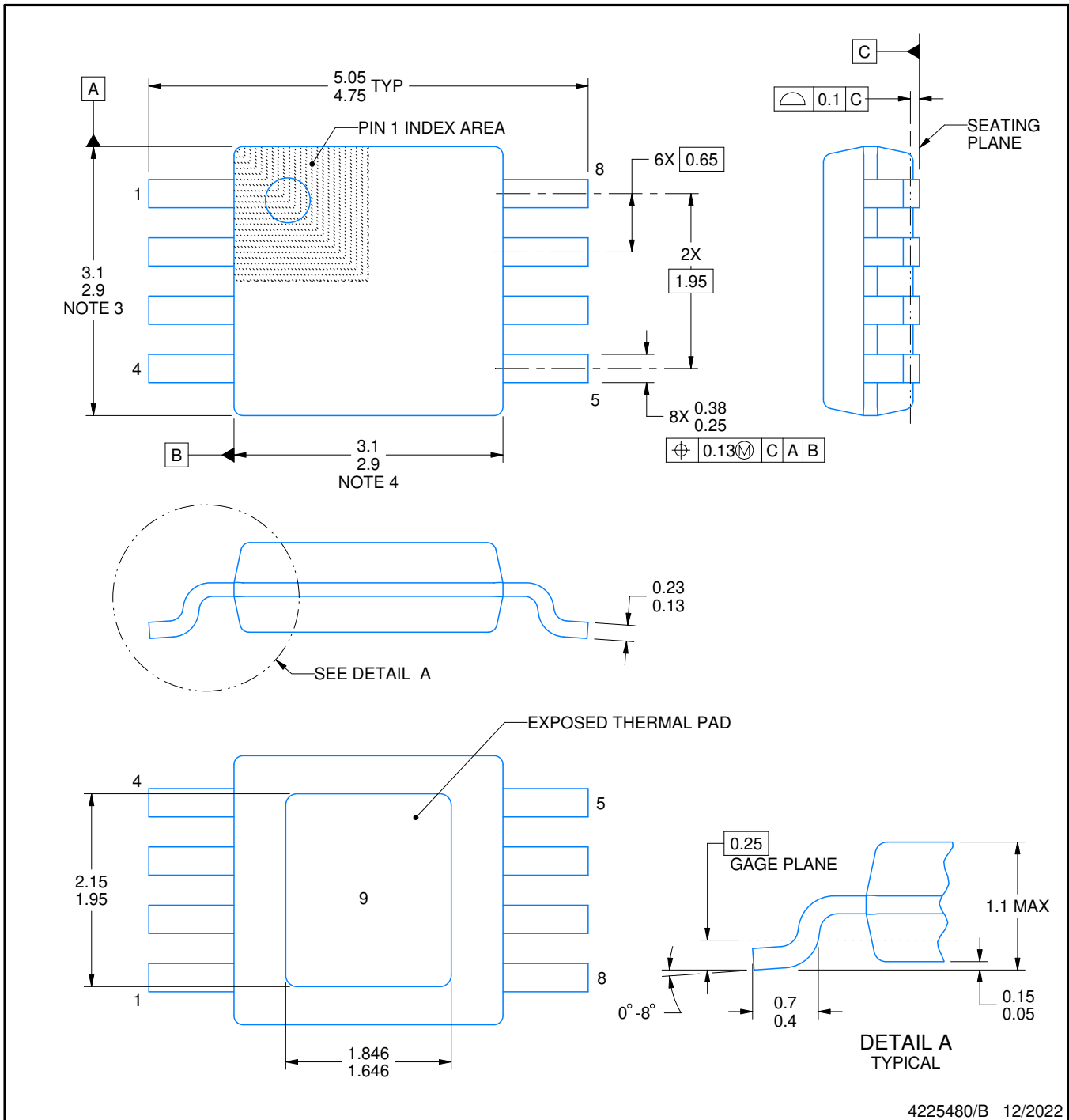
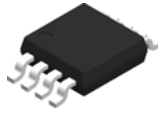

4225480/B 12/2022

PowerPAD is a trademark of Texas Instruments.

NOTES:

1. All linear dimensions are in millimeters. Any dimensions in parenthesis are for reference only. Dimensioning and tolerancing per ASME Y14.5M.
2. This drawing is subject to change without notice.
3. This dimension does not include mold flash, protrusions, or gate burrs. Mold flash, protrusions, or gate burrs shall not exceed 0.15 mm per side.
4. This dimension does not include interlead flash. Interlead flash shall not exceed 0.25 mm per side.
5. Reference JEDEC registration MO-187.

EXAMPLE BOARD LAYOUT

DGN0008G

PowerPAD™ VSSOP - 1.1 mm max height

SMALL OUTLINE PACKAGE

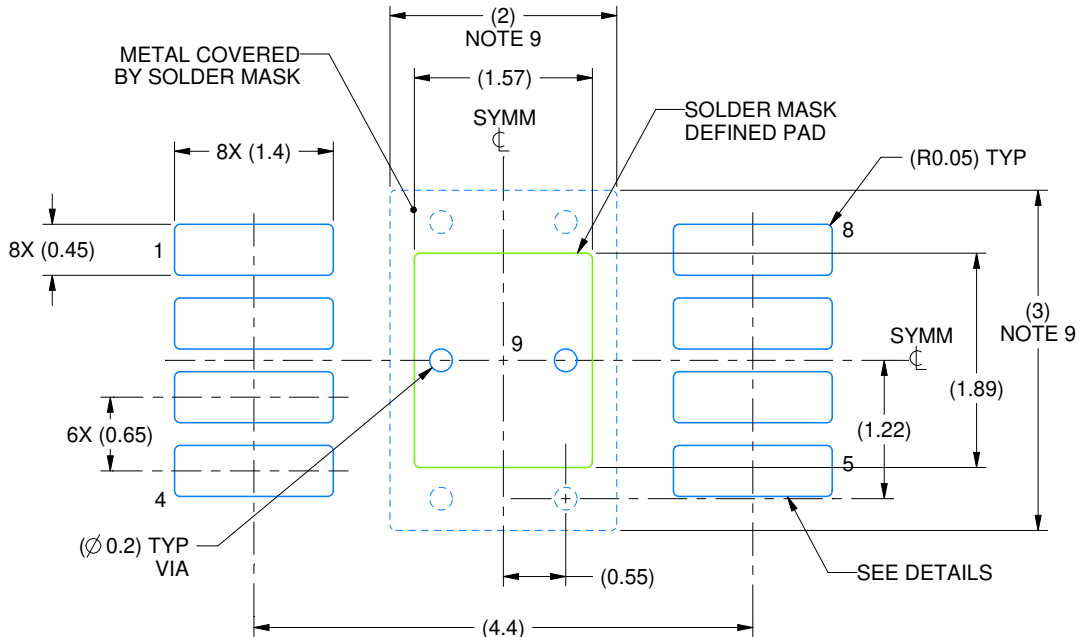

LAND PATTERN EXAMPLE
EXPOSED METAL SHOWN
SCALE: 15X

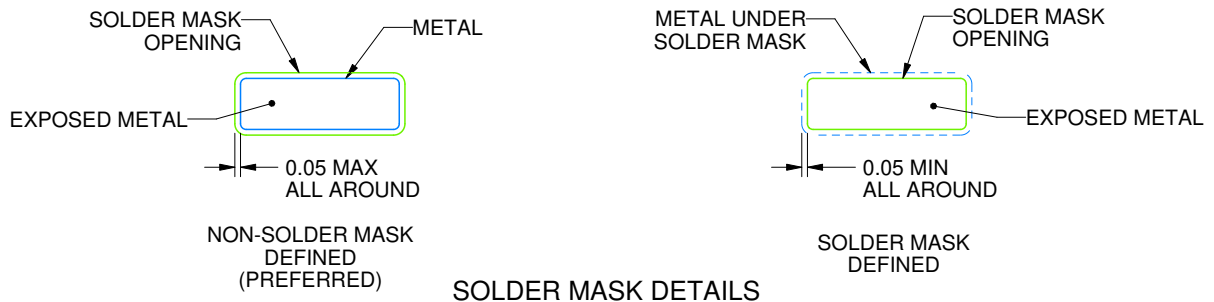

SOLDER MASK DETAILS

4225480/B 12/2022

NOTES: (continued)

- 6. Publication IPC-7351 may have alternate designs.
- 7. Solder mask tolerances between and around signal pads can vary based on board fabrication site.
- 8. Vias are optional depending on application, refer to device data sheet. If any vias are implemented, refer to their locations shown on this view. It is recommended that vias under paste be filled, plugged or tented.
- 9. Size of metal pad may vary due to creepage requirement.

EXAMPLE STENCIL DESIGN

DGN0008G

PowerPAD™ VSSOP - 1.1 mm max height

SMALL OUTLINE PACKAGE

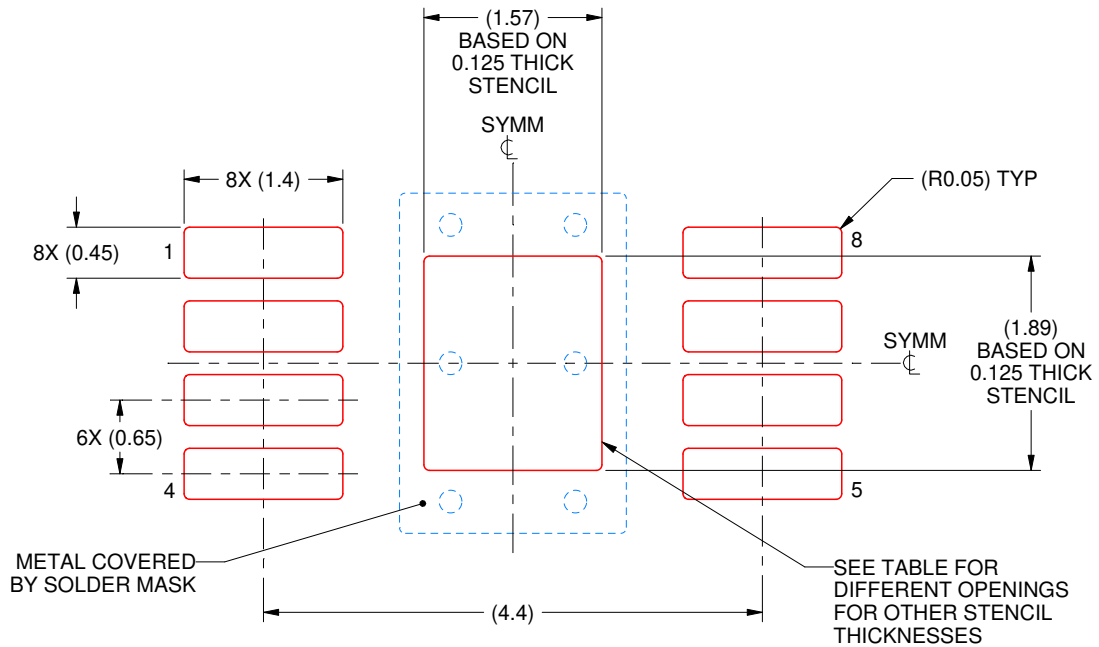

SOLDER PASTE EXAMPLE
EXPOSED PAD 9:
100% PRINTED SOLDER COVERAGE BY AREA
SCALE: 15X

STENCIL THICKNESS	SOLDER STENCIL OPENING
0.1	1.76 X 2.11
0.125	1.57 X 1.89 (SHOWN)
0.15	1.43 X 1.73
0.175	1.33 X 1.60

4225480/B 12/2022



NOTES: (continued)

10. Laser cutting apertures with trapezoidal walls and rounded corners may offer better paste release. IPC-7525 may have alternate design recommendations.
11. Board assembly site may have different recommendations for stencil design.

D (R-PDSO-G14)

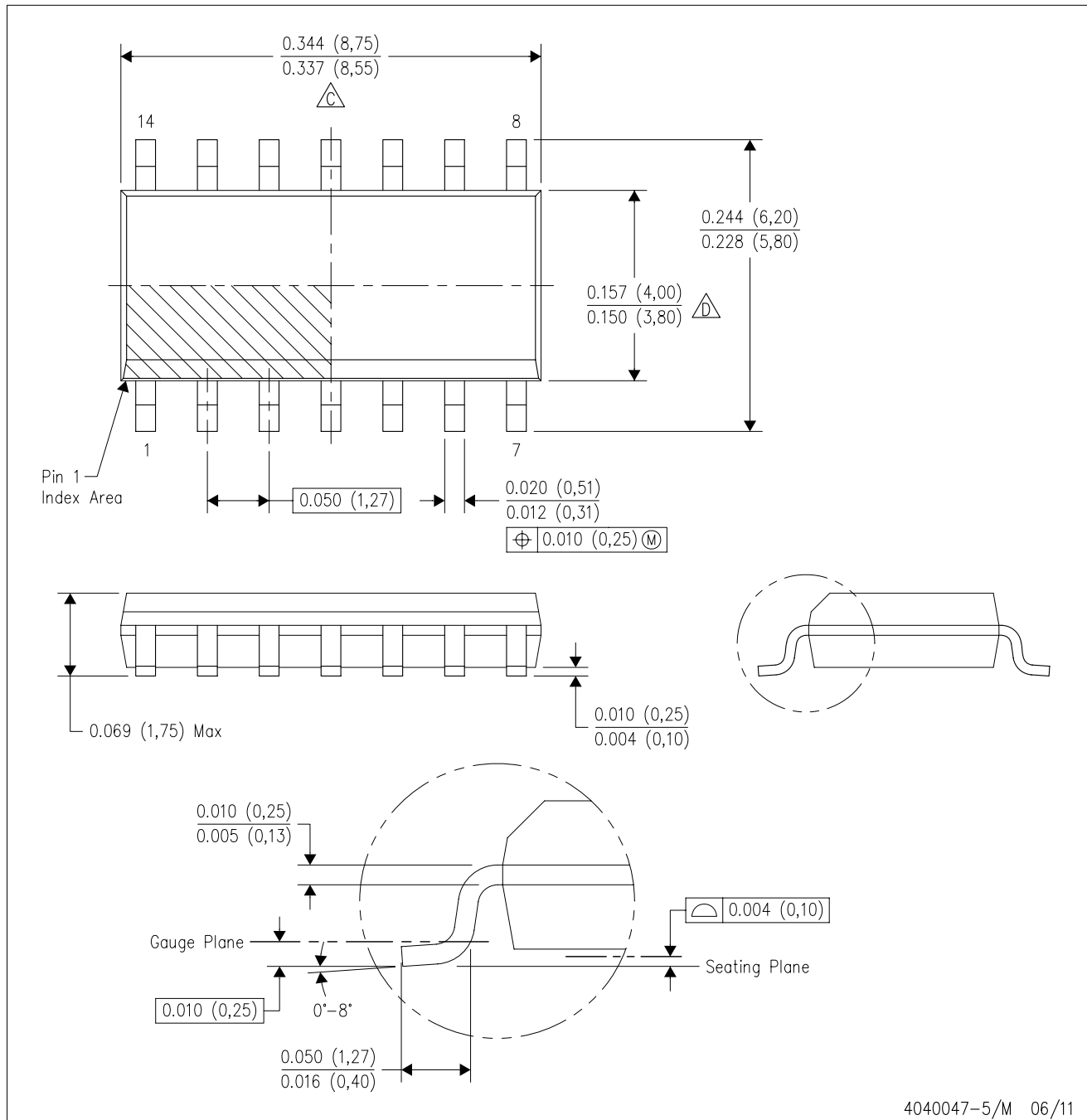
PLASTIC SMALL OUTLINE



- NOTES:
- A. All linear dimensions are in inches (millimeters).
 - B. This drawing is subject to change without notice.
 -  Body length does not include mold flash, protrusions, or gate burrs. Mold flash, protrusions, or gate burrs shall not exceed 0.006 (0,15) each side.
 -  Body width does not include interlead flash. Interlead flash shall not exceed 0.017 (0,43) each side.
 - E. Reference JEDEC MS-012 variation AB.



D0008A

PACKAGE OUTLINE

SOIC - 1.75 mm max height

SMALL OUTLINE INTEGRATED CIRCUIT

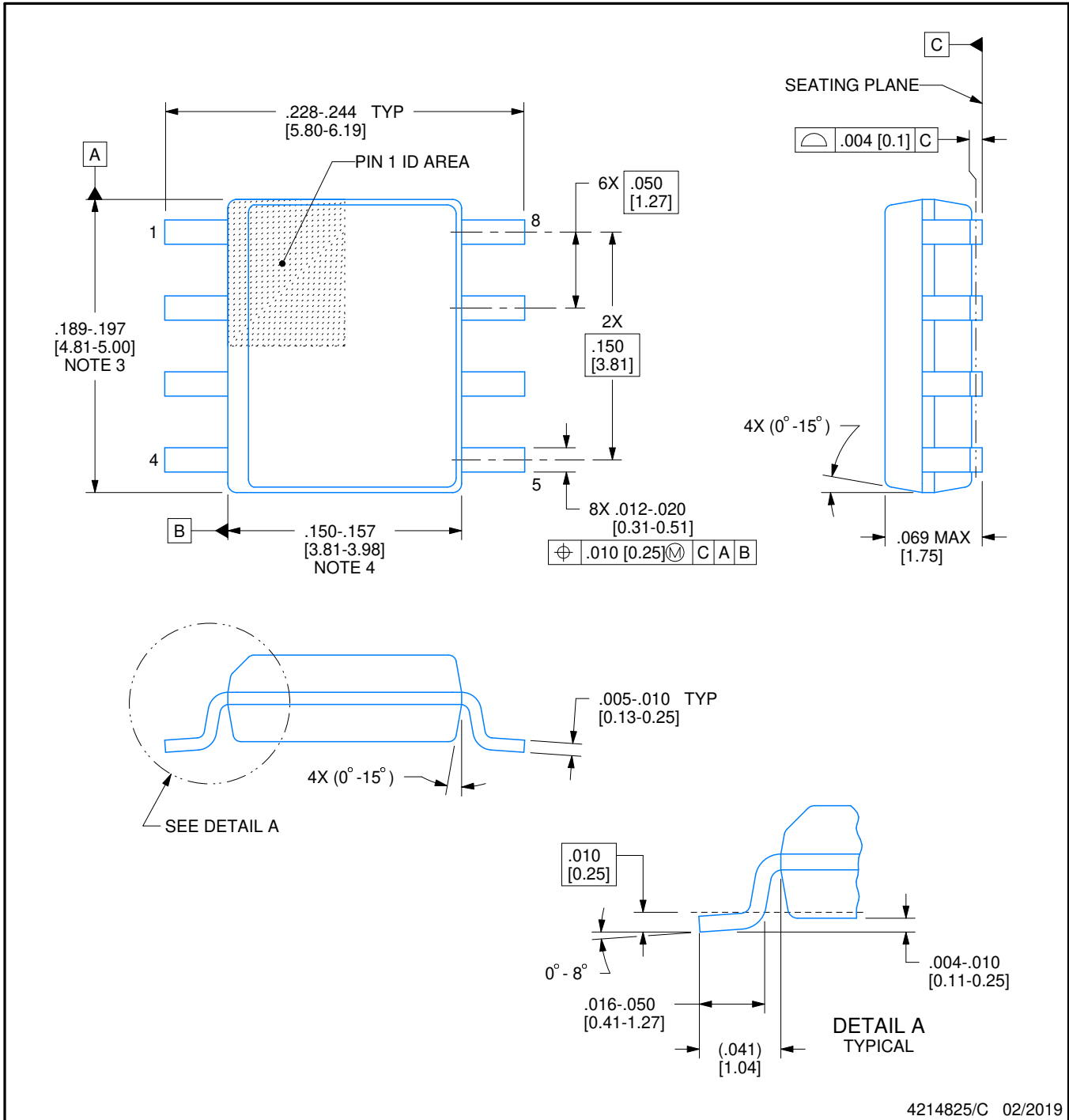

4214825/C 02/2019

NOTES:

1. Linear dimensions are in inches [millimeters]. Dimensions in parenthesis are for reference only. Controlling dimensions are in inches. Dimensioning and tolerancing per ASME Y14.5M.
2. This drawing is subject to change without notice.
3. This dimension does not include mold flash, protrusions, or gate burrs. Mold flash, protrusions, or gate burrs shall not exceed .006 [0.15] per side.
4. This dimension does not include interlead flash.
5. Reference JEDEC registration MS-012, variation AA.

EXAMPLE BOARD LAYOUT

D0008A

SOIC - 1.75 mm max height

SMALL OUTLINE INTEGRATED CIRCUIT



LAND PATTERN EXAMPLE
EXPOSED METAL SHOWN
SCALE:8X



SOLDER MASK DETAILS

4214825/C 02/2019

NOTES: (continued)

- 6. Publication IPC-7351 may have alternate designs.
- 7. Solder mask tolerances between and around signal pads can vary based on board fabrication site.

EXAMPLE STENCIL DESIGN

D0008A

SOIC - 1.75 mm max height

SMALL OUTLINE INTEGRATED CIRCUIT



SOLDER PASTE EXAMPLE
BASED ON .005 INCH [0.125 MM] THICK STENCIL
SCALE:8X

4214825/C 02/2019

NOTES: (continued)

8. Laser cutting apertures with trapezoidal walls and rounded corners may offer better paste release. IPC-7525 may have alternate design recommendations.
9. Board assembly site may have different recommendations for stencil design.

P (R-PDIP-T8)

PLASTIC DUAL-IN-LINE PACKAGE

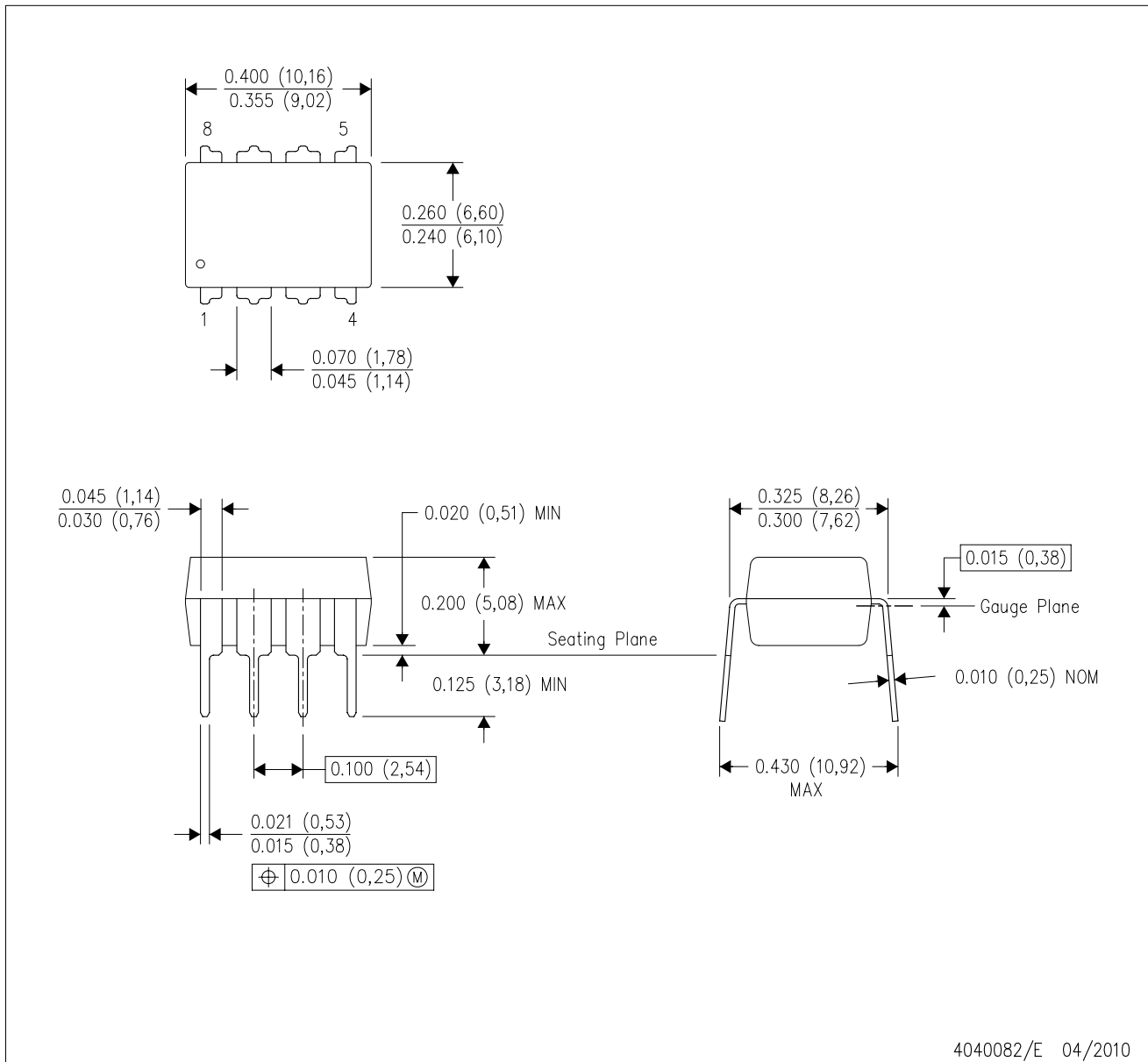

4040082/E 04/2010

- NOTES:
- A. All linear dimensions are in inches (millimeters).
 - B. This drawing is subject to change without notice.
 - C. Falls within JEDEC MS-001 variation BA.

N (R-PDIP-T**)

PLASTIC DUAL-IN-LINE PACKAGE

16 PINS SHOWN



- NOTES:
- A. All linear dimensions are in inches (millimeters).
 - B. This drawing is subject to change without notice.
 - C Falls within JEDEC MS-001, except 18 and 20 pin minimum body length (Dim A).
 - D The 20 pin end lead shoulder width is a vendor option, either half or full width.

4040049/E 12/2002

IMPORTANT NOTICE AND DISCLAIMER

TI PROVIDES TECHNICAL AND RELIABILITY DATA (INCLUDING DATA SHEETS), DESIGN RESOURCES (INCLUDING REFERENCE DESIGNS), APPLICATION OR OTHER DESIGN ADVICE, WEB TOOLS, SAFETY INFORMATION, AND OTHER RESOURCES "AS IS" AND WITH ALL FAULTS, AND DISCLAIMS ALL WARRANTIES, EXPRESS AND IMPLIED, INCLUDING WITHOUT LIMITATION ANY IMPLIED WARRANTIES OF MERCHANTABILITY, FITNESS FOR A PARTICULAR PURPOSE OR NON-INFRINGEMENT OF THIRD PARTY INTELLECTUAL PROPERTY RIGHTS.

These resources are intended for skilled developers designing with TI products. You are solely responsible for (1) selecting the appropriate TI products for your application, (2) designing, validating and testing your application, and (3) ensuring your application meets applicable standards, and any other safety, security, regulatory or other requirements.

These resources are subject to change without notice. TI grants you permission to use these resources only for development of an application that uses the TI products described in the resource. Other reproduction and display of these resources is prohibited. No license is granted to any other TI intellectual property right or to any third party intellectual property right. TI disclaims responsibility for, and you will fully indemnify TI and its representatives against, any claims, damages, costs, losses, and liabilities arising out of your use of these resources.

TI's products are provided subject to [TI's Terms of Sale](#) or other applicable terms available either on [ti.com](https://www.ti.com) or provided in conjunction with such TI products. TI's provision of these resources does not expand or otherwise alter TI's applicable warranties or warranty disclaimers for TI products.

TI objects to and rejects any additional or different terms you may have proposed.

Mailing Address: Texas Instruments, Post Office Box 655303, Dallas, Texas 75265
Copyright © 2023, Texas Instruments Incorporated