



**San Technology, Inc.**

**SPECIFICATION  
FOR  
LCD MODULE**

Customer P/N:  
Santek P/N: ST0500A2WCYOL-RSLW-C  
DOC. Revision: RS02

**Customer Approval:**

--

	SIGNATURE	DATE
PREPARED BY	Vivian Huang	2016.09.08
CHECKED BY	Sam Liu	2016.09.08
APPROVED BY	Natty Lee	2016-Sep-12

Document Revision History

Revision	Date	Description	Changed by
RS01	2016.05.24	FIRST ISSUE	Vivian Huang
RS02	2016.09.08	Add Power Consumption (Page 4) Add Packing drawing (Page 61)	Vivian Huang

Table of Contents

1. General Specifications.....	4
2. Mechanical Units .....	5
3. Input / Output Terminals .....	5
4. CTP Specifications .....	7
5. Mechanical Drawing .....	9
6. Absolute Maximum Ratings.....	10
7. Electrical Characteristics.....	11
8. Timing Characteristics Of Input Signals .....	12
9. Power Sequence .....	19
10. Optical Characteristics.....	56
11. Environmental / Reliability Tests .....	59
12. Packing drawing .....	61
13. Incoming Inspection Standard .....	62
14. Precautions For Use of LCD modules .....	65

## 1. General Specifications

### 1.1 Description

ST0500A2WCYOL-RSLW-C is a one cell CTP product of 5.0" color TFT-LCD(Thin Film Transistor Liquid Crystal Display), which is 9:16 aspect ratio panels for the high end Mobile application.

The 5.0" screen produces a high resolution image that is composed of 921,600(720x1280) pixel elements in a stripe arrangement. The sensor trace of touch sensor is 10x18 and the transmission interface is I2C.

### 1.2 Functions & Features

Table 1. Module Functions and Features

Parameter	Value	Unit
Size	5.0	inch
Resolution	720x3(H) *1280(V)	Pixel
Display Signal Interface	MIPI 4 Lanes	-
Pixel Pitch	0.02875 (W)*0.08625 (H)	mm
NTSC	70%(typ)	-
Pixel Configuration	R.G.B Vertical Stripe	-
Display Mode	TM with Normal Black	-
Cover Lens Surface Treatment	6H	-
Viewing Direction	80/80/80/80	-
Touch Sensor Type	Capacitance	-
Touch Sensor Numbers	10TX+18RX	-
Sensor Pitch	6.28x6.23	mm
Sensor Electrical Interface	I2C	-
Power consumption	1.0 TYP, 1.2 MAX	Watt Note1

Note1: Include TFT panel, backlight and CTP.

### 1.3 Pixel Configuration

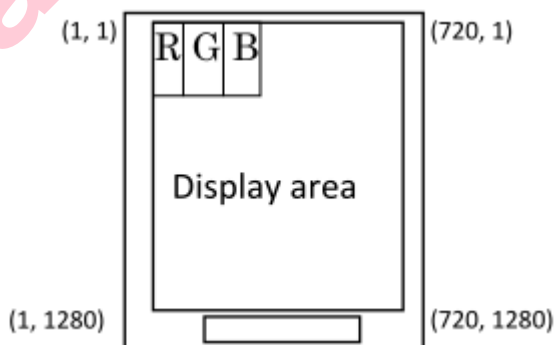

## 2. Mechanical Units

### 2.1 Mechanical Specification

Table 2. Module Mechanical Specification

Parameter	Value	Unit
LCM(WxHxD)	128*70*3.04(Thickness without FPC)	mm
Active Area	62.1(H)*110.4(V)	mm
With/Without CTP	With CTP	-
Weight	TBD	g
LED Numbers	14 LEDs	-
LCD Driver IC	NT35592(w/o RAM)	-
TP Sensor Driver IC	FT5346	-

## 3. Input / Output Terminals

NO	Symbol	I/O/P	Description	Remarks
1	NC		No Connection	
2	GND	P	Ground	
3	LED_AN		LED power	
4	NC(RSVD1)		No Connection (Future Reserved for LED Ground	
5	LED_CA2		LED Cathode 2	
6	LED_CA1		LED Cathode 1	
7	GND	P	Ground	
8	VDDI	P	Power Supply to the I/O (1.8V)	
9	GND	P	Ground	
10	FTE1	O	This signal is used for noise sensing of TP	
11	FTE	O	Frame head pulse signal	
12	LEDPWM	O	This PIN is used to connect to the external LED driver of panel backlight control	
13	RESX	I	Reset signal active low.	
14	GND	P	Ground	
15	D2P	I/O	MIPI-DSI data Lane 2 positive-end I/O	
16	D2N	I/O	MIPI-DSI data Lane 2 negative-end I/O	

17	GND	P	Ground	
18	D1P	I/O	MIPI-DSI data Lane 1 positive-end I/O	
19	D1N	I/O	MIPI-DSI data Lane 1 negative-end I/O	
20	GND	P	Ground	
21	CLKP	I	MIPI clock lane positive end	
22	CLKN	I	MIPI data lane 1 negative end	
23	GND	P	Ground	
24	D0P	I/O	MIPI-DSI data Lane 0 positive-end I/O	
25	D0N	I/O	MIPI-DSI data Lane 0 negative-end I/O	
26	GND	P	Ground	
27	D3P	I/O	MIPI-DSI data Lane 3 positive-end I/O	
28	D3N	I/O	MIPI-DSI data Lane 3 negative-end I/O	
29	GND	P	Ground	
30	VCI		Power supply to the liquid crystal power supply analog circuit ( 3.0V )	
31	NC(RSVD2)		No Connection (Camera Record LED)	
32	NC		No Connection	
33	ALS_INT	I	Ambient Light Sensor Interrupt	
34	GND	P	Ground	
35	NC		No Connection	
36	NC		No Connection	
37	NC		No Connection	
38	NC		No Connection	
39	NC		No Connection	
40	NC		No Connection	

Note: I/O definition: I----Input O----Output P----Power/Ground

## 4. CTP Specification

### 4.1 Construction

Construction	Materials Used	Comment
Glass LENS	Glass	Thickness: 0.55mm
OCA	Adhesive	Thickness: 0.15mm
ITO Sensor	ITO Sensor	Thickness: 0.40 mm

### 4.2 Mechanical Characteristics

Item	Description	Unit
Outside Dimension	128.00*70.00 (±0.1)	mm
View Area	111.10*62.80 (±0.2)	mm
Active Area	112.10*63.80	mm
Thickness	1.10±0.15	mm
Input Method	Finger Or Conductive Pen	
Hardness Of Surface	≥6H	
Accuracy	+/-1mm@10mm	mm
Support Operation	Finger	
Channel	10*18	
Interface	I <sup>2</sup> C	
Supported Operating Systems	Android2.0-5.0Windce	

### 4.3 Electrical Characteristics

Item	Description	Unit
Operating Voltage	DC 3.3 V	V
Insulation Resistance	>20MΩ At DC 25V	MΩ
Insulation Ability	≥60sec. At DC 25V	sec
Chatting Times	<5ms	ms

### 4.4 Optical Characteristics

Item	Description
Total Transmittance	≥85% [JISK7105]
Total Haze	<3% [JISK7105]

### 4.5 Processing Environment

Item	Description
Operating Temperature	-20°C~+70°C
Operating Humidity	≤90%RH
Storage Temperature	-30°C~+80°C
Storage Humidity	<90%RH



## 5. Mechanical Drawing

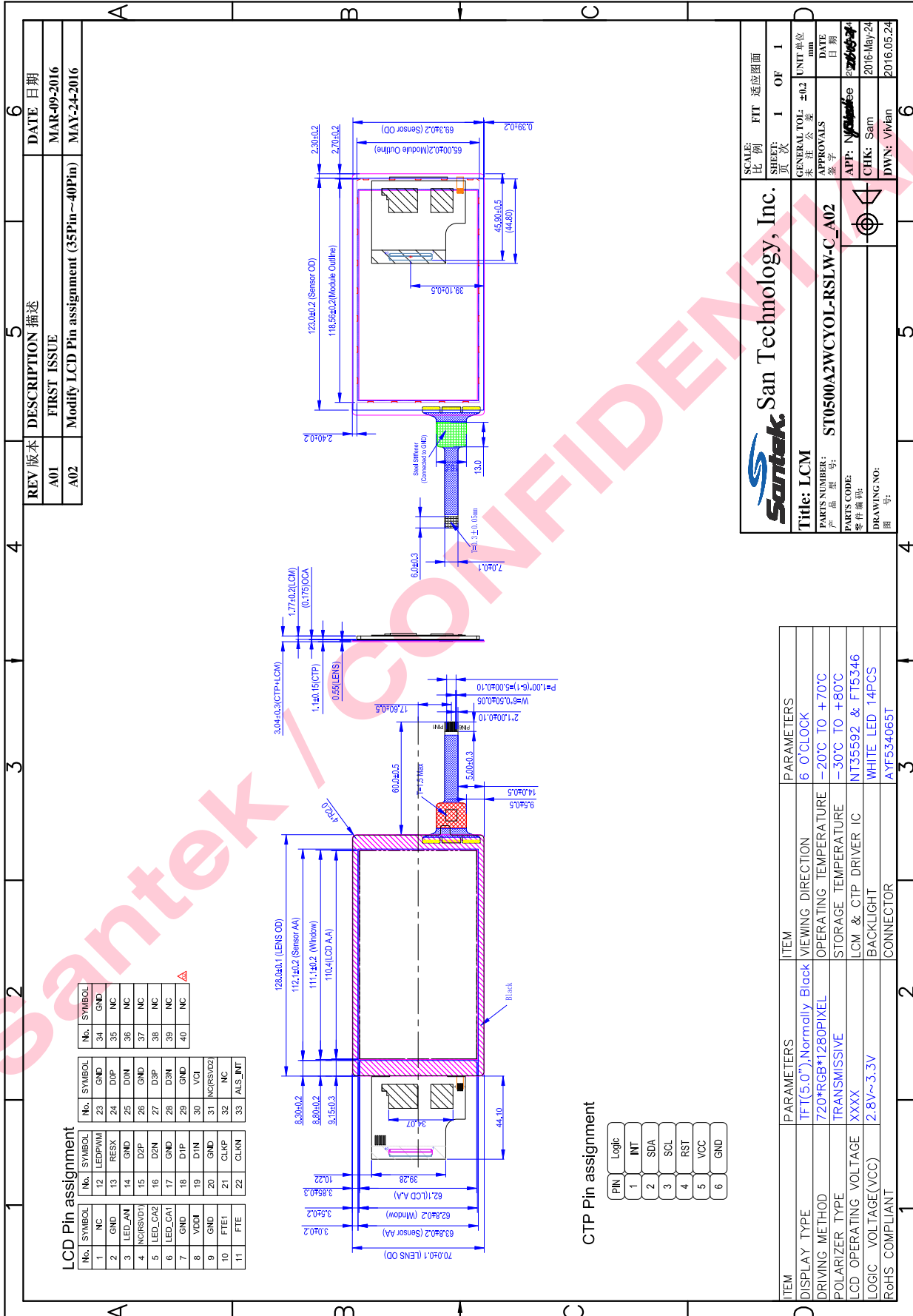

## 6. Absolute Maximum Ratings

Table 6-1

Parameter	Symbol	Rated value	Unit	Note
Driver IC(Digital) Power Supply Voltage	VDDI - GND	0 to +5.5	V	Note6-1
Driver IC(Positive Analog) Power Supply Voltage	AVDD – AGND	0 to +6.5	V	Note6-1
Driver IC(Negative Analog) Power Supply Voltage	AVEE – AGND	-6.5 to 0	V	Note6-1
Driver IC(Analog) Power Supply Voltage	VCI - AGND	0 to +5.5	V	Note6-1
Logic Input voltage range	VIN	0 to +4	V	Note6-1
Logic Output voltage range	VO	-4 to 0	V	Note6-1
Power Supply voltage for MTP programming	MTP_PWR – GND	7.8	V	Note6-1
Temperature for storage	Tstg	-30 to +80	°C	Note6-2
Temperature for operation	Topr	-20 to +70	°C	Note6-2

GND=0V

Note6-1: Voltage applied to GND pins. GND pin conditions are based on all the same voltage (0V).

Always connect all GND externally and use at the same voltage.

Note6-2: Humidity: 95%RHMax.(at Ta≤40°C). Maximum wet-bulb temperature is less than 39°C(at Ta>40°C). Condensation of dew must be avoided.

## 7. Electrical Characteristics

### 7-1. TFT-LCD Panel Driving Section

Table 7-1

GND=0V

Parameter	Symbol	Min.	Typ.	Max.	Unit	Remarks
- 2Power Mode						
DriverIC(Digital) Power Supply Voltage	VDDI	1.75	1.80	1.95	V	Note7-1
Driver IC(Analog) Power Supply Voltage	VCI	2.7	2.8	3.1	V	Note7-1
- 3Power Mode						
DriverIC(Digital) Power Supply Voltage	VDDI	1.75	1.80	1.95	V	Note7-1
Driver IC(Positive Analog) Power Supply Voltage	AVDD	4.9	5.0	5.6	V	Note7-1
Driver IC(Negative Analog) Power Supply Voltage	AVEE	-5.6	-5.0	-4.9	V	Note7-1
Input power for MTP programming	MTP_PWR	7.4	7.5	7.6	V	
Logic Input voltage (High)	V <sub>IH</sub>	0.7VDDI	-	VDDI	V	Note7-2
Logic Input voltage (Low)	V <sub>IL</sub>	0	-	0.3VDDI	V	Note7-2
Logic Output voltage (High)	V <sub>OH</sub>	0.8VDDI	-	-	V	I <sub>OH</sub> =-0.1mA
Logic Output voltage (Low)	V <sub>OL</sub>	0	-	0.2IOVCC	V	I <sub>OL</sub> =+0.1mA
Logic High level leakage (Except MIPI)	ILIH1			1	μA	V <sub>IN</sub> =0 to VDDI
Logic Low Level Leakage (Except MIPI)	ILIL1	-1			μA	V <sub>IN</sub> =0 to VDDI
Logic High level leakage MIPI	ILIH2			10	μA	V <sub>IN</sub> =0 to 1.3V
Logic Low level leakage MIPI	ILIH2	-10			μA	V <sub>IN</sub> =0 to 1.3V
Current consumption	I <sub>VCI</sub>	-	21.5	35	mA	Note7-3
	I <sub>IOVDD1</sub>	-	20	30	mA	Note7-3

Note7-1: Include Ripple Noise

Note7-2: Applied overshoot

Note7-3: Measurement Conditions:

Image Pattern : Full screen white pattern(V255)

Power Supply : VCI=2.8V, IOVCC=1.8V, Ta = 25°C

Video Timing : HS=4,HBP=6,HFP=6,VS=2,VBP=2,VFP=6, Frame refresh ratio 60Hz

MIPI transfer ratio : 472Mbps/lane,

MIPI Data lane number : 4lane

## 8. Timing Characteristics Of Input Signals

### 8-1.MIPI DC Characteristics

<DC characteristics>

Table 8-1

Ta=+25°C, GND=0V

Symbol	Parameter	Min	Typ	Max	Unit
<b>Power and Operation Voltage for MIPI Receiver</b>					
VDDAM	Power supply voltage for MIPI RX	1.7	1.8	4.8	V
VLPH	Low power mode operating voltage	1.1	1.2	1.3	V
<b>MIPI Characteristics for High Speed Receiver</b>					
VILHS	Single-ended input low voltage	-40	-	-	mV
VIHHS	Single-ended input high voltage	-	-	460	mV
VCMRXDC	Common-mode voltage	70	-	330	mV
ZID	Differential input impedance	80	100	125	ohm
VOD	HS transmit differential voltage ( VOD=VDP-VDN)	140	200	250	mV
<b>MIPI Characteristics for Low Power Mode</b>					
VI	Pad signal voltage range	-50	-	1350	mV
VGNDSH	Ground shift	-50	-	50	mV
VIL	Logic 0 input threshold	0	-	550	mV
VIH	Logic 1 input threshold	880	-	VDDAM	mV
VHYST	Input hysteresis	25	-	-	mV
VOL	Output low level	-50	-	50	mV
VOH	Output high level	1.1	1.2	1.3	V
ZOLP	Output impedance of Low Power Transmitter	80	100	125	ohm
VIHCD_MAX	Logic 0 contention threshold	0	-	200	mV
VILCD_MIN	Logic 1 contention threshold	450	-	VDDAM	mV

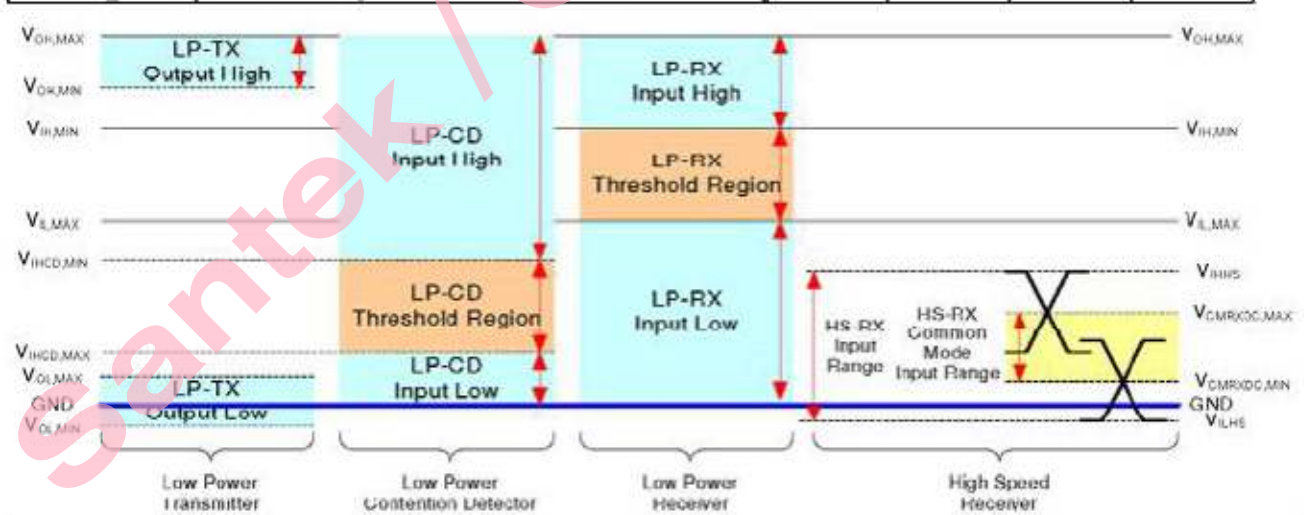

Fig. 8-1

8-2 AC Characteristics

8-2-1 High-Speed Data Transmission : Data-Clock Timing

Table 8-2-1

Ta=+25°C,GND=0V

Parameter	Symbol	Min	Typ	Max	Unit	Remarks
UI instantaneous	UI <sub>INST</sub>	1.176	-	12.5	ns	1,2,5
Data to Clock Skew [measured at transmitter]	T <sub>SKEW[TX]</sub>	-0.15	-	0.15	UI <sub>INST</sub>	3
Data to Clock Setup Time [measured at receiver]	T <sub>SETUP[RX]</sub>	0.15			UI <sub>INST</sub>	4
Data to Clock Hold Time [measured at receiver]	T <sub>HOLD[RX]</sub>	0.15			UI <sub>INST</sub>	4
20% - 80% rise time and fall time	Tr/Tf	150	-	-	ps	
		-	-	0.3	UI <sub>INST</sub>	

(Note1) This value corresponds to minimum 80Mbps data rate.

(Note2) The minimum UI shall not violated for any single bit period.

(Note3) Total delay budget of 0.3 UI<sub>INST</sub>.

(Note4) Total setup and hold window for receiver of 0.3 UI<sub>INST</sub>.

(Note5) For MIPI Speed Limitation:

[1] Per lane bandwidth is 850Mbps,

[2] Total Bit Rate : 2Gbps for 8-8-8; 1.5Gbps for 6-6-6; 1.3Gbps for 5-6-5

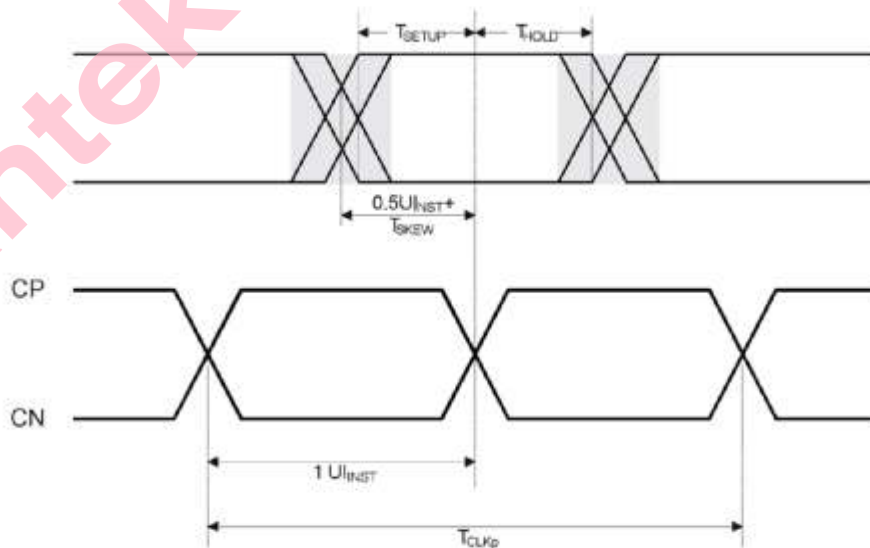

8-2-2 LP Transmission AC Specification

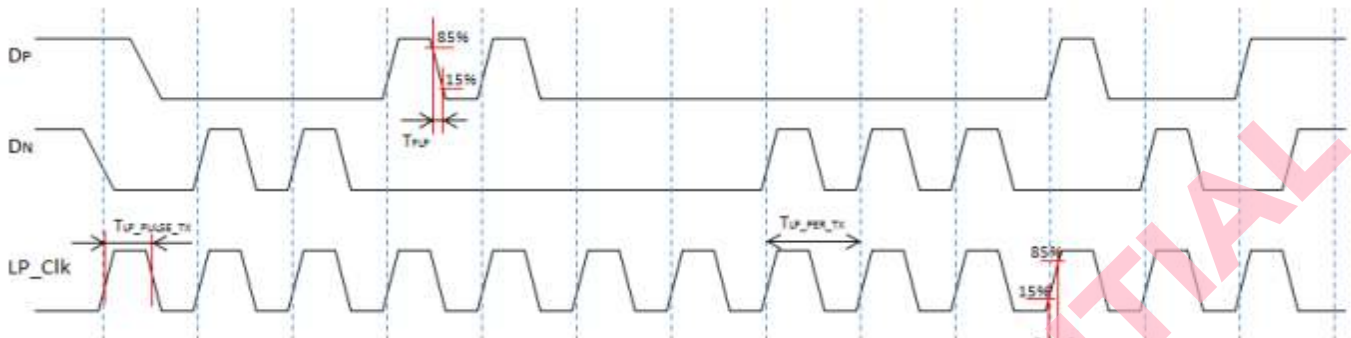

Table 8-2-2

Parameter	Symbol	Min	Typ	Max	Unit	Remarks
15%-85% rise time and fall time	$T_{RLP} / T_{FLP}$	-	-	25	ns	1
30%-85% rise time and fall time	$T_{REO}$	-	-	35	ns	1,5,6
Pulse width of the LP exclusive-OR clock	First LP exclusive-OR clock pulse after STOP state or last pulse before stop state	40	-	-	ns	4
	All other pulses	20	--	-	ns	4
Period of the LP exclusive-OR clock	$T_{LP-PER-TX}$	90	-	-	Ns	
Slew Rate@ $C_{LOAD} = 0pF$	$\delta V / \delta t_{SR}$	30	-	500	mV/ns	1,2,3,7
Slew Rate@ $C_{LOAD} = 5pF$	$\delta V / \delta t_{SR}$	30	-	200	mV/ns	1,2,3,7
Slew Rate@ $C_{LOAD} = 20pF$	$\delta V / \delta t_{SR}$	30	-	150	mV/ns	1,2,3,7
Slow Rate@ $C_{LOAD} = 70pF$	$\delta V / \delta t_{SR}$	30	-	100	mV/ns	1,2,3,7
Load Capacitance	$C_{LOAD}$	-	-	70	pF	1

(Note1) CLOAD includes the low-frequency equivalent transmission line capacitance. The capacitance of TX and RX are assumed to always be <10pF. The distributed line capacitance can be up to 50pF for a transmission line with 2ns delay.

(Note2) When the output voltage is between 15% and below 85% of the fully settled LP signal levels.

(Note3) Measured as average across any 50mV segment of the output signal transition.

(Note4) This parameter value can be lower than TLPX due to differences in rise vs. fall signal slopes and trip levels and mismatches between Dp and Dn Lp transmitters. Any Lp exclusive-OR pulse observed during HS EoT (transition from HS level LP-11) is glitch behavior.

(Note5) The rise-time of TREOT strts from the HS common-level at the moment the differential amplitude drops below 70mV, due to stopping the differential drive.

(Note6) With an additional load capacitance CCM between 0-60pF on the terminationcenter tap at RX side of the Lane.

(Note7) This value represents a corner point in a piecewise linear curve as bellowed.

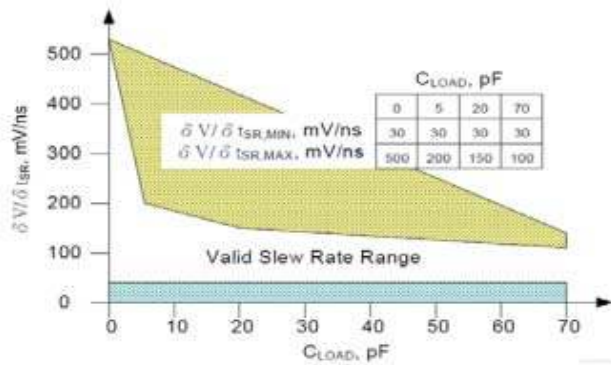

8-2-3 High-Speed Data Transmission In Bursts

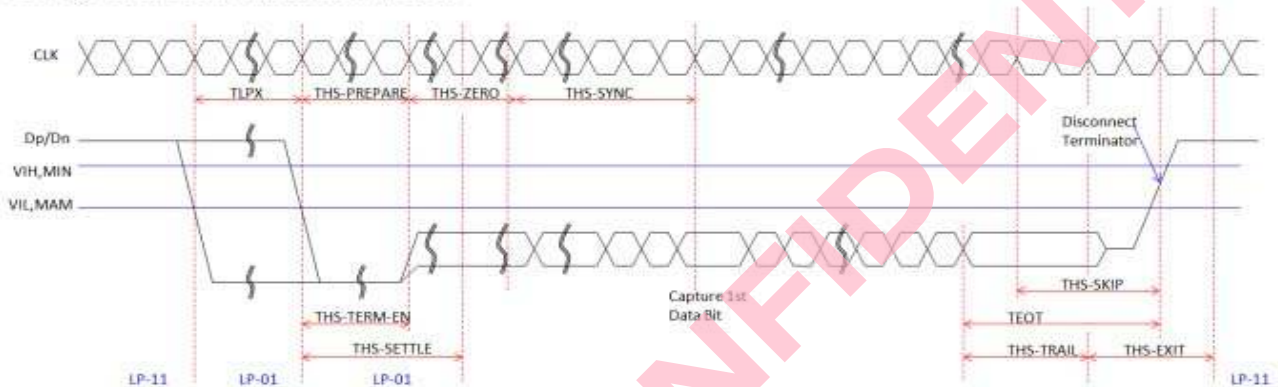

Table 8-2-3

Parameter	Symbol	Min	Typ	Max	Unit
Time to drive LP-00 to prepare for HS transmission	$T_{HS-PREPARE}$	40+4UI	-	85+6UI	ns
Time from start of tHS-TRAIL or tCLK-TRAIL period to start of LP-11 state	$T_{EOT}$	-	-	105+12UI	ns
Time to enable Data Lane receiver line termination measured from when Dn cross VIL,MAX	$T_{HS-TERM-EN}$	-	-	35+4UI	ns
Time to drive flipped differential state after last payload data bit of a HS transmission burst	$T_{HS-TRAIL}$	60+4UI	-	-	ns
Time-out at RX to ignore transition period of EoT	$T_{HS-SKIP}$	40	-	55+4UI	ns
Time to drive LP-11 after HS burst	$T_{HS-EXIT}$	100	-	-	ns
Length of any Low-Power state period	$T_{LPX}$	50	-	-	ns
Sync sequence period	$T_{HS-SYNC}$	-	8UI	-	ns
Minimum lead HS-0 drive period before the Sync sequence	$T_{HS-ZERO}$	105+6UI	-	-	ns

(Note1) The minimum value depends on the bit rate. Implementations should ensure proper operation for all the supported bit rates.

(Note2) UI means Unit Interval, equal to one half HS the clock period on the Clock lane.

(Note3) TLPX is an internal state machine timing reference. Externally measured values may differ slightly from the specified values due to asymmetrical rise and fall times.

8-2-4 Turnaround Procedure

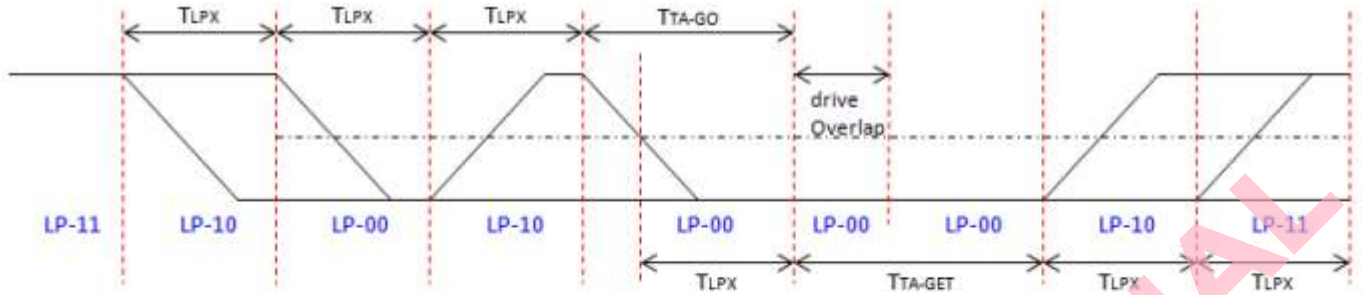

Table 8-2-4

Parameter	Symbol	Min	Typ	Max	Unit
Length of any Low-Power state period : Master side	$T_{LPX}$	50	-	75	ns
Length of any Low-Power state period : Slave side	$T_{LPX}$	50	-	75	ns
Ratio of TLPX(MASTER)/TLPX(SLAVE) between Master and Slave side	Ratio $T_{LPX}$	2/3	-	3/2	-
Time-out before new TX side start driving	$T_{TA-SURE}$	$T_{LPX}$	-	$2T_{LPX}$	ns
Time to drive LP-00 by new Tx	$T_{TA-GET}$	-	$5T_{LPX}$	-	ns
Time to drive LP-00 after turnaround Request	$T_{TA-GO}$	-	$4T_{LPX}$	-	ns



8-2-5 Switching the Clock Lane between Clock Transmission and Low-Power Mode

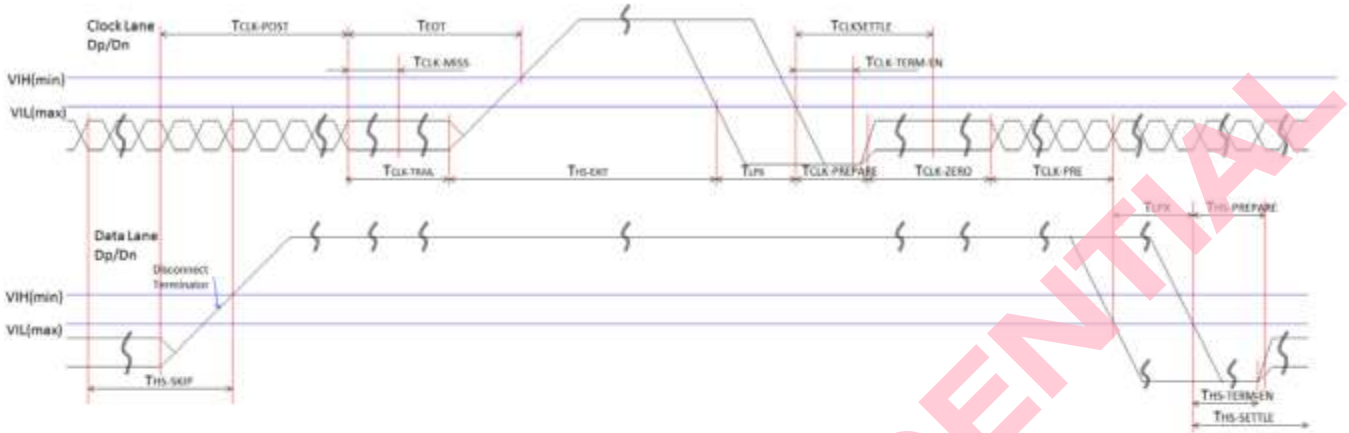

Table 8-2-5

Parameter	Symbol	Min	Typ	Max	Unit
Time that the transmitter shall continue sending HS clock after the last associated Data Lane has transitioned to LP mode	$T_{CLK-POST}$	60+152UI	-	-	ns
Detection time that the clock has stopped toggling	$T_{CLK-MISS}$	-	-	60	ns
Time to drive LP-00 to prepare for HS clock transmission	$T_{CLK-PREPARE}$	38	-	95	ns
Minimum lead HS-0 drive period before starting Clock	$T_{CLK-PREPARE}+T_{CLK-ZERO}$	300	-	-	ns
Time to enable Clock Lane receiver line termination measured from when Dn cross VIL,MAX	$T_{HS-TERM-EN}$	-	-	38	ns
Minimum time that the HS clock must be set prior to any associated data lane beginning the transmission from LP to HS mode	$T_{CLK-PRE}$	8	-	-	UI
Time to drive HS differential state after last payload clock bit of a HS transmission burst	$T_{CLK-TRAIL}$	60	-	-	ns

8-3.Reset Timing Characteristics

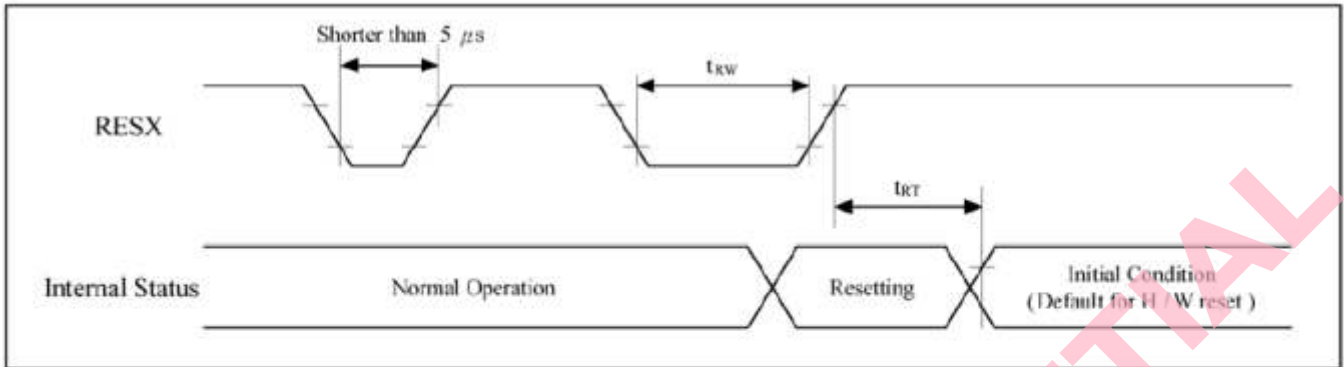

Table 8-3

Ta=-10 to 60°C, VDDI =1.75 to 1.95V, VSP=5.4V, VSN=-5.4V, GND=0V

Signal	Symbol	Parameter	Min.	Max.	Unit
RESX	$t_{rw}$	Reset pulse duration	10(Note)	-	μs
	$t_{rc}$	Reset cancel	-	10(Note)	ms
			-	120(Note)	ms

Note :

- The reset cancel also includes required time for loading ID bytes, VCOM setting and other settings from EEPROM (or similar device) to registers. This loading is done every time when there is HW reset cancel time ( $t_{rc}$ ) within 5 ms after a rising edge of RESX.
- Spike due to an electrostatic discharge on RESX line does not cause irregular system reset according to the table below :

RESX	Pulse Action
Shorter than 5μs	Reset Rejected
Longer than 9μs	Reset
Between 5μs and 9μs	Reset Starts

- During the Resetting period, the display will be blanked(The display is entering blanking sequence, which maximum time is 120 ms, when Reset Starts in Sleep-Out mode. The display remains the blank state in Sleep-In mode). Then return to Default condition for Hardware Reset.
- Spike Rejection also applies during a valid reset pulse as shown below :

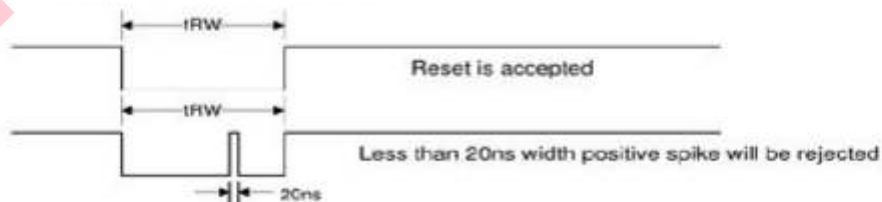

- When Reset applied during Sleep-In Mode.
- When Reset applied during Sleep-Out Mode.
- It is necessary to wait 5ms after releasing RESX before sending commands. Also Sleep Out command cannot be sent for 120 ms.

## 9. Power Sequence

### 9-1 Video Timing

Table 9-1

Contents	Symbol	Condition	Min	Typ	Max	Unit
HS cycle	HP	HDISP+HBLK		736		PCLK
horizontal period	-		12.54	12.9	13.3	us
HS low Pulse width	HS			4		PCLK
Horizontal back porch	HBP			6		PCLK
Horizontal front porch	HFP			6		PCLK
Horizontal data start point		HS+HBP		10		PCLK
Horizontal blanking period	HBLK	HS+HBP+HFP		16		PCLK
Horizontal active area	HDISP			720		PCLK
Pixel clock frequency	PCLK		55.3	57.0	58.7	MHz
Verticle cycle	VP	VDISP+VBLK		1290		Lines
Verticle low pulse width	VS			2		Lines
Vertical front porch	VFP			6		Lines
Vertical back porch	VBP			2		Lines
Vertical data start point		VS+VBP		4		Lines
Vertical blanking period	VBLK	VS+VBP+VFP		10		Lines
Vertical active area	VDISP			1280		Lines
Vertical Refresh rate	VRR		58.2	60	61.8	Hz
<b>MIPI Data transfer ratio (4lane)</b>	-	-	424	472	TBD	Mbps/lane
<b>MIPI Data transfer ratio (3lane)</b>	-	-	528	576	TBD	Mbps/lane

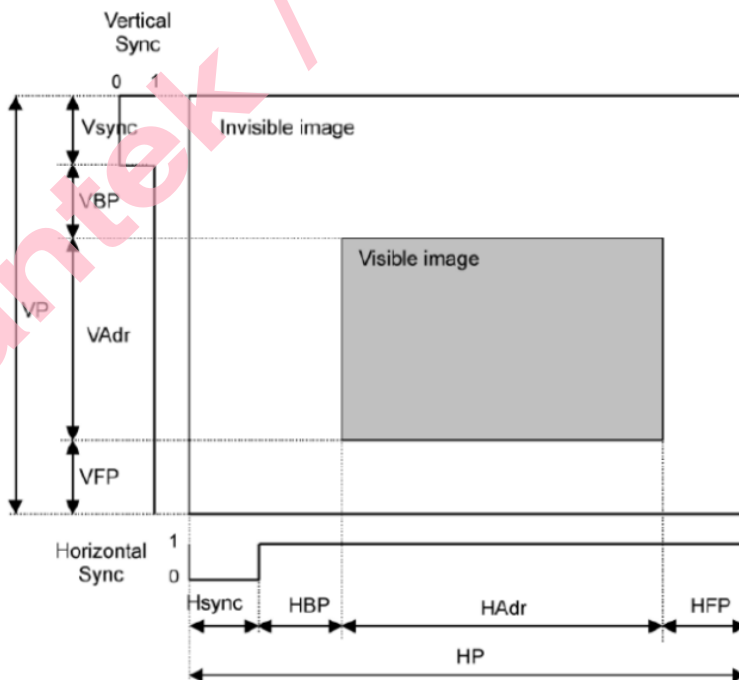

9-2 Power Supply On/Off Setting Sequence

9-2-1 2-input Power (VDDI/VCI)

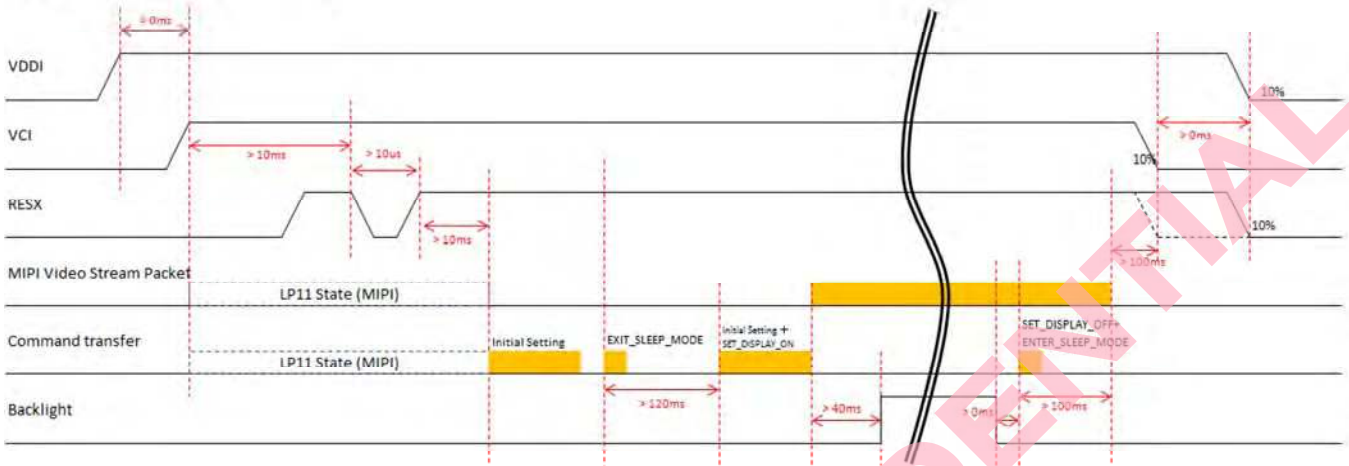

9-2-2 3-Input Power (VDDI/AVDD/AVEE)

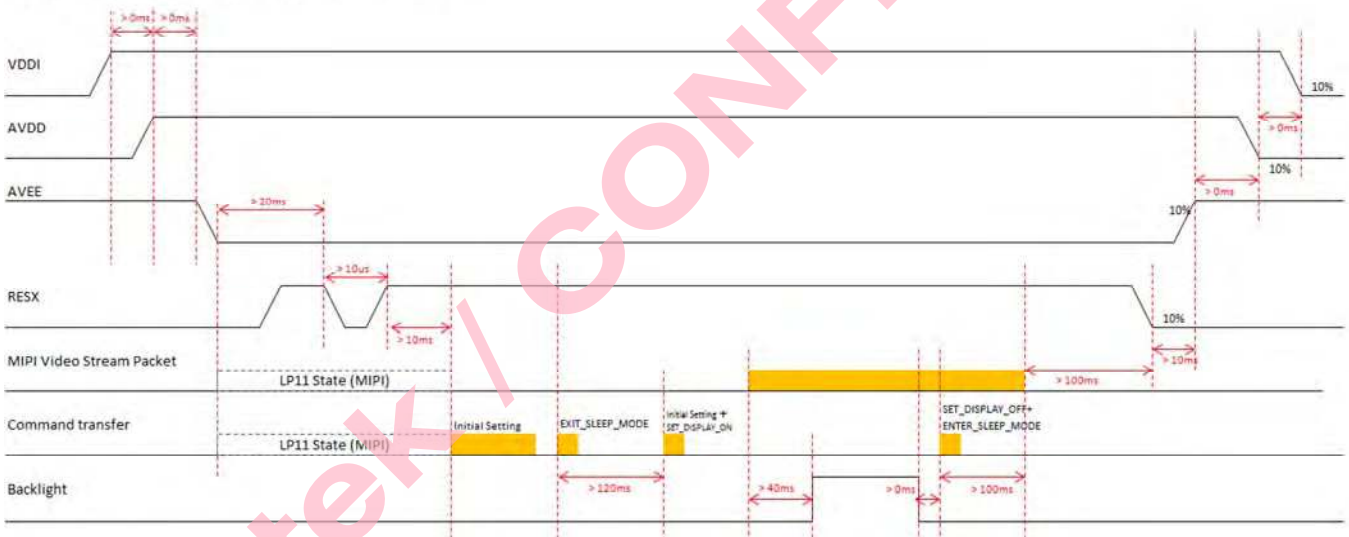

9-3 Power On/Off Sequence

The power supply On/Off setting for No Power, Display On/Off, and Sleep mode Set/Exit sequence is illustrated in figure below.

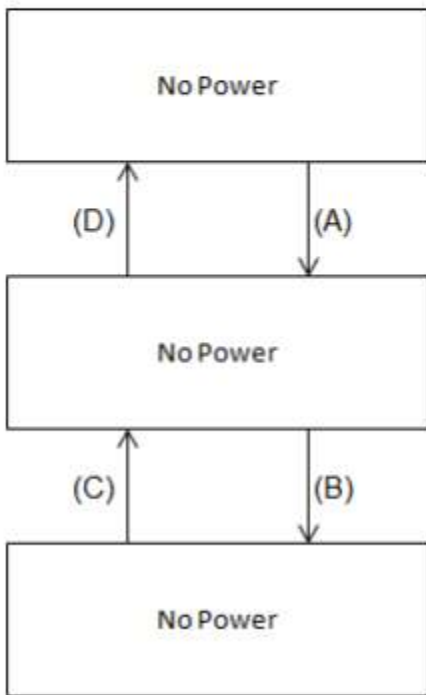

Santek / CONFIDENTIAL

9-3-1 2-Power (VDDI/VCI) Mode

- (A) No Power

Item	Address	Parameter	Delay	MIPI State	Data ID	Comment
<b>&lt;&lt; No Power &gt;&gt;</b>						
↓						
- Initial Condition	RESX = 'Low'			LP00 State		
- Power Supply VDDI	VDDI On			↓		Logic Power (Typ.1.8V)
- Wait	-		Min. 0ms	↓		Wait until Power stable
- Power Supply VCI	VCI On			LP11 State		Analog(Posi) Power (Typ.2.8V)
- Wait	-		Min. 20ms	↓		Wait until Power Stable
- Reset Release	RESX = 'High'			↓		
- Wait	-		Min. 1ms	↓		
- Reset Active	RESX = 'Low'			↓		
- Wait	-		Min. 10us	↓		
- Reset Release	RESX = 'High'			↓		
- Wait	-		Min. 20ms	LP11 State		
↓						
<b>&lt;&lt; Sleep In &gt;&gt;</b>						

- (B) Sleep Out

Item	Address	Parameter	Delay	MIPI State	Data ID	Comment
<b>&lt;&lt; Sleep In &gt;&gt;</b>						
↓						
<i>--- Initial Sequence for MIPI Data lane number selection</i>				LP State		Note : Required only for the sample of MTP Non-programming - Refer to "9-3-3 MIPI Data lane number selection"
<i>--- Initial Sequence for 3Power Mode</i>				HS State		Note : Required only for the sample of MTP Non-programming - Refer to "9-3-4 Initial Sequence "
- Host Display Data Transfer		START		HS State		Image Write (Send Video Stream Packet)
EXIT_SLEEP_MODE	0x11	-		↓	0x05	Sleep out
- Wait	-		Min. 120ms	↓		
SET_DISPLAY_ON	0x29	-		↓	0x05	Display On
↓						
<b>&lt;&lt; Display On &gt;&gt;</b>						

- (C) Sleep in

Item	Address	Parameter	Delay	MIPI State	Data ID	Comment
<b>&lt;&lt; Display On &gt;&gt;</b>						
↓						
(Normal Operation)	-	-		HS State		
SET_DISPLAY_OFF	0x28	-		↓	0x05	Display Off

ENTER_SLEEP_Mode	0x10	-		↓	0x05	Sleep in
- Wait			Min.100ms	↓		
- Host Display Data Transfer		STOP		LP11 State		Image Write (Send Video Stream Packet) Stop
- Wait	-	-	Min. 100ms	LP11 State		
↓						
<< Sleep In >>						

- (D) Power Off

Item	Address	Parameter	Delay	MIPI State	Data ID	Comment
<< Sleep In >>						
↓						
- Reset Active		RESX = 'Low'		LP11 State		
- Wait			Min. 10ms	↓		
- Power Supply VCI		VCI OFF		↓		
- Wait	-	-	Min. 0ms	↓		
- Power Supply VDDI		VDDI OFF		LP00 State		
↓						
<< No Power >>						

9-3-2 3-Power (VDDI/AVDD/AVEE) Mod

- (A) No Power

Item	Address	Parameter	Delay	MIPI State	Data ID	Comment
<b>&lt;&lt; No Power &gt;&gt;</b>						
↓						
- Initial Condition	RESX = 'Low'			LP00 State		
- Power Supply VDDI	VDDI On			↓		Logic Power (Typ.1.8V)
- Wait	-		Min. 0ms	↓		Wait until Power stable
- Power Supply AVDD	AVDD On			LP11 State		Analog(Posi) Power (Typ.5.0V)
- Wait	-		Min. 0ms	↓		Wait until Power Stable
- Power Supply AVEE	AVEE On			LP11 State		Analog(Nega) Power (Typ.-5.0V)
- Wait	-		Min. 20ms	↓		Wait until Power Stable
- Reset Release	RESX = 'High'			↓		
- Wait	-		Min. 1ms	↓		
- Reset Active	RESX = 'Low'			↓		
- Wait	-		Min. 10us	↓		
- Reset Release	RESX = 'High'			↓		
- Wait	-		Min. 20ms	LP11 State		
↓						
<b>&lt;&lt; Sleep In &gt;&gt;</b>						

- (B) Sleep Out

Item	Address	Parameter	Delay	MIPI State	Data ID	Comment
<b>&lt;&lt; Sleep In &gt;&gt;</b>						
↓						
--- Initial Sequence for MIPI Data lane number selection				LP State		Note : Required only for the sample of MTP Non-programming - Refer to "9-3-3 MIPI Data lane number selection"
--- Initial Sequence for 3Power Mode				HS State		Note : Required only for the sample of MTP Non-programming - Refer to "9-3-4 Initial Sequence "
- Host Display Data Transfer	START			HS State		Image Write (Send Video Stream Packet)
EXIT_SLEEP_MODE	0x11	-		↓	0x05	Sleep out
- Wait	-		Min. 120ms	↓		
SET_DISPLAY_ON	0x29	-		↓	0x05	Display On
↓						
<b>&lt;&lt; Display On &gt;&gt;</b>						

- (C) Sleep in

Item	Address	Parameter	Delay	MIPI State	Data ID	Comment
<b>&lt;&lt; Display On &gt;&gt;</b>						



↓						
(Normal Operation)	-	-		HS State		
SET_DISPLAY_OFF	0x28	-		↓	0x05	Display Off
ENTER_SLEEP_Mode	0x10	-		↓	0x05	Sleep in
- Wait			Min.100ms	↓		
- Host Display Data Transfer	STOP			LP11 State		Image Write (Send Video Stream Packet) Stop
- Wait	-	-	Min. 100ms	LP11 State		
↓						
<b>&lt;&lt; Sleep In &gt;&gt;</b>						

- (D) Power Off

Item	Address	Parameter	Delay	MIPI State	Data ID	Comment
<b>&lt;&lt; Sleep In &gt;&gt;</b>						
↓						
- Reset Active	RESX = 'Low'			LP11 State		
- Wait			Min. 10ms	↓		
- Power Supply AVEE	AVEE OFF			↓		
- Wait	-	-	Min. 0ms	↓		
- Power Supply AVDD	AVDD OFF			↓		
- Wait	-	-	Min. 0ms	↓		
- Power Supply VDDI	VDDI OFF			LP00 State		
↓						
<b>&lt;&lt; No Power &gt;&gt;</b>						

9-3-3 MIPI Data Lane number selection

MIPI Data Lane number selection can be MTP one time. When Customer MTP the register first time, the setting value will be programmed. So, The Sequence of the following is unnecessary, if the sample which carried out "MTP Programming" once does not need to change MIPI Data Lane number.

<< MIPI Data Lane = 4 Lane >>

Item	2Power Mode		3Power Mode		Data ID
	Address	Parameter	Address	Parameter	
CMD Page select	0xFF	0x00	0xFF	0x00	0x15
Reload CMD	0xFB	0x01	0xFB	0x01	0x15
SET_MIPI_LANE	0xBA	0x03	0xBA	<b>0x03</b>	0x15

<< MIPI Data Lane = 3 Lane >>

Item	2Power Mode		3Power Mode		Data ID
	Address	Parameter	Address	Parameter	
CMD Page select	0xFF	0x00	0xFF	0x00	0x15
Reload CMD	0xFB	0x01	0xFB	0x01	0x15
SET_MIPI_LANE	0xBA	0x02	0xBA	<b>0x02</b>	0x15

### 9-3-4 Initial Sequence

The Initial Sequence can be MTP on time (except VCOMDC, ID1, ID2, ID3, DDB). When Customer MTP the register first time, the setting value will be programmed. So, the sequence of the following is unnecessary, if the sample which carried out "MTP Programming" once does not need to change each setting values.

Item	Address	2Power Mode	3Power Mode	Data ID	Comment
		Parameter	Parameter		
Page Select	0xFF	0x01	<--	0x15	- <b>CMD2, Page0</b> -
Reload CMD	0xFB	0x01	<--	0x15	Don't reload MTP
Panel CTRL 1	0x00	0x2A	<--	0x15	Normally black, HD720
PWR CTRL1	0x01	0x33	<--	0x15	AVDD/AVEE setting
PWR CTRL2	0x02	0x53	<--	0x15	VGH/VGL setting
PWR CTRL3	0x03	0x55	<--	0x15	-
PWR CTRL4	0x04	0x55	<--	0x15	-
PWR CTRL5	0x05	0x00	<--	0x15	AVDD/AVEE setting
PWR CTRL6	0x06	0x3B	<--	0x15	AVDD/AVEE setting
PWR CTRL 8	0x08	0x26	<--	0x15	VGH/VGL setting
PWR CTRL 9	0x09	0x09	<--	0x15	VGL setting
REG CTRL 1	0x0B	0xCA	<--	0x15	GVDDP setting
REG CTRL 2	0x0C	0xCA	<--	0x15	GVDDN setting
REG CTRL 3	0x0D	0x24	<--	0x15	VCI1 setting
REG CTRL 4	0x0E	0x2B	<--	0x15	VGH setting
REG_CTRL 5	0x0F	0x96	<--	0x15	VGLO setting
REG_CTRL 6	0x10	0x0F	<--	0x15	-
REG CTRL 7	0x11	<i>adjusted value</i>	<i>adjusted value</i>	0x15	<b>VCOMDC voltage setting</b> ✘ Refer to "9-3-5 VCOMDC adjustment "
REG CTRL 8	0x12	0x03	<--	0x15	-
Driver & Panel CTRL	0x14	0x01	<b>0x0C</b>	0x15	Enginner Setting
DDB CTRL1	0x23	<i>user setting</i>	<i>user setting</i>	0x15	- <b>SID[7:0] MIPI member ID number</b>
DDB CTRL2	0x24	<i>user setting</i>	<i>user setting</i>	0x15	- <b>SID[15:8] MIPI member ID number</b>
DDB CTRL3	0x25	<i>user setting</i>	<i>user setting</i>	0x15	- <b>MID[7:0] Module ID</b>
DDB CTRL4	0x26	<i>user setting</i>	<i>user setting</i>	0x15	- <b>MID[15:8] Module ID</b>

DDB CTRL5	0x27	<i>user setting</i>	<i>user setting</i>	0x15	- RID[7:0] Revision ID
DDB CTRL6	0x28	<i>user setting</i>	<i>user setting</i>	0x15	- RID[15:8] Revision ID
Gate CTRL A	0x36	0x73	<--	0x15	gate setting
no description	0x37	0x02	<--	0x15	VGLO pulldown (GND) in Sleep In
WID_CTRL1	0x44	<i>user setting</i>	<i>user setting</i>	0x15	- This read byte identifies the display module's manufacturer.
WID_CTRL2	0x45	<i>user setting</i>	<i>user setting</i>	0x15	- This read byte is used to track the display module/driver version.
WID_CTRL3	0x46	<i>user setting</i>	<i>user setting</i>	0x15	- This read byte identifies the display module/driver.
Auto-detect VBP and VFP	0x4C	0x01	<--	0x15	enable
Gate CTRL B	0x6F	0x00	<--	0x15	gate setting
MIPI CTRL 1	0x71	0x2C	<--	0x15	TA_GO & TA-GET period
Page Leave	FF h	0x00	<--	0x15	CMD1 is Selected.
RELOAD CMD	FB h	0x01	<--	0x15	Don't reload MTP
Gamma Setting	-	-	-		Refer to "9-5 Gamma table"
Page Select	0xFF	0x04	<--	0x15	- CMD2, Page3 - * "CABC function"
Reload CMD	0xFB	0x01	<--	0x15	Don't reload MTP
<p>In CMD2,Page3 , these register is used for "CABC function". Please set up after carrying out sufficient evaluation.</p>					
Page Leave	FF h	0x00	<--	0x15	CMD1 is Selected.
RELOAD CMD	FB h	0x01	<--	0x15	Don't reload MTP
Page Select	0xFF	0x05	<--	0x15	- CMD2, Page4 -
Reload CMD	0xFB	0x01	<--	0x15	Don't reload MTP
CGS CTRL 1	0x01	0x00	<--	0x15	panel timing setting
CGS CTRL 2	0x02	0x7F	<--	0x15	panel timing setting
CGS CTRL 3	0x03	0x7F	<--	0x15	-
CGS CTRL 4	0x04	0x7F	<--	0x15	-
CGS CTRL 5	0x05	0x00	<--	0x15	panel timing setting
CGS CTRL 6	0x06	0x00	<--	0x15	-
CGS CTRL 7	0x07	0x00	<--	0x15	panel timing setting
CGS CTRL 8	0x08	0x00	<--	0x15	-
CGS CTRL 9	0x09	0x02	<--	0x15	panel timing setting
CGS CTRL 10	0x0A	0x01	<--	0x15	panel timing setting
CGS CTRL 11	0x0B	0x75	<--	0x15	panel timing setting
CGS CTRL 12	0x0D	0x0E	<--	0x15	panel timing setting
CGS CTRL 13	0x0E	0x1A	<--	0x15	panel timing setting
CGS CTRL 14	0x0F	0x09	<--	0x15	panel timing setting
CGS CTRL 15	0x10	0x80	<--	0x15	panel timing setting
CGS CTRL 18	0x14	0x04	<--	0x15	panel timing setting
CGS CTRL 19	0x16	0x08	<--	0x15	panel timing setting
CGS CTRL 20	0x17	0x00	<--	0x15	panel timing setting
CGS CTRL 21	0x19	0x1F	<--	0x15	panel timing setting
CGS CTRL 22	0x1A	0x00	<--	0x15	panel timing setting
CGS CTRL 23	0x1B	0xFC	<--	0x15	panel timing setting
CGS CTRL 24	0x1C	0x00	<--	0x15	panel timing setting
CGS CTRL 25	0x1D	0x00	<--	0x15	panel timing setting
CGS CTRL 26	0x1E	0x00	<--	0x15	panel timing setting
CGS CTRL 27	0x1F	0x80	<--	0x15	panel timing setting
Driver & Panel CTRL	0x21	<b>0x00</b>	<--	0x15	panel timing setting (Scanning direction ; Forward='0x00', Backward='0x07')

					※ Refer to "9-3-6 Panel Scanning direction"
Driver & panel CTRL	0x24	0x45	<--	0x15	engineer setting
Driver & panel CTRL	0x27	0x05	<--	0x15	engineer setting
Driver & panel CTRL	0x28	0x00	<--	0x15	engineer setting
Driver & panel CTRL	0x29	0x52	<--	0x15	engineer setting
Driver & panel CTRL	0x2A	0xA9	<--	0x15	engineer setting
Display CTRL 4	0x2D	0x02	<--	0x15	panel timing setting
Driver & panel CTRL	0x2F	0x00	<--	0x15	engineer setting
Driver & panel CTRL	0x30	0x30	<--	0x15	engineer setting
Driver & panel CTRL	0x35	0x16	<--	0x15	engineer setting
GATE CTRL 1	0x36	0x01	<--	0x15	panel timing setting
GATE CTRL 2	0x37	0x00	<--	0x15	panel timing setting
GATE CTRL 3	0x38	0x02	<--	0x15	panel timing setting
GATE CTRL 4	0x39	0x01	<--	0x15	panel timing setting
INIT CTRL 1	0x3F	0x00	<--	0x15	panel timing setting
INIT CTRL 2	0x40	0x00	<--	0x15	panel timing setting
INIT CTRL 3	0x41	0x00	<--	0x15	panel timing setting
INIT CTRL 4	0x42	0x00	<--	0x15	panel timing setting
Driver & panel CTRL	0x4A	0x01	<--	0x15	engineer setting
SWAP CTRL	0x6F	0x25	<--	0x15	Driving setting
Driver & panel CTRL	0x7E	0xE9	<--	0x15	engineer setting
Driver & panel CTRL	0x82	0x18	<--	0x15	engineer setting
Driver & panel CTRL	0x89	0xC1	<--	0x15	engineer setting
Driver & panel CTRL	0xA4	0x05	<--	0x15	Driving setting
PORCH CTRL 1	0xBB	0x06	<--	0x15	FP=6
PORCH CTRL 2	0xBC	0x02	<--	0x15	BP=2
Page Leave	0xFF	0x00	<--	0x15	CMD1 is Selected.
RELOAD CMD2 , PAGE0	0xFB	0x01	<--	0x15	Don't reload MTP

### 9-3-5 VCOMDC adjustment

The method for minimizing "Flicker display" is explained.

#### <Step1>

Please display on a LCD module "Image Pattern (Flicker Pattern)" which shows in the following figure.

- Image Pattern (Flicker Pattern)

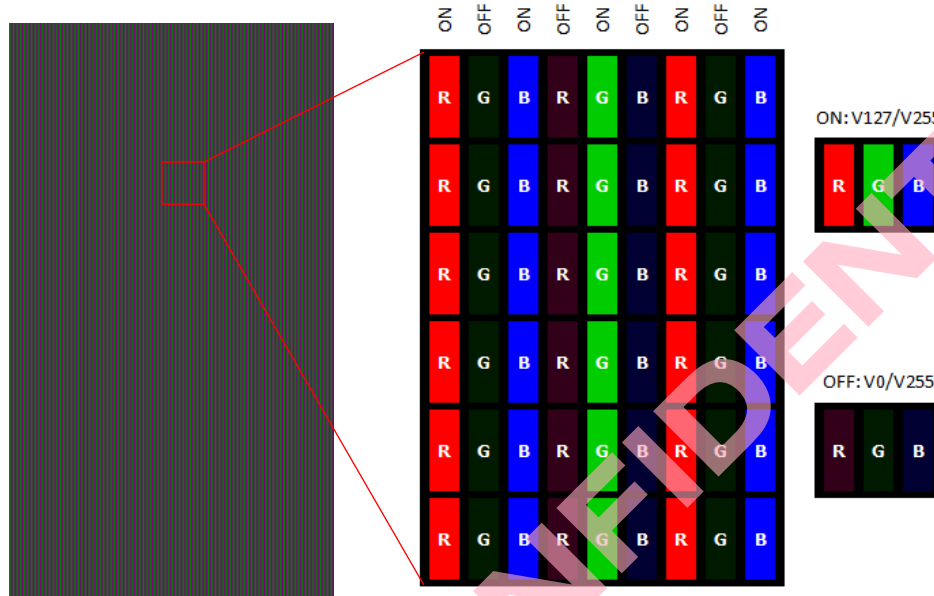

Note) Resolution : 720RGB x 1,280, Color depth : 24bits

#### <Step2>

In order that Flicker may look for the value used as the minimum, please carry out variable of the value of the Driver register "REG CTRL 7 (0x11)". The following figure shows the relation between the Driver register "REG\_CTRL7" Setting value[Hex] and Flicker ratio[%], and point by which flicker is minimized.

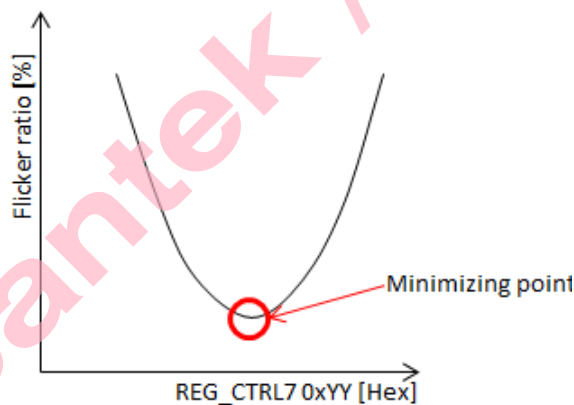

Note ) the point with which Flicker ratio is minimized will be only one point.

#### <Step3>

Please perform the value looked for in Initial Sequence, and carry out "MTP Programming Sequence"

#### <Step4>

Without carrying out Initial Sequence, please carry out Power On Sequence and check whether Flicker is adjusted appropriately.

### 9-3-6 Panel Scanning direction

This LCD module can change the scanning direction Panel. Please set up according to the specification of customer's application.

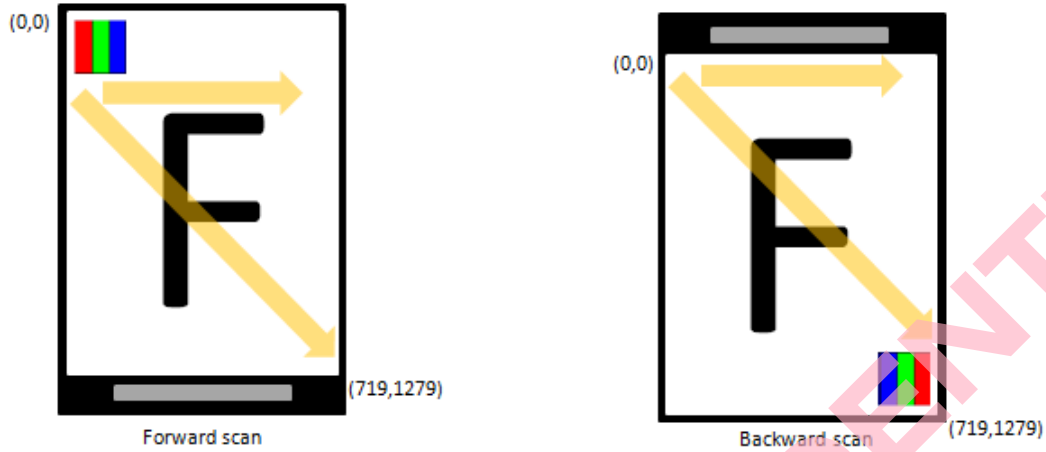

- Forward Scanning direction setting value

Item	Address	Parameter	Data ID	Comment
<< Forward Scan >>				
Page Select	0xFF	0x05	0x15	CMD2, Page0 is selected.
Driver & Panel CTRL	0x21	<b>0x00</b>	0x15	forward scanning direction
Page leave	0xFF	0x00	0x15	CMD1 is selected.

- Backward Scanning direction setting value

Item	Address	Parameter	Data ID	Comment
<< Backward Scan >>				
Page Select	0xFF	0x05	0x15	CMD2, Page0 is selected.
Driver & Panel CTRL	0x21	<b>0x07</b>	0x15	backward scanning direction
Page leave	0xFF	0x00	0x15	CMD1 is selected.

9-4 MTP programming Sequence

Input power for NV memory programming

MTP\_PWR input voltage range: 7.4~7.6(Typical=7.5V). When not under programming, MTP\_PWR pin can be floating or tied to ground. The worse current of MTP\_PWR is 20mA

9-4-1 First time MTP Programming

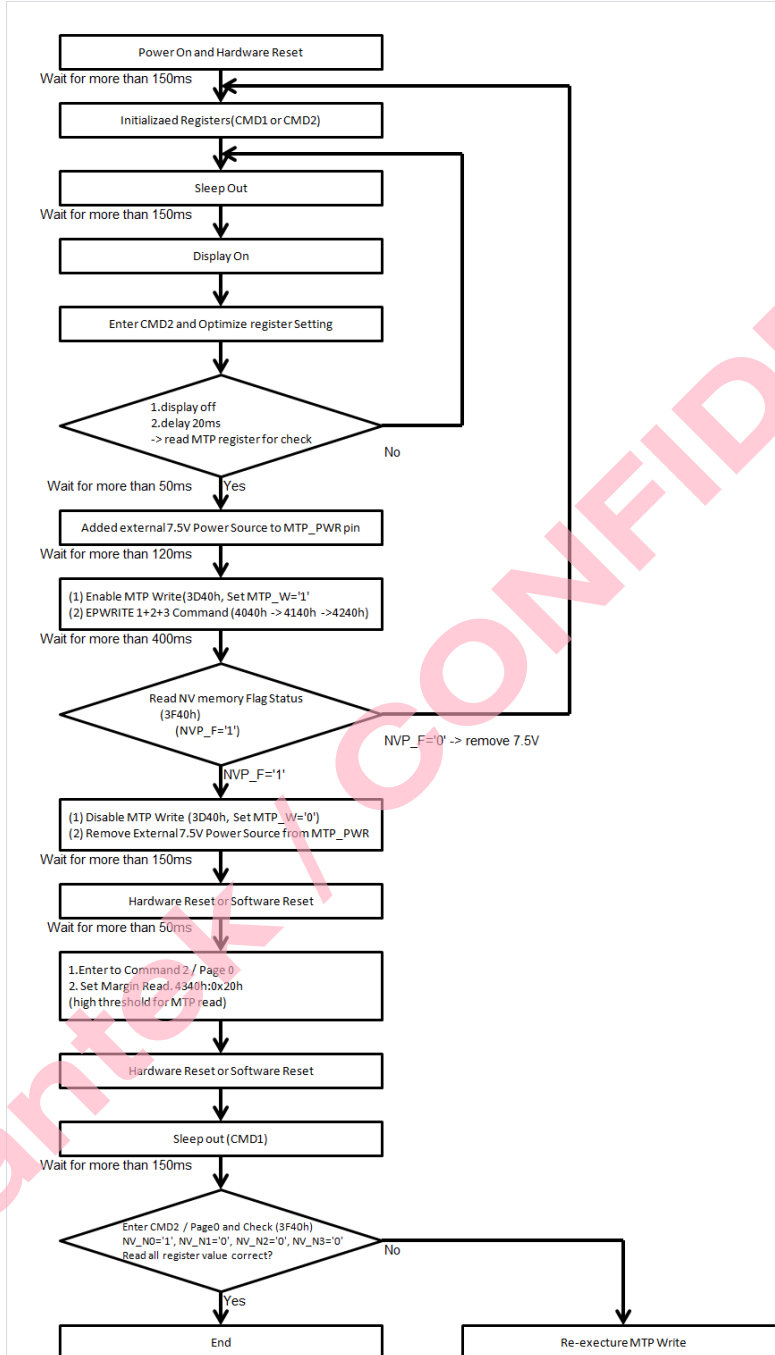

sequence

Note :

1. During this step, user have to ensure that all registers are optimal for display, because most registers “only” have one MTP programming chance.

Sequence of each 2Power mode/3Power mode is shown below.

9-4-1-1 2Power(VDDI/VCI) Mode (1st time MTP Programming)

<< 2 Power Mode >>

Item	Address	Parameter	Delay	MIPI State	Data ID	Comment
- Initial Condition	RESX = 'Low'			LP00 State		
- Power Supply VDDI	VDDI ON			↓		Logic Power (Typ.1.8V)
- Wait	-		Min. 0ms	↓		Wait until Power stable
- Power Supply VCI	VCI ON			LP11 State		Analog Power (Typ.2.8V)
- Wait	-		Min. 20ms	↓		Wait until Power Stable
- Reset Release	RESX = 'High'			↓		
- Wait	-		Min. 1ms	↓		
- Reset Active	RESX = 'Low'			↓		
- Wait	-		Min. 10us	↓		
- Reset Release	RESX = 'High'			↓		
- Wait	-		Min. 150ms	↓		
--- Initial Sequence for MIPI Data lane number selection				LP State		Refer to "9-3-3 MIPI Data lane number selection"
Page select	0xFF	0x01		↓	0x15	CMD2, Page0 is selected
Reload CMD	0xFB	0x01		↓	0x15	Don't reload MTP
RD_CMDSTATUS	0xFE	Read value		↓	0x06	- Expected return value = '0x02'
MTP_CTRL	0x3F	Read value		↓	0x06	- Expected return value = '0x00'
Page Leave	0xFF	0x00		↓	0x15	CMD1 is selected.
Reload CMD	0xFB	0x01		↓	0x15	Don't reload MTP
--- Initial Sequence for 2Power Mode				HS State		Refer to "9-3-4 Initial Sequence for 2power mode"
EXIT_SLEEP_MODE	0x11	-		↓	0x05	Sleep out
- Wait	-		Min. 150ms	↓		
SET_DISPLAY_ON	0x29	-		↓	0x05	Display On
-- Host Display Data Transfer	START			↓		Image : Flicker Pattern
Page select	0xFF	0x01		↓	0x15	CMD2, Page0 is selected
Reload CMD	0xFB	0x01		↓	0x15	Don't reload MTP
RD_CMDSTATUS	0xFE	Read value		↓	0x06	- Expected return value = '0x02'
Page Leave	0xFF	0x00		↓	0x15	CMD1 is selected.
Reload CMD	0xFB	0x01		↓	0x15	Don't reload MTP
RD_CMDSTATUS	0xFE	Read value		↓	0x06	- Expected return value = '0x01'
REG CTRL 7	0x11	0xYY		↓	0x15	Set VCOMDC3_REG[7:0], YY:Optimize value setting
SET_DISPLAY_OFF	0x28	-		↓	0x05	Display Off
- Wait	-		Min. 20ms	↓		
- Host Display Data Transfer	STOP / Continue			LP State / HS State		
(Read each register value for check)						※ If all data is not good, re-execute MTP Write
- Wait	-		Min. 50ms	↓		



- Added external 7.5V(typ.) Power Source to MTP_PWR_pin						
- Wait	-		Min. 120ms	↓		
Page select	0xFF	0x01		↓	0x15	CMD2, Page0 is selected.
Reload CMD	0xFB	0x01		↓	0x15	Don't reload MTP
RD_CMDSTATUS	0xFE	Read value		↓	0x06	- Expected return value = '0x02'
MTP_CTRL1	0x3D	0x01		↓		Enable MTP Write (MTP_W[0]='1')
MTP_CTRL3	0x40	0x55		↓	0x15	EPWRITE1 (4040h=0055h)
MTP_CTRL4	0x41	0xAA		↓	0x15	EPWRITE2 (4140h=00AAh)
MTP_CTRL5	0x42	0x66		↓	0x15	EPWRITE3 (4240h=0066h)
- Wait	-		Min. 400ms	↓		
MTP_CTRL2	0x3F	Read value		↓	0x06	- Expected return value = '0x01'
MTP_CTRL1	0x3D	0x00		↓	0x15	Disable MTP Write (MTP_W[0]='0')
- Removed external 7.5V(Typ.) Power Source from MTP_PWR_pin				↓		
- Wait	-		Min. 150ms	↓		
Page Leave	0xFF	0x00		↓	0x15	CMD1 is selected.
Reload CMD	0xFB	0x01		↓	0x15	Don't reload MTP
RD_CMDSTATUS	0xFE	Read value		↓		- Expected return value = '0x01'
ENTER_SLEEP_MODE	0x10	-		↓	0x15	
- Wait			Min. 100ms	↓		
- Reset Active	RESX = 'Low'			↓		
- Wait	-		Min. 10us	↓		
- Reset Release	RESX = 'High'			↓		
- Wait	-		Min. 150ms	↓		
Page Select	0xFF	0x01		↓	0x15	CMD2, Page0 is selected.
Reload CMD	0xFB	0x01		↓	0x15	Don't reload MTP
RD_CMDSTATUS	0xFE	Read value		↓	0x06	- Expected Return value = '0x02'
MTP_CTRL6	0x43	0x20		↓	0x15	Set Margin Read
(Read each register value for check)				↓		※ If all data is not good, re-executer MTP Write
- Reset Active	RESX = 'Low'			↓		
- Wait	-		Min. 10us	↓		
- Reset Release	RESX = 'High'			↓		
- Wait	-		Min. 20ms	↓		
EXIT_SLEEP_MODE	0x11	-		↓	0x05	Sleep out
- Wait			Min. 120ms	↓		
Page Select	0xFF	0x01		↓	0x15	CMD2, Page0 is selected.
MTP_CTRL2	0x3F	Read value		↓	0x15	- Expected return value = '0x10'
(Read each register value for check)				↓		※ If all data is not good, re- execute MTP Write
Page leave	0xFF	0x00		↓	0x15	CMD1 is selected.
ENTER_SLEEP_MODE	0x10		Min. 100ms	↓	0x05	Sleep in

- Host Display Data Transfer	STOP			LP11 State		Image Write Stop (Send Video Stream Packet)
- Wait	-	-	Min. 100ms	↓		
- Reset Active	RESX = 'Low'			LP00 State		
- Wait			Min. 10ms	↓		
- Power Supply VCI	VCI OFF			↓		
- Wait	-	-	Min. 0ms	↓		
- Power Supply VDDI	VDDI OFF			LP00 State		

Santek / CONFIDENTIAL

9-4-1-2 3Power(VDDI/AVDD/AVEE) Mode (1st time MTP Programming)

<< 3 Power Mode >>

Item	Address	Parameter	Delay	MIPI State	Data ID	Comment
- Initial Condition	RESX = 'Low'			LP00 State		
- Power Supply VDDI	VDDI ON			↓		Logic Power (Typ.1.8V)
- Wait	-		Min. 0ms	↓		Wait until Power stable
- Power Supply AVDD	AVDD ON			LP11 State		Analog(Posi) Power (Typ.5.0V)
- Wait	-		Min. 0ms	↓		Wait until Power Stable
- Power Supply AVEE	AVEE ON			↓		Analog(Nega) Power (Typ.-5.0V)
- Wait	-		Min. 20ms	↓		
- Reset Release	RESX = 'High'			↓		
- Wait	-		Min. 1ms	↓		
- Reset Active	RESX = 'Low'			↓		
- Wait	-		Min. 10us	↓		
- Reset Release	RESX = 'High'			↓		
- Wait	-		Min. 150ms	↓		
--- Initial Sequence for MIPI Data lane number selection				LP State		Refer to "9-3-3 MIPI Data lane number selection"
Page select	0xFF	0x01		↓	0x15	CMD2, Page0 is selected
Reload CMD	0xFB	0x01		↓	0x15	Don't reload MTP
RD_CMDSTATUS	0xFE	Read value		↓	0x06	- Expected return value = '0x02'
MTP_CTRL2	0x3F	Read value		↓	0x06	- Expected return value = '0x00'
Page Leave	0xFF	0x00		↓	0x15	CMD1 is selected.
Reload CMD1	0xFB	0x01		↓	0x15	Don't reload MTP
--- Initial Sequence for 3Power Mode				HS State		Refer to "9-3-4 Initial Sequence for 3power mode"
EXIT_SLEEP_MODE	0x11	-		↓	0x05	Sleep out
- Wait	-		Min. 150ms	↓		
SET_DISPLAY_ON	0x29	-		↓	0x05	Display On
-- Host Display Data Transfer	START			↓		Image : Flicker Pattern
Page select	0xFF	0x01		↓	0x15	CMD2, Page0 is selected
Reload CMD	0xFB	0x01		↓	0x15	Don't reload MTP
RD_CMDSTATUS	0xFE	Read value		↓	0x06	- Expected return value = '0x02'
Page Leave	0xFF	0x00		↓	0x15	CMD1 is selected.
Reload CMD	0xFB	0x01		↓	0x15	Don't reload MTP
RD_CMDSTATUS	0xFE	Read value		↓	0x06	- Expected return value = '0x01'
REG CTRL 7	0x11	0xYY		↓	0x15	Set VCOMDC3_REG[7:0], YY:Optimize value setting
SET_DISPLAY_OFF	0x28	-		↓	0x05	Display Off
- Wait	-		Min. 20ms	↓		
- Host Display Data Transfer	STOP / Continue			LP State / HS State		
(Read each register value for check)						※ If all data is not good,

						re-execute MTP Write
- Wait	-		Min. 50ms	↓		
- Added external 7.5V(typ.) Power Source to MTP_PWR_pin						
- Wait	-		Min. 120ms	↓		
Page select	0xFF	0x01		↓	0x15	CMD2, Page0 is selected.
Reload CMD	0xFB	0x01		↓	0x15	Don't reload MTP
RD_CMDSTATUS	0xFE	Read value		↓	0x06	- Expected return value = '0x02'
MTP_CTRL1	0x3D	0x01		↓		Enable MTP Write (MTP_W[0]='1')
MTP_CTRL3	0x40	0x55		↓	0x15	EPWRITE1 (4040h=0055h)
MTP_CTRL4	0x41	0xAA		↓	0x15	EPWRITE2 (4140h=00AAh)
MTP_CTRL5	0x42	0x66		↓	0x15	EPWRITE3 (4240h=0066h)
- Wait	-		Min. 400ms	↓		
MTP_CTRL2	0x3F	Read value		↓	0x06	- Expected return value = '0x01'
MTP_CTRL1	0x3D	0x00		↓	0x15	Disable MTP Write (MTP_W[0]='0')
- Removed external 7.5V(Typ.) Power Source from TP_PWR_pin						
- Wait	-		Min. 150ms	↓		
Page Leave	0xFF	0x00		↓	0x15	CMD1 is selected.
Reload CMD	0xFB	0x01		↓	0x15	Don't reload MTP
RD_CMDSTATUS	0xFE	Read value		↓		- Expected return value = '0x01'
ENTER_SLEEP_MODE	0x10	-		↓	0x15	
- Wait	-		Min. 100ms	↓		
- Reset Active	RESX = 'Low'			↓		
- Wait	-		Min. 10us	↓		
- Reset Release	RESX = 'High'			↓		
- Wait	-		Min. 150ms	↓		
Page Select	0xFF	0x01		↓	0x15	CMD2, Page0 is selected.
Reload CMD	0xFB	0x01		↓	0x15	Don't reload MTP
RD_CMDSTATUS	0xFE	Read value		↓	0x06	- Expected Return value = '0x02'
MTP_CTRL6	0x43	0x20		↓	0x15	Set Margin Read
(Read each register value for check)				↓		※ If all data is not good, re-execute MTP Write
- Reset Active	RESX = 'Low'			↓		
- Wait	-		Min. 10us	↓		
- Reset Release	RESX = 'High'			↓		
- Wait	-		Min. 20ms	↓		
EXIT_SLEEP_MODE	0x11	-		↓	0x05	Sleep out
- Wait	-		Min. 120ms	↓		
Page Select	0xFF	0x01		↓	0x15	CMD2, Page0 is selected.
MTP_CTRL2	0x3F	Read value		↓	0x15	- Expected return value = '0x10'
(Read each register value for check)				↓		※ If all data is not good, re-execute MTP Write
Page leave	0xFF	0x00		↓	0x15	CMD1 is selected.
ENTER_SLEEP_MODE	0x10		Min. 100ms	↓	0x05	Sleep in
- Host Display Data Transfer	STOP				LP11 State	Image Write Stop (Send Video Stream)

					Packet)
- Wait	-	-	Min. 100ms	↓	
- Reset Active	RESX = 'Low'			LP00 State	
- Wait			Min. 10ms	↓	
- Power Supply AVEE	AVEE OFF			↓	
- Wait	-	-	Min. 0ms	↓	
- Power Supply AVDD	AVDD OFF			↓	
- Wait	-	-	Min. 0ms	↓	
- Power Supply VDDI	VDDI OFF			LP00 State	

Santek / CONFIDENTIAL

9-4-2 Second times MTP Programming sequence

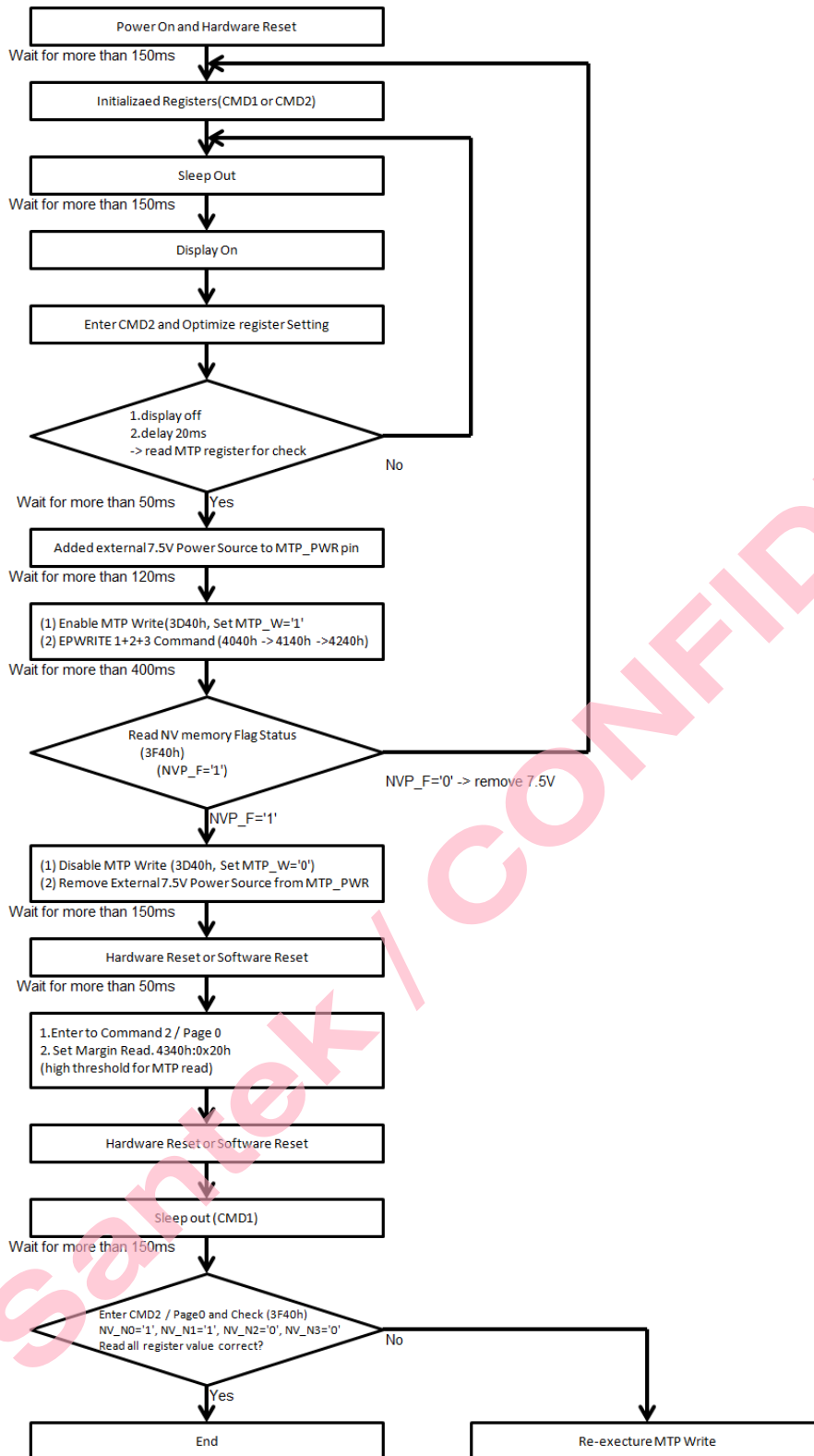

Sequence of each 2Power mode/3Power mode is shown below.  
9-4-2-1 2Power(VDDI/VCI) Mode (2nd times MTP Programming)  
<< 2 Power Mode >>

Item	Address	Parameter	Delay	MIPI State	Data ID	Comment
- Initial Condition	RESX = 'Low'			LP00 State		
- Power Supply VDDI	VDDI On			LP11 State		Logic Power (Typ.1.8V)
- Wait	-		Min. 0ms	↓		Wait until Power Stable
- Power Supply VCI	VCI ON			LP11 State		Analog Power (Typ.2.8V)
- Wait	-		Min. 20ms	↓		Wait until Power Stable
- Reset Release	RESX = 'High'			↓		
- Wait	-		Min. 1ms	↓		
- Reset Active	RESX = 'Low'			↓		
- Wait	-		Min. 10us	↓		
- Reset Release	RESX = 'High'			↓		
- Wait	-		Min. 150ms	↓		
--- Initial Sequence for MIPI Data lane number selection				LP State		Refer to "9-3-3 MIPI Data lane number selection"
Page select	0xFF	0x01		↓	0x15	CMD2, Page0 is selected
Reload CMD	0xFB	0x01		↓	0x15	Don't reload MTP
RD_CMDSTATUS	0xFE	Read value		↓	0x06	- Expected return value = '0x02'
MTP_CTRL2	0x3F	Read value		↓	0x06	- Expected return value = '0x10'
MTP_CTRL2	0x3F	Read value		↓	0x06	- Expected return value = '0x10'
DDB_CTRL1	0x23	user setting		↓	0x15	- SID[7:0] MIPI member ID number
DDB_CTRL2	0x24	user setting		↓	0x15	- SID[15:8] MIPI member ID number
DDB_CTRL3	0x25	user setting		↓	0x15	- MID[7:0] Module ID
DDB_CTRL4	0x26	user setting		↓	0x15	- MID[15:8] Module ID
DDB_CTRL5	0x27	user setting		↓	0x15	- RID[7:0] Revision ID
DDB_CTRL6	0x28	user setting		↓	0x15	- RID[15:8] Revision ID
WID_CTRL1	0x44	user setting		↓	0x15	- This read byte identifies the display module's manufacturer.
WID_CTRL2	0x45	user setting		↓	0x15	- This read byte is used to track the display module/driver version.
WID_CTRL3	0x46	user setting		↓	0x15	- This read byte identifies the display module/driver.
Page Leave	0xFF	0x00		↓	0x15	CMD1 is selected.
Reload CMD	0xFB	0x01		↓	0x15	Don't reload MTP
RD_CMDSTATUS	0xFE	Read value		↓	0x06	- Expected return value = '0x01'
--- Initial Sequence for 2Power Mode				HS State		Refer to "9-3-4 Initial Sequence for 2power mode"
EXIT_SLEEP_MODE	0x11	-		↓	0x05	Sleep out
- Wait	-		Min. 150ms	↓		
SET_DISPLAY_ON	0x29	-		↓	0x05	Display On
-- Host Display Data Transfer	START			↓		Image : Flicker Pattern
Page select	0xFF	0x01		↓	0x15	CMD2, Page0 is selected
Reload CMD	0xFB	0x01		↓	0x15	Don't reload MTP

RD_CMDSTATUS	0xFE	Read value		↓	0x06	- Expected return value = '0x02'
Page Leave	0xFF	0x00		↓	0x15	CMD1 is selected.
Reload CMD	0xFB	0x01		↓	0x15	Don't reload MTP
RD_CMDSTATUS	0xFE	Read value		↓	0x06	- Expected return value = '0x01'
REG CTRL 7	0x11	0xYY		↓	0x15	Set VCOMDC3_REG[7:0], YY:Optimize value setting
SET_DISPLAY_OFF	0x28	-		↓	0x05	Display Off
- Wait	-		Min. 20ms	↓		
- Host Display Data Transfer	STOP / Continue			LP State / HS State		
(Read each register value for check)						※ If all data is not good, re-execute MTP Write
- Wait	-		Min. 50ms	↓		
- Added external 7.5V(typ.) Power Source to MTP_PWR_pin						
- Wait	-		Min. 120ms	↓		
Page select	0xFF	0x01		↓	0x15	CMD2, Page0 is selected.
Reload CMD	0xFB	0x01		↓	0x15	Don't reload MTP
RD_CMDSTATUS	0xFE	Read value		↓	0x06	- Expected return value = '0x02'
MTP_CTRL1	0x3D	0x01		↓		Enable MTP Write (MTP_W[0]='1')
MTP_CTRL3	0x40	0x55		↓	0x15	EPWRITE1(4040h=0055h)
MTP_CTRL4	0x41	0xAA		↓	0x15	EPWRITE2(4140h=00AAh)
MTP_CTRL5	0x42	0x66		↓	0x15	EPWRITE3(4240h=0066h)
- Wait	-		Min. 400ms	↓		
MTP_CTRL2	0x3F	Read value		↓	0x06	- Expected return value = '0x11'
MTP_CTRL1	0x3D	0x00		↓	0x15	Disable MTP Write (MTP_W[0]='0')
- Removed external 7.5V(Typ.) Power Source from MTP_PWR_pin						
- Wait	-		Min. 150ms	↓		
Page Leave	0xFF	0x00		↓	0x15	CMD1 is selected.
Reload CMD	0xFB	0x01		↓	0x15	Don't reload MTP
RD_CMDSTATUS	0xFE	Read value		↓		- Expected return value = '0x01'
ENTER_SLEEP_MODE	0x10	-		↓	0x15	
- Wait	-		Min. 100ms	↓		
- Reset Active	RESX = 'Low'			↓		
- Wait	-		Min. 10us	↓		
- Reset Release	RESX = 'High'			↓		
- Wait	-		Min. 150ms	↓		
Page Select	0xFF	0x01		↓	0x15	CMD2, Page0 is selected.
Reload CMD	0xFB	0x01		↓	0x15	Don't reload MTP
RD_CMDSTATUS	0xFE	Read value		↓	0x06	- Expected Return value = '0x02'
MTP_CTRL6	0x43	0x20		↓	0x15	Set Margin Read
(Read each register value for check)						※ If all data is not good, re-execute MTP Write
- Reset Active	RESX = 'Low'			↓		
- Wait	-		Min. 10us	↓		
- Reset Release	RESX = 'High'			↓		
- Wait	-		Min. 20ms	↓		
EXIT_SLEEP_MODE	0x11	-		↓	0x05	Sleep out



- Wait			Min. 120ms	↓		
Page Select	0xFF	0x01		↓	0x15	CMD2, Page0 is selected.
MTP_CTRL2	0x3F	Read value		↓	0x15	- Expected return value = '0x30'
(Read each register value for check)				↓		※ If all data is not good, re-execute MTP Write
Page leave	0xFF	0x00		↓	0x15	CMD1 is selected.
ENTER_SLEEP_MODE	0x10		Min. 100ms	↓	0x05	Sleep in
- Host Display Data Transfer	STOP				LP11 State	Image Write (Send Video Stream Packet) Stop
- Wait	-	-	Min. 100ms	↓		
- Reset Active	RESX = 'Low'				LP00 State	
- Wait			Min. 10ms	↓		
- Power Supply VCI	VCI OFF			↓		
- Wait	-	-	Min. 0ms	↓		
- Power Supply VDDI	VDDI OFF				LP00 State	

9-4-2-2 3Power(VDDI/AVDD/AVEE) Mode (2<sup>nd</sup> times MTP Programming)

<< 3 Power Mode >>

Item	Address	Parameter	Delay	MIPI State	Data ID	Comment
- Initial Condition	RESX = 'Low'			LP00 State		
- Power Supply VDDI	VDDI ON			↓		Logic Power (Typ.1.8V)
- Wait	-		Min. 0ms	↓		Wait until Power stable
- Power Supply AVDD	AVDD ON			LP11 State		Analog(Posi) Power (Typ.5.0V)
- Wait	-		Min. 0ms	↓		Wait until Power Stable
- Power Supply AVEE	AVEE ON			↓		Analog(Nega) Power (Typ.-5.0V)
- Wait	-		Min. 20ms	↓		
- Reset Release	RESX = 'High'			↓		
- Wait	-		Min. 1ms	↓		
- Reset Active	RESX = 'Low'			↓		
- Wait	-		Min. 10us	↓		
- Reset Release	RESX = 'High'			↓		
- Wait	-		Min. 150ms	↓		
--- Initial Sequence for MIPI Data lane number selection				LP State		Refer to "9-3-3 MIPI Data lane number selection"
Page select	0xFF	0x01		↓	0x15	CMD2, Page0 is selected
Reload CMD	0xFB	0x01		↓	0x15	Don't reload MTP
RD_CMDSTATUS	0xFE	Read value		↓	0x06	- Expected return value = '0x02'
MTP_CTRL2	0x3F	Read value		↓	0x06	- Expected return value = '0x10'
DDB_CTRL1	0x23	user setting		↓	0x15	- SID[7:0] MIPI member ID number
DDB_CTRL2	0x24	user setting		↓	0x15	- SID[15:8] MIPI member ID number
DDB_CTRL3	0x25	user setting		↓	0x15	- MID[7:0] Module ID
DDB_CTRL4	0x26	user setting		↓	0x15	- MID[15:8] Module ID
DDB_CTRL5	0x27	user setting		↓	0x15	- RID[7:0] Revision ID
DDB_CTRL6	0x28	user setting		↓	0x15	- RID[15:8] Revision ID
WID_CTRL1	0x44	user setting		↓	0x15	- This read byte identifies the display module's manufacturer.
WID_CTRL2	0x45	user setting		↓	0x15	- This read byte is used to track the display module/driver version.
WID_CTRL3	0x46	user setting		↓	0x15	- This read byte identifies the display module/driver.
Page Leave	0xFF	0x00		↓	0x15	CMD1 is selected.
Reload CMD	0xFB	0x01		↓	0x15	Don't reload MTP
RD_CMDSTATUS	0xFE	Read value		↓	0x06	- Expected return value = '0x01'
--- Initial Sequence for 3Power Mode				HS State		Refer to "9-3-4 Initial Sequence for 3power mode"
EXIT_SLEEP_MODE	0x11	-		↓	0x05	Sleep out
- Wait	-		Min. 150ms	↓		
SET_DISPLAY_ON	0x29	-		↓	0x05	Display On
-- Host Display Data Transfer	START			↓		Image : Flicker Pattern
Page select	0xFF	0x01		↓	0x15	CMD2, Page0 is selected
Reload CMD	0xFB	0x01		↓	0x15	Don't reload MTP
RD_CMDSTATUS	0xFE	Read value		↓	0x06	- Expected return value =

						'0x02'
Page Leave	0xFF	0x00		↓	0x15	CMD1 is selected.
Reload CMD	0xFB	0x01		↓	0x15	Don't reload MTP
RD_CMDSTATUS	0xFE	Read value		↓	0x06	- Expected return value = '0x01'
REG CTRL 7	0x11	0xYY		↓	0x15	Set VCOMDC3_REG[7:0], YY:Optimize value setting
SET_DISPLAY_OFF	0x28	-		↓	0x05	Display Off
- Wait	-		Min. 20ms	↓		
- Host Display Data Transfer	STOP / Continue					LP State / HS State
(Read each register value for check)						※ If all data is not good, re-execute MTP Write
- Wait	-		Min. 50ms	↓		
- Added external 7.5V(typ.) Power Source to MTP_PWR_pin						
- Wait	-		Min. 120ms	↓		
Page select	0xFF	0x01		↓	0x15	CMD2, Page0 is selected.
Reload CMD	0xFB	0x01		↓	0x15	Don't reload MTP
RD_CMDSTATUS	0xFE	Read value		↓	0x06	- Expected return value = '0x02'
MTP_CTRL1	0x3D	0x01		↓		Enable MTP Write (MTP_W[0]='1')
MTP_CTRL3	0x40	0x55		↓	0x15	EPWRITE1(4040h=0055h)
MTP_CTRL4	0x41	0xAA		↓	0x15	EPWRITE2(4140h=00AAh)
MTP_CTRL5	0x42	0x66		↓	0x15	EPWRITE3(4240h=0066h)
- Wait	-		Min. 400ms	↓		
MTP_CTRL2	0x3F	Read value		↓	0x06	- Expected return value = '0x11'
MTP_CTRL1	0x3D	0x00		↓	0x15	Disable MTP Write (MTP_W[0]='0')
- Removed external 7.5V(Typ.) Power Source from MTP_PWR_pin						
- Wait	-		Min .150ms	↓		
Page Leave	0xFF	0x00		↓	0x15	CMD1 is selected.
Reload CMD	0xFB	0x01		↓	0x15	Don't reload MTP
RD_CMDSTATUS	0xFE	Read value		↓		- Expected return value = '0x01'
ENTER_SLEEP_MODE	0x10	-		↓	0x15	
- Wait	-		Min. 100ms	↓		
- Reset Active	RESX = 'Low'			↓		
- Wait	-		Min. 10us	↓		
- Reset Release	RESX = 'High'			↓		
- Wait	-		Min. 150ms	↓		
Page Select	0xFF	0x01		↓	0x15	CMD2, Page0 is selected.
Reload CMD	0xFB	0x01		↓	0x15	Don't reload MTP
RD_CMDSTATUS	0xFE	Read value		↓	0x06	- Expected Return value = '0x02'
MTP_CTRL6	0x43	0x20		↓	0x15	Set Margin Read
(Read each register value for check)						※ If all data is not good, re-execute MTP Write
- Reset Active	RESX = 'Low'			↓		
- Wait	-		Min. 10us	↓		
- Reset Release	RESX = 'High'			↓		
- Wait	-		Min. 20ms	↓		
EXIT_SLEEP_MODE	0x11	-		↓	0x05	Sleep out
- Wait	-		Min. 120ms	↓		

Page Select	0xFF	0x01		↓	0x15	CMD2, Page0 is selected.
MTP_CTRL2	0x3F	Read value		↓	0x15	- Expected return value = '0x30'
(Read each register value for check)				↓		※ If all data is not good, re-execute MTP Write
Page leave	0xFF	0x00		↓	0x15	CMD1 is selected.
ENTER_SLEEP_MODE	0x10		Min. 100ms	↓	0x05	Sleep in
- Host Display Data Transfer	STOP			LP11 State		Image Write (Send Video Stream Packet) Stop
- Wait	-	-	Min. 100ms	↓		
- Reset Active	RESX = 'Low'			LP00 State		
- Wait			Min. 10ms	↓		
- Power Supply AVEE	AVEE OFF			↓		
- Wait	-	-	Min. 0ms	↓		
- Power Supply AVDD	AVDD OFF			↓		
- Wait	-	-	Min. 0ms	↓		
- Power Supply VDDI	VDDI OFF			LP00 State		

9-4-3 third times MTP Programming sequence

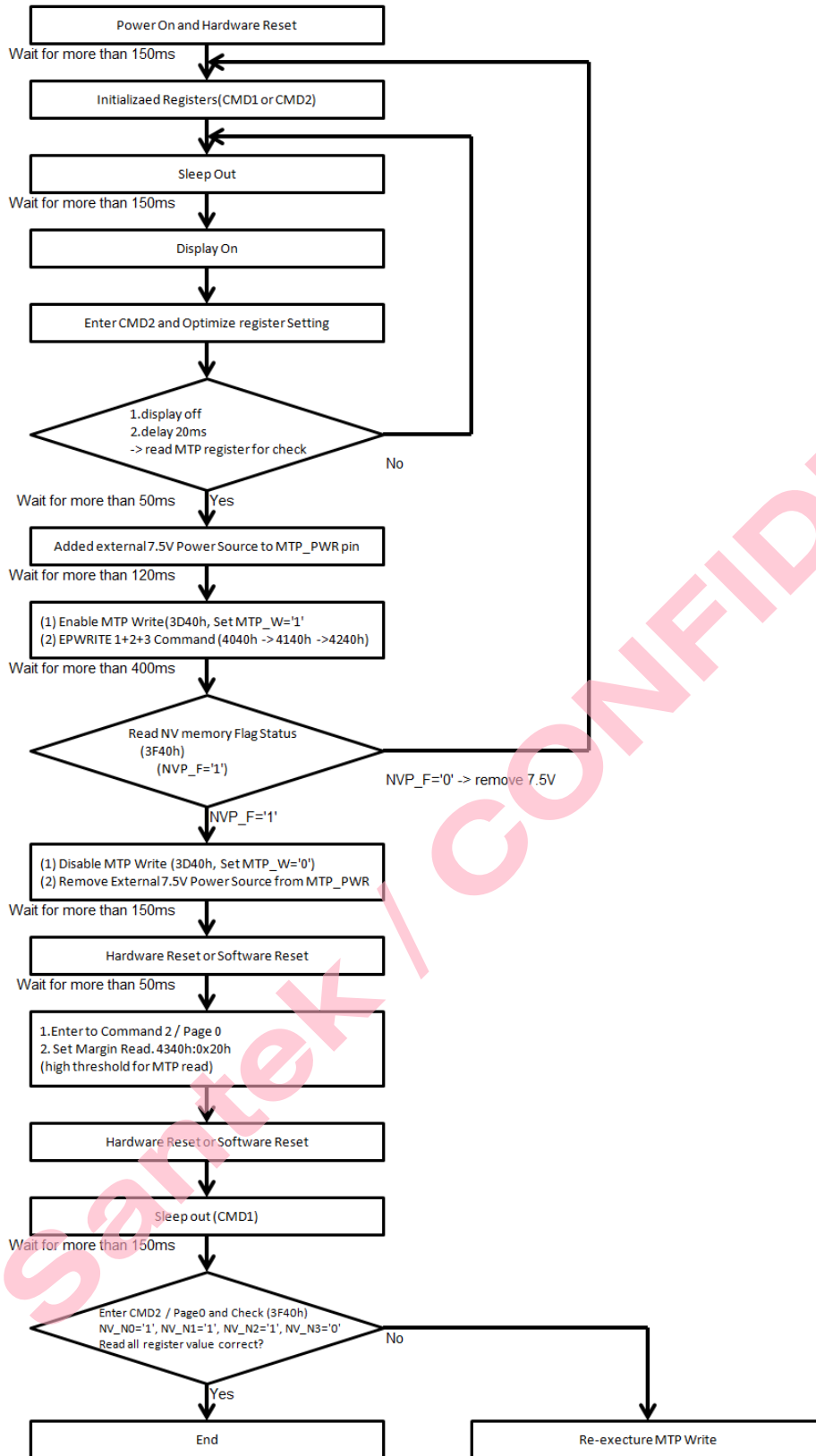

Sequence of each 2Power mode/3Power mode is shown below.  
9-4-3-1 2Power(VDDI/VCI) Mode (3rd times MTP Programming)

<< 2 Power Mode >>

Item	Address	Parameter	Delay	MIPI State	Data ID	Comment
- Power Supply VDDI	VDDI ON			↓		Logic Power (Typ.1.8V)
- Wait	-		Min. 0ms	↓		Wait until Power stable
- Power Supply VCI	VCI ON			LP11 State		Analog Power (Typ.2.8V)
- Wait	-		Min. 20ms	↓		Wait until Power Stable
- Reset Release	RESX = 'High'			↓		
- Wait	-		Min. 1ms	↓		
- Reset Active	RESX = 'Low'			↓		
- Wait	-		Min. 10us	↓		
- Reset Release	RESX = 'High'			↓		
- Wait	-		Min. 150ms	↓		
--- Initial Sequence for MIPI Data lane number selection				LP State		Refer to "MIPI Data lane number selection"
Page select	0xFF	0x01		↓	0x15	CMD2, Page0 is selected
Reload CMD	0xFB	0x01		↓	0x15	Don't reload MTP
RD_CMDSTATUS	0xFE	Read value		↓	0x06	- Expected return value = '0x02'
MTP_CTRL2	0x3F	Read value		↓	0x06	- Expected return value = '0x30'
DDB_CTRL1	0x23	user setting		↓	0x15	- SID[7:0] MIPI member ID number
DDB_CTRL2	0x24	user setting		↓	0x15	- SID[15:8] MIPI member ID number
DDB_CTRL3	0x25	user setting		↓	0x15	- MID[7:0] Module ID
DDB_CTRL4	0x26	user setting		↓	0x15	- MID[15:8] Module ID
DDB_CTRL5	0x27	user setting		↓	0x15	- RID[7:0] Revision ID
DDBCTRL6	0x28	user setting		↓	0x15	- RID[15:8] Revision ID
WID_CTRL1	0x44	user setting		↓	0x15	- This read byte identifies the display module's manufacturer.
WID_CTRL2	0x45	user setting		↓	0x15	- This read byte is used to track the display module/driver version.
WID_CTRL3	0x46	user setting		↓	0x15	- This read byte identifies the display module/driver.
Page Leave	0xFF	0x00		↓	0x15	CMD1 is selected.
Reload CMD	0xFB	0x01		↓	0x15	Don't reload MTP
RD_CMDSTATUS	0xFE	Read value		↓	0x06	- Expected return value = '0x01'
--- Initial Sequence for 2Power Mode				HS State		Refer to "9-3-4 Initial Sequence for 2power mode"
EXIT_SLEEP_MODE	0x11	-		↓	0x05	Sleep out
- Wait	-		Min. 150ms	↓		
SET_DISPLAY_ON	0x29	-		↓	0x05	Display On
-- Host Display Data Transfer	START			↓		Image : Flicker Pattern
Page select	0xFF	0x01		↓	0x15	CMD2, Page0 is selected
Reload CMD	0xFB	0x01		↓	0x15	Don't reload MTP

RD_CMDSTATUS	0xFE	Read value		↓	0x06	- Expected return value = '0x02'
Page Leave	0xFF	0x00		↓	0x15	CMD1 is selected.
Reload CMD1	0xFB	0x01		↓	0x15	Don't reload MTP
RD_CMDSTATUS	0xFE	Read value		↓	0x06	- Expected return value = '0x01'
REG CTRL 7	0x11	0xYY		↓	0x15	Set VCOMDC3_REG[7:0], YY:Optimize value setting
SET_DISPLAY_OFF	0x28	-		↓	0x05	Display Off
- Wait	-		Min. 20ms	↓		
- Host Display Data Transfer	STOP / Continue				LP State / HS State	
(Read each register value for check)						※ If all data is not good, re-execute MTP Write
- Wait	-		Min. 50ms	↓		
- Added external 7.5V(typ.) Power Source to MTP_PWR_pin						
- Wait	-		Min. 120ms	↓		
Page select	0xFF	0x01		↓	0x15	CMD2, Page0 is selected.
Reload CMD	0xFB	0x01		↓	0x15	Don't reload MTP
RD_CMDSTATUS	0xFE	Read value		↓	0x06	- Expected return value = '0x02'
MTP_CTRL1	0x3D	0x01		↓		Enable MTP Write (MTP_W[0]='1')
MTP_CTRL3	0x40	0x55		↓	0x15	EPWRITE1(4040h=0055h)
MTP_CTRL4	0x41	0xAA		↓	0x15	EPWRITE2(4140h=00AAh)
MTP_CTRL5	0x42	0x66		↓	0x15	EPWRITE3(4240h=0066h)
- Wait	-		Min. 400ms	↓		
MTP_CTRL2	0x3F	Read value		↓	0x06	- Expected return value = '0x31'
MTP_CTRL1	0x3D	0x00		↓	0x15	Disable MTP Write (MTP_W[0]='0')
- Removed external 7.5V(Typ.) Power Source from MTP_PWR_pin						
- Wait	-		Min. 150ms	↓		
Page Leave	0xFF	0x00		↓	0x15	CMD1 is selected.
Reload CMD	0xFB	0x01		↓	0x15	Don't reload MTP
RD_CMDSTATUS	0xFE	Read value		↓	0x06	- Expected return value = '0x01'
ENTER_SLEEP_MODE	0x10	-		↓	0x15	
- Wait			Min. 100ms	↓		
- Reset Active	RESX = 'Low'			↓		
- Wait	-		Min. 10us	↓		
- Reset Release	RESX = 'High'			↓		
- Wait	-		Min. 150ms	↓		
Page Select	0xFF	0x01		↓	0x15	CMD2, Page0 is selected.
Reload CMD	0xFB	0x01		↓	0x15	Don't reload MTP
RD_CMDSTATUS	0xFE	Read value		↓	0x06	- Expected Return value = '0x02'
MTP_CTRL6	0x43	0x20		↓	0x15	Set Margin Read
(Read each register value for check)						※ If all data is not good, re-execute MTP Write
- Reset Active	RESX = 'Low'			↓		
- Wait	-		Min. 10us	↓		
- Reset Release	RESX = 'High'			↓		
- Wait	-		Min. 20ms	↓		
EXIT_SLEEP_MODE	0x11	-		↓	0x05	Sleep out

- Wait			Min. 120ms	↓		
Page Select	0xFF	0x01		↓	0x15	CMD2, Page0 is selected.
MTP_CTRL2	0x3F	Read value		↓	0x15	- Expected return value = '0x70'
(Read each register value for check)				↓		※ If all data is not good, re-execute MTP Write
Page leave	0xFF	0x00		↓	0x15	CMD1 is selected.
ENTER_SLEEP_MODE	0x10		Min. 100ms	↓	0x05	Sleep in
- Host Display Data Transfer	STOP				LP11 State	Image Write (Send Video Stream Packet) Stop
- Wait	-	-	Min. 100ms	↓		
- Reset Active	RESX = 'Low'				LP00 State	
- Wait			Min. 10ms	↓		
- Power Supply VCI	VCI OFF			↓		
- Wait	-	-	Min. 0ms	↓		
- Power Supply VDDI	VDDI OFF				LP00 State	



9-4-3-2 3Power(VDDI/AVDD/AVEE) Mode (3rd times MTP Programming)

<< 3 Power Mode >>

Item	Address	Parameter	Delay	MIPI State	Data ID	Comment
- Initial Condition	RESX = 'Low'			LP00 State		
- Power Supply VDDI	VDDI ON			↓		Logic Power (Typ.1.8V)
- Wait	-		Min. 0ms	↓		Wait until Power stable
- Power Supply AVDD	AVDD ON			LP11 State		Analog(Posi) Power (Typ.5.0V)
- Wait	-		Min. 0ms	↓		Wait until Power Stable
- Power Supply AVEE	AVEE ON			↓		Analog(Nega) Power (Typ.-5.0V)
- Wait	-		Min. 20ms	↓		
- Reset Release	RESX = 'High'			↓		
- Wait	-		Min. 1ms	↓		
- Reset Active	RESX = 'Low'			↓		
- Wait	-		Min. 10us	↓		
- Reset Release	RESX = 'High'			↓		
- Wait	-		Min. 150ms	↓		
--- Initial Sequence for MIPI Data lane number selection				LP State		Refer to "9-3-3 MIPI Data lane number selection"
Page select	0xFF	0x01		↓	0x15	CMD2, Page0 is selected
Reload CMD	0xFB	0x01		↓	0x15	Don't reload MTP
RD_CMDSTATUS	0xFE	Read value		↓	0x06	- Expected return value = '0x02'
MTP_CTRL2	0x3F	Read value		↓	0x06	- Expected return value = '0x30'
DDB_CTRL1	0x23	user setting		↓	0x15	- SID[7:0] MIPI member ID number
DDB_CTRL2	0x24	user setting		↓	0x15	- SID[15:8] MIPI member ID number
DDB_CTRL3	0x25	user setting		↓	0x15	- MID[7:0] Module ID
DDB_CTRL4	0x26	user setting		↓	0x15	- MID[15:8] Module ID
DDB_CTRL5	0x27	user setting		↓	0x15	- RID[7:0] Revision ID
DDB_CTRL6	0x28	user setting		↓	0x15	- RID[15:8] Revision ID
WID_CTRL1	0x44	user setting		↓	0x15	- This read byte identifies the display module's manufacturer.
WID_CTRL2	0x45	user setting		↓	0x15	- This read byte is used to track the display module/driver version.
WID_CTRL3	0x46	user setting		↓	0x15	- This read byte identifies the display module/driver.
Page Leave	0xFF	0x00		↓	0x15	CMD1 is selected.
Reload CMD	0xFB	0x01		↓	0x15	Don't reload MTP
RD_CMDSTATUS	0xFE	Read value		↓	0x06	- Expected return value = '0x01'
--- Initial Sequence for 3Power Mode				HS State		Refer to "9-3-3 Initial Sequence for 3power mode"
EXIT_SLEEP_MODE	0x11	-		↓	0x05	Sleep out
- Wait	-		Min. 150ms	↓		
SET_DISPLAY_ON	0x29	-		↓	0x05	Display On
-- Host Display Data Transfer	START			↓		Image : Flicker Pattern
Page select	0xFF	0x01		↓	0x15	CMD2, Page0 is selected
Reload CMD	0xFB	0x01		↓	0x15	Don't reload MTP
RD_CMDSTATUS	0xFE	Read value		↓	0x06	- Expected return value =

						'0x02'
Page Leave	0xFF	0x00		↓	0x15	CMD1 is selected.
Reload CMD	0xFB	0x01		↓	0x15	Don't reload MTP
RD_CMDSTATUS	0xFE	Read value		↓	0x06	- Expected return value = '0x01'
REG_CTRL 7	0x11	0xYY		↓	0x15	Set VCOMDC3_REG[7:0], YY:Optimize value setting
SET_DISPLAY_OFF	0x28	-		↓	0x05	Display Off
- Wait		-	Min. 20ms	↓		
- Host Display Data Transfer	STOP / Continue					LP State / HS State
(Read each register value for check)						※ If all data is not good, re-execute MTP Write
- Wait		-	Min. 50ms	↓		
- Added external 7.5V(typ.) Power Source to MTP_PWR_pin						
- Wait		-	Min. 120ms	↓		
Page select	0xFF	0x01		↓	0x15	CMD2, Page0 is selected.
Reload CMD	0xFB	0x01		↓	0x15	Don't reload MTP
RD_CMDSTATUS	0xFE	Read value		↓	0x06	- Expected return value = '0x02'
MTP_CTRL1	0x3D	0x01		↓		Enable MTP Write (MTP_W[0]='1')
MTP_CTRL3	0x40	0x55		↓	0x15	EPWRITE1(4040h=0055h)
MTP_CTRL4	0x41	0xAA		↓	0x15	EPWRITE2(4140h=00AAh)
MTP_CTRL5	0x42	0x66		↓	0x15	EPWRITE3(4240h=0066h)
- Wait		-	Min. 400ms	↓		
MTP_CTRL2	0x3F	Read value		↓	0x06	- Expected return value = '0x31'
MTP_CTRL1	0x3D	0x00		↓	0x15	Disable MTP Write (MTP_W[0]='0')
- Removed external 7.5V(Typ.) Power Source from MTP_PWR_pin						
- Wait		-	Min .150ms	↓		
Page Leave	0xFF	0x00		↓	0x15	CMD1 is selected.
Reload CMD	0xFB	0x01		↓	0x15	Don't reload MTP
RD_CMDSTATUS	0xFE	Read value		↓		- Expected return value = '0x01'
ENTER_SLEEP_MODE	0x10	-		↓	0x15	
- Wait			Min. 100ms	↓		
- Reset Active	RESX = 'Low'			↓		
- Wait		-	Min. 10us	↓		
- Reset Release	RESX = 'High'			↓		
- Wait		-	Min. 150ms	↓		
Page Select	0xFF	0x01		↓	0x15	CMD2, Page0 is selected.
Reload CMD	0xFB	0x01		↓	0x15	Don't reload MTP
RD_CMDSTATUS	0xFE	Read value		↓	0x06	- Expected Return value = '0x02'
MTP_CTRL6	0x43	0x20		↓	0x15	Set Margin Read
(Read each register value for check)						※ If all data is not good, re-execute MTP Write
- Reset Active	RESX = 'Low'			↓		
- Wait		-	Min. 10us	↓		
- Reset Release	RESX = 'High'			↓		
- Wait		-	Min. 20ms	↓		
EXIT_SLEEP_MODE	0x11	-		↓	0x05	Sleep out
- Wait			Min. 120ms	↓		

Page Select	0xFF	0x01		↓	0x15	CMD2, Page0 is selected.
MTP_CTRL2	0x3F	Read value		↓	0x15	- Expected return value = '0x70'
(Read each register value for check)				↓		※ If all data is not good, re-execute MTP Write
Page leave	0xFF	0x00		↓	0x15	CMD1 is selected.
ENTER_SLEEP_MODE	0x10		Min. 100ms	↓	0x05	Sleep in
- Host Display Data Transfer	STOP			LP11 State		Image Write (Send Video Stream Packet) Stop
- Wait	-	-	Min. 100ms	↓		
- Reset Active	RESX = 'Low'			LP00 State		
- Wait			Min. 10ms	↓		
- Power Supply AVEE	AVEE OFF			↓		
- Wait	-	-	Min. 0ms	↓		
- Power Supply AVDD	AVDD OFF			↓		
- Wait	-	-	Min. 0ms	↓		
- Power Supply VDDI	VDDI OFF			LP00 State		

### 9-5 Gamma Table

Gamma setting value which shows the "Gamma2.2" characteristic in the light source "DL65" is shown below.

Item	Addresses	Gamma 2.2
1	Page Select CMD2,Page0	0xFF 0x01
2	Don't reload MTP	0xFB 0x01
3	Gamma R+	0x75 0x00
4		0x76 0x5F
5		0x77 0x00
6		0x78 0x97
7		0x79 0x00
8		0x7A 0xA1
9		0x7B 0x00
10		0x7C 0xB8
11		0x7D 0x00
12		0x7E 0xCC
13		0x7F 0x00
14		0x80 0xE2
15		0x81 0x00
16		0x82 0xEC
17		0x83 0x00
18		0x84 0xF9
19		0x85 0x01
20		0x86 0x08
21		0x87 0x01
22		0x88 0x2F
23		0x89 0x01
24		0x8A 0x50
25		0x8B 0x01
26		0x8C 0x8E
27		0x8D 0x01
28		0x8E 0xB6
29		0x8F 0x01
30		0x90 0xFD
31		0x91 0x02
32		0x92 0x2E
33		0x93 0x02
34		0x94 0x2E
35		0x95 0x02
36		0x96 0x5E
37		0x97 0x02
38		0x98 0x94
39		0x99 0x02
40		0x9A 0xB4
41		0x9B 0x02
42		0x9C 0xDB
43		0x9D 0x02
44		0x9E 0xFD
45		0x9F 0x03
46		0xA0 0x24
47		0xA1
48		0xA2 0x03

Item	Address	Gamma 2.2
49	0xA3	0x30
50	0xA4	0x03
51	0xA5	0x3C
52	0xA6	0x03
53	0xA7	0x5B
54	0xA8	
55	0xA9	0x03
56	0xAA	0x80
57	0xAB	0x03
58	0xAC	0xA3
59	0xAD	0x03
60	0xAE	0xB1
61	0xAF	0x03
62	0xB0	0xBE
63	0xB1	0x03
64	0xB2	0xBD
65	Gamma R-	0xB3 0x00
66		0xB4 0xD9
67		0xB5 0x01
68		0xB6 0x0D
69		0xB7 0x01
70		0xB8 0x13
71		0xB9 0x01
72		0xBA 0x26
73		0xBB 0x01
74		0xBC 0x3A
75		0xBD 0x01
76		0xBE 0x4F
77		0xBF 0x01
78		0xC0 0x5A
79		0xC1 0x01
80		0xC2 0x66
81		0xC3 0x01
82		0xC4 0x6B
83		0xC5 0x01
84		0xC6 0x97
85		0xC7 0x01
86		0xC8 0xB1
87		0xC9 0x01
88		0xCA 0xE8
89		0xCB 0x02
90		0xCC 0x0C
91		0xCD 0x02
92		0xCE 0x48
93		0xCF 0x02
94		0xD0 0x7E
95		0xD1 0x02
96		0xD2 0x7E

Item	Addresses	Gamma	Item	Address	Gamma		
		2.2			2.2		
97	0xD3	0x02	145	0x03	0xE6		
98	0xD4	0xAE	146	0x04	0x00		
99	0xD5	0x02	147	0x05	0xF9		
100	0xD6	0xE4	148	0x06	0x01		
101	0xD7	0x03	149	0x07	0x2C		
102	0xD8	0x03	150	0x08	0x01		
103	0xD9	0x03	151	0x09	0x4F		
104	0xDA	0x33	152	0x0A	0x01		
105	0xDB	0x03	153	0x0B	0x86		
106	0xDC	0x57	154	0x0C	0x01		
107	0xDD	0x03	155	0x0D	0xB3		
108	0xDE	0x83	156	0x0E	0x01		
109	0xDF	0x03	157	0x0F	0xFC		
110	0xE0	0x8D	158	0x10	0x02		
111	0xE1	0x03	159	0x11	0x2E		
112	0xE2	0x99	160	0x12	0x02		
113	0xE3	0x03	161	0x13	0x2E		
114	0xE4	0xB7	162	0x14	0x02		
115	0xE5	0x03	163	0x15	0x5D		
116	0xE6	0xCF	164	0x16	0x02		
117	0xE7	0x03	165	0x17	0x92		
118	0xE8	0xD8	166	0x18	0x02		
119	0xE9	0x03	167	0x19	0xB2		
120	0xEA	0xE6	168	0x1A	0x02		
121	0xEB	0x03	169	0x1B	0xDC		
122	0xEC	0xE8	170	0x1C	0x02		
123	0xED	0x03	171	0x1D	0xFF		
124	0xEE	0xEA	172	0x1E	0x03		
125	Gamma G+	0xEF	0x00	173	0x1F	0x27	
126		0xF0	0x2D	174	0x20	0x03	
127		0xF1	0x00	175	0x21	0x3B	
128		0xF2	0x71	176	0x22	0x03	
129		0xF3	0x00	177	0x23	0x45	
130		0xF4	0x87	178	0x24	0x03	
131		0xF5	0x00	179	0x25	0x63	
132		0xF6	0xA1	180	0x26	0x03	
133		0xF7	0x00	181	0x27	0x77	
134		0xF8	0xB2	182	0x28	0x03	
135		0xF9	0x00	183	0x29	0x95	
136		0xFA	0xCB	184	0x2A	0x03	
137		0xFB	0x01	185	0x2B	0x9E	
138	Page Select CMD1	0xFF	0x00	186	0x2C		
139	Don't reload MTP	0xFB	0x01	187	0x2D	0x03	
140	Page Select CMD2,Page1	0xFF	0x02	188	0x2E		
141	Don't reload MTP	0xFB	0x01	189	0x2F	0xA4	
142		0x00	0x00	190	0x30	0x03	
143		0x01	0xD7	191	0x31	0xBC	
144		0x02	0x00	192	Gamma G-	0x32	0x00

Item	Address	Gamma	Item	Address	Gamma	
		2.2			2.2	
193	0x33	0xB2	241	0x63	0x03	
194	0x34	0x00	242	0x64	0xA1	
195	0x35	0xF1	243	0x65	0x03	
196	0x36	0x00	244	0x66	0xC0	
197	0x37	0xFC	245	0x67	0x03	
198	0x38	0x01	246	0x68	0xD4	
199	0x39	0x13	247	0x69	0x03	
200	0x3A	0x01	248	0x6A	0xDD	
201	0x3B	0x21	249	0x6B	0x03	
202	0x3C		250	0x6C	0xE3	
203	0x3D	0x01	251	0x6D	0x03	
204	0x3E		252	0x6E	0xE7	
205	0x3F	0x37	253	0x6F	0x03	
206	0x40	0x01	254	0x70	0xEA	
207	0x41	0x44	255	Gamma B+	0x71	0x00
208	0x42	0x01	256		0x72	0x5F
209	0x43	0x51	257		0x73	0x00
210	0x44	0x01	258		0x74	0x97
211	0x45	0x65	259		0x75	0x00
212	0x46	0x01	260		0x76	0xA1
213	0x47	0x8A	261		0x77	0x00
214	0x48	0x01	262		0x78	0xB6
215	0x49	0xA8	263		0x79	0x00
216	0x4A	0x01	264		0x7A	0xC6
217	0x4B	0xF2	265		0x7B	0x00
218	0x4C	0x02	266		0x7C	0xD9
219	0x4D	0x0B	267		0x7D	0x00
220	0x4E	0x02	268		0x7E	0xE2
221	0x4F	0x48	269		0x7F	0x00
222	0x50	0x02	270		0x80	0xF1
223	0x51	0x7E	271		0x81	0x00
224	0x52	0x02	272		0x82	0xFD
225	0x53	0x7E	273		0x83	0x01
226	0x54	0x02	274		0x84	0x26
227	0x55	0xAD	275		0x85	0x01
228	0x56	0x02	276		0x86	0x45
229	0x57		277		0x87	0x01
230	0x58	0xE4	278		0x88	0x83
231	0x59	0x03	279		0x89	0x01
232	0x5A	0x06	280		0x8A	0xAF
233	0x5B	0x03	281		0x8B	0x01
234	0x5C	0x35	282		0x8C	0xF7
235	0x5D	0x03	283		0x8D	0x02
236	0x5E	0x59	284		0x8E	0x21
237	0x5F	0x03	285		0x8F	0x02
238	0x60	0x80	286		0x90	0x21
239	0x61	0x03	287		0x91	0x02
240	0x62	0x93	288		0x92	0x5A

Item	Addresses	Gamma
		2.2
289	0x93	0x02
290	0x94	0x90
291	0x95	0x02
292	0x96	0xB1
293	0x97	0x02
294	0x98	0xDB
295	0x99	0x02
296	0x9A	0xF7
297	0x9B	0x03
298	0x9C	0x1E
299	0x9D	0x03
300	0x9E	0x29
301	0x9F	0x03
302	0xA0	0x37
303	0xA1	
304	0xA2	0x03
305	0xA3	0x56
306	0xA4	0x03
307	0xA5	0x79
308	0xA6	0x03
309	0xA7	0x99
310	0xA8	
311	0xA9	0x03
312	0xAA	0xA7
313	0xAB	0x03
314	0xAC	0xB9
315	0xAD	0x03
316	0xAE	0xBD
317	Gamma B-	0x00
318	0xB0	0xD9
319	0xB1	0x01
320	0xB2	0x0C
321	0xB3	0x01
322	0xB4	0x13
323	0xB5	0x01
324	0xB6	0x26
325	0xB7	0x01
326	0xB8	0x33
327	0xB9	0x01
328	0xBA	0x45
329	0xBB	0x01
330	0xBC	0x50
331	0xBD	0x01
332	0xBE	0x5D
333	0xBF	0x01
334	0xC0	0x69
335	0xC1	0x01
336	0xC2	0x8E

Item	Address	Gamma
		2.2
337	0xC3	0x01
338	0xC4	0xA8
339	0xC5	0x01
340	0xC6	0xDC
341	0xC7	0x02
342	0xC8	0x04
343	0xC9	0x02
344	0xCA	0x43
345	0xCB	0x02
346	0xCC	0x87
347	0xCD	0x02
348	0xCE	0x87
349	0xCF	0x02
350	0xD0	0xAA
351	0xD1	0x02
352	0xD2	0xE4
353	0xD3	0x03
354	0xD4	0x05
355	0xD5	0x03
356	0xD6	0x2E
357	0xD7	0x03
358	0xD8	0x51
359	0xD9	0x03
360	0xDA	0x76
361	0xDB	0x03
362	0xDC	0x83
363	0xDD	0x03
364	0xDE	0x8F
365	0xDF	0x03
366	0xE0	0xB2
367	0xE1	0x03
368	0xE2	0xDA
369	0xE3	0x03
370	0xE4	0xE4
371	0xE5	0x03
372	0xE6	0xE6
373	0xE7	0x03
374	0xE8	0xE8
375	0xE9	0x03
376	0xEA	0xEA
377	Page select (CMD1)	0xFF
378		0x01

10. Optical Characteristics

Ta=25°C

Item	Symbol	Condition	Min	Typ.	Max.	Unit	Remark
View Angles	Θ11	CR ≥ 10	70	80	-	Degree	Note10-1
	Θ12		70	80	-		
	Θ21		70	80	-		
	Θ22		70	80	-		
Contrast Ratio	CR	θ=0° Center	500	1000	-		Note 10-1 Note 10-2
Response Time	T <sub>ON</sub>	25°C	-	21	35	ms	Note 10-3
	T <sub>OFF</sub>						
Chromaticity	WHITE	x	0.264	0.294	0.324		
		y	0.305	0.335	0.365		
	RED	x	0.620	0.650	0.680		
		y	0.298	0.328	0.358		
	GREEN	x	0.288	0.318	0.348		
		y	0.576	0.606	0.636		
	BLUE	x	0.120	0.150	0.180		
		y	0.035	0.065	0.095		
Uniformity	U		80	85	-	%	Note 10-5
NTSC	S		-	70	-	%	
Luminance	L	Center	550	650	-	cd/m <sup>2</sup>	Note 10-4

\*The measuring method of the optical characteristics is shown by the following figure.

\*A measurement device is TOPCON luminance meter SR-3. (Measurement angle: 1 degree.)

Photodetector(including luminosity factor)

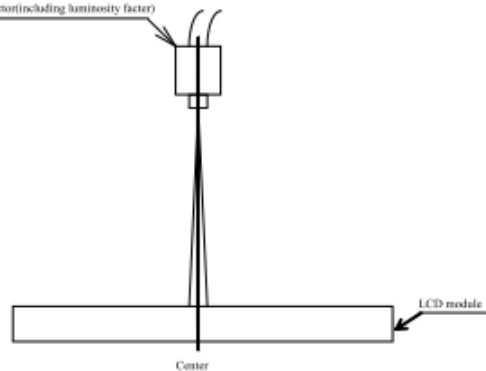

Measuring method for optical characteristics

Note 10-1: Contrast / Viewing angle is defined as follows.



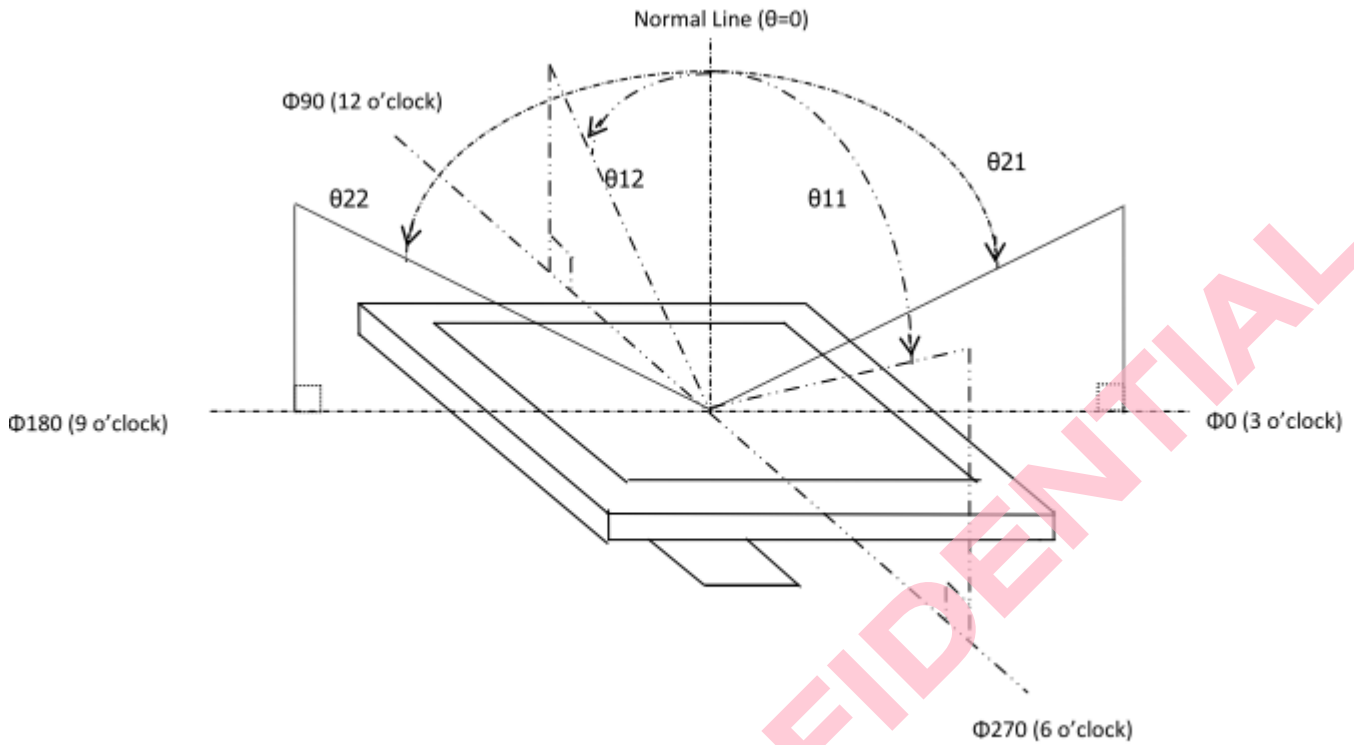

Note 10-2: Definition of contrast ratio:

The contrast ratio is defined as the follows:

$$\text{Contrast ratio (CR)} = \frac{\text{Luminance (brightness) with all pixels white}}{\text{Luminance (brightness) with all pixels black}}$$

Note 10-3: Definition of response time:

The response time is defined as the following figure and shall be measured by switching the input signal for "black" and "white"

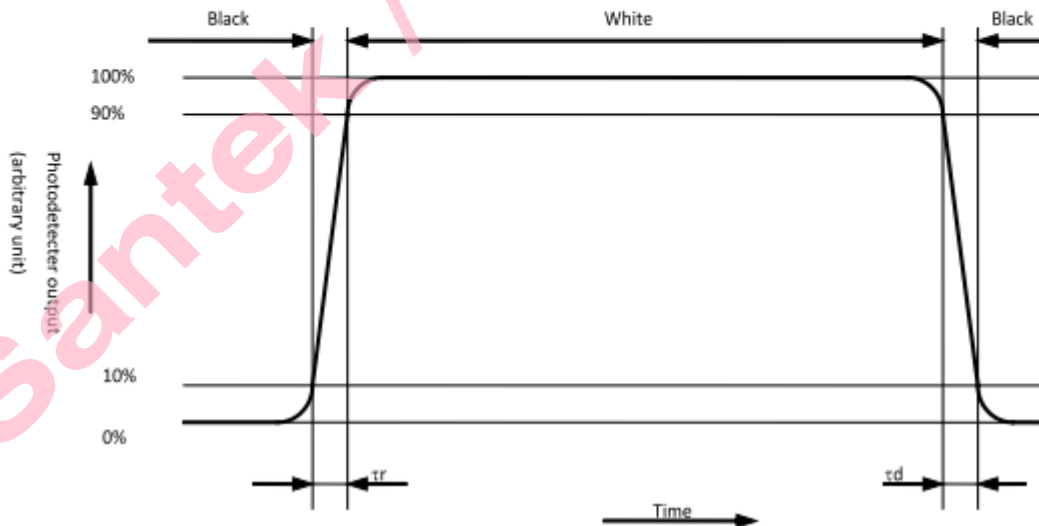

Note 10-4 Measurement Position and Point

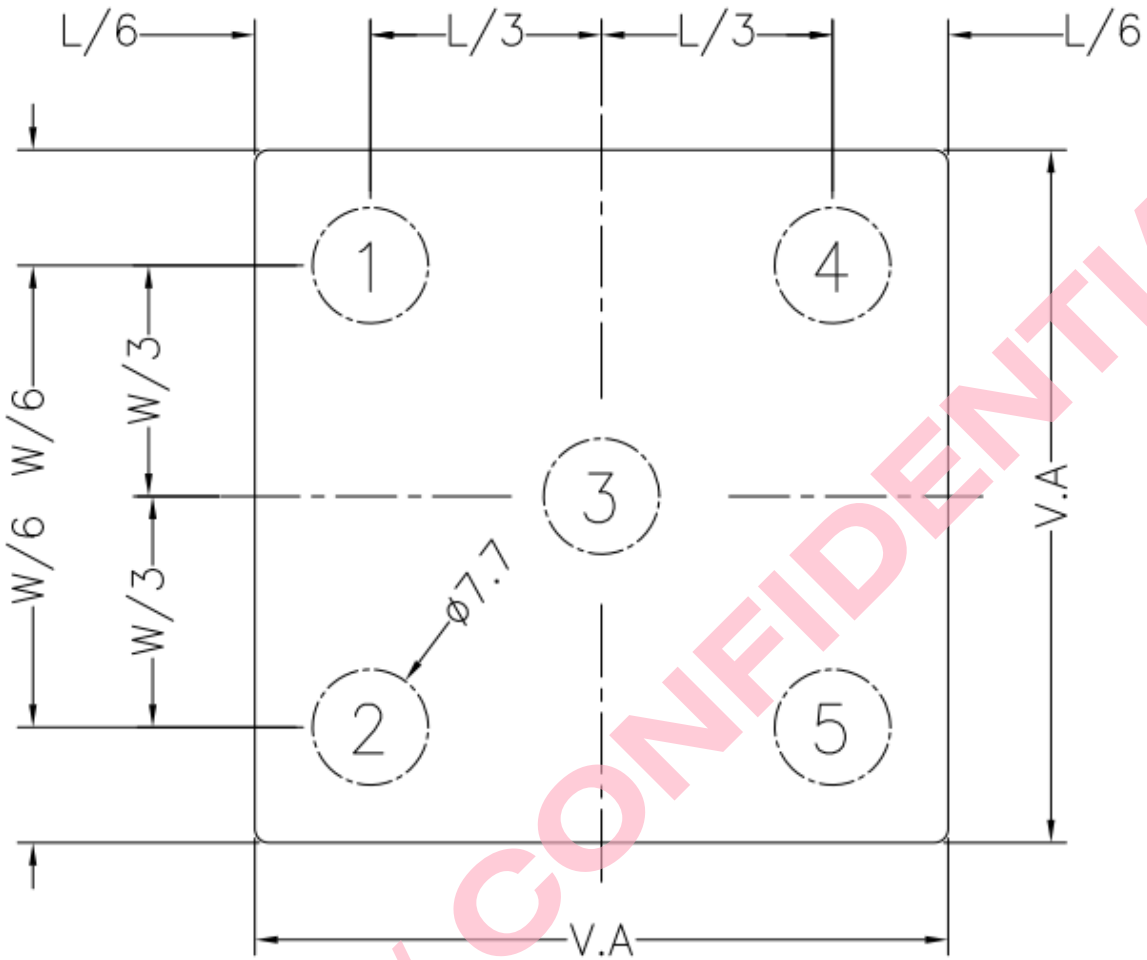

Note 10-5 Uniformity

(Min brightness / Max brightness) x 100%

11. Environmental / Reliability Tests

No	Test Item	Condition	Remarks
1	High Temperature Operation	Ts=+70°C, 240hrs	Note 1 IEC60068-2-2, GB2423.2—89
2	Low Temperature Operation	Ta=-20°C, 240hrs	Note 2 IEC60068-2-1, GB2423.1—89
3	High Temperature Storage	Ta=+80°C, 240hrs	IEC60068-2-2, GB2423.2—89
4	Low Temperature Storage	Ta=-30°C, 240hrs	IEC60068-2-1, GB2423.1—89
5	High Temperature & High Humidity Storage	+40°C, 95% RH max, 240 hours (No condensation)	IEC60068-2-3, GB/T2423.3—2006
6	Thermal Shock (Non-operation)	-30°C(30 min)~+80°C(30min) 50 Cycle.	Start with cold temperature, end with high temperature IEC60068-2-14, GB2423.22—87
7	Electro Static Discharge (Operation)	(Test at the center of surface) 150pF,330Ω±10KV Contact 150pF,330Ω±15KV Air	IEC61000-4-2 GB/T17626.2—1998
8	Vibration (Non-operation)	Frequency Range: 10~55Hz, Stroke: 1.5mm Sweep: 10Hz~55Hz~10Hz 2hours for each direction of X.Y.Z. (package condition)	IEC60068-2-6 GB/T2423.10—1995
9	Shock (Non-operation)	100G 6ms, ±X, ±Y, ±Z 1 times for each direction	IEC60068-2-6 GB/T2423.5—1995
10	Package Drop Test	1corner, 3edges, 6surfaces	IEC60068-2-32 GB/T2423.8—1995

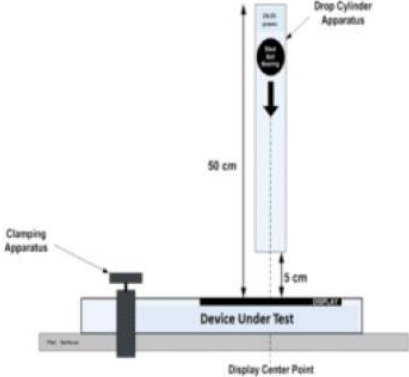
<p>11</p>	<p><b>Ball drop test</b></p> 	<p>Test requirements: A ball bearing approximately 32.5 Grams          Test Procedure: Place the LCD on a flat platform where the LCD is not moving or it can be clamped from the ends. The diagram below is a suggested placement diagram and an apparatus. Drop the ball bearing from the height of 50 cm directly to the center of the LCD. 1 times the product will not break as qualified.</p> <p>Hint: The ball bearing can be dropped via a tube to ensure a straight drop in the center of the LCD.</p>
-----------	--	---

Note 1:  $T_s$  is the temperature of panel's surface.

Note 2:  $T_a$  is the ambient temperature of sample.

12. Packing drawing

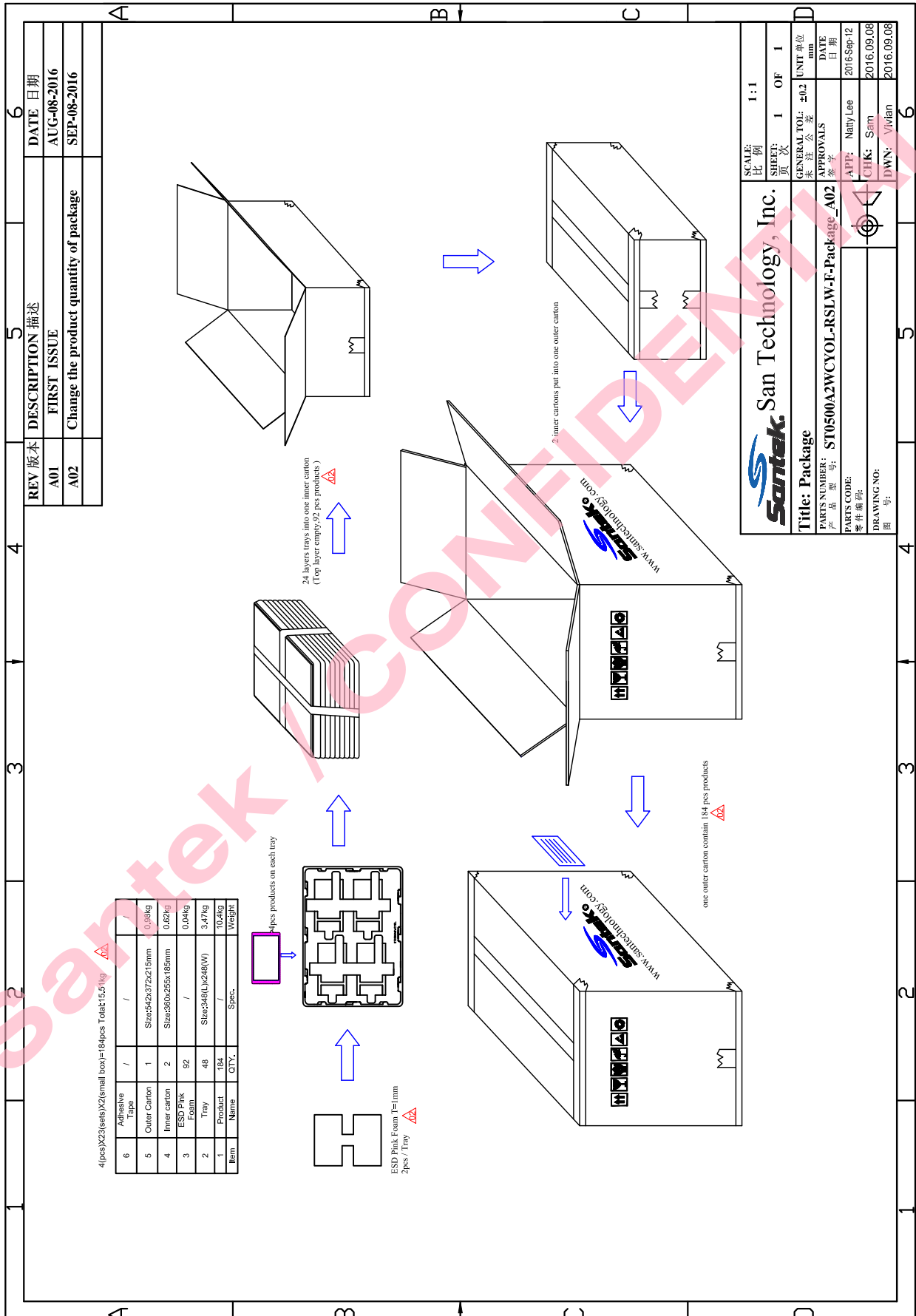

### 13.Incoming Inspection Standards

#### 13.1 Acceptable quality level ("AQL")

The AQL for major and minor defects shall be respectively set forth below.

- a) Major defects : AQL 0.4
- b) Minor defects : AQL 1.0      Based on overall evaluation

#### 13.2 Inspection conditions

Item	Inspection conditions
	Reflection inspection
Ambient illumination	300~700lx
Ambient temperature	18~27°C
Ambient Humidity	50~85%RH
Viewing distance	350mm ± 50mm
Direction of lighting	Set light tube with reflection on the panel surface
Viewing angle	The surface of the Module and the eyes of the inspector shall be 90±5 degrees.
Check pattern(Bright dot)	Black picture position
Check pattern(Black dot)	White & RGB picture position

#### 13.3 Definition

No	Item	Definition
a	Dot	Pixel
		3 sub-pixels (R+G+B)
b	Bright dot	Dot
		1 sub-pixel (R or G or B)
b	Bright dot	A dot, a foreign particle seen as a bright dot, and a CF scratch with a brightness higher than the gray scale levels specified below, visible on the full black pattern. Gray scale level: R:brightness>V150/255, G:brightness>V116/255, B:brightness>V165/255
c	Black dot	When the Module lights, dot appear black in display at White& RGB picture position.
d	Tiny bright dot	The gray scale level of R:brightness≤V150/255, G:brightness≤V116/255, B:brightness≤V165/255

- Scratch that is located in the active area shall be judged according to the criteria for "Bright dot".
- CF scratch shall be judged according to the criteria for "Bright dot".

13.4 Acceptable dot defects (Bright dot, Black dot)

		Number of dot defects
Bright dot		3
Foreign particles seen as bright dot		
Tiny bright dot		Ignore
Black dot	1 dot	4
	2 adjacent dots	
	3 adjacent dots	0
Total (Black dots)		5

13.5 Defect distance

Item		Inspection criteria
Defect distance	Black dots	5mm or more
Adjacent dots	Black dots	Two adjacent black dots shall be count as 1 black dot. It shall be allowed according to 13.4 Adjacent bright dots shall be allowed, in case the brightness is equal or lower than the brightness of the gray levels specified in 13.3b
	Bright dots	

13.6 Cosmetic & appearance inspection

No.	Defect Description	Acceptable Criteria			Remark	
		Size (mm)	Number	Distance		
1	Polarizer Dent or Bubble	$D \leq 0.1$	Ignore	Ignore		
		$0.1 < D \leq 0.2$	$N \leq 5$	$\geq 5\text{mm}$		
		$0.2 < D \leq 0.3$	$N \leq 3$	$\geq 5\text{mm}$		
		$0.3 < D \leq 0.4$	$N \leq 1$	$\geq 5\text{mm}$		
		$D > 0.4$	NG	NG		
2	Circular Defects (e.g. particle or OCA bubble)	$D \leq 0.15$	Ignore	Ignore		
		$0.15 < D \leq 0.3$	$N \leq 3$	$\geq 5\text{mm}$		
		$0.3 < D \leq 0.35$	$N \leq 2$	$\geq 5\text{mm}$		
		$D > 0.35$	NG	NG		
3	Linera Defects (e.g. fiber)	$W \leq 0.05$	Ignore	Ignore		
		$0.05 < W \leq 0.1$	$L \leq 6.0$	$N \leq 3$	$\geq 5\text{mm}$	
		$W > 0.1$	$L > 5.0$	NG	NG	
4	Dent/Fisheye	Follow the limit sample.				
5	Scratch	$W \leq 0.05$	Ignore	Ignore		
		$0.05 < W \leq 0.1$	$L \leq 8.0$	$N \leq 3$	$\geq 5\text{mm}$	
		$W > 0.1$	$L > 8.0$	NG	NG	
6	CG Chipping-Edge	Invisible from front side.		Ignore	Ignore	 <p>Chip on edge</p>
		$X \leq 3.0$	$Y \leq 3.0$	$N \leq 4$	$\geq 5\text{mm}$	
7	Pinhole in BM area	$D \leq 0.10$	Ignore	Ignore		
		$0.10 < D \leq 0.2$	$N \leq 2$	$\geq 5\text{mm}$		
8	BM Ink Leakage	$W \leq 0.1\text{mm}$	Ignore	$\geq 5\text{mm}$		
		$0.10 \leq W \leq 0.15$	$L \leq 10$	$N \leq 2$	$\geq 5\text{mm}$	



## 14. Precautions For Use of LCD modules

### 14.1 Handling Precautions

- 14.1.1 The display panel is made of glass. Do not subject it to a mechanical shock by dropping it from a high place, etc.
- 14.1.2 If the display panel is damaged and the liquid crystal substance inside it leaks out, be sure not to get any in your mouth, if the substance comes into contact with your skin or clothes, promptly wash it off using soap and water.
- 14.1.3 Do not apply excessive force to the display surface or the adjoining areas since this may cause the color tone to vary.
- 14.1.4 The polarizer covering the display surface of the LCD module is soft and easily scratched. Handle this polarizer carefully.
- 14.1.5 If the display surface is contaminated, breathe on the surface and gently wipe it with a soft dry cloth. If still not completely clear, moisten cloth with one of the following solvents:
  - Isopropyl alcohol
  - Ethyl alcoholSolvents other than those mentioned above may damage the polarizer. Especially, do not use the following:
  - Water
  - Ketone
  - Aromatic solvents
- 14.1.6 Do not attempt to disassemble the LCD Module.
- 14.1.7 If the logic circuit power is off, do not apply the input signals.
- 14.1.8 To prevent destruction of the elements by static electricity, be careful to maintain an optimum work environment.
  - 14.1.8.1 Be sure to ground the body when handling the LCD Modules.
  - 14.1.8.2 Tools required for assembly, such as soldering irons, must be properly ground.
  - 14.1.8.3 To reduce the amount of static electricity, do not conduct assembly and other work under dry conditions.
  - 14.1.8.4 The LCD Module is coated with a film to protect the display surface. Be care when peeling off this protective film since static electricity may be generated.

## 14.2 Storage Precautions

14.2.1 When storing the LCD modules, avoid exposure to direct sunlight or to the light of fluorescent lamps.

14.2.2 The LCD modules should be stored under the storage temperature range. If the LCD modules will be stored for a long time, the recommend condition is:

Temperature: 0°C ~ 40°C    Relatively humidity:  $\leq 80\%$

14.2.3 The LCD modules should be stored in the room without acid, alkali and harmful gas.

## 14.3 Transportation Precautions

The LCD modules should be no falling and violent shocking during transportation, and also should avoid excessive press, water, damp and sunshine.

## 14.4 Mechanical design

This LCM is very thin and narrow edge, Santek recommends there is some support from back side of LCM in customer's assembly.