

## SS8050-HF (NPN)

RoHS Device  
Halogen Free

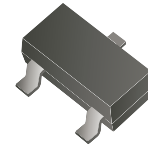

### Mechanical Data

- Case: SOT-23, molded plastic.
- Mounting position: Any.

### Circuit Diagram

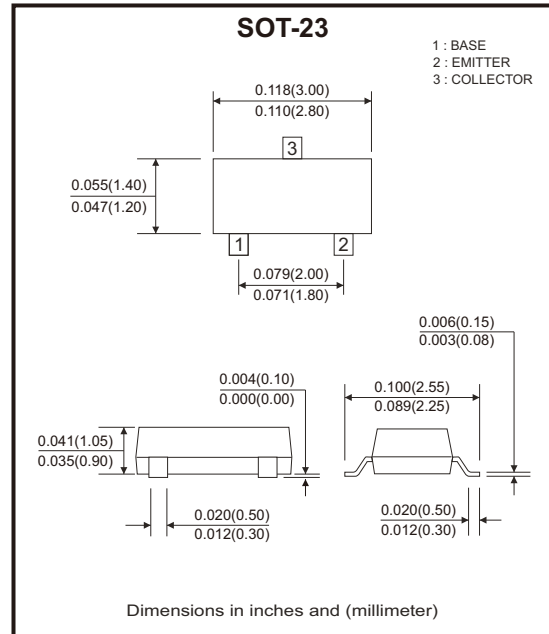
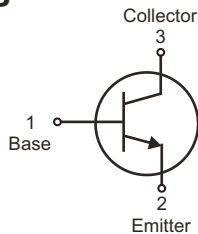

### Maximum Ratings (at $T_A=25^\circ\text{C}$ unless otherwise noted)

Parameter	Symbol	Value	Unit
Collector-Base voltage	$V_{CB0}$	40	V
Collector-Emitter voltage	$V_{CE0}$	25	V
Emitter-Base voltage	$V_{EB0}$	5	V
Collector current	$I_C$	1.5	A
Collector power dissipation	$P_C$	300	mW
Thermal resistance from junction to ambient	$R_{\theta JA}$	417	$^\circ\text{C/W}$
Operation junction and storage temperature range	$T_J, T_{STG}$	-55 to +150	$^\circ\text{C}$

### Electrical Characteristics (at $T_A=25^\circ\text{C}$ unless otherwise noted)

Parameter	Conditions	Symbol	Min	Typ	Max	Unit
Collector-Base breakdown voltage	$I_C=100\mu\text{A}, I_E=0$	$V_{(BR)CBO}$	40			V
Collector-Emitter breakdown voltage	$I_C=0.1\text{mA}, I_B=0$	$V_{(BR)CEO}$	25			V
Emitter-Base breakdown voltage	$I_E=100\mu\text{A}, I_C=0$	$V_{(BR)EBO}$	5			V
Collector cut-off current	$V_{CB}=40\text{V}, I_E=0$	$I_{CBO}$			0.1	$\mu\text{A}$
Collector cut-off current	$V_{CE}=20\text{V}, I_E=0$	$I_{CEO}$			0.1	$\mu\text{A}$
Emitter cut-off current	$V_{EB}=5\text{V}, I_C=0$	$I_{EBO}$			0.1	$\mu\text{A}$
DC current gain	$V_{CE}=1\text{V}, I_C=100\text{mA}$	$h_{FE(1)}$	200		350	
	$V_{CE}=1\text{V}, I_C=800\text{mA}$	$h_{FE(2)}$	40			
Collector-Emitter saturation voltage	$I_C=800\text{mA}, I_B=80\text{mA}$	$V_{CE(sat)}$			0.5	V
Base-Emitter saturation voltage	$I_C=800\text{mA}, I_B=80\text{mA}$	$V_{BE(sat)}$			1.2	V
Transition frequency	$V_{CE}=10\text{V}, I_C=50\text{mA}, f=30\text{MHz}$	$f_T$	100			MHz

## Rating and Characteristic Curves (SS8050-HF)

Fig.1 - Static Characteristic

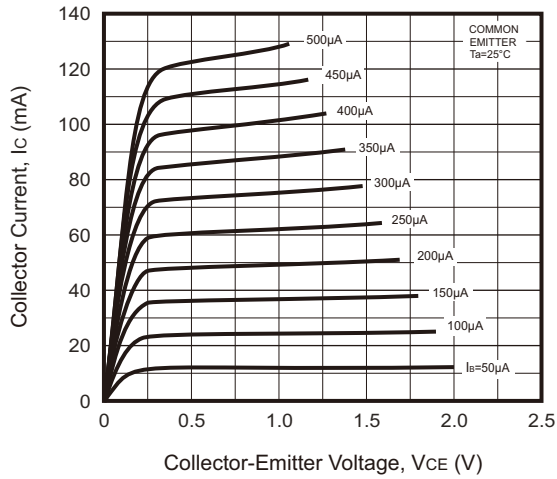

Fig.2 -  $h_{FE} - I_c$

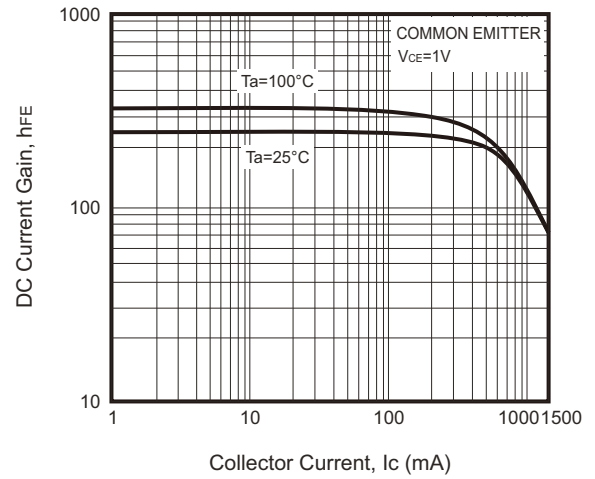

Fig.3 -  $V_{CEsat} - I_c$

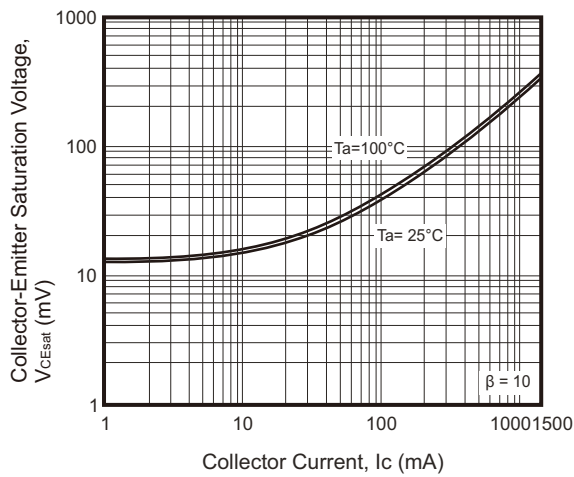

Fig.4 -  $V_{BEsat} - I_c$

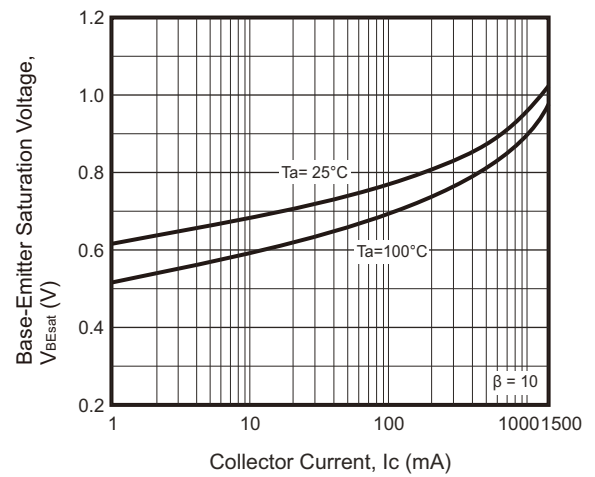

Fig.5 -  $V_{BE} - I_c$

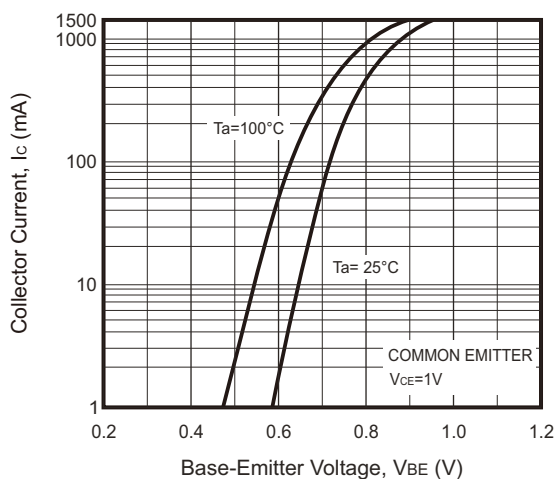
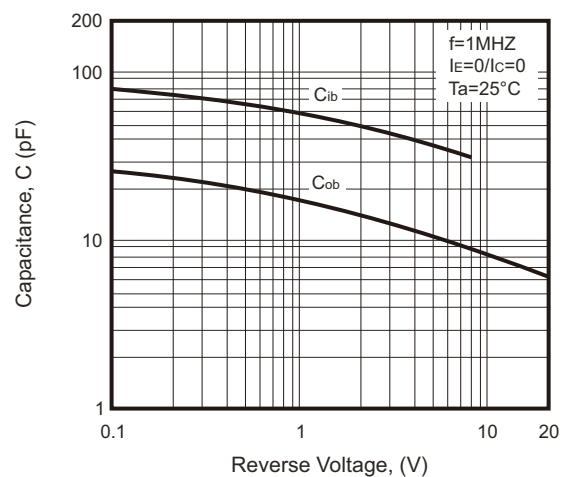

Fig.6 -  $C_{ob}/C_{ib} - V_{CB}/V_{EB}$



## Rating and Characteristic Curves (SS8050-HF)

Fig.7 -  $f_T$  —  $I_C$

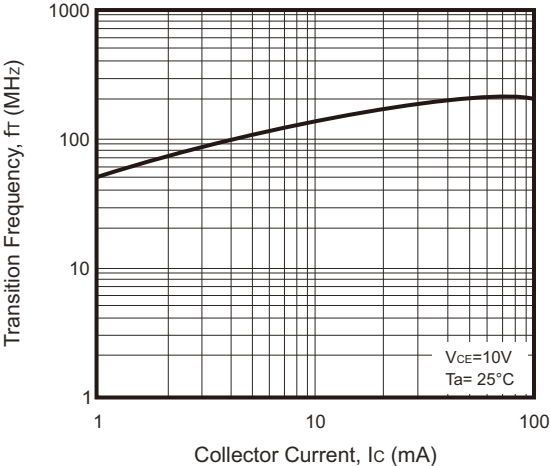
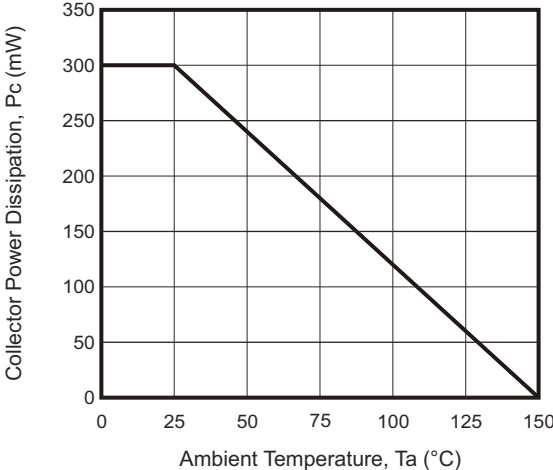
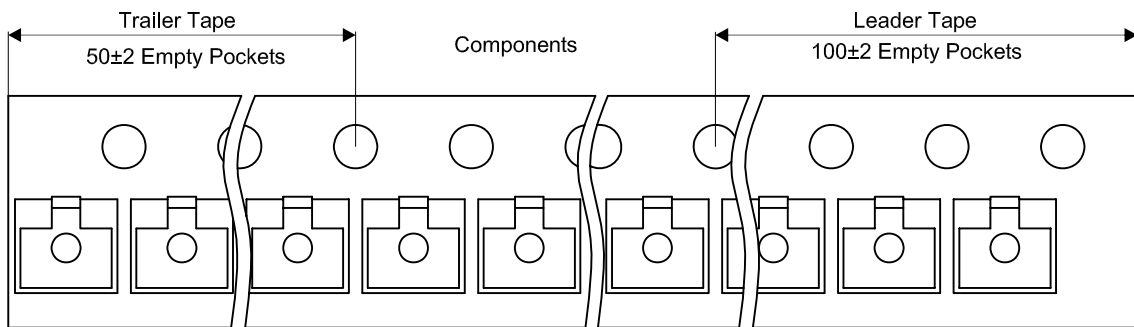
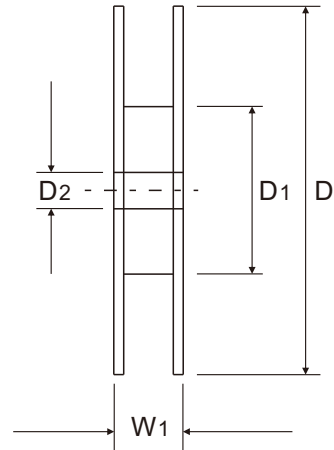
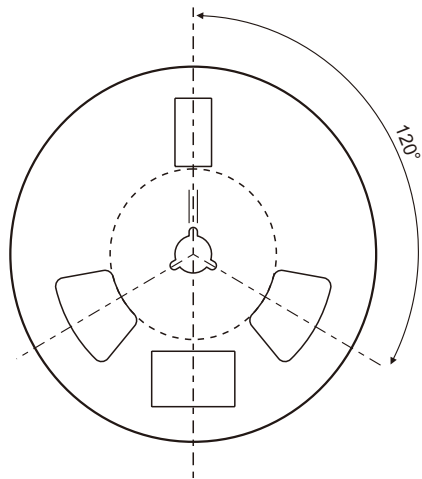
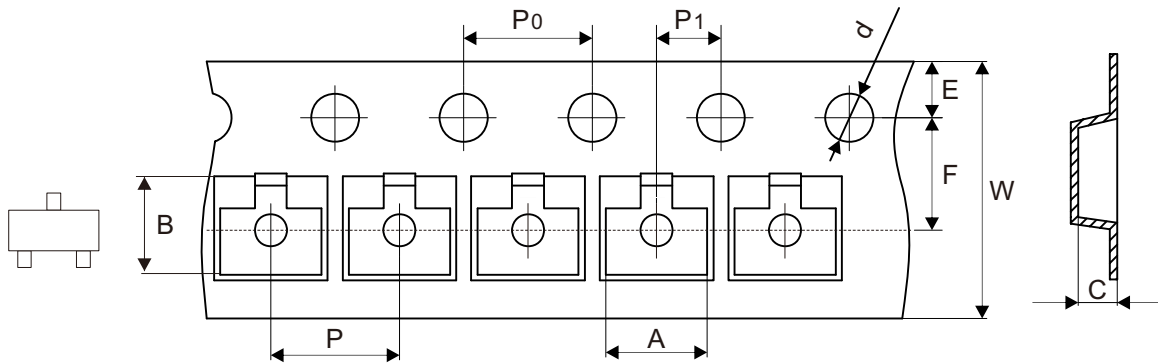

Fig.8 -  $P_C$  —  $T_A$



## Reel Taping Specification



SOT-23	SYMBOL	A	B	C	d	D	D1	D2
	(mm)	3.15 ± 0.10	2.77 ± 0.10	1.22 ± 0.10	1.50 ± 0.10	178.00 ± 2.00	54.40 ± 1.00	13.00 ± 1.00
	(inch)	0.124 ± 0.004	0.109 ± 0.004	0.048 ± 0.004	0.059 ± 0.004	7.008 ± 0.079	2.142 ± 0.039	0.512 ± 0.039

SOT-23	SYMBOL	E	F	P	P0	P1	W	W1
	(mm)	1.75 ± 0.10	3.50 ± 0.10	4.00 ± 0.10	4.00 ± 0.10	2.00 ± 0.10	8.00 + 0.30 - 0.10	12.30 ± 1.00
	(inch)	0.069 ± 0.004	0.138 ± 0.004	0.157 ± 0.004	0.157 ± 0.004	0.079 ± 0.004	0.315 + 0.012 - 0.004	0.484 ± 0.039

## Marking Code

Part Number	Marking Code
SS8050-HF	Y1

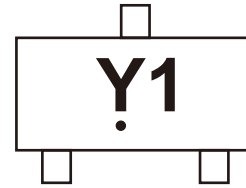

Solid dot = Control code

## Suggested P.C.B. PAD Layout

SIZE	SOT-23	
	(mm)	(inch)
A	0.90	0.035
B	0.80	0.031
C	0.95	0.037
D	2.00	0.079
E	2.90	0.114

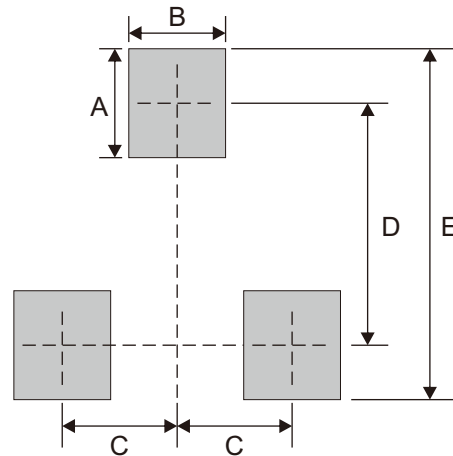

## Standard Packaging

Case Type	REEL PACK	
	REEL (pcs)	Reel Size (inch)
SOT-23	3,000	7