



Evaluation kit for General purpose Bluetooth™ Modules Datasheet

GENERAL DESCRIPTION

>> F2M03G-KIT is a new evaluation kit for Free2move's general-purpose Bluetooth modules. The evaluation board has extensive I/O functionality for both data and audio streams. The evaluation board is primarily made to evaluate the Wireless UART firmware but is also intended to be used for other firmwares and custom made applications. The evaluation board gives the possibility to upgrade the Bluetooth module with new firmware using Free2move's Flash utility.

>> The F2M03G-KIT has both RS232 and USB-interface for data communication. The USB-interface can either act as a direct connection to the module through HCI or it can be used as a virtual com port for computers without a physical com port. All digital and analog I/O:s can be accessed from pin headers on the evaluation board for external communication.

>> The evaluation board is equipped with an audio codec and amplifier for direct microphone and speaker drive. External audio streams can be connected using the PCM interface.

>> The F2M03G-KIT is delivered with all necessary cables and a CD with manuals and software. The evaluation kit can both be delivered as a single or a double kit. The kit does NOT include any Bluetooth OEM-board. They are ordered separately!

KEY FEATURES

- >> 10 GPIO:s with push buttons and led indication
- >> Analog audio interface (mono)
(speaker and microphone, 3.5mm socket)
- >> Power supply through USB-connector or external adaptor
- >> USB-interface (virtual com port or direct HCI access)
- >> RS232-interface
- >> Programming interface for Free2move's flash utility (parallel port)
- >> Pin headers for all digital and analog I/O:s



Image of the Evaluation board with a F2M03GLA module

F2M03G-KIT-1 CONTAINS

- >> F2M02BG1 (Evaluation board)
- >> USB-cable
- >> Serial cable
- >> Parallel cable
- >> CD (Manuals and software)

ORDER INFORMATION

- >> Evaluation kit:
 - > F2M03G-KIT-1
- >> Bluetooth OEM-board:
 - > F2M02GLA-S01 (OEM-board with a F2M03GLA module and Wireless UART firmware)
 - > F2M02GX-S01 (OEM-board with a F2M03GX module and Wireless UART firmware)
 - > F2M02GXA-S01 (OEM-board with a F2M03GXA module and Wireless UART firmware)
- >> Bluetooth OEM-board with pin sockets:
 - > F2M02GLA-S01-K (OEM-board with F2M03GLA module, Wireless UART firmware and pin socket)
 - > F2M02GX-S01-K (OEM-board with F2M03GX module, Wireless UART firmware, pin socket and antenna)
 - > F2M02GXA-S01-K (OEM-board with F2M03GXA module, Wireless UART firmware and pin socket)



BLUETOOTH is a trademark owned by Bluetooth SIG, Inc., U.S.A. and licensed to Free2move



Evaluation kit for General purpose Bluetooth™ Modules

Datasheet

Table of contents

1	Package content	3
2	Quick getting started guide	4
3	Device terminal description	5
3.1	GPIO	5
3.2	UART	6
3.3	SPI	8
3.4	Power supply	9
3.5	Audio	9
3.6	Bluetooth module connector	11
3.7	Host Controlled Interface (HCI)	12
4	Layout	13
5	Schematics	14
6	Bill of materials	15
7	Ordering information	17
8	Document history	18
	Acronyms and definitions.....	19



Evaluation kit for General purpose Bluetooth™ Modules Datasheet

1 Package content

Please make sure that the package contains the following:

- Evaluation board F2M02BG1
- CD (software and user manuals)



- 1m USB-cable (USB-210)
- 2m 9pin serial cable (DEL-37)
- 2m 25pin parallel cable (DEL-20)





Evaluation kit for General purpose Bluetooth™ Modules Datasheet

2 Quick getting started guide

1. Unpack and check that all items in the package are present.
2. Gently attach the OEM-Bluetooth board on connector J18. The OEM-board should be placed so the drill hole (4mm in diameter) on both the Evaluation-kit and the OEM-board is matching each other. The antenna (or connector) on the OEM-board should point away from the evaluation board, shown in the image below.

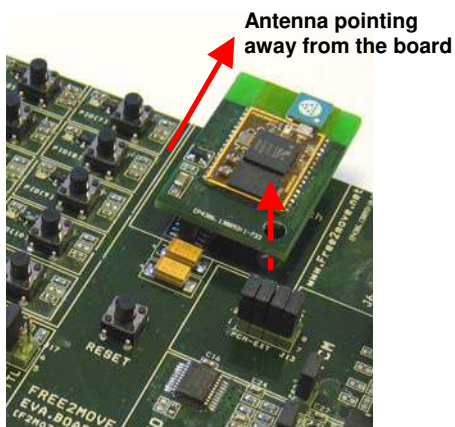

3. Connect the USB-cable provided with the kit between your computer and the evaluation board.
4. Power up the evaluation board by moving the switch SW1 to the ON-position.
5. You should now see the screen "found new hardware" (under windows XP) and the installation of the USB-to-Serial port driver for the Evaluation board begins. Please look at the documentation from FTDI for information about the driver installation.
6. Install Free2move's configuration software provided on the CD and follow the installation instructions.
7. You will now be able to configure the module with the Wireless UART firmware by using the configuration software!

The above "quick getting started guide" is only a brief explanation of how you can configure the evaluation kit. You have all possibilities to use any interface you like, connecting external devices, change the firmware on the module, change the power source etc. Feel free to use the evaluation kit to fit your application and needs!



Evaluation kit for General purpose Bluetooth™ Modules Datasheet

3 Device terminal description

All terminals available on the evaluation board are presented in this chapter. The image below is showing the different parts of the board.

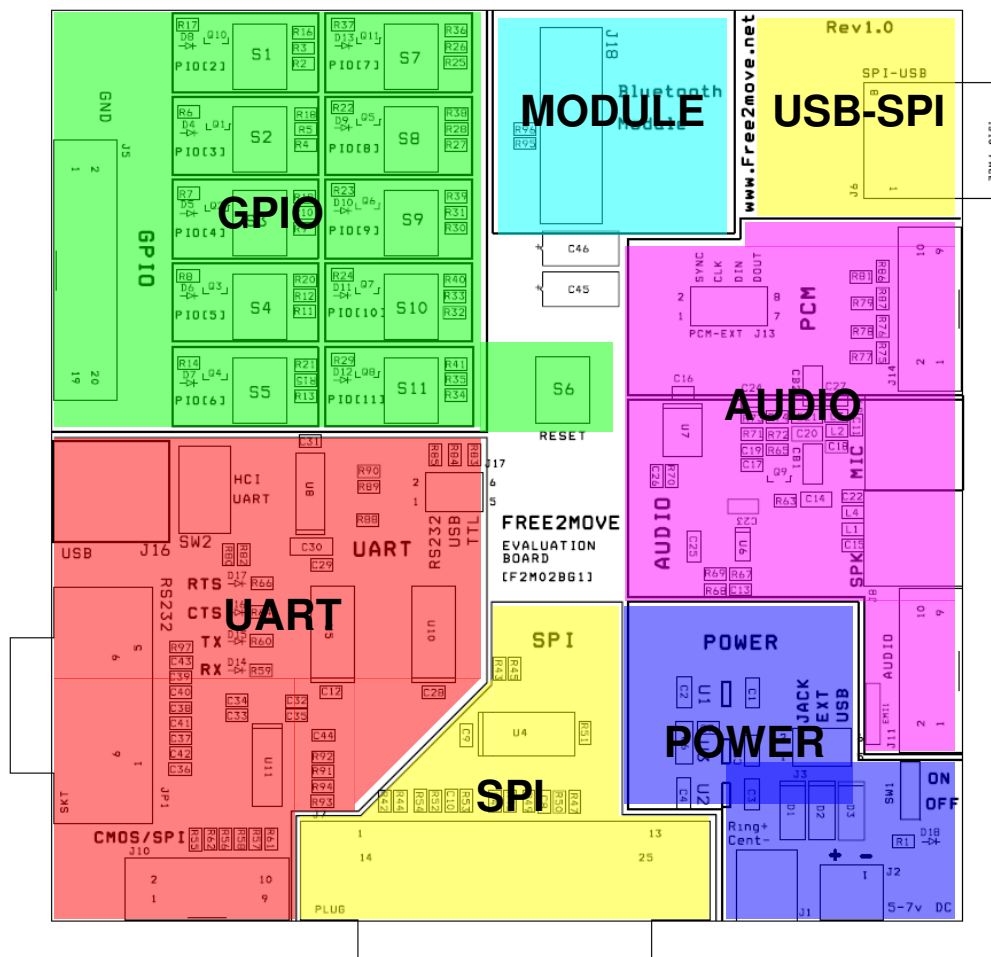

3.1 GPIO

The board is equipped with 10 pushbuttons/leds for general evaluation purposes. The buttons and leds are active high. All GPIOs from the module are also available on connector J5, which have CMOS levels (0v-3v3). The reset button is located in the middle of the board and will, if pushed down, reset the Bluetooth module. The GND-pin is directly connected to the digital ground of the board and can be used for measurement purposes.

Connector J5 pinout:

Pin	Description	Direction
1	GND	GND
2	+3v3	OUT
3	AIO[1]	I/O
4	AIO[2]	I/O
5	AIO[0]	I/O
6	AIO[3]	I/O
7	GND	GND
8	GND	GND
9	PIO[0]	I/O
10	PIO[11]	I/O

Pin	Description	Direction
11	PIO[1]	I/O
12	PIO[10]	I/O
13	PIO[2]	I/O
14	PIO[9]	I/O
15	PIO[3]	I/O
16	PIO[8]	I/O
17	PIO[4]	I/O
18	PIO[7]	I/O
19	PIO[5]	I/O
20	PIO[6]	I/O



Evaluation kit for General purpose Bluetooth™ Modules Datasheet

3.2 UART

It is possible to connect to the UART on the module in three different ways. Either via USB, RS232 or connect it directly without any level-converters (CMOS-levels). The default UART interface is USB at delivery but can easily be changed by changing the jumper on connector J17.

3.2.1 USB

The evaluation board is equipped with an USB-to-UART converter from FTDI making it possible to send UART data over the USB-interface by emulate a com-port (Presented as a Virtual Com Port on the computer). Before you install the drivers or try to communicate with the module, please make sure that J17 has a jumper attached at the USB marking and switch SW2 is in the UART position.

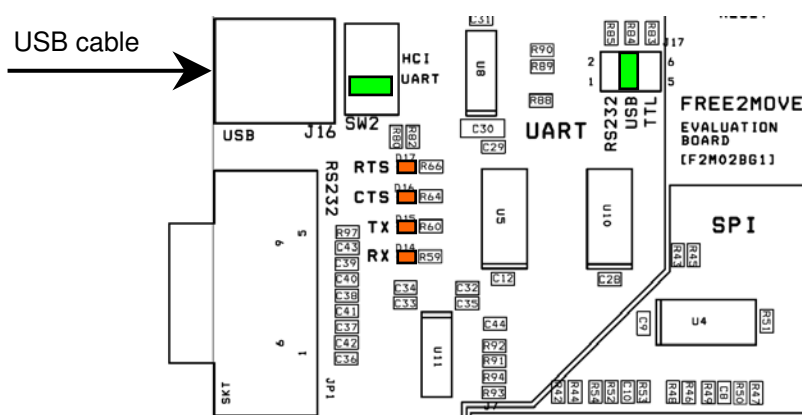

Image of the required settings for UART interface via USB

The first step is to install the Virtual Com Port (VCP) drivers supplied on the CD that comes with this kit. Installation documentation for the VCP is supplied on the CD.

When the driver is installed, you should be able to send and receive UART data from the module via the USB-interface. Note that it is also possible to power supply the evaluation board through the USB-connector. The different power supply possibilities are presented in section [3.4](#).

Four status leds are indicating the activity of the UART signals. All signals are seen from the connected device perspective, meaning that i.e. if the RX led is flashing, the Bluetooth module transmits data and the connected device is *receiving data* (RX).

Status leds

Signal	LED on	LED off
RTS	The connected device is ready to receive data	The connected device is not ready to receive data
CTS	The Bluetooth module is ready to receive data	The Bluetooth module is not ready to receive data
TX	The connected device is Transmitting data	IDLE
RX	The connected device is Receiving data	IDLE

The USB-connector is also used to communicate with the module via HCI (Host Controlled Interface) and this is made by setting SW2 in the HCI position. Please look at section [3.7](#) for more information about HCI.



Evaluation kit for General purpose Bluetooth™ Modules Datasheet

3.2.2 RS232

Moving the jumper on connector J17 to the RS232-position enables the RS232 interface.

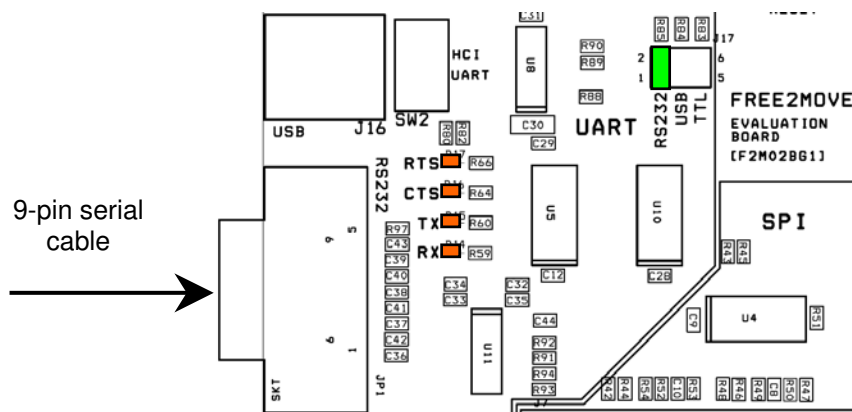

The RS232 interface can be used with a computer or other peripheral device that have a com-port. It is possible to connect the board to a computer (DTE-device) with a straight cable provided with the kit. The evaluation board acts as a DCE-device with the following pinout (seen from the D-sub):

9-pin D-SUB RS232 (JP1)

Pin	Description	Direction
1	DCD	OUT
2	TX	OUT
3	RX	IN
4	DTR	IN
5	GND	GND
6	DSR	OUT
7	RTS	IN
8	CTS	OUT
9	RI	OUT

The four status leds have the same function as described in the USB section.

3.2.3 CMOS

The third option to communicate with the Bluetooth device over the UART is via CMOS-levels (0-3v3). This is most likely when you want to communicate with a microcontroller or other device without using any level converters such as the USB or RS232-interface. The signals are available on connector J10 and are enabled by moving the jumper on connector J17 to the TTL (CMOS) position. The four status leds have the same function as described in the USB section.



Evaluation kit for General purpose Bluetooth™ Modules Datasheet

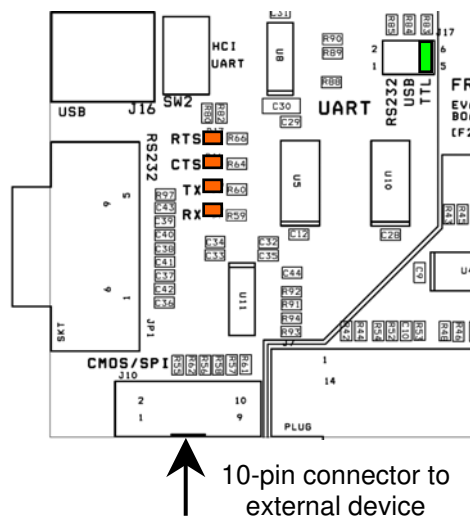

The pinout of the connector is presented in the table below (The SPI-signals should not be connected).

Pinout of connector J10 (CMOS/SPI)

Pin	Description	Direction
1	SPI_CS	I/O
2	SPI_MISO	I/O
3	SPI_MOSI	I/O
4	SPI_CLK	OUT
5	+3v3	OUT
6	GND	GND
7	TX	OUT
8	CTS	IN
9	RTS	OUT
10	RX	IN

3.3 SPI

Free2move offers the possibility to upgrade the firmware on the module via the SPI-interface. You will be able to access the module with Free2move's Flash utility provided on the CD. The program is made to easy configure and upgrade the firmware on the module. The evaluation board can only be connected to a computer via the parallel port but it will hopefully be possible connect the board via USB in the future (at connector J6) but this will involve an external SPI-to-USB converted, which is not ready yet.

It is also possible to use the evaluation board to upgrade modules on a customer PCB by routing out the SPI-signals on the PCB and connect it to connector J10. Be sure to detach any Bluetooth module from the OEM-board connector (J18) before you connect an external module.

Note: It is highly recommended to route out the SPI-signals from the Bluetooth module on your custom made PCB to be able to upgrade the firmware in the future!

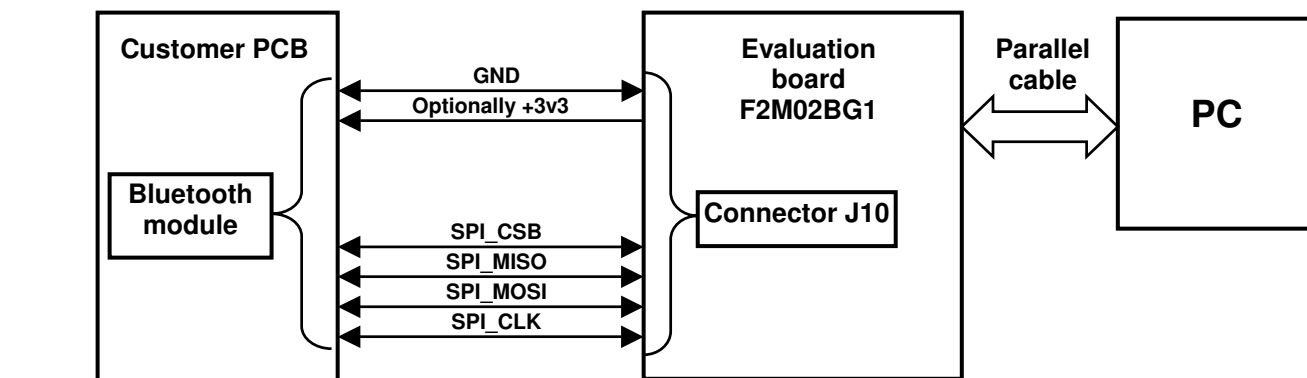



Evaluation kit for General purpose Bluetooth™ Modules Datasheet

Pin	Description	Direction
1	SPI_CSB	I/O
2	SPI_MISO	I/O
3	SPI_MOSI	I/O
4	SPI_CLK	I/O
5	+3v3	OUT
6	GND	GND
7	TX	OUT
8	CTS	IN
9	RTS	OUT
10	RX	IN

3.4 Power supply

The evaluation board has three separate power supplies for all functionality on the board. The board can be powered in three different ways, either through the USB-interface (default), the DC-jack or via the terminal block (EXT). The different options is presented in the figure below:

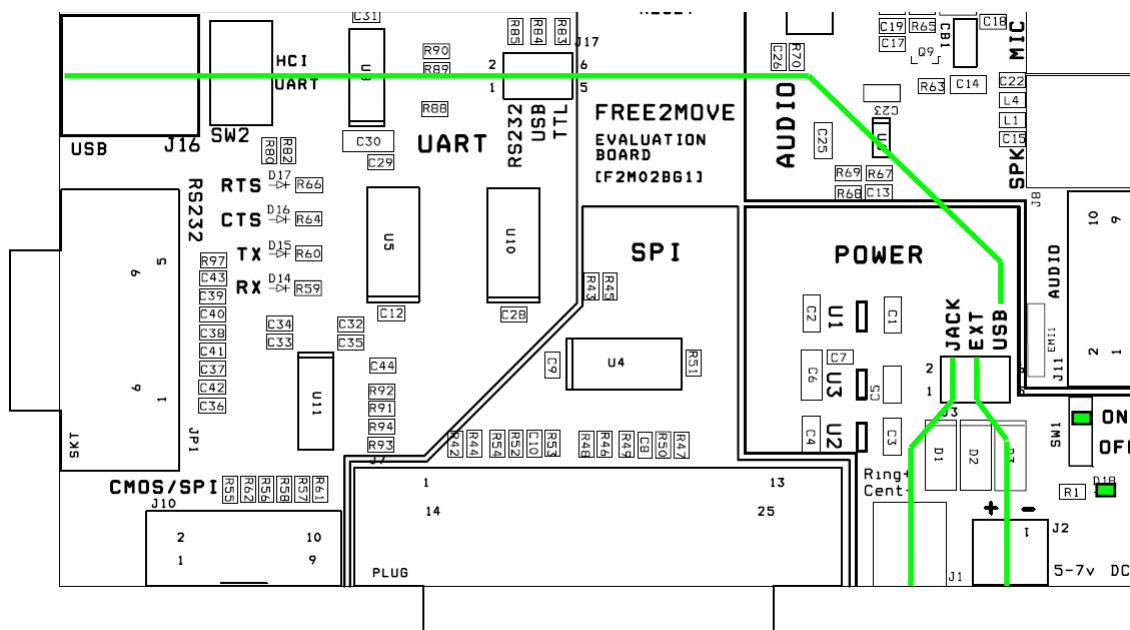

The preferred power source is selected by moving the jumper on connector J3 and the power is applied when moving switch SW1 to the ON position. A green led beneath the switch is indicating when the power is on. The Supplied voltage must be: 5-7v DC, minimum 400mA.

Note:

- Be sure to check the polarity before connecting the power to the board!
- The connected USB-device might not deliver the required current and will then not power up the entire board (The green power led will still shine but you will not be able to communicate with the module). Please use an external power source if this is the case!
- It is not possible to power the board over the USB-interface if you are using the HCI-firmware (Switch SW2 is in the "HCI" position)

3.5 Audio

The evaluation board has an onboard codec and a mono audio amplifier for direct drive of a microphone and speaker. The codec is enabled if all jumpers on pin-header J13 (PCM-EXT) are applied. You can



Evaluation kit for General purpose Bluetooth™ Modules Datasheet

connect a standard mono (or stereo) headset to the board using standard 3.5mm phono plugs where the microphone is connected to connector J9 (MIC) and the speaker is connected to J8 (SPK).

The board can drive a dielectric microphone if the jumpers are placed on pin-header CB1 and CB2.

It is also possible to use the microphone input as a single ended line input if you remove the jumper from CB1 (or differential line input if both CB1 and CB2 are removed). The audio signals are available on connector J11 for other external audio connections. The PCM signals from the Bluetooth module are also present on connector J14 and can be used if all jumpers are removed from pin-header J13.

J11 (Audio)

Pin	Description	Direction
1	+3v3 Analog	OUT
2	GND	GND
3	VO+	OUT
4	GND	GND
5	VO-	OUT
6	GND	GND
7	MIC+	IN
8	GND	GND
9	MIC-	IN
10	GND	GND

J14 (PCM)

Pin	Description	Direction
1	GND	GND
2	PCM_IN	IN
3	GND	GND
4	PCM_OUT	OUT
5	GND	GND
6	PCM_CLK	I/O
7	GND	GND
8	PCM_SYNC	I/O
9	GND	GND
10	GND	GND

J8 (SPK) / J9 (MIC)

Pin	Desc.	Dir.
SPK		
1	VO-	OUT
2	VO+	OUT
3	NC	-
4	VO+	OUT
MIC		
1	MIC-	IN
2	MIC+	IN
3	NC	-
4	MIC+	IN

J13 (PCM-EXT) / CB1 / CB2

Signal	Jumper on	Jumper off
SYNC	SYNC signal routed to codec	SYNC signal disconnected from codec
CLK	CLK signal routed to codec	CLK signal disconnected from codec
DIN	Data IN signal routed to codec	Data IN signal disconnected from codec
DOUT	Data OUT signal routed to codec	Data OUT signal disconnected from codec
CB1	Bias voltage to the microphone applied	No bias voltage to the microphone
CB2	Negative differential input tied to GND, used for single ended line input	Negative differential input not grounded, used for differential input

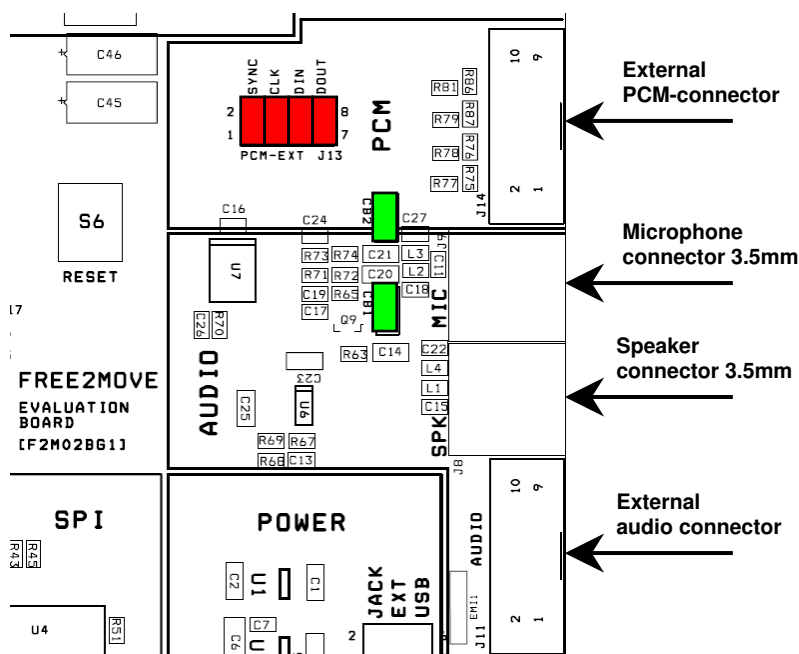
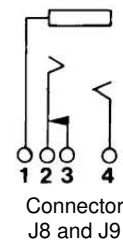



Evaluation kit for General purpose Bluetooth™ Modules Datasheet

3.6 Bluetooth module connector

Connector J18 is used to attach a Free2move Bluetooth OEM-board. The OEM-board should be placed so the drill hole (4mm in diameter) on both the Evaluation-kit and the OEM-board is matching each other. The antenna (or connector) on the OEM-board should point away from the evaluation board, shown in the image below. The pinout of connector is presented in table below.

Connector J18 (Bluetooth module)

Pin nr	Description	Direction
1	+VCC_BT	Power
2	GND	GND
3	+VCC_PA	Power
4	SPI_CLK	I/O
5	/RESET	IN
6	SPI_MISO	I/O
7	GND	GND
8	SPI_MOSI	I/O
9	TX	OUT
10	SPI_CS	I/O
11	RX	IN
12	GND	GND
13	CTS	OUT
14	PCM_CLK	I/O
15	RTS	IN
16	PCM_OUT	OUT
17	USB-	I/O
18	PCM_SYNC	I/O
19	USB+	I/O
20	PCM_IN	IN

Pin nr	Description	Direction
21	GND	GND
22	GND	GND
23	PIO[5]	GPIO
24	PIO[6]	GPIO
25	PIO[4]	GPIO
26	PIO[7]	GPIO
27	PIO[3]	GPIO
28	PIO[8]	GPIO
29	PIO[2]	GPIO
30	PIO[9]	GPIO
31	PIO[1]	GPIO
32	PIO[10]	GPIO
33	PIO[0]	GPIO
34	PIO[11]	GPIO
35	GND	GND
36	GND	GND
37	AIO[0]	GPIO
38	AIO[3]	GPIO
39	AIO[1]	GPIO
40	AIO[2]	GPIO

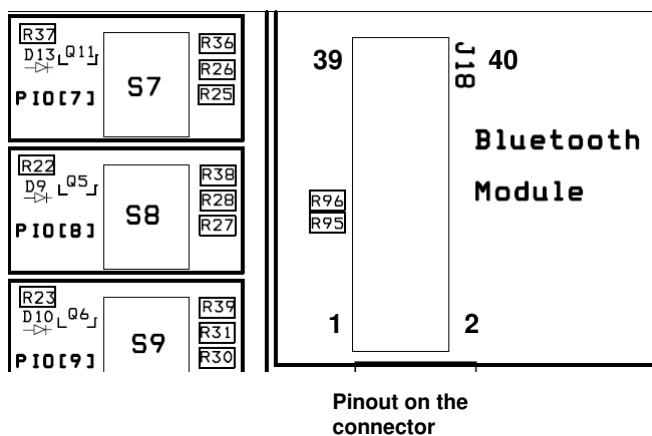
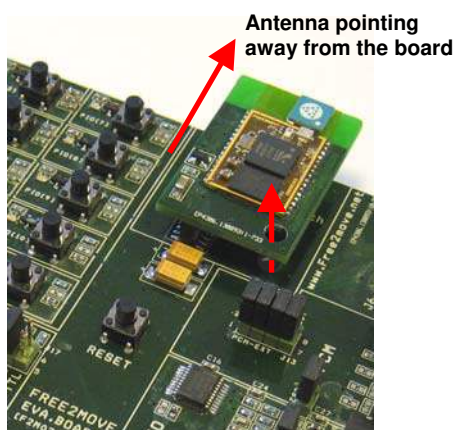



Evaluation kit for General purpose Bluetooth™ Modules Datasheet

3.7 Host Controlled Interface (HCI)

The module can be controlled by an external host processor via the Host Controlled Interface. The host processor is then running the Bluetooth stack and is communication over the USB interface. You will have to change the firmware on the module to a “HCI firmware” to be able to use an external host processor. Setting switch SW2 in the HCI-position described in the image below enables the HCI interface. Please look at the specific datasheet for the module for more information about the HCI firmware.

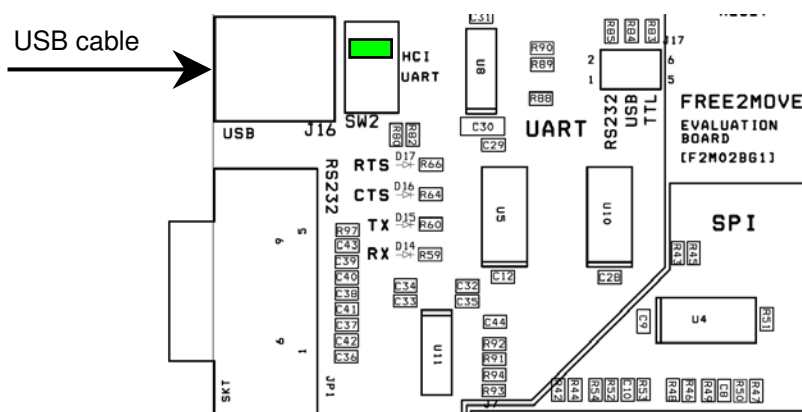

Important note: The evaluation board has a hardware error making it impossible to power the module when switch SW2 is in the “HCI” position. The error occurs because the USB-to-UART transceiver will put the voltage regulators powering the modules to an “idle”-state. The only simple solution to this is to cut the stripe line going from resistor R90 to pin 12 on the IC U8 (FTDI). Please look at the image below for information on which stripe line to cut. The evaluation board will have exactly the same behavior without the stripe line and can be used with all other firmware versions.

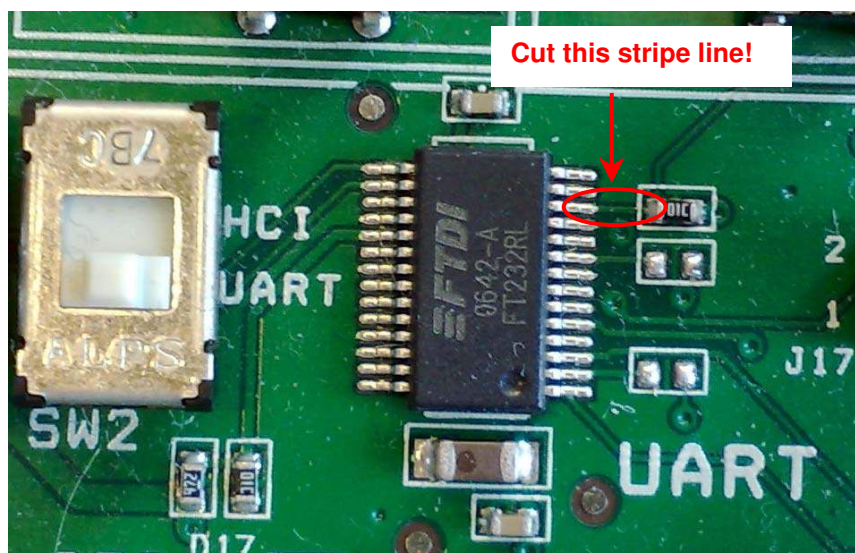

Note: The Host Bluetooth Stack is not provided from Free2move.



Evaluation kit for General purpose Bluetooth™ Modules

Datasheet

4 Layout

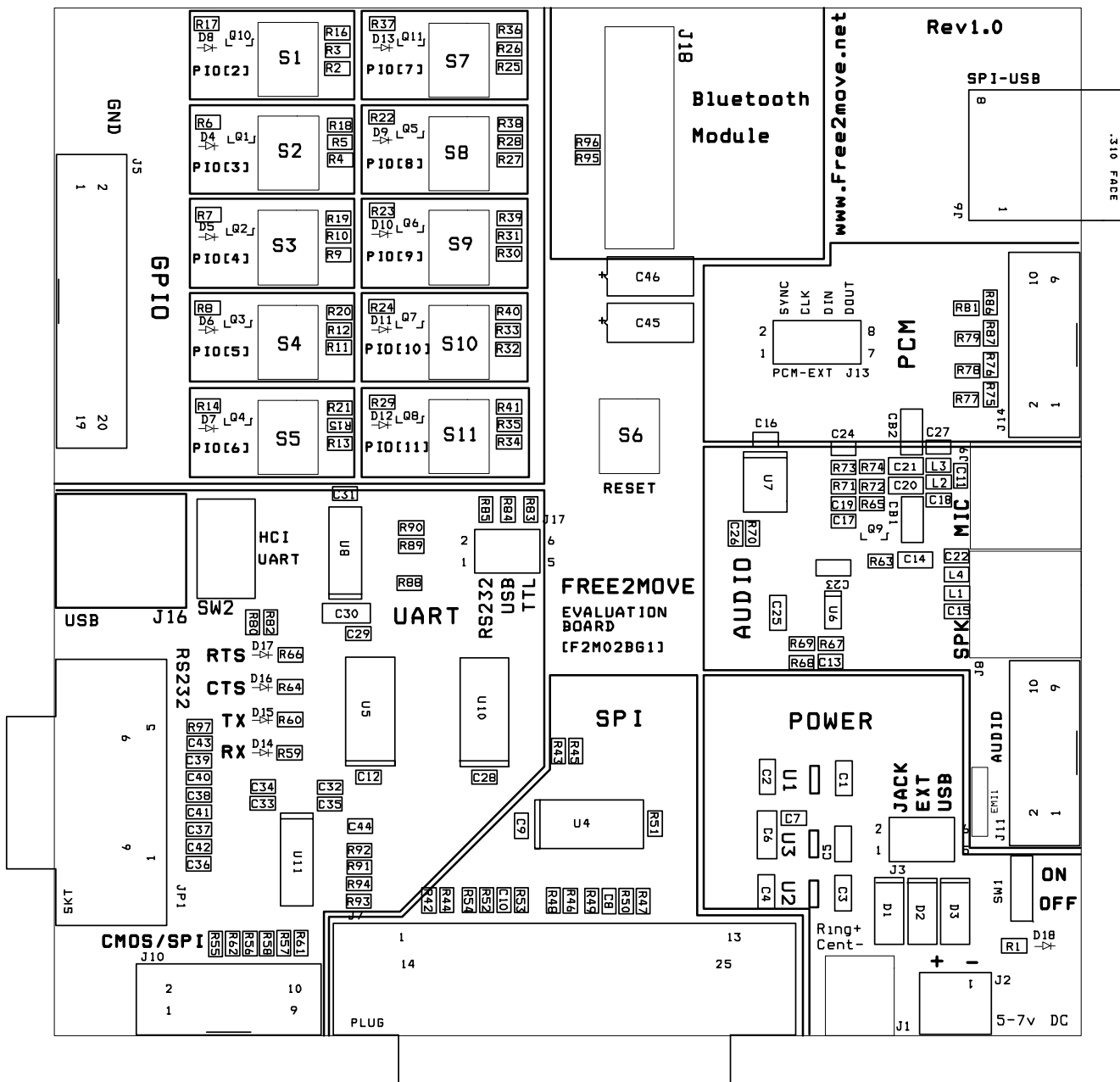



Evaluation kit for General purpose Bluetooth™ Modules Datasheet

5 Schematics

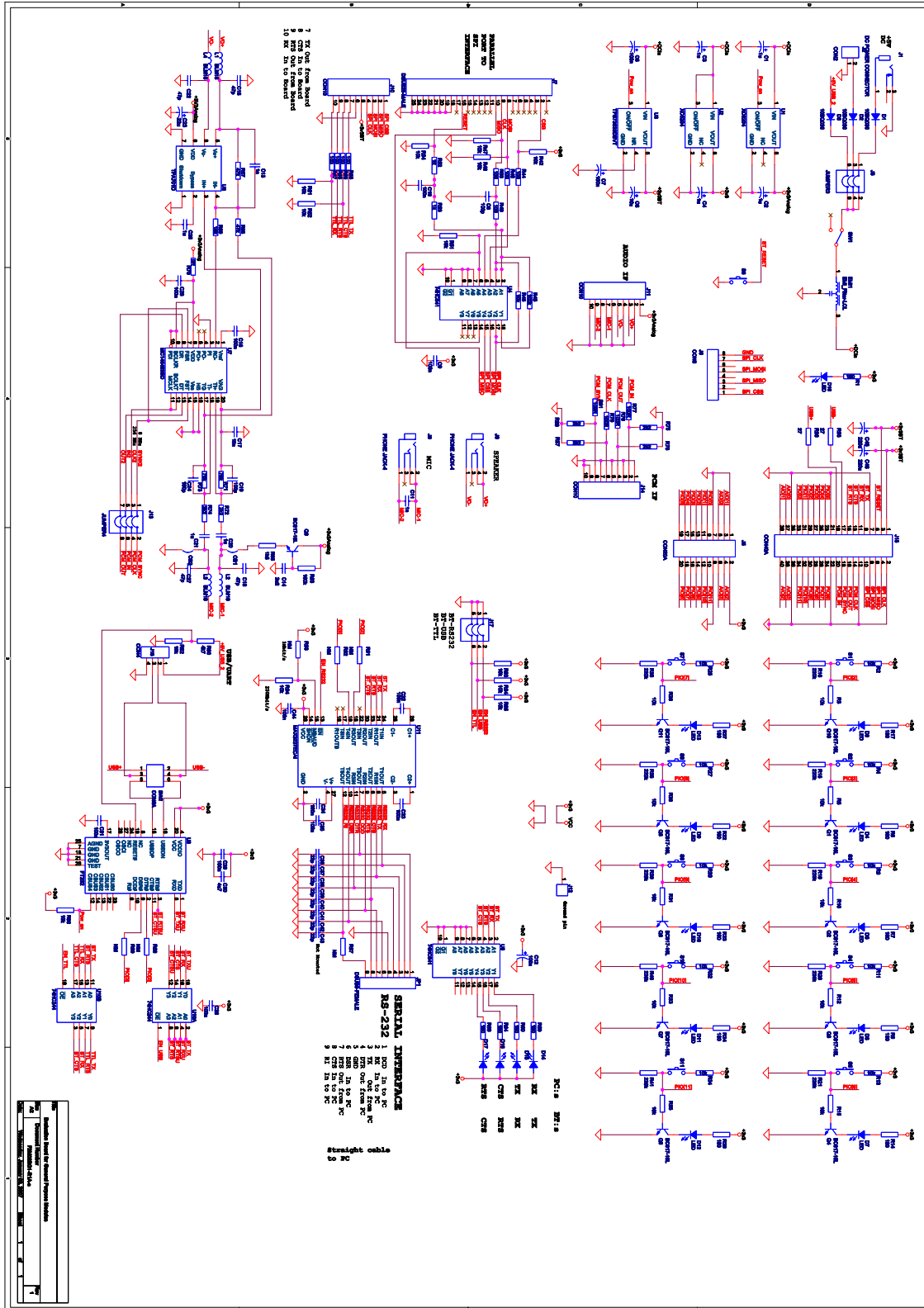



Evaluation kit for General purpose Bluetooth™ Modules Datasheet

6 Bill of materials

Quantity	Circuit Reference	Description	Value	Tolerance	Voltage	Package	Manuf.	Manuf. Nr.
14	D4,5,6,7,8,9,10,11,12,13, 14,15,16,17	Yellow led				0603	Everlight	EL19-21UYC
1	D18	Green led				0603	Everlight	EL19-21SYGC
2	CB1,2	Circuit breaker 1x2				2,54mm	AMP	0-0826629-2
9	C1,2,3,4,5,14,20,21,25	Ceramic capacitor	1u	Y5V	16V	0805		
13	C7,9,10,12,16,28,29,31,3 2,33,34,35,44	Ceramic capacitor	100n	X7R	16V	0603		
1	C6	Ceramic capacitor	10u	Y5V	10V	1206		
3	C8,19,24	Ceramic capacitor	100p	COG	16V	0603		
2	C11,13	Ceramic capacitor	1n	X7R	16V	0603		
4	C15,18,22,27	Ceramic capacitor	47p	COG	16V	0603		
1	C17	Ceramic capacitor	10n	X7R	16V	0603		
1	C23	Ceramic capacitor	22u	Y5V	10V	1206		
1	C30	Ceramic capacitor	4u7	Y5V	10V	1206		
NM	C36,37,38,39,40,41,42, 43	Ceramic capacitor	22p	COG	16V	0603		
2	C45,46	Tantalum capacitor	220u		4V	7343		
NM	R88,89,91,92,93	Thick film resistor				0603		
3	D1,2,3	Diod						10BQ030
1	EMI1	EMI filter					Murata	NFM61R30T472
1	JP1	DSUB-9 Female						
1	J1	Power connector					KYCON	KLDX-SMT-0201L-B
1	J2	Terminal block					Phoenix	MKDS 1/2-3,81
2	J3,17	Pin terminal 2x3				2,54mm	AMP	0-0826632-3
1	J18	Socket con. 2x20				1,27mm	GradConn	BB02-CR402-K05-000000
1	J5	Connector 2x10				2,54mm		
NM	J6	RJ45-connector					AMP	555153-1
1	J7	DSUB-25 Male						
2	J8,9	Phone jack				3,5mm		
3	J10,11,14	Connector 2x5				2,54mm		
1	J12	Pin terminal				1 pole		
1	J13	Pin terminal 2x4				2,54mm	AMP	0-0826632-4
1	J16	USB-B port					AMP	787780-1
4	L1,2,3,4	Ferrite				0603	Murata	BLM18GG471SN1
11	Q1,2,3,4,5,6,7,8,9,10,11	Transistor				SOT23		BC817-16
15	R1,6,7,8,14,17,22,23,24, 29,37,59,60,64,66	Thick film resistor	180			0603		
32	R2,3,4,5,9,10,11,12,13, 15,25,26,27,28,30,31,32, 33,34,35,42,45,47,48,51, 54,82,83,84,85,90,94	Thick film resistor	10k			0603		
12	R44,46,49,50,55,56,57, 58,77,78,79,81	Thick film resistor	100			0603		
2	R43,63	Thick film resistor	100k			0603		
2	R52,53	Thick film resistor	1k			0603		
1	R70	Thick film resistor	0R			0603		
10	R16,18,19,20,21,36,38, 39,40,41	Thick film resistor	220k			0603		
2	R95,96	Thick film resistor	27			0603		
1	R65	Thick film resistor	1k5			0603		
1	R67	Thick film resistor	47k			0603		
1	R69	Thick film resistor	15k			0603		



Evaluation kit for General purpose Bluetooth™ Modules Datasheet

2	R71,73	Thick film resistor	75k	0603		
6	R72,74,75,76,86,87	Thick film resistor	2k2	0603		
1	R80	Thick film resistor	4k7	0603		
1	SW1	Power Switch			EAO	09.03290.01
1	SW2	Switch			ALPS	SSSS922000
11	S1,2,3,4,5,6,7,8,9,10,11	Button			ALPS	SKHHBV
2	U1,2	Voltage regulator		SOT23-5	Torex	XC6209B332MR
1	U3	Voltage regulator		SOT23-5	Texas	TPS73633DBVT
2	U4,5	buffer/line driver		SO20		74HC541
1	U6	Amplifier		SOIC8	Texas	TPA701D
1	U7	Codec		SSOP20	Winbond	W681360RG
1	U8	USB-rs232tran.		SSOP28	FTDI	FT232RL
1	U10	buffer/line driver		S020		74HC244
1	U11	rs232-transceiver		SSOP28	Maxim	MAX3237CAI/EAI



Evaluation kit for General purpose Bluetooth™ Modules Datasheet

7 Ordering information

Evaluation kit (without OEM-board!)

Part nr:	Description
F2M03G-KIT-1	Single Evaluation kit for General purpose Bluetooth modules

OEM-boards

Part nr:	Description
F2M02GLA-S01	OEM-board with a F2M03GLA Bluetooth module and the Wireless UART v4 firmware
F2M02GX-S01	OEM-board with a F2M03GX Bluetooth module and the Wireless UART v4 firmware
F2M02GXA-S01	OEM-board with a F2M03GXA Bluetooth module and the Wireless UART v4 firmware

OEM-boards with additional pin sockets

Part nr:	Description
F2M02GLA-S01-K	OEM-board with a F2M03GLA, Wireless UART v4 and 40pin socket
F2M02GX-S01-K	OEM-board with a F2M03GX, Wireless UART v4, 40pin socket and antenna
F2M02GXA-S01-K	OEM-board with a F2M03GXA, Wireless UART v4 and 40pin socket

Please visit our website: www.free2move.net for more information about local distributors and dealers.



Evaluation kit for General purpose Bluetooth™ Modules Datasheet

8 Document history

Date	Revision	Reason for Change
MAY 2008	e	Added information about hardware problem when using modules with HCI-firmware
DEC 2007	d	Minor changes, Pin 7 and 9 was swapped on connector J11 (MIC+ and MIC-)
OCT 2007	c	Minor changes
APRIL 2007	b	Minor changes in the document, the double kit is removed from order information
APRIL 2007	a	Original Publication of this document.

F2M03G-KIT Datasheet

Datasheet_F2M03G-KIT_rev_e.pdf

Last revision change
May 2008



Evaluation kit for General purpose Bluetooth™ Modules Datasheet

Acronyms and definitions

Term:	Definition:
Bluetooth	A set of technologies providing audio and data transfer over short-range radio
ACL	Asynchronous Connection-Less. A Bluetooth data packet.
AC	Alternating Current
A-law	Audio encoding standard
API	Application Programming Interface
BCSP	BlueCore™ Serial Protocol
BER	Bit Error Rate. Used to measure the quality of a link
C/I	Carrier Over Interferer
CMOS	Complementary Metal Oxide Semiconductor
CODEC	Coder Decoder
CPU	Central Processing Unit
CQDDR	Channel Quality Driven Data Rate
CTS	Clear to Send
CVSD	Continuous Variable Slope Delta Modulation
DAC	Digital to Analogue Converter
dBm	Decibels relative to 1mW
DC	Direct Current
DFU	Device Firmware Upgrade
GCI	General Circuit Interface. Standard synchronous 2B+D ISDN timing interface
HCI	Host Controller Interface
Host	Application's microcontroller
Host Controller	Bluetooth integrated chip
HV	Header Value
ISDN	Integrated Services Digital Network
ISM	Industrial, Scientific and Medical
ksamples/s	kilosamples per second
L2CAP	Logical Link Control and Adaptation Protocol (protocol layer)
LC	Link Controller
LSB	Least-Significant Bit
p-law	Encoding standard
MISO	Master In Serial Out
OHCI	Open Host Controller Interface
PA	Power Amplifier
PCB	Printed Circuit Board
PCM	Pulse Code Modulation. Refers to digital voice data
PIO	Parallel Input Output
RAM	Random Access Memory
RF	Radio Frequency
RFCOMM	Protocol layer providing serial port emulation over L2CAP
RISC	Reduced Instruction Set Computer
RSSI	Receive Signal Strength Indication
RTS	Ready To Send
RX	Receive or Receiver
SCO	Synchronous Connection-Oriented. Voice oriented Bluetooth packet
SDP	Service Discovery Protocol
SIG	Special Interest Group
SPI	Serial Peripheral Interface
SPP	Serial Port Profile
TBD	To Be Defined
TX	Transmit or Transmitter
UART	Universal Asynchronous Receiver Transmitter
USB	Universal Serial Bus or Upper Side Band (depending on context)
VM	Virtual Machine
www	world wide web



Evaluation kit for General purpose Bluetooth™ Modules Datasheet

Contact information

For support questions please contact your local dealer

For other purposes use: info@free2move.net

Website: www.free2move.net

Local dealer/distributor

A large rectangular area enclosed by a dashed line, intended for the user to provide the name and contact information of their local dealer or distributor.

The information given herein includes text, drawings, illustrations and schematics that are believed to be reliable. However, Free2move makes no warranties as to its accuracy or completeness and disclaims any liability in connection with its use. Free2move will in no case be liable for any incidental, indirect or consequential damages arising out of sale, resale, use or misuse of the product. Users of Free2move products should make their own evaluation to determine the suitability of each such product for the specific application.