

96 press-in contacts

☒ = position with contact

☐ = position without contact

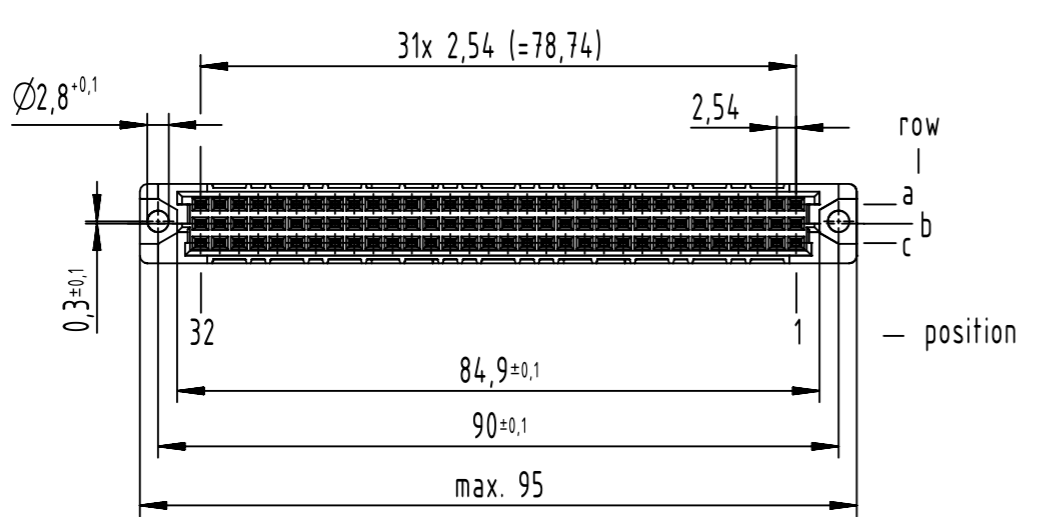
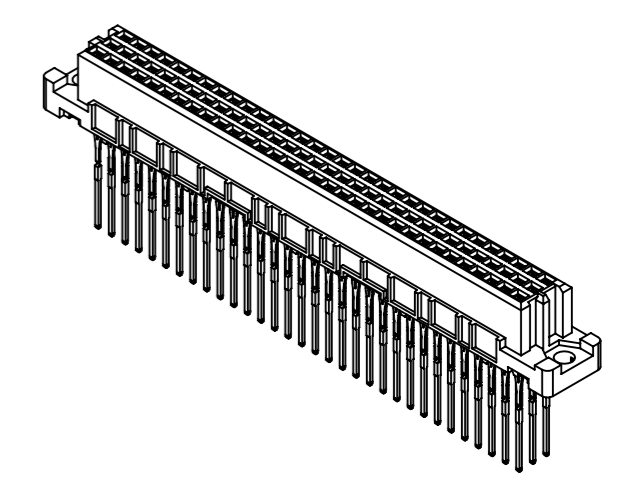
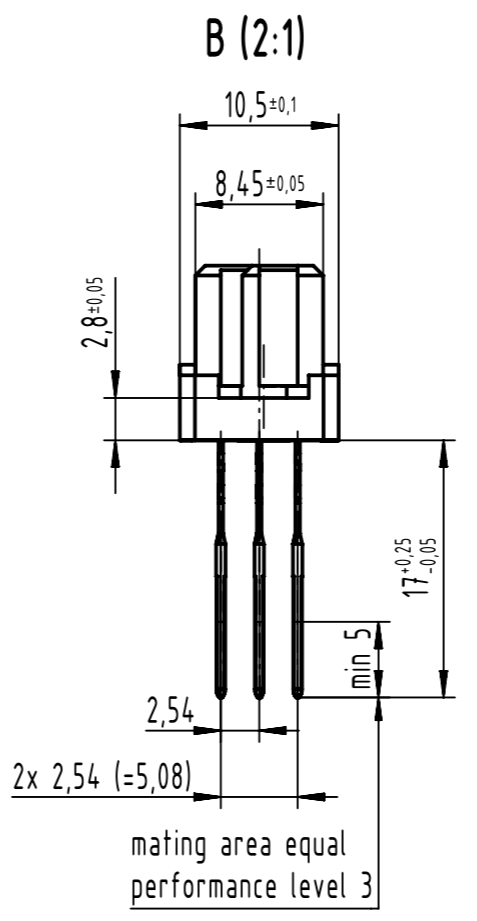
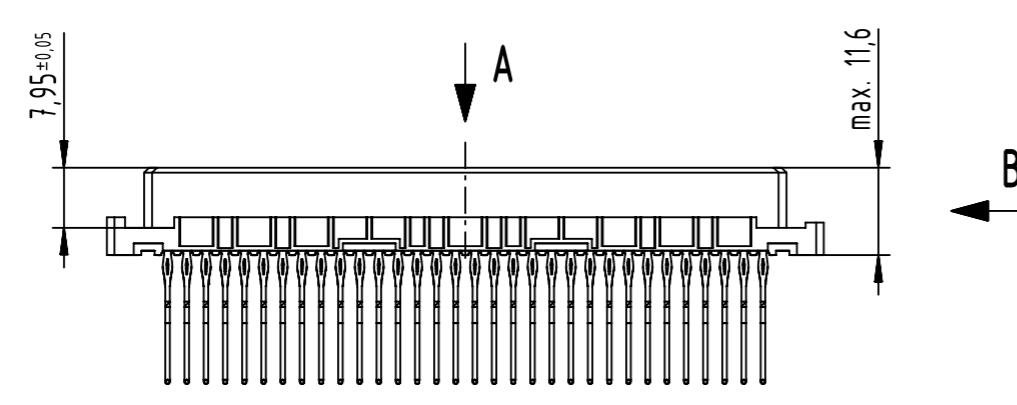

1 recommended configuration of plated through holes and further information see product data sheet

09 03 296 6862	2
part no.	performance level

	All rights reserved	Created by STORCK	Inspected by LEHNERT	Standardisation 302077	Date 2021-02-16	State Final Release
	Department EL PD	Title DIN Signal type C female press-in 17.0 96-pole			Doc-Key / ECM-Nr. 100173852/UGD/240/G 500000189290	
HARTING D-32339 Espelkamp	Type TB	Number 0903296X862		Rev. G	Page 1/1	