

# PM-24 SERIES

**Related Information**

- General terms and conditions ..... F-13
- Sensor selection guide..... P.427~
- Glossary of terms / General precautions.....P.1455~ / P.1458~
- Korea's S-mark..... P.1506

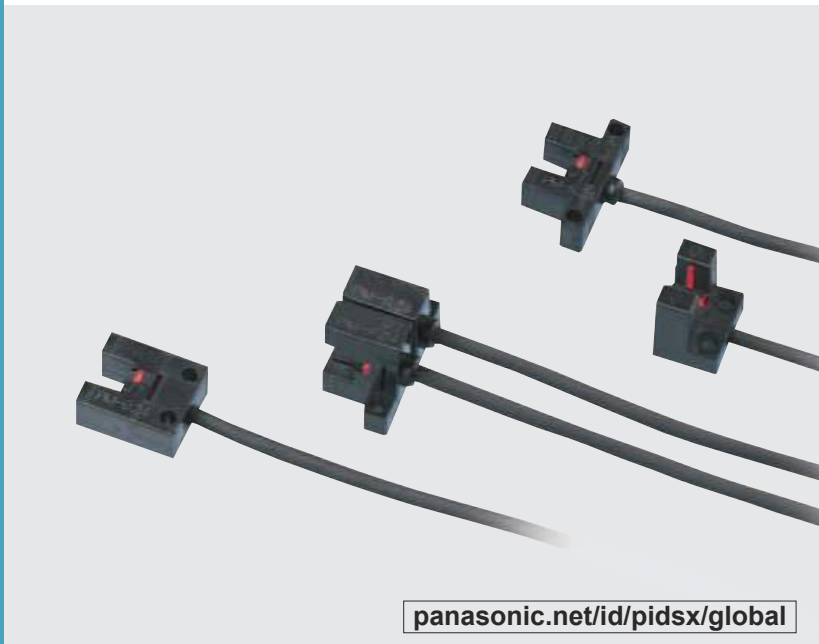

[panasonic.net/id/pidsx/global](http://panasonic.net/id/pidsx/global)



## Extremely small size enables space saving!!

### Extremely small size and space saving

PM-24 series contributes to the miniaturization or space saving of your equipment.

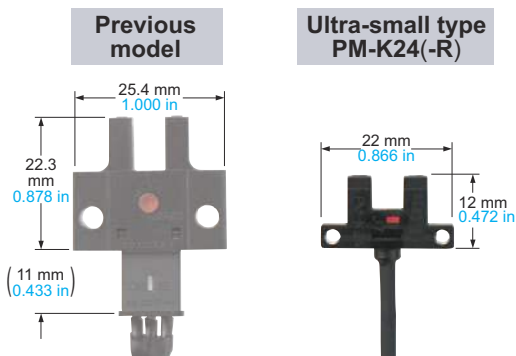

### Equipped with two independent outputs

All models are equipped with two independent outputs—Light-ON and Dark-ON. Hence, one model suffices even if the output is to be used differently, depending upon the location of use. Also, since two independent outputs have been provided, cumbersome handling of the output conversion control input, or fear of logic inversion due to a cable break, is eliminated. The sensor can be connected to the existing wiring as it is.

#### Example of connection with a commercial intermediate connector

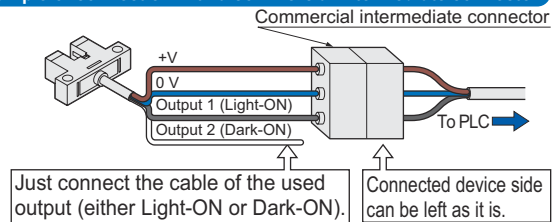

Note: Ensure to insulate the unused output wire.

### Wide model variety

A wide variety of 5 shapes and 15 models is available. You may select from this wide range to suit the mounting conditions.

### Meets global requirements

Conforms to Europe's EMC Directive and obtains UL Recognition. Both, NPN and PNP output models are available. The **PM-□24** has also obtained Korea's S-mark certification.

- FIBER SENSORS
- LASER SENSORS
- PHOTOELECTRIC SENSORS
- MICRO PHOTOELECTRIC SENSORS
- AREA SENSORS
- LIGHT CURTAINS / SAFETY COMPONENTS
- PRESSURE / FLOW SENSORS
- INDUCTIVE PROXIMITY SENSORS
- PARTICULAR USE SENSORS
- SENSOR OPTIONS
- SIMPLE WIRE-SAVING UNITS
- WIRE-SAVING SYSTEMS
- MEASUREMENT SENSORS
- STATIC ELECTRICITY PREVENTION DEVICES
- LASER MARKERS
- PLC
- HUMAN MACHINE INTERFACES
- ENERGY CONSUMPTION VISUALIZATION COMPONENTS
- FA COMPONENTS
- MACHINE VISION SYSTEMS
- UV CURING SYSTEMS
- Selection Guide
- U-shaped
- Convergent Reflective
- PM-64
- PM-24
- PM-44/PM-54

## APPLICATIONS

### Sensing the starting point on a rotating body

The starting point can be sensed by making a slit in the rotating body.

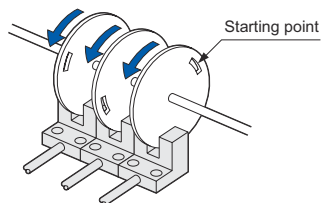

## ORDER GUIDE

Type	Appearance (mm in)	Sensing range	Model No. (Note)	Output	Output operation
Ultra-small			<b>PM-K24</b>	NPN open-collector transistor	Incorporated with 2 outputs: Light-ON / Dark-ON
			<b>PM-K24P</b>	PNP open-collector transistor	
			<b>PM-K24-R</b>	NPN open-collector transistor	
			<b>PM-L24</b>	NPN open-collector transistor	
			<b>PM-L24P</b>	PNP open-collector transistor	
			<b>PM-L24-R</b>	NPN open-collector transistor	
			<b>PM-F24</b>	NPN open-collector transistor	
			<b>PM-F24P</b>	PNP open-collector transistor	
			<b>PM-F24-R</b>	NPN open-collector transistor	
			<b>PM-R24</b>	NPN open-collector transistor	
			<b>PM-R24P</b>	PNP open-collector transistor	
			<b>PM-R24-R</b>	NPN open-collector transistor	
			<b>PM-U24</b>	NPN open-collector transistor	
			<b>PM-U24P</b>	PNP open-collector transistor	
			<b>PM-U24-R</b>	NPN open-collector transistor	

Note: The suffix “-R” indicates a flexible cable type.

### 3 m 9.843 ft cable length type

3 m 9.843 ft cable length type (standard: 1 m 3.281 ft) is also available. (excluding flexible cable type and PNP output type)

When ordering this type, suffix “-C3” to the model No.

(e.g.) 3m 9.843 ft cable length type of **PM-K24** is “**PM-K24-C3**”.

## OPTIONS

Designation	Model No.	Description
Mounting screw	<b>MS-M2</b>	Mounting screw with washers for the ultra-small type sensor (50 pcs. lot). It can mount securely as it is spring washer attached.

### Mounting screw

• MS-M2

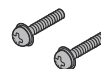

FIBER SENSORS

LASER SENSORS

PHOTO-ELECTRIC SENSORS

MICRO PHOTO-ELECTRIC SENSORS

AREA SENSORS

LIGHT CURTAINS / SAFETY COMPONENTS

PRESSURE / FLOW SENSORS

INDUCTIVE PROXIMITY SENSORS

PARTICULAR USE SENSORS

SENSOR OPTIONS

SIMPLE WIRE-SAVING UNITS

WIRE-SAVING SYSTEMS

MEASUREMENT SENSORS

STATIC ELECTRICITY PREVENTION DEVICES

LASER MARKERS

PLC

HUMAN MACHINE INTERFACES

ENERGY CONSUMPTION VISUALIZATION COMPONENTS

FA COMPONENTS

MACHINE VISION SYSTEMS

UV CURING SYSTEMS

Selection Guide

U-shaped

Convergent Reflective

PM-64

PM-24

PM-44/  
PM-54

## SPECIFICATIONS

Item	Model No.	Type	Ultra-small	
				With flexible cable
		NPN output	<b>PM-□24</b>	<b>PM-□24-R</b>
		PNP output	<b>PM-□24P</b>	—
Sensing range			5 mm <b>0.197 in</b> (fixed)	
Minimum sensing object			0.8 × 1.8 mm <b>0.031 × 0.071 in</b> opaque object	
Hysteresis			0.05 mm <b>0.002 in</b> or less	
Repeatability			0.03 mm <b>0.001 in</b> or less	
Supply voltage			5 to 24 V DC ±10 % Ripple P-P 10 % or less	
Current consumption			15 mA or less	
Output			<NPN output type> NPN open-collector transistor <ul style="list-style-type: none"> <li>• Maximum sink current: 50 mA</li> <li>• Applied voltage: 30 V DC or less (between output and 0 V)</li> <li>• Residual voltage: 0.7 V or less (at 50 mA sink current) 0.4 V or less (at 16 mA sink current)</li> </ul>	<PNP output type> PNP open-collector transistor <ul style="list-style-type: none"> <li>• Maximum source current: 50 mA</li> <li>• Applied voltage: 30 V DC or less (between output and + V)</li> <li>• Residual voltage: 0.7 V or less (at 50 mA source current) 0.4 V or less (at 16 mA source current)</li> </ul>
Utilization category			DC-12 or DC-13	
Output operation			Incorporated with 2 outputs: Light-ON / Dark-ON	
Response time			Under light received condition: 20 μs or less Under light interrupted condition: 100 μs or less (Response frequency: 1 kHz or more) (Note 2)	
Operation indicator			Vermilion LED (lights up under light received condition)	
Pollution degree			3 (Industrial environment)	
Ambient temperature (Note 3, 4)			-25 to +55 °C <b>-13 to +131 °F</b> (No dew condensation or icing allowed), Storage: -30 to +80 °C <b>-22 to +176 °F</b>	
Ambient humidity			35 to 85 % RH, Storage: 35 to 85 % RH	
Ambient illuminance			Fluorescent light: 1,000 lx at the light-receiving face	
EMC			EN 60947-5-2	
Voltage withstandability			1,000 V AC for one min. between all supply terminals connected together and enclosure	
Insulation resistance			50 MΩ, or more, with 250 V DC megger between all supply terminals connected together and enclosure	
Vibration resistance			10 to 2,000 Hz frequency, 1.5 mm <b>0.059 in</b> amplitude in X, Y and Z directions for two hours each	
Shock resistance			15,000 m/s <sup>2</sup> acceleration (1,500 G approx.) in X, Y and Z directions for three times each	
Emitting element			Infrared LED (Peak emission wavelength: 940 nm <b>0.037 mil</b> , non-modulated)	
Material			Enclosure: PBT, Slit cover: Polycarbonate	
Cable			0.09 mm <sup>2</sup> 4-core cabtyre cable [ <b>PM-□24-R</b> : 0.1 mm <sup>2</sup> flexible, oil and heat resistant cabtyre cable (Note 5)], 1 m <b>3.281 ft</b> long	
Cable extension			Extension up to total 100 m <b>328.084 ft</b> is possible with 0.3 mm <sup>2</sup> , or more, cable.	
Weight			Net weight: 10 g approx.	

Notes: 1) Where measurement conditions have not been specified precisely, the conditions used were an ambient temperature of +23 °C **+73.4 °F**.

2) The response frequency is the value when the disc, given in the figure below, is rotated.

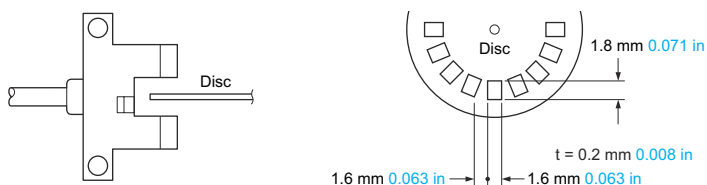

3) In case the **PM-24** series is used at an ambient temperature of +50 °C **+122 °F**, or more, make sure to mount it on a metal body.

4) Take care that the flexibility of the **PM-□24-R** cable is lost if the ambient temperature is -10 °C **+14 °F** or less.

5) The cable of **PM-□24-R** is a flexible cable usable on a moving base. When the sensor is mounted on a moving base, fix the sensor cable joint so that stress is not applied to it. (Models other than the **PM-□24-R** cannot be used on a moving base.)

## I/O CIRCUIT AND WIRING DIAGRAMS

### PM-□24 PM-□24-R

NPN output type

#### I/O circuit diagram

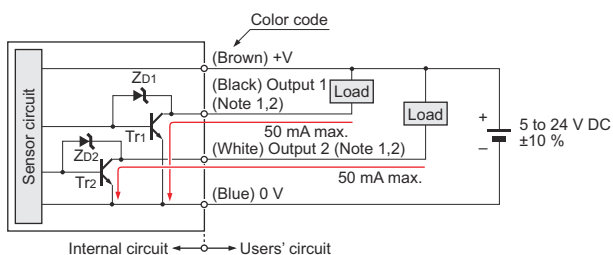

Notes: 1) Make sure to connect terminals correctly as the sensor does not incorporate a reverse polarity protection circuit. Further, the output is not incorporated with a short-circuit protection circuit. Do not connect it directly to a power supply or a capacitive load. Faulty wiring may result in damage.  
2) Ensure to insulate the unused output wire.

Symbols ... ZD1, ZD2: Surge absorption zener diode  
Tr1, Tr2 : NPN output transistor

#### Wiring diagram

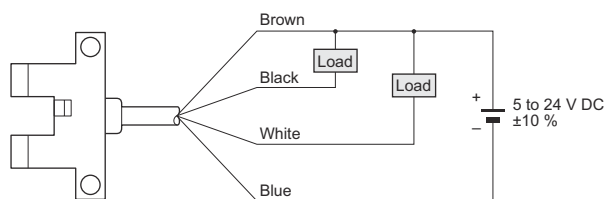

#### Output operation

	Color code	Output operation
Output 1	Black	Light-ON
Output 2	White	Dark-ON

### PM-□24P

PNP output type

#### I/O circuit diagram

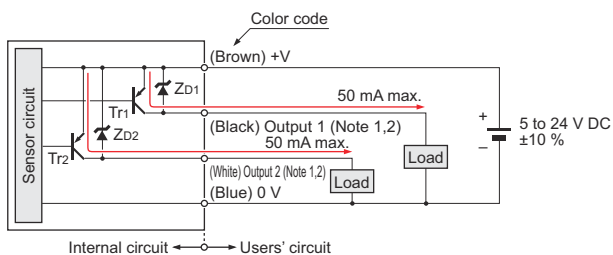

Notes: 1) Make sure to connect terminals correctly as the sensor does not incorporate a reverse polarity protection circuit. Further, the output is not incorporated with a short-circuit protection circuit. Do not connect it directly to a power supply or a capacitive load. Faulty wiring may result in damage.  
2) Ensure to insulate the unused output wire.

Symbols ... ZD1, ZD2 : Surge absorption zener diode  
Tr1, Tr2 : PNP output transistor

#### Wiring diagram

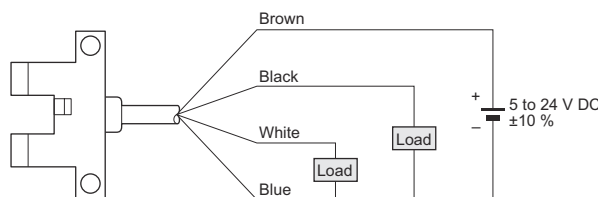

#### Output operation

	Color code	Output operation
Output 1	Black	Light-ON
Output 2	White	Dark-ON

## SENSING CHARACTERISTICS (TYPICAL)

#### Sensing position

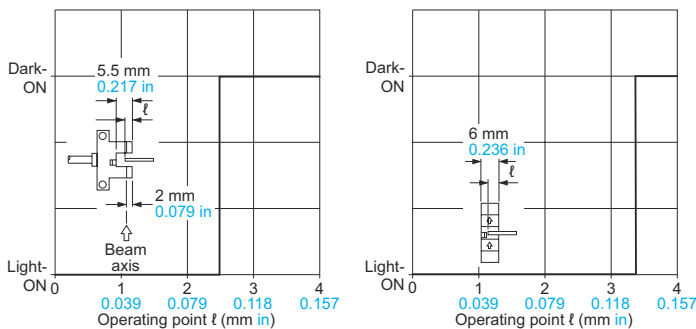

FIBER SENSORS

LASER SENSORS

PHOTO-ELECTRIC SENSORS

MICRO PHOTO-ELECTRIC SENSORS

AREA SENSORS

LIGHT CURTAINS / SAFETY COMPONENTS

PRESSURE / FLOW SENSORS

INDUCTIVE PROXIMITY SENSORS

PARTICULAR USE SENSORS

SENSOR OPTIONS

SIMPLE WIRE-SAVING UNITS

WIRE-SAVING SYSTEMS

MEASUREMENT SENSORS

STATIC ELECTRICITY PREVENTION DEVICES

LASER MARKERS

PLC

HUMAN MACHINE INTERFACES

ENERGY CONSUMPTION VISUALIZATION COMPONENTS

FA COMPONENTS

MACHINE VISION SYSTEMS

UV CURING SYSTEMS

Selection Guide

U-shaped

Convergent

Reflective

PM-64

PM-24

PM-44/  
PM-54

- FIBER SENSORS
- LASER SENSORS
- PHOTO-ELECTRIC SENSORS
- MICRO PHOTO-ELECTRIC SENSORS
- AREA SENSORS
- LIGHT CURTAINS/ SAFETY COMPONENTS
- PRESSURE / FLOW SENSORS
- INDUCTIVE PROXIMITY SENSORS
- PARTICULAR USE SENSORS
- SENSOR OPTIONS
- SIMPLE WIRE-SAVING UNITS
- WIRE-SAVING SYSTEMS
- MEASUREMENT SENSORS
- STATIC ELECTRICITY PREVENTION DEVICES
- LASER MARKERS
- PLC
- HUMAN MACHINE INTERFACES
- ENERGY CONSUMPTION VISUALIZATION COMPONENTS
- FA COMPONENTS
- MACHINE VISION SYSTEMS
- UV CURING SYSTEMS

## PRECAUTIONS FOR PROPER USE

Refer to p.1458~ for general precautions.



- Never use this product as a sensing device for personnel protection.
- In case of using sensing devices for personnel protection, use products which meet laws and standards, such as OSHA, ANSI or IEC etc., for personnel protection applicable in each region or country.



Make sure to connect terminals correctly as the sensor does not incorporate a reverse polarity protection circuit. Further, the output is not incorporated with a short-circuit protection circuit. Do not connect it directly to a power supply or a capacitive load. Faulty wiring may result in damage.

### Mounting

- When fixing the sensor with screws, use M2 screws and the tightening torque should be 0.15 N·m or less. Further, use small, round type plain washers. (ø4.3 mm ø0.169 in)
- When using the optional mounting screw set **MS-M2**, a spring washer is included.

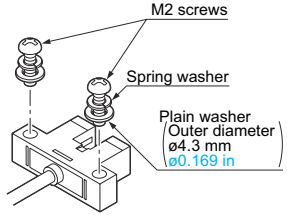

- In case the **PM-24** series is used at an ambient temperature of +50 °C +122 °F, or more, make sure to mount it on a metal body.

### Cable extension

- Cable extension is possible up to an overall length of 100 m 328.084 ft with a 0.3 mm<sup>2</sup>, or more, cable. However, since a voltage drop shall occur due to the cable extension, ensure that the power supply voltage at the end of the cable attached to the sensor is within the rating.

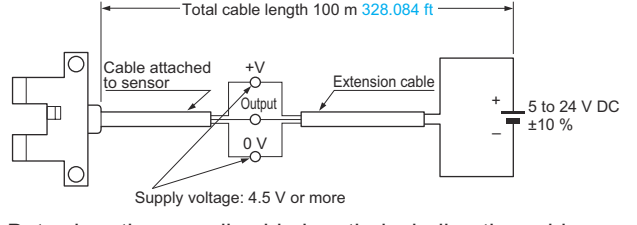

But, when the overall cable length, including the cable attached to the sensor, is as given below, there is no need to confirm the voltage.

Conductor cross-section area of extension cable	Total cable length
0.08 to 0.1 mm <sup>2</sup>	Up to 5 m 16.404 ft
0.2 mm <sup>2</sup>	Up to 10 m 32.808 ft
0.3 mm <sup>2</sup>	Up to 20 m 65.617 ft

### Others

- Since the sensor is intended for use inside machines, no special countermeasures have been taken against extraneous light. Take care that extraneous light is not directly incident on the beam receiving section.
- Do not use during the initial transient time (50 ms) after the power supply is switched on.
- The cable of **PM-□24-R** is a flexible cable usable on a moving base. When the sensor is mounted on a moving base, fix the sensor cable joint so that stress is not applied to it. (Models other than the **PM-□24-R** cannot be used on a moving base.)
- Take care that the flexibility of the **PM-□24-R** cable is lost if the ambient temperature is -10 °C +14 °F or less.

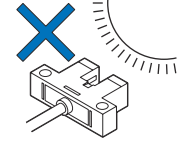

- Selection Guide
- U-shaped
- Convergent Reflective

- PM-64**
- PM-24**
- PM-44/ PM-54**

**DIMENSIONS (Unit: mm in)**

The CAD data in the dimensions can be downloaded from our website.

**PM-K24(P) PM-K24-R** Sensor

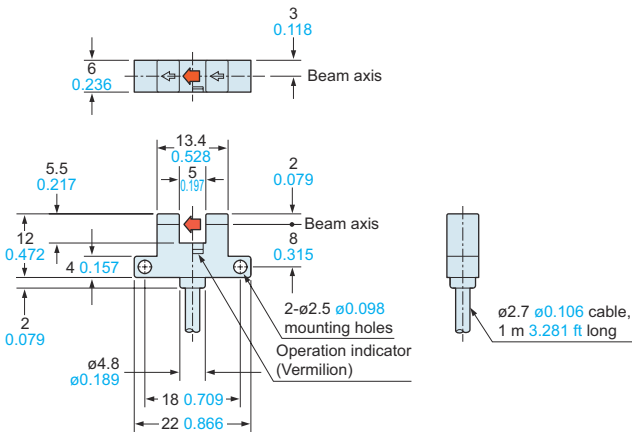

**PM-L24(P) PM-L24-R** Sensor

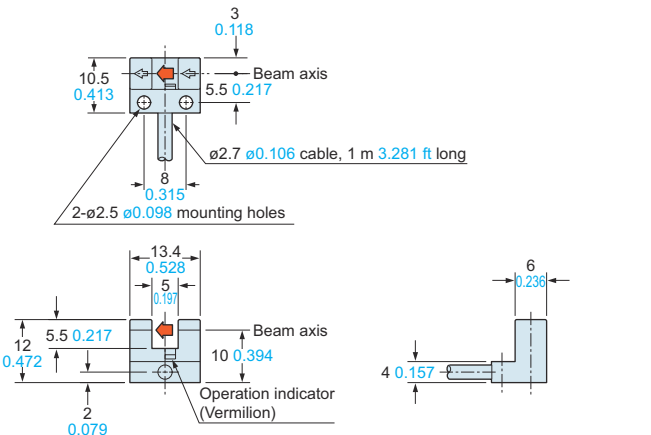

**PM-F24(P) PM-F24-R** Sensor

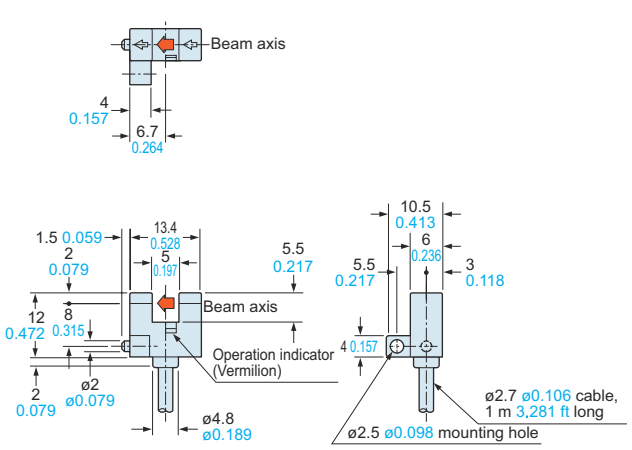

**PM-R24(P) PM-R24-R** Sensor

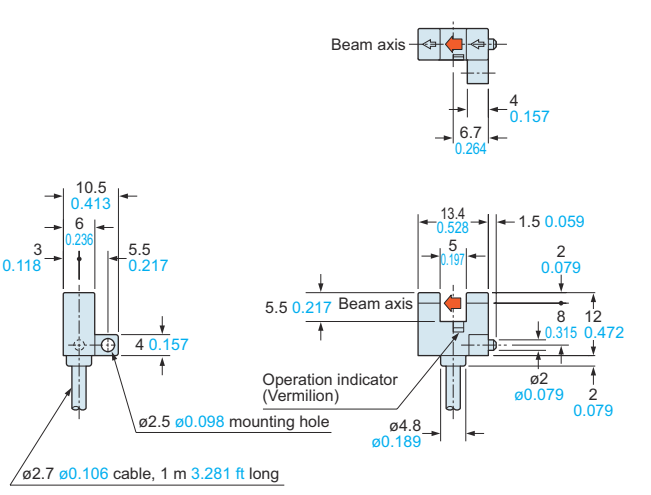

**PM-U24(P) PM-U24-R** Sensor

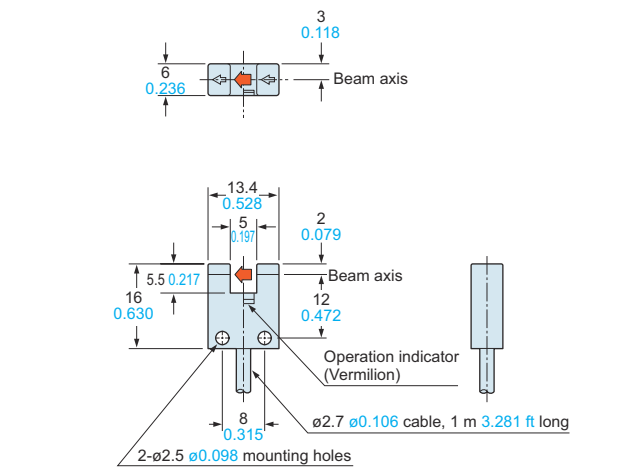

- FIBER SENSORS
- LASER SENSORS
- PHOTO-ELECTRIC SENSORS
- MICRO PHOTO-ELECTRIC SENSORS
- AREA SENSORS
- LIGHT CURTAINS / SAFETY COMPONENTS
- PRESSURE / FLOW SENSORS
- INDUCTIVE PROXIMITY SENSORS
- PARTICULAR USE SENSORS
- SENSOR OPTIONS
- SIMPLE WIRE-SAVING UNITS
- WIRE-SAVING SYSTEMS
- MEASUREMENT SENSORS
- STATIC ELECTRICITY PREVENTION DEVICES
- LASER MARKERS
- PLC
- HUMAN MACHINE INTERFACES
- ENERGY CONSUMPTION VISUALIZATION COMPONENTS
- FA COMPONENTS
- MACHINE VISION SYSTEMS
- UV CURING SYSTEMS

- Selection Guide
- U-shaped
- Convergent
- Reflective

- PM-64
- PM-24
- PM-44/PM-54