

PAGE 1/2	ISSUE 17-08-18B	SERIES ATTENUATOR	PART NUMBER R417206110
----------	-----------------	-----------------------------	-------------------------------

SCALE 1 : 2

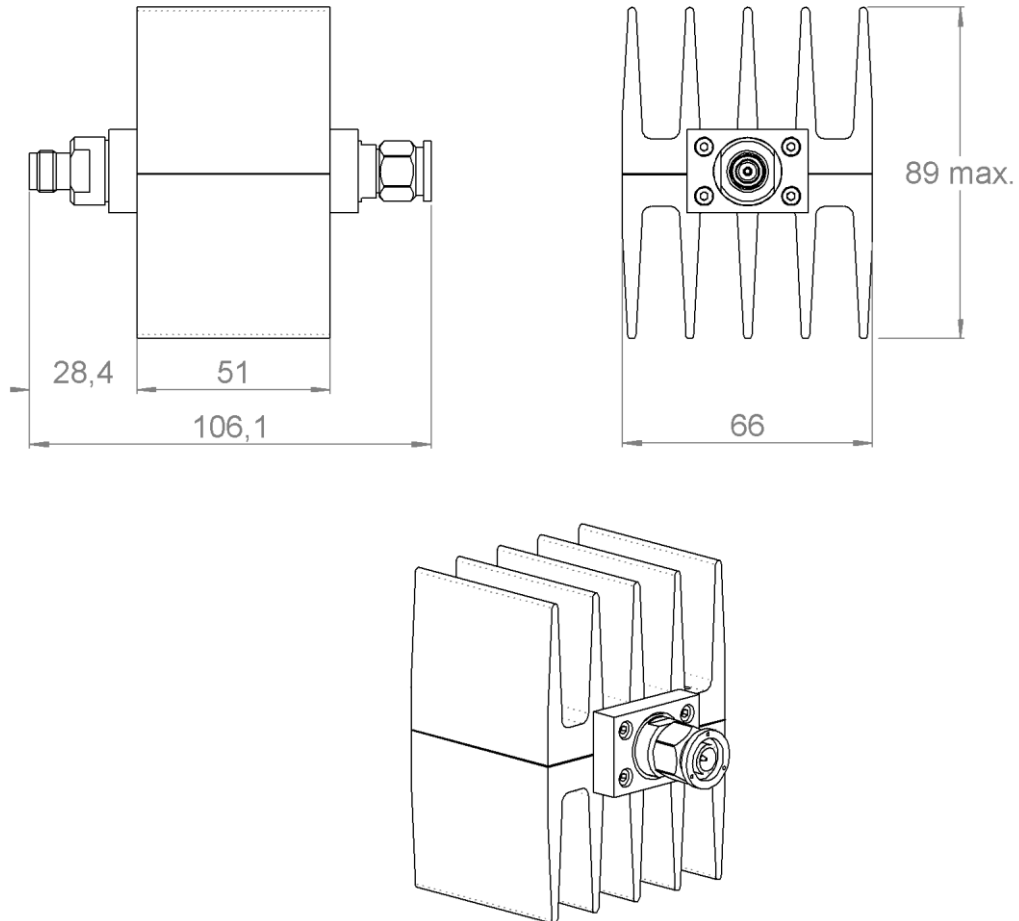

All dimensions are in mm. Tolerances according ISO 2768 m-H



COMPONENTS	MATERIALS	PLATING (µm)
Body	STAINLESS STEEL	PASSIVATED
Male center contact	BERYLLIUM COPPER	GOLD 0.5 OVER NICKEL PHOSPHORUS 2
Female center contact	BERYLLIUM COPPER	GOLD 0.5 OVER NICKEL PHOSPHORUS 2
Outer contact		
Insulator	PTFE	
Gasket	SILICONE RUBBER	
Substrate	ALUMINA	
Resistor	THICK FILM	
Others parts	ALUMINIUM	BLACK PAINTING

PAGE 2/2	ISSUE 17-08-18B	SERIES ATTENUATOR	PART NUMBER R417206110
----------	-----------------	-----------------------------	-------------------------------

ELECTRICAL CHARACTERISTICS

Frequency (GHz)	DC - 1	1 - 2	2 - 3
V.S.W.R (≤)	1.10	1.25	1.35
Deviation(±dB)	0.7	0.7	0.7

Operating Frequency Range	DC - 3	GHz
Impedance	50	Ω
Nominal Attenuation	6	dB
Peak power at 25°C (1μs, 1%)	5000	W
Average power at 25°C	50	W (Free Air Cooled)
		W (Conduction Cooled)

MECHANICAL CHARACTERISTICS

Connectors	TNC	Male Female	MIL-C 39012
Weight	417,5000 g		

ENVIRONMENTAL CHARACTERISTICS

Operating temperature range	-55 /+125 °C
Storage temperature range	-55 /+125 °C

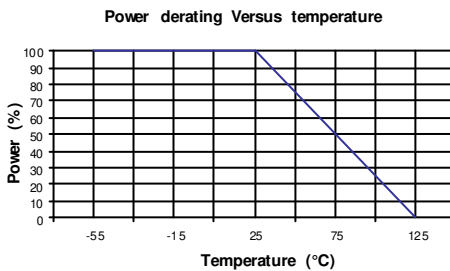

SPECIFICATION

OTHER CHARACTERISTICS