

## Consistent Microsecond Throughput: Models with Direct Conversion Join the Lineup

- Analog Input Units for converting analog input signals into binary data
- Analog Output Units for converting binary data into analog output signals



CJ1W-AD042



CJ1W-DA042V

## Features

### Analog Input Units

- Input up to eight analog signals with one Unit.
- Functions include line disconnection detection, averaging, peak value holding, offset/gain adjustment, and scaling. (Offset/gain adjustment is not supported by the CJ1W-AD042. Scaling is supported only by the CJ1W-AD042.)
- High-speed A/D conversion in 20  $\mu$ s/point with direct conversion function \* (CJ1W-AD042 only).

### Analog Output Units

- Output up to eight analog signals with one Unit.
- Functions include output holding, offset/gain adjustment, and scaling. (Offset/gain adjustment is not supported by the CJ1W-DA042V. Scaling is supported only by the CJ1W-DA08V/DA08C/DA042V.)
- High-speed D/A conversion in 20  $\mu$ s/point with direct conversion function \* (CJ1W-DA042V only).

### Analog I/O Units

- Input up to four analog signals and output up to two analog signals with one Unit.
- Functions include line disconnection detection, input averaging, scaling, input peak value holding, output holding, ratio conversion, and offset/gain adjustment.

\* Direct Conversion Instructions for High-speed type can be used to create a consistent response time from input through data processing and output. With the Machine Automation Controller NJ-series, the direct conversion function cannot be used. This function is supported only by the CJ-series CPU Unit.

## System Configuration

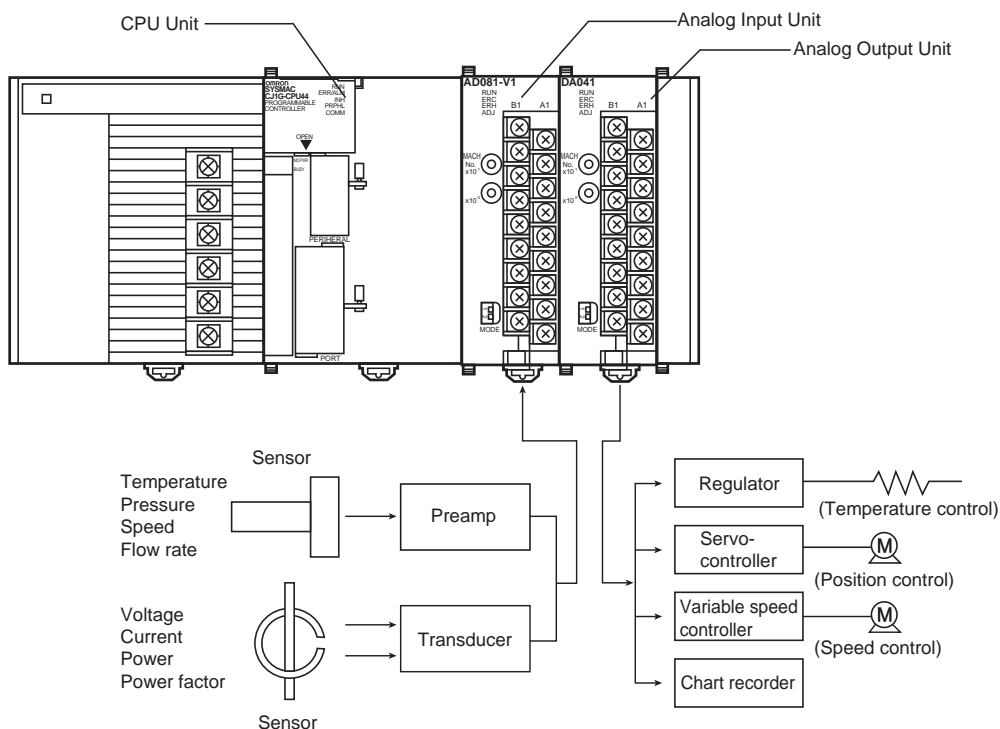



**Note:** The above diagram is an installation example for the CJ1W-AD081-V1 Analog Input Units and CJ1W-DA041 Analog Output Units.

## Ordering Information

### International Standards

- The standards are abbreviated as follows: U: UL, U1: UL (Class I Division 2 Products for Hazardous Locations), C: CSA, UC: cULus, UC1: cULus (Class I Division 2 Products for Hazardous Locations), CU: cUL, N: NK, L: Lloyd, and CE: EC Directives.
- Contact your OMRON representative for further details and applicable conditions for these standards.

### Analog Input Units



Unit type	Product name	I/O points	Signal range selection	Signal range	Resolution	Conversion period	Accuracy at ambient temperature of 25°C	External connection	No. of unit numbers allocated	Current consumption (A)		Model	Standards
										5 V	24 V		
CJ1 Special I/O Units	Analog Input Unit <i>High-speed type</i> 	4 inputs	Set separately for each input	1 to 5 V (1/10,000), 0 to 10 V (1/20,000), -5 to 5 V (1/20,000), -10 to 10 V (1/40,000), and 4 to 20 mA (1/10,000)		20 μs/1 point, 25 μs/2 points, 30 μs/3 points, 35 μs/4 points The Direct conversion is provided. *1	Voltage: ±0.2% of F.S. Current: ±0.4% of F.S.	Removable terminal block	1	0.52	---	CJ1W-AD042	UC1, CE
	Analog Input Units 	8 inputs								1 to 5 V, 0 to 5 V, 0 to 10 V, -10 to 10 V, 4 to 20 mA	1/4,000 (Settable to 1/8,000) *2	1 ms/point (250 μs/point can also be set.) *2	Voltage: ±0.2% of F.S. Current: ±0.4% of F.S. *3
		4 inputs		CJ1W-AD041-V1									

\*1 With the Machine Automation Controller NJ-series, the direct conversion function using the AIDC instruction cannot be used.

\*2 The resolution and conversion speed cannot be set independently. If the resolution is set to 1/4,000, then the conversion speed will be 1 ms/point.

\*3 At 23 ±2°C

### Analog Output Units

Unit type	Product name	I/O points	Signal range selection	Signal range	Resolution	Conversion period	Accuracy at ambient temperature of 25°C	External connection	External power supply	No. of unit numbers allocated	Current consumption (A)		Model	Standards
											5 V	24 V		
CJ1 Special I/O Units	Analog Output Unit <i>High-speed type</i> 	4 outputs	Set separately for each output	1 to 5 V (1/10,000), 0 to 10 V (1/20,000), and -10 to 10 V (1/40,000)		20 μs/ 1 point, 25 μs/ 2 points, 30 μs/ 3 points, 35 μs/ 4 points The Direct conversion is provided. *1	±0.3% of F.S.	Removable terminal block	---	1	0.40	---	CJ1W-DA042V	UC1, CE
	Analog Output Units 	8 outputs									1 to 5 V, 0 to 5 V, 0 to 10 V, -10 to 10 V	1/4,000 (Settable to 1/8,000) *2	1 ms/point (Settable to 250 μs/point) *2	±0.3% of F.S.
		8 outputs		4 to 20 mA	24 VDC +10% -15% , 170 mA max.	0.17 *3	CJ1W-DA08C	UC1, N, CE						
				4 outputs	1 to 5 V, 0 to 5 V, 0 to 10 V, -10 to 10 V, 4 to 20 mA	1/4,000	1 ms/point	Voltage: ±0.3% of F.S. Current: ±0.5% of F.S.	24 VDC +10% -15% , 200 mA max.	0.2 *3	CJ1W-DA041	UC1, N, L, CE		
				2 outputs							24 VDC +10% -15% , 140 mA max.		0.14 *3	CJ1W-DA021

\*1 With the Machine Automation Controller NJ-series, the direct conversion function using the AIDC instruction cannot be used.

\*2 The resolution and conversion speed cannot be set independently. If the resolution is set to 1/4,000, the conversion speed will be 1 ms/point.

\*3 This is for an external power supply, and not for internal current consumption.

### Analog I/O Units

Unit type	Product name	I/O points	Signal range selection	Signal range	Resolution	Conversion period	Accuracy at ambient temperature of 25°C	External connection	No. of unit numbers allocated	Current consumption (A)		Model	Standards
										5 V	24 V		
CJ1 Special I/O Units		4 inputs	Set separately for each input and output	1 to 5 V, 0 to 5 V, 0 to 10 V, -10 to 10 V, 4 to 20 mA	1/4,000 (Settable to 1/8,000)	1 ms/point (Settable to 500 μs/point)	Voltage: ±0.2% of F.S. Current: ±0.2% of F.S.	Removable terminal block	1	0.58	-	CJ1W-MAD42	UC1, N, L, CE
		2 outputs											

**Note:** The resolution and conversion speed cannot be set independently. If the resolution is set to 1/4,000, then the conversion speed will be 1 ms/point.

### Accessories

Model	Accessories
CJ1W-AD081-V1/AD041-V1 CJ1W-DA08V/DA08C/DA041/DA021 CJ1W-DA042V CJ1W-MAD42	None.
CJ1W-AD042	Four jumpers (For a current input, a jumper is used to connect the current input positive terminal and the voltage input positive terminal.)

### Mountable Racks

Model	NJ system		CJ system (CJ1, CJ2)		CP1H system	NSJ system *1			
	CPU Rack	Expansion Rack	CPU Rack	Expansion Backplane	CP1H PLC	NSJ Controller	Expansion Backplane		
CJ1W-AD042	7 Units *5	10 Units *6 (per Expansion Rack)	8 Units *2	9 Units *3 (per Expansion Backplane)	2 Units *4	Not supported	9 Units *3 (per Expansion Backplane)		
CJ1W-AD081-V1	9 Units *5	10 Units *6 (per Expansion Rack)	10 Units *2	10 Units *3 (per Expansion Backplane)			10 Units *3 (per Expansion Backplane)		
CJ1W-AD041-V1									
CJ1W-DA042V	10 Units *5	10 Units *6 (per Expansion Rack)						8 Units *3 (per Expansion Backplane)	8 Units *3 (per Expansion Backplane)
CJ1W-DA08V									
CJ1W-DA08C									
CJ1W-DA041									
CJ1W-DA021									
CJ1W-MAD42	7 Units *5	10 Units *6 (per Expansion Rack)			7 Units *2	8 Units *3 (per Expansion Backplane)		8 Units *3 (per Expansion Backplane)	

**Note:** It may not be possible to mount this many Units to a Rack depending on the current consumption of the other Units.

\*1 Product no longer available to order.

\*2 This is the number of Units for a CJ2H-CPU6 CJ2H CPU Unit (without EtherNet/IP) and a CJ1W-PA205 or CJ1W-PD025 Power Supply Unit.

\*3 This is the number of Units for a CJ1W-PA205 or CJ1W-PD025 Power Supply Unit.

\*4 A CP1W-EXT01 CJ Unit Adaptor is required.

\*5 This is the number of Units for a NJ501 CPU Unit, and a NJ-PA3001 or NJ-PD3001 Power Supply Unit.

\*6 This is the number of Units for a NJ-PA3001 or NJ-PD3001 Power Supply Unit.

## Individual Specifications

### Analog Input Units CJ1W-AD041-V1/AD081-V1/AD042

#### Specifications

Item		CJ1W-AD041-V1	CJ1W-AD081-V1	CJ1W-AD042	
Unit type		CJ-series Special I/O Unit			
Isolation *1		Between I/O and Controller signals: Photocoupler (No isolation between I/O signals.)		Between I/O and Controller signals: Digital isolator (No isolation between I/O signals.)	
External terminals		18-point detachable terminal block (M3 screws)			
Power consumption		420 mA max. at 5 VDC		520 mA max. at 5 VDC	
Dimensions (mm)		31 × 90 × 65 mm (W × H × D)			
Weight		140 g max.		150 g max.	
General specifications		Conforms to general specifications for CJ Series.			
Input specifications	Number of analog inputs	4	8	4	
	Input signal range *2	1 to 5 V 0 to 5 V 0 to 10 V -10 to 10 V 4 to 20 mA *3		1 to 5 V 0 to 10 V -5 to 5 V -10 to 10 V 4 to 20 mA *4	
	Maximum rated input (for 1 point) *5	Voltage Input: ±15 V Current Input: ±30 mA			
	Input impedance	Voltage Input: 1 MΩ min. Current Input: 250 Ω (rated value)			
	Resolution	4,000/8,000 *6		1 to 5 V	10,000
				0 to 10 V	20,000
				-5 to 5 V	20,000
				-10 to 10 V	40,000
				4 to 20 mA	10,000
Converted output data	16-bit binary data				
Accuracy *7	25°C *8	Voltage Input: ±0.2% of F.S. Current Input: ±0.4% of F.S.			
	0°C to 55°C	Voltage Input: ±0.4% of F.S. Current Input: ±0.6% of F.S.			
A/D conversion period *9	1 ms/250 μs per point *6		20 μs/1 point, 25 μs/2 points, 30 μs/3 points, 35 μs/4 points		
Mean value processing	Stores the last "n" data conversions in the buffer, and stores the mean value of the conversion values. Buffer number: n = 2, 4, 8, 16, 32, 64		Stores the last "n" data conversions in the buffer, and stores the mean value of the conversion values. Buffer number: n = 2, 4, 8, 16, 32, 64, 128, 256, 512		
Peak value holding	Stores the maximum conversion value while the Peak Value Hold Bit is ON.				
Scaling	---		Setting values in any specified unit within a range of ±32,000 as the upper and lower limits allows A/D conversion to be executed and analog signals to be output with these values as full scale.		
Input disconnection detection	Detects the disconnection and turns ON the Disconnection Detection Flag. *10				
Offset/gain adjustment	Supported		---		
Direct conversion	---		A/D conversion is performed and the converted value is refreshed when the ANALOG INPUT DIRECT CONVERSION instruction (AIDC) is executed. This instruction is supported by the CJ2H-CPU□□ (-EIP) CPU Units with unit version 1.1 or later, and CJ2M-CPU□□. CJ1, NJ501, and CP1H CPU Units and NSJ Controllers do not support direct conversion.		

\*1 Do not apply a voltage higher than 600 V to the terminal block when performing withstand voltage test on this Unit. Otherwise, internal elements may deteriorate.

\*2 Input signal ranges can be set for each input.

\*3 Voltage input or current input are chosen by using the voltage/current switch at the back of the terminal block.

\*4 To use a current input, connect the positive current input terminal and positive voltage input terminal with the enclosed short bar.

\*5 The Analog Input Unit must be operated according to the input specifications provided here. Operating the Unit outside these specifications will cause the Unit to malfunction.

\*6 The resolution can be set to 8,000 and the conversion period to 250 μs in the setting. There is only one setting for both of these, i.e., they are both enabled or disabled together.

\*7 The accuracy is given for full scale. For example, an accuracy of ±0.2% means a maximum error of ±8 (BCD) at a resolution of 4,000. For the CJ1W-AD041-V1/ AD081-V1, the default setting is adjusted for voltage input. To use current input, perform the offset and gain adjustments as required.

\*8 For the CJ1W-AD041-V1/ AD081-V1, 23±2°C.

\*9 The A/D conversion period is the time required from when the Analog Input Unit receives the analog signal until it stores the converted value in internal memory. It takes at least one cycle for the converted data to be stored in the CPU Unit. (The direct conversion function of the CJ1W-AD042 is can be used to input data immediately to the CPU Unit.)

\*10 Line disconnection detection is supported only when the range is set to 1 to 5 V or 4 to 20 mA. If there is no input signal when the 1 to 5 V or 4 to 20 mA range is set, the Line Disconnection Flag will turn ON.

## Analog Output Units CJ1W-DA021/DA041/DA08V/DA08C/DA042V

## Specifications

Item	CJ1W-DA021	CJ1W-DA041	CJ1W-DA08V	CJ1W-DA08C	CJ1W-DA042V		
Unit type	CJ-series Special I/O Unit						
Isolation *1	Between I/O and Controller signals: Photocoupler (No isolation between I/O signals.)			Between I/O and Controller signals: Digital isolator (No isolation between I/O signals.)			
External terminals	18-point detachable terminal block (M3 screws)						
Power consumption	5 VDC, 120 mA max.		5 VDC, 140 mA max.		5 VDC, 400 mA max.		
External power supply *2	24 VDC <sup>+10%</sup> / <sub>-15%</sub> (inrush current: 20 A max., pulse width: 1 ms min.)				---		
	140 mA max.	200 mA max.	140 mA max.	170 mA max.	---		
Dimensions (mm)	31 × 90 × 65 mm (W × H × D)						
Weight	150 g max.						
General specifications	Conforms to general specifications for CJ-series Series.						
Output specifications	Number of analog outputs	2	4	8	8	4	
	Output signal range *3	1 to 5 V/4 to 20 mA 0 to 5 V 0 to 10 V -10 to 10 V		1 to 5 V 0 to 5 V 0 to 10 V -10 to 10 V	4 to 20 mA	1 to 5 V 0 to 10 V -10 to 10 V	
	Output impedance	0.5 Ω max. (for voltage output)		0.5 Ω max. (for voltage output)	---	0.5 Ω max. (for voltage output)	
	Max. output current (for 1 point)	12 mA (for voltage output)		2.4 mA (for voltage output)	---	2 mA (for voltage output)	
	Maximum permissible load resistance	600 Ω (current output)		---	350 Ω	---	
	Resolution	4,000		4,000/8,000 *8		1 to 5 V 0 to 10 V -10 to 10 V	10,000 20,000 40,000
	Set data	16-bit binary data					
	Accuracy *4	25°C	Voltage output: ±0.3% of F.S. Current output: ±0.5% of F.S.		±0.3% of F.S.	±0.3% of F.S.	±0.3% of F.S.
		0°C to 55°C	Voltage output: ±0.5% of F.S. Current output: ±0.8% of F.S.		±0.5% of F.S.	±0.6% of F.S.	±0.5% of F.S.
	D/A conversion period *5	1.0 ms per point		1.0 ms or 250 μs per point *8		20 μs/1 point, 25 μs/2 points, 30 μs/3 points, 35 μs/4 points	
Output functions	Output hold function	Outputs the specified output status (CLR, HOLD, or MAX) under any of the following circumstances. <ul style="list-style-type: none"> <li>• When the Conversion Enable Bit is OFF. *6</li> <li>• In adjustment mode, when a value other than the output number is output during adjustment. *7</li> <li>• When output setting value error occurs or Controller operation stops.</li> <li>• When the Load is OFF.</li> </ul>					
	Scaling	---	Supported only for a conversion period of 1 ms and resolution of 4,000. Setting values in any specified unit within a range of ±32,000 as the upper and lower limits allows D/A conversion to be executed and analog signals to be output with these values as full scale.		Setting values in any specified unit within a range of ±32,000 as the upper and lower limits allows D/A conversion to be executed and analog signals to be output with these values as full scale.		
	Offset/gain adjustment	Supported				---	
	Direct conversion	---				D/A conversion is performed and the output value is refreshed when the ANALOG OUTPUT DIRECT CONVERSION instruction (AODC) is executed. This instruction is supported by the CJ2H-CPU□□ (-EIP) CPU Units with unit version 1.1 or later, and CJ2M-CPU□□. CJ1, NJ501, and CP1H CPU Units and NSJ Controllers do not support direct conversion.	

\*1 Do not apply a voltage higher than 600 V to the terminal block when performing withstand voltage test on this Unit.

\*2 The maximum number of Analog Output Units that can be mounted to one Rack varies depending on the current consumption of the other Units mounted to the Rack.  
Select a 24 VDC power supply based on the surge current. The following OMRON external power supplies with a power rating of 50 W are recommended.

Manufacturer	Model number	Specifications
OMRON	S8VS-06024	100 to 240 VAC, 60 W
	S8VS-12024	100 to 240 VAC, 120 W

\*3 Output signal ranges can be set for each output.

\*4 The accuracy is given for full scale. For example, an accuracy of ±0.3% means a maximum error of ±60 mV for a -10 to 10 V range. For the CJ1W-DA021/041, the accuracy is at the factory setting for a current output. When using a voltage output, adjust the offset gain as required.

- \*5 The D/A conversion period is the time required for the Analog Output Unit to convert and output the data that was received from the CPU Unit. It takes at least one cycle for the data stored in the CPU Unit to be read by the Analog Output Unit. (The direct conversion function of the CJ1W-DA042V can be used to output data immediately from the CPU Unit.)
- \*6 When the operation mode for the CPU Unit is changed from RUN mode or MONITOR mode to PROGRAM mode, or when the power is turned ON, the Output Conversion Enable Bit will turn OFF. The output status specified according to the output hold function will be output.
- \*7 The CJ1W-DA042V does not have an Adjustment Mode.
- \*8 The CJ1W-DA08V/08C can be set to a conversion cycle of 250  $\mu$ s and a resolution of 8,000 using the setting.

## Analog I/O Unit CJ1W-MAD42

### Specifications

Item	CJ1W-MAD42
Unit type	CJ-series Special I/O Unit
Isolation	Between I/O and Controller signals: Photocoupler (No isolation between I/O signals.)
External terminals	18-point detachable terminal block (M3 screws)
Current consumption	580 mA max. at 5 V DC
Dimensions (mm)	31 × 90 × 65 mm (W × H × D)
Weight	150 g max.
General specifications	Conforms to general specifications for CJ-series Series.

### Input Specifications and Functions

Item	Voltage input	Current input
Number of analog inputs	4	
Input signal range *1	1 to 5 V 0 to 5 V 0 to 10 V -10 to 10 V	4 to 20 mA *2
Maximum rated input (for 1 point) *3	±15 V	±30 mA
Input impedance	1 M $\Omega$ min.	250 $\Omega$ (rated value)
Resolution	4,000/8,000 *7	
Converted output data	16-bit binary data	
Accuracy *4	25°C	±0.2% of F.S.
	0°C to 55°C	±0.4% of F.S.
A/D conversion period *5	1.0 ms/500 $\mu$ s per point *7	
Mean value processing	Stores the last "n" data conversions in the buffer, and stores the mean value of the conversion values. Buffer number: n = 2, 4, 8, 16, 32, 64	
Peak value holding	Stores the maximum conversion value while the Peak Value Hold Bit is ON.	
Scaling	Enabled only for conversion period of 1 ms and resolution of 4,000. Setting any values within a range of ±32,000 as the upper and lower limits allows the A/D conversion result to be output with these values as full scale.	
Input disconnection detection	Detects the disconnection and turns ON the Disconnection Detection Flag.	
Offset/gain adjustment	Supported	

## Output Specifications

Item		Voltage output	Current output
Number of analog outputs		2	
Output signal range *1		1 to 5 V 0 to 5 V 0 to 10 V -10 to 10 V	4 to 20 mA
Output impedance		0.5 Ω max.	-
Maximum external output current (for 1 point)		2.4 mA	-
Maximum allowed load resistance		-	600 Ω
Resolution		4,000/8,000 *7	
Set data		16-bit binary data	
Accuracy *4	25°C	±0.3% of F.S.	±0.3% of F.S.
	0°C to 55°C	±0.5% of F.S.	±0.6% of F.S.
D/A conversion period *5		1.0 ms/500 μs per point	
Output hold function		Outputs the specified output status (CLR, HOLD, or MAX) under any of the following circumstances. <ul style="list-style-type: none"> <li>• When the Conversion Enable Bit is OFF. *6</li> <li>• In adjustment mode, when a value other than the output number is output during adjustment.</li> <li>• When output setting value error occurs or Controller operation stops.</li> <li>• When the Load is OFF.</li> </ul>	
Scaling		Enabled only for conversion period or 1 ms and resolution of 4,000. Setting any values within a range of ±32,000 as the upper and lower limits allows D/A conversion to be executed and analog signals to be output with these values as full scale.	
Ratio conversion function *5		Stores the results of positive and negative gradient analog inputs calculated for ratio and bias as analog output values. Positive gradient: Analog output = A × Analog input + B (A: 0 to 99.99, B: 8000 to 7FFF hex) Negative gradient: Analog output = F - A × Analog input + B (A: 0 to 99.99, B: 8000 to 7FFF hex, F: Output range maximum value)	
Offset/gain adjustment		Supported	

\*1 Input and output signal ranges can be set for each input and output.

\*2 Voltage input or current input are chosen by using the voltage/current switch at the back of the terminal block.

\*3 The Analog I/O Unit must be operated according to the input specifications provided here. Operating the Unit outside these specifications will cause the Unit to malfunction.

\*4 The accuracy is given for full scale. For example, for an input, an accuracy of ±0.2% means a maximum error of ±8 (BCD) at a resolution of 4,000. For an output, an accuracy of ±0.3% means a maximum error of ±60 mV for a -10 to 10 V range.

\*5 The A/D conversion period is the time required from when the Analog Input Unit receives the analog signal until it stores the converted value in internal memory. It takes at least one cycle for the converted data to be stored in the CPU Unit.

The D/A conversion period is the time required for the Analog Output Unit to convert and output the data that was received from the CPU Unit. It takes at least one cycle for the data stored in the CPU Unit to be read by the Analog Output Unit.

\*6 When the operation mode for the CPU Unit is changed from RUN mode or MONITOR mode to PROGRAM mode, or when the power is turned ON, the Output Conversion Enable Bit will turn OFF. The output status specified according to the output hold function will be output.

\*7 By means of the setting, the resolution can be changed to 8,000, and the conversion period can be changed to 500 μs.

## External Interface

### Analog Input Units CJ1W-AD041-V1/AD081-V1/AD042 Components

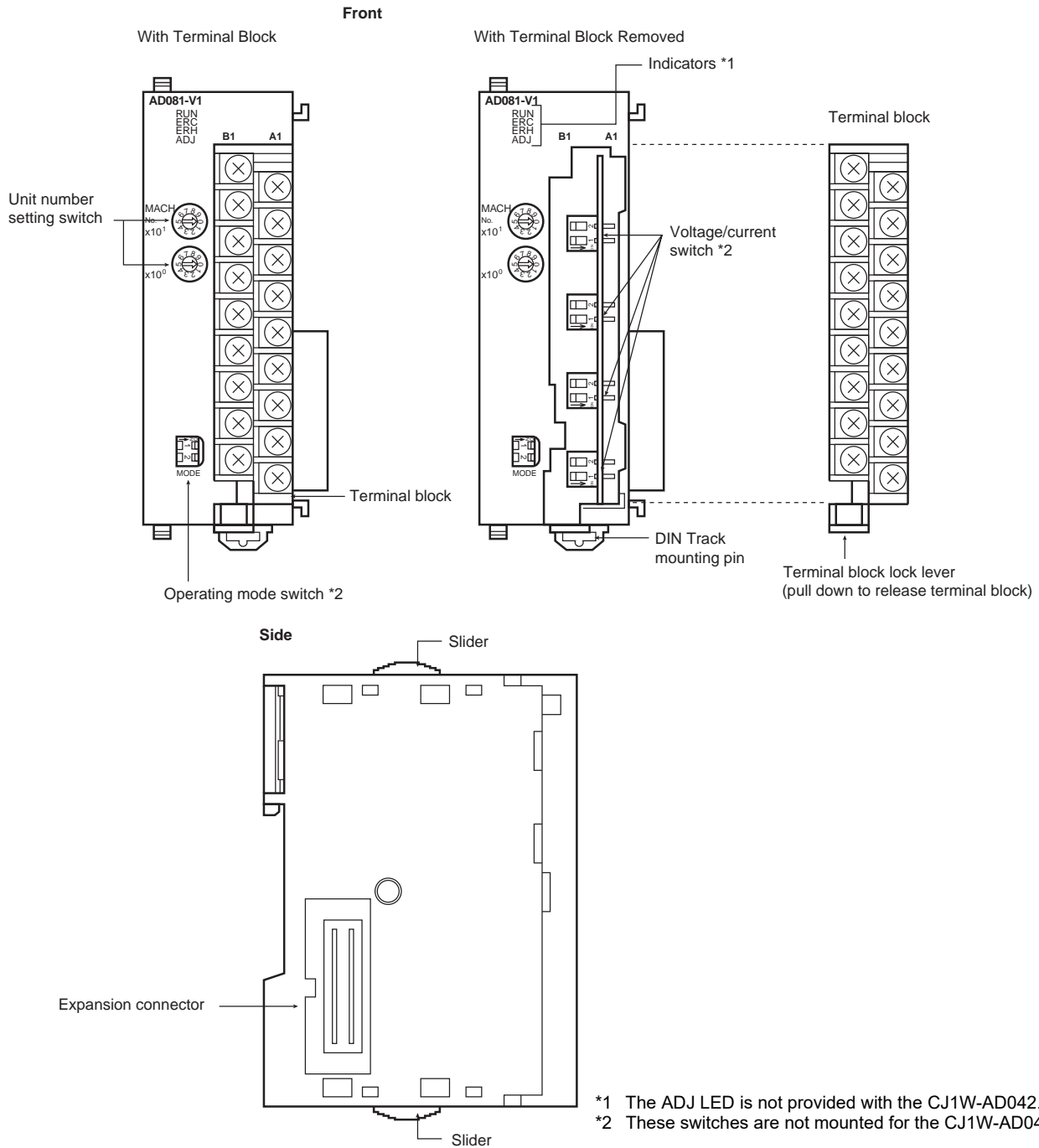

### Indicators

The indicators show the operating status of the Unit. The following table shows the meanings of the indicators.

LED	Meaning	Indicator	Operating status
RUN (green)	Operating	Lit	Operating in normal mode.
		Not lit	Unit has stopped exchanging data with the CPU Unit.
ERC (red)	Error detected by Unit	Lit	Alarm has occurred (such as disconnection detection) or initial settings are incorrect.
		Not lit	Operating normally.
ERH (red)	Error in the CPU Unit	Lit	Error has occurred during data exchange with the CPU Unit.
		Not lit	Operating normally.
ADJ (yellow) *	Adjusting	Flashing	Operating in offset/gain adjustment mode.
		Not lit	Other than the above.

\* The ADJ LED is not provided with the CJ1W-AD042.



## Input Circuits

The following diagrams show the internal circuit of the analog input section.

### CJ1W-AD041-V1/AD081-V1

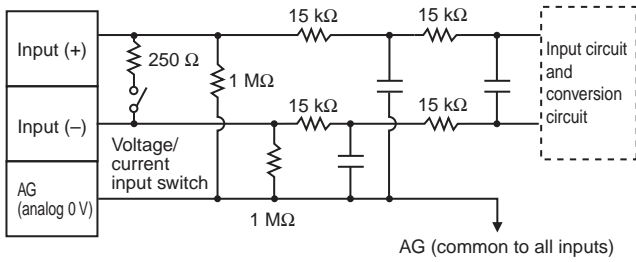

### CJ1W-AD042

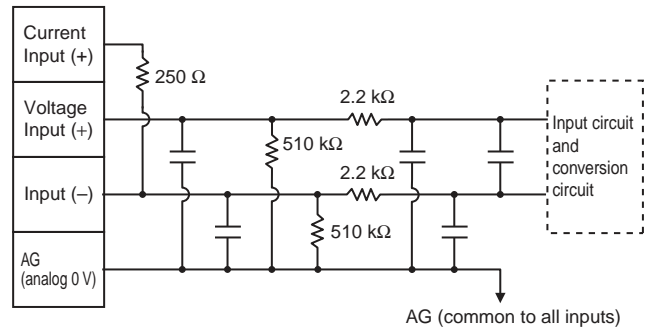

## Terminal Arrangement

The signal names corresponding to the connecting terminals are as shown in the following diagram.

### CJ1W-AD041-V1

Input 2 (+)	B1	A1	Input 1 (+)
Input 2 (-)	B2	A2	Input 1 (-)
Input 4 (+)	B3	A3	Input 3 (+)
Input 4 (-)	B4	A4	Input 3 (-)
AG	B5	A5	AG
N.C.	B6	A6	N.C.
N.C.	B7	A7	N.C.
N.C.	B8	A8	N.C.
N.C.	B9	A9	N.C.

### CJ1W-AD081-V1

Input 2 (+)	B1	A1	Input 1 (+)
Input 2 (-)	B2	A2	Input 1 (-)
Input 4 (+)	B3	A3	Input 3 (+)
Input 4 (-)	B4	A4	Input 3 (-)
AG	B5	A5	AG
Input 6 (+)	B6	A6	Input 5 (+)
Input 6 (-)	B7	A7	Input 5 (-)
Input 8 (+)	B8	A8	Input 7 (+)
Input 8 (-)	B9	A9	Input 7 (-)

### CJ1W-AD042

Current Input 2 (+)	B1	A1	Current Input 1 (+)
Voltage Input 2 (+)	B2	A2	Voltage Input 1 (+)
Input 2 (-)	B3	A3	Input 1 (-)
AG	B4	A4	AG
Current Input 4 (+)	B5	A5	Current Input 3 (+)
Voltage Input 4 (+)	B6	A6	Voltage Input 3 (+)
Input 4 (-)	B7	A7	Input 3 (-)
AG	B8	A8	AG
N.C.	B9	A9	N.C.

- Note:**
1. Set the analog input number that you use and input signal range for each analog input, using the memory area or support software. The input signal range can be set separately for each input number.
  2. The AG terminals are connected to the 0 V analog circuit in the Unit. Connecting shielded input lines can improve noise resistance.
  3. Do not connect anything to NC terminals.
  4. To use a current input with the CJ1W-AD042, connect the positive current input terminal and positive voltage input terminal with the enclosed short bar.
  5. Connect a surge suppressor to inductive loads in the system (e.g., magnetic contactors, relays, and solenoids).

## Analog Output Units CJ1W-DA021/041/08V/08C/DA042V Components

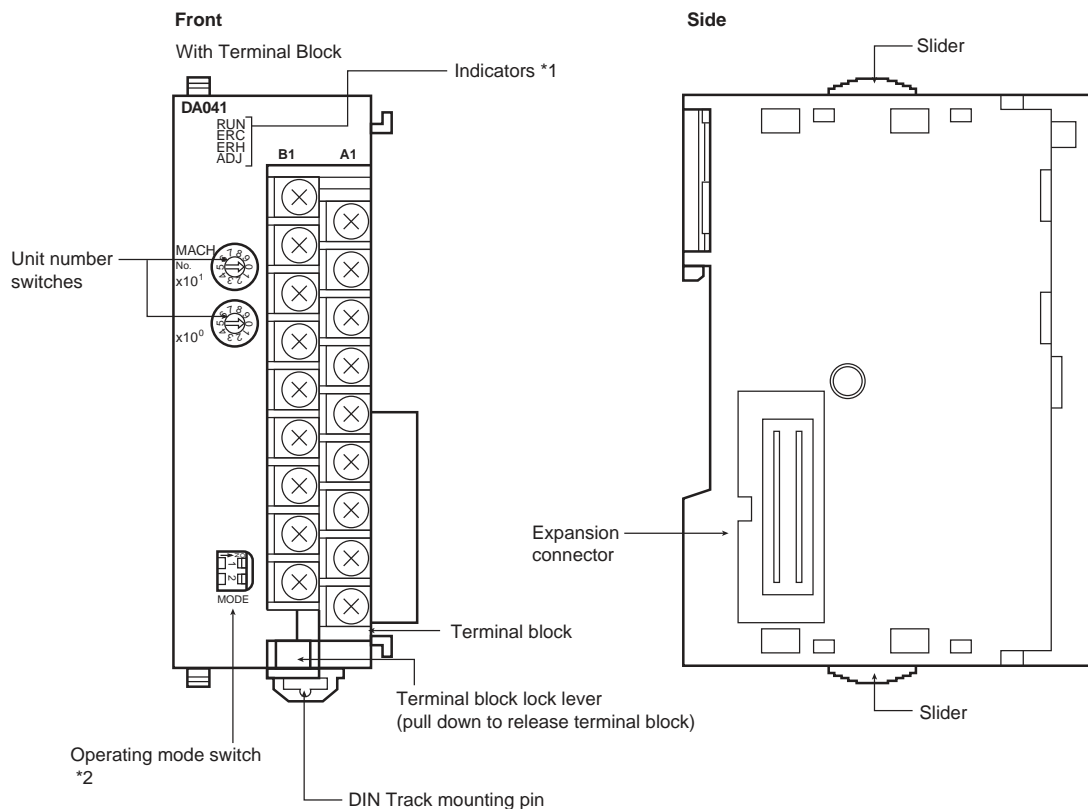

\*1 The ADJ LED is not provided with the CJ1W-DA042V.

\*2 This switch is not mounted for the CJ1W-DA08V, CJ1W-DA08C and CJ1W-DA042V.

### Indicators

The indicators show the operating status of the Unit. The following table shows the meanings of the indicators.

LED	Meaning	Indicator	Operating status
RUN (green)	Operating	Lit	Operating in normal mode.
		Not lit	Unit has stopped exchanging data with the CPU Unit.
ERC (red)	Error detected by Unit	Lit	Alarm has occurred or initial settings are incorrect.
		Not lit	Operating normally.
ERH (red)	Error in the CPU Unit	Lit	Error has occurred during data exchange with the CPU Unit.
		Not lit	Operating normally.
ADJ (yellow) *	Adjusting	Flashing	Operating in offset/gain adjustment mode.
		Not lit	Other than the above.

\* The ADJ LED is not provided with the CJ1W-DA042V.

## Output Circuits

The following diagrams show the internal circuit of the analog output section.

### CJ1W-DA021/DA041/DA08V/DA08C

#### Voltage Output Circuits

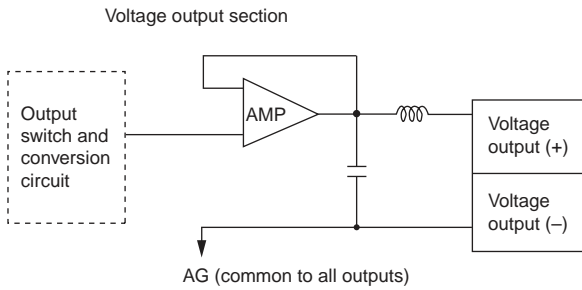

#### Current Output Circuits

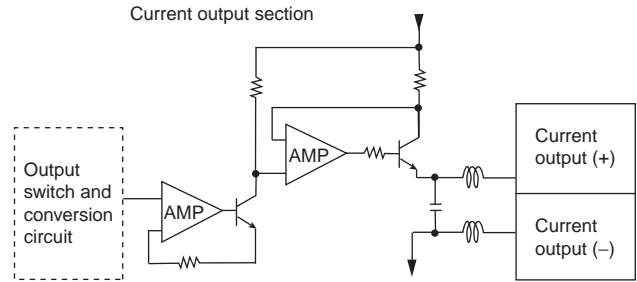

### CJ1W-DA042V

#### Voltage Output Circuits

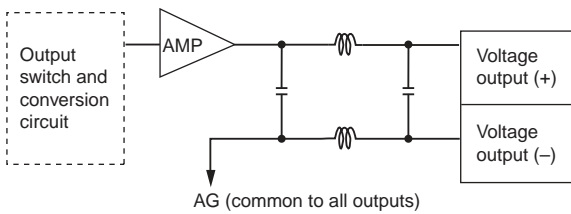

## Terminal Arrangement

The signal names corresponding to the connecting terminals are as shown in the following diagram.

#### CJ1W-DA021

Voltage output 2 (+)	B1	A1	Voltage output 1 (+)
Output 2 (-)	B2	A2	Output 1 (-)
Current output 2 (+)	B3	A3	Current output 1 (+)
N.C.	B4	A4	N.C.
N.C.	B5	A5	N.C.
N.C.	B6	A6	N.C.
N.C.	B7	A7	N.C.
N.C.	B8	A8	N.C.
0 V	B9	A9	24 V

#### CJ1W-DA041

Voltage output 2 (+)	B1	A1	Voltage output 1 (+)
Output 2 (-)	B2	A2	Output 1 (-)
Current output 2 (+)	B3	A3	Current output 1 (+)
Voltage output 4 (+)	B4	A4	Voltage output 3 (+)
Output 4 (-)	B5	A5	Output 3 (-)
Current output 4 (+)	B6	A6	Current output 3 (+)
N.C.	B7	A7	N.C.
N.C.	B8	A8	N.C.
0 V	B9	A9	24 V

#### CJ1W-DA08V (Voltage Output) and CJ1W-DA08C (Current Output)

Output 2 (+)	B1	A1	Output 1 (+)
Output 2 (-)	B2	A2	Output 1 (-)
Output 4 (+)	B3	A3	Output 3 (+)
Output 4 (-)	B4	A4	Output 3 (-)
Output 6 (+)	B5	A5	Output 5 (+)
Output 6 (-)	B6	A6	Output 5 (-)
Output 8 (+)	B7	A7	Output 7 (+)
Output 8 (-)	B8	A8	Output 7 (-)
0 V	B9	A9	24 V

#### CJ1W-DA042V

Output 2 (+)	B1	A1	Output 1 (+)
Output 2 (-)	B2	A2	Output 1 (-)
N.C.	B3	A3	N.C.
Output 4 (+)	B4	A4	Output 3 (+)
Output 4 (-)	B5	A5	Output 3 (-)
N.C.	B6	A6	N.C.
N.C.	B7	A7	N.C.
N.C.	B8	A8	N.C.
N.C.	B9	A9	N.C.

- Note: 1.** Set the analog input number that you use and input signal range for each analog input, using the memory area or support software. The input signal range can be set separately for each input number.
- 2.** The N.C. terminals are not connected to internal circuit.
- 3.** A9 (24 V) and B9 (0 V) are the power supply input terminals. Power must be supplied from an external source. (This does not apply to CJ1W-DA042V.)
- 4.** Use a separate power supply from the one used for Basic I/O Units. Faulty Unit operation may be caused by noise if power is supplied from the same source. (This does not apply to CJ1W-DA042V.)
- 5.** Connect a surge suppressor to inductive loads in the system (e.g., magnetic contactors, relays, and solenoids).

## Analog I/O Unit CJ1W-MAD42 Components

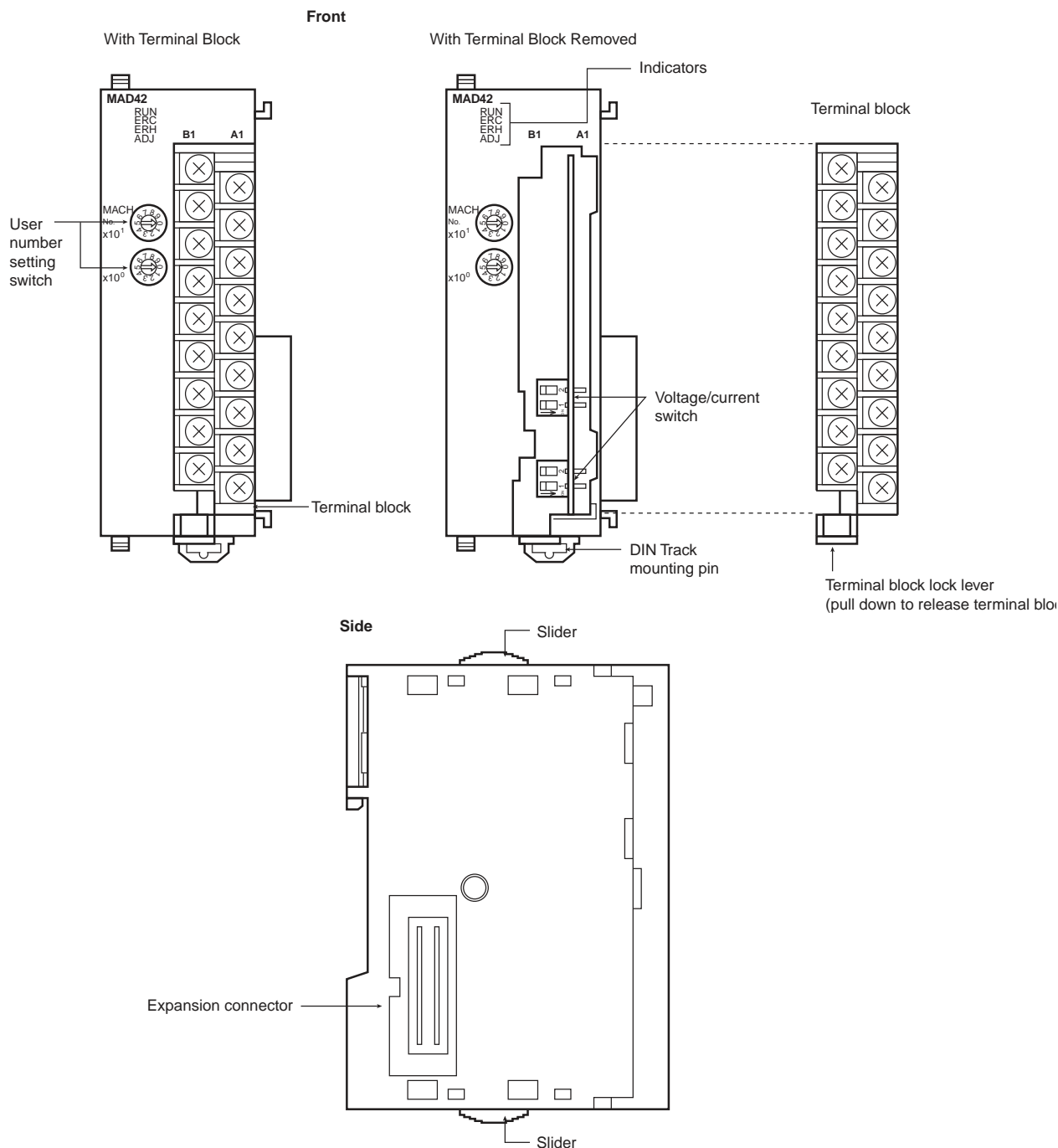

### Indicators

The indicators show the operating status of the Unit. The following table shows the meanings of the indicators.

LED	Meaning	Indicator	Operating status
RUN (green)	Operating	Lit	Operating in normal mode.
		Not lit	Unit has stopped exchanging data with the CPU Unit.
ERC (red)	Error detected by Unit	Lit	Alarm has occurred (such as disconnection detection) or initial settings are incorrect.
		Not lit	Operating normally.
ADJ (yellow)	Adjusting	Flashing	Operating in offset/gain adjustment mode.
		Not lit	Other than the above.
ERH (red)	Error in the CPU Unit	Lit	Error has occurred during data exchange with the CPU Unit.
		Not lit	Operating normally.

## I/O Circuit

The following diagrams show the internal circuit of the analog I/O section.

### Input Circuits

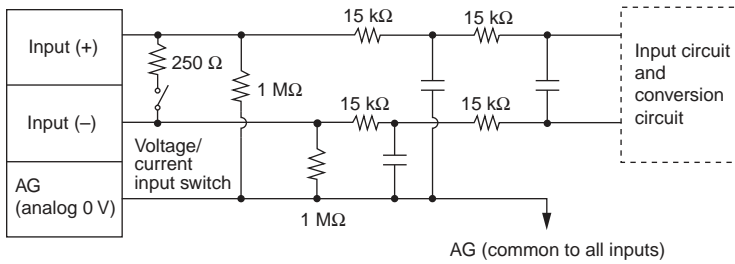

### Voltage Output Circuits

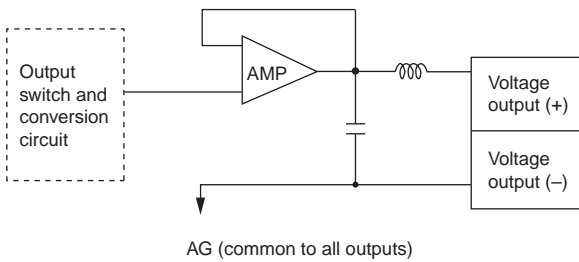

### Current Output Circuits

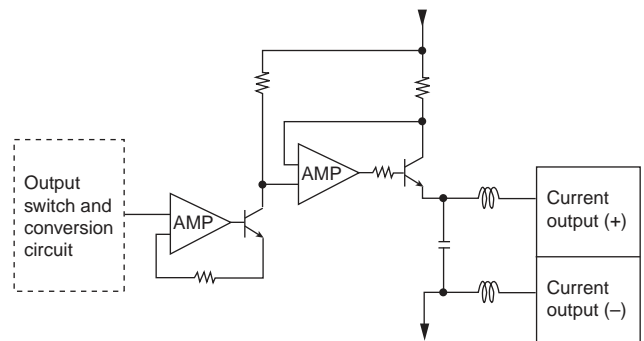

## Terminal Arrangement

The signal names corresponding to the connecting terminals are as shown in the following diagram.

### CJ1W-MAD42

Voltage output 2 (+)	B1	A1	Voltage output 1 (+)
Output 2 (-)	B2	A2	Output 1 (-)
Current output 2 (+)	B3	A3	Current output 1 (+)
N.C.	B4	A4	N.C.
Input 2 (+)	B5	A5	Input 1 (+)
Input 2 (-)	B6	A6	Input 1 (-)
AG	B7	A7	AG
Input 4 (+)	B8	A8	Input 3 (+)
Input 4 (-)	B9	A9	Input 3 (-)

- Note:**
1. Set the analog input number that you use and input signal range for each analog input, using the memory area or support software. The input signal range can be set separately for each input number.
  2. The AG terminal (A7, B7) is connected to the 0 V analog circuit in the Unit. Connecting shielded input lines can improve noise resistance.
  3. The N.C. terminals (A4, B4) are not connected to internal circuit.

## Wiring Vasic I/O Units with Terminal Blocks

### Crimp terminals

Use crimp terminals (M3) having the dimensions shown below.



# Dimensions

CJ1W-AD041-V1/081-V1/AD042  
 CJ1W-DA021/041/08V/08C/DA042V  
 CJ1W-MAD42

## Terminal Block Dimensions

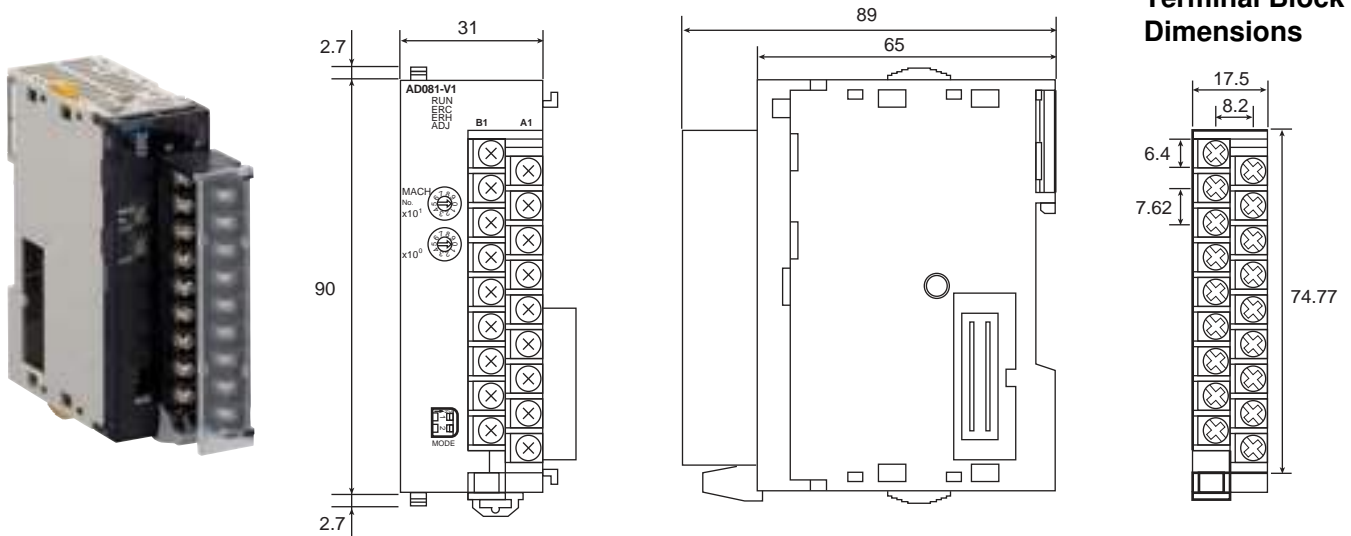

**Note:** The appearance varies with the model.

## Related Manuals

Manual name	Cat. No.	Manual name	Application	Description
CJ-series Analog I/O Units Operation Manual for NJ-series CPU Unit	W490	CJ1W-AD0□□-□□ CJ1W-DA0□□□ CJ1W-MAD42	Learning about the functions and usage of CJseries Analog Input Units, Analog Output Units, and Analog I/O Units for using them in an NJ-series configuration.	The functions and usage of the CJ-series Analog Input Units, Analog Output Units, and Analog I/O Units for using them in an NJ-series configuration are described.
CS/CJ Series Analog I/O Units Operation Manual	W345	CS1W-AD041-V1/081-V1/161 CS1W-DA041/08V/08C CS1W-MAD44 CJ1W-AD041-V1/081-V1/042 CJ1W-DA021/041/08V/08C/042V CJ1W-MAD42	Learning about the functions and usage of CJseries Analog Input Units, Analog Output Units, and Analog I/O Units.	The functions and usage of the CJ-series Analog Input Units, Analog Output Units, and Analog I/O Units for using them in a CJ-series configuration are described.

## Terms and Conditions Agreement

### Read and understand this catalog.

Please read and understand this catalog before purchasing the products. Please consult your OMRON representative if you have any questions or comments.

### Warranties.

(a) Exclusive Warranty. Omron's exclusive warranty is that the Products will be free from defects in materials and workmanship for a period of twelve months from the date of sale by Omron (or such other period expressed in writing by Omron). Omron disclaims all other warranties, express or implied.

(b) Limitations. OMRON MAKES NO WARRANTY OR REPRESENTATION, EXPRESS OR IMPLIED, ABOUT NON-INFRINGEMENT, MERCHANTABILITY OR FITNESS FOR A PARTICULAR PURPOSE OF THE PRODUCTS. BUYER ACKNOWLEDGES THAT IT ALONE HAS DETERMINED THAT THE PRODUCTS WILL SUITABLY MEET THE REQUIREMENTS OF THEIR INTENDED USE.

Omron further disclaims all warranties and responsibility of any type for claims or expenses based on infringement by the Products or otherwise of any intellectual property right. (c) Buyer Remedy. Omron's sole obligation hereunder shall be, at Omron's election, to (i) replace (in the form originally shipped with Buyer responsible for labor charges for removal or replacement thereof) the non-complying Product, (ii) repair the non-complying Product, or (iii) repay or credit Buyer an amount equal to the purchase price of the non-complying Product; provided that in no event shall Omron be responsible for warranty, repair, indemnity or any other claims or expenses regarding the Products unless Omron's analysis confirms that the Products were properly handled, stored, installed and maintained and not subject to contamination, abuse, misuse or inappropriate modification. Return of any Products by Buyer must be approved in writing by Omron before shipment. Omron Companies shall not be liable for the suitability or unsuitability or the results from the use of Products in combination with any electrical or electronic components, circuits, system assemblies or any other materials or substances or environments. Any advice, recommendations or information given orally or in writing, are not to be construed as an amendment or addition to the above warranty.

See <http://www.omron.com/global/> or contact your Omron representative for published information.

### Limitation on Liability: Etc.

OMRON COMPANIES SHALL NOT BE LIABLE FOR SPECIAL, INDIRECT, INCIDENTAL, OR CONSEQUENTIAL DAMAGES, LOSS OF PROFITS OR PRODUCTION OR COMMERCIAL LOSS IN ANY WAY CONNECTED WITH THE PRODUCTS, WHETHER SUCH CLAIM IS BASED IN CONTRACT, WARRANTY, NEGLIGENCE OR STRICT LIABILITY.

Further, in no event shall liability of Omron Companies exceed the individual price of the Product on which liability is asserted.

### Suitability of Use.

Omron Companies shall not be responsible for conformity with any standards, codes or regulations which apply to the combination of the Product in the Buyer's application or use of the Product. At Buyer's request, Omron will provide applicable third party certification documents identifying ratings and limitations of use which apply to the Product. This information by itself is not sufficient for a complete determination of the suitability of the Product in combination with the end product, machine, system, or other application or use. Buyer shall be solely responsible for determining appropriateness of the particular Product with respect to Buyer's application, product or system. Buyer shall take application responsibility in all cases.

NEVER USE THE PRODUCT FOR AN APPLICATION INVOLVING SERIOUS RISK TO LIFE OR PROPERTY OR IN LARGE QUANTITIES WITHOUT ENSURING THAT THE SYSTEM AS A WHOLE HAS BEEN DESIGNED TO ADDRESS THE RISKS, AND THAT THE OMRON PRODUCT(S) IS PROPERLY RATED AND INSTALLED FOR THE INTENDED USE WITHIN THE OVERALL EQUIPMENT OR SYSTEM.

### Programmable Products.

Omron Companies shall not be responsible for the user's programming of a programmable Product, or any consequence thereof.

### Performance Data.

Data presented in Omron Company websites, catalogs and other materials is provided as a guide for the user in determining suitability and does not constitute a warranty. It may represent the result of Omron's test conditions, and the user must correlate it to actual application requirements. Actual performance is subject to the Omron's Warranty and Limitations of Liability.

### Change in Specifications.

Product specifications and accessories may be changed at any time based on improvements and other reasons. It is our practice to change part numbers when published ratings or features are changed, or when significant construction changes are made. However, some specifications of the Product may be changed without any notice. When in doubt, special part numbers may be assigned to fix or establish key specifications for your application. Please consult with your Omron's representative at any time to confirm actual specifications of purchased Product.

### Errors and Omissions.

Information presented by Omron Companies has been checked and is believed to be accurate; however, no responsibility is assumed for clerical, typographical or proofreading errors or omissions.

2023.1

In the interest of product improvement, specifications are subject to change without notice.

**OMRON Corporation**  
Industrial Automation Company

<http://www.ia.omron.com/>

(c)Copyright OMRON Corporation 2023 All Right Reserved.