

**Xinger**<sup>®</sup>

**Ultra Low Profile 0805 Balun**  
**75Ω to 75Ω Balanced**

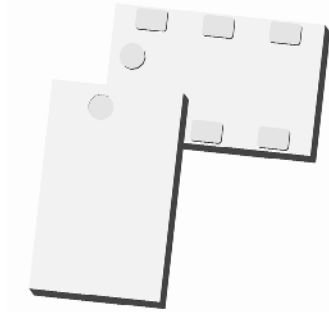

**Description:**

The B0225J7575AHF is a low profile sub-miniature balanced to unbalanced transformer designed for differential inputs and output locations on next generation wireless chipsets in an easy to use surface mount package covering the DVB-T, DVB-C and DVB-S broadcast frequencies. The B0225J7575AHF is ideal for high volume manufacturing and is higher performance than traditional wire wound and lumped element baluns. The B0225J7575AHF has an unbalanced port impedance of 75Ω and a 75Ω balanced port impedance. This transformation enables single ended signals to be applied to differential ports. The output ports have equal amplitude (-3dB) with 180 degree phase differential. The B0225J7575AHF is available on tape and reel for pick and place high volume manufacturing.

**Detailed Electrical Specifications:**

Specifications subject to change without notice.

Features:	Parameter	Broadband			Narrowband			25°C Unit
		Min	Typ	Max	Min	Typ	Max	
<ul style="list-style-type: none"> <li>• 200 – 2500 MHz</li> <li>• 0.7mm Height Profile</li> <li>• 75 Ohm to 2 x 37.5 Ohm</li> <li>• DVB-T, DVB-C &amp; DVB-S</li> <li>• Low Insertion Loss</li> <li>• Surface Mountable</li> <li>• Tape &amp; Reel</li> <li>• Non-conductive Surface</li> <li>• RoHS Compliant</li> <li>• Halogen Free</li> </ul>	Frequency	200		2500	350		550	MHz
	Unbalanced Port Impedance		75			75		Ω
	Balanced Port Impedance		75			75		Ω
	Return Loss	14	16		17	20		dB
	Insertion Loss*		0.9	1.2		0.4	0.5	dB
	Amplitude Balance		3.0	3.2		1.4	1.6	dB
	Phase Balance		38	40		24	26	Degrees
	CMRR		8			13		dB
	Power Handling			0.5			0.5	Watts
	Operating Temperature		-55		+85	-55		+85

Insertion Loss stated at room temperature (Insertion Loss is approximately 0.1 dB higher at +85 °C) Outline Drawing

**Outline Drawing:**

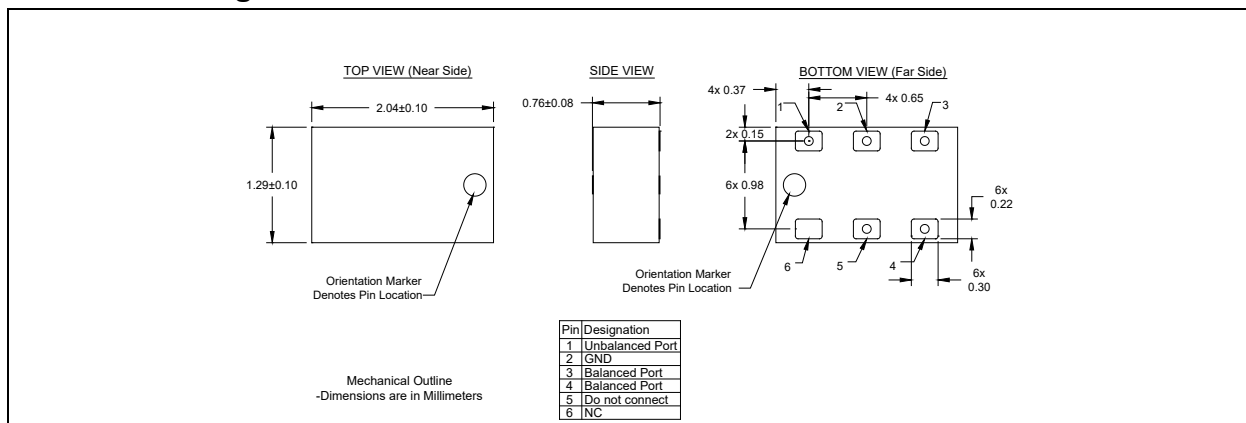

**Typical Performance: 10 MHz to 8010 MHz**

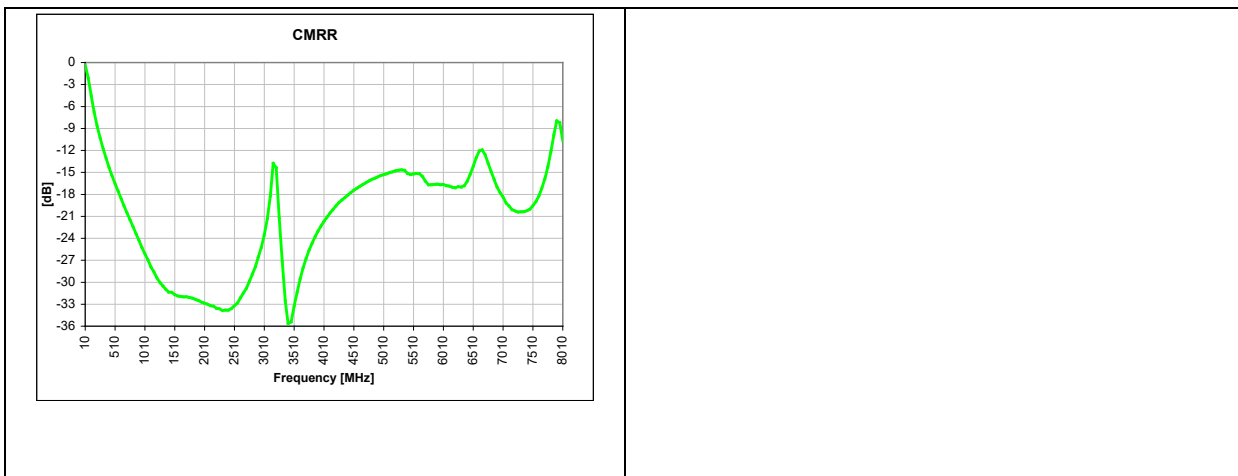
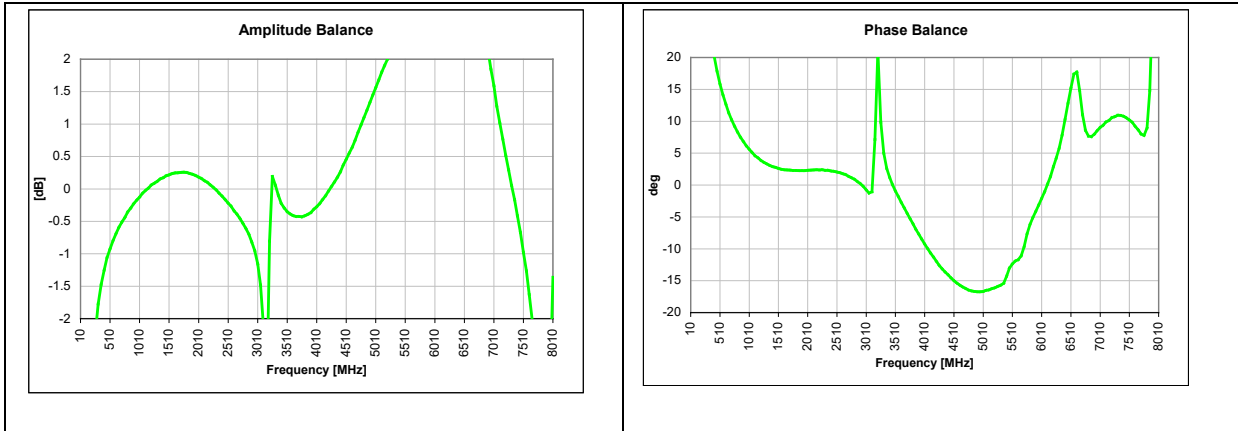
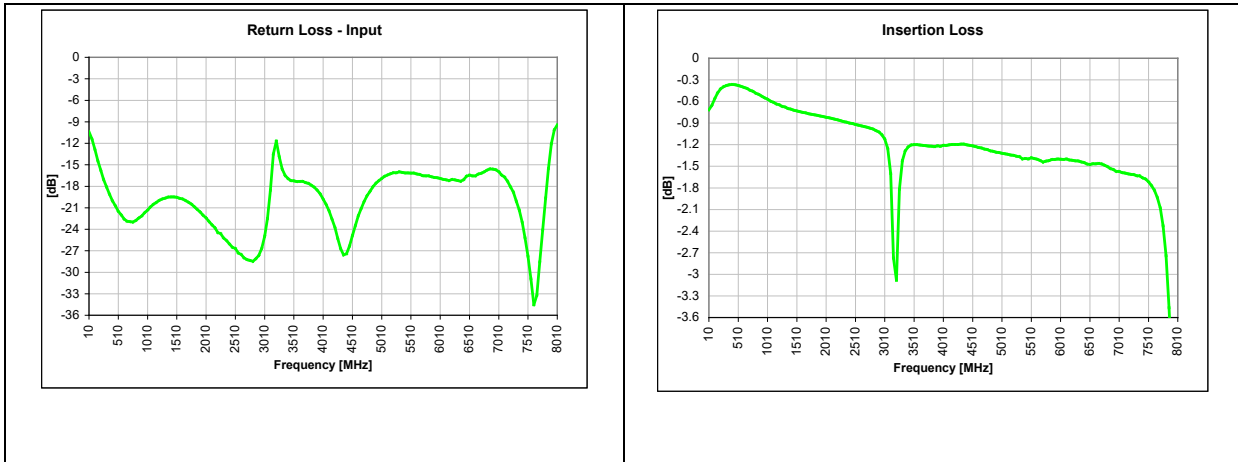

**Typical Performance: 150 MHz to 2550 MHz**

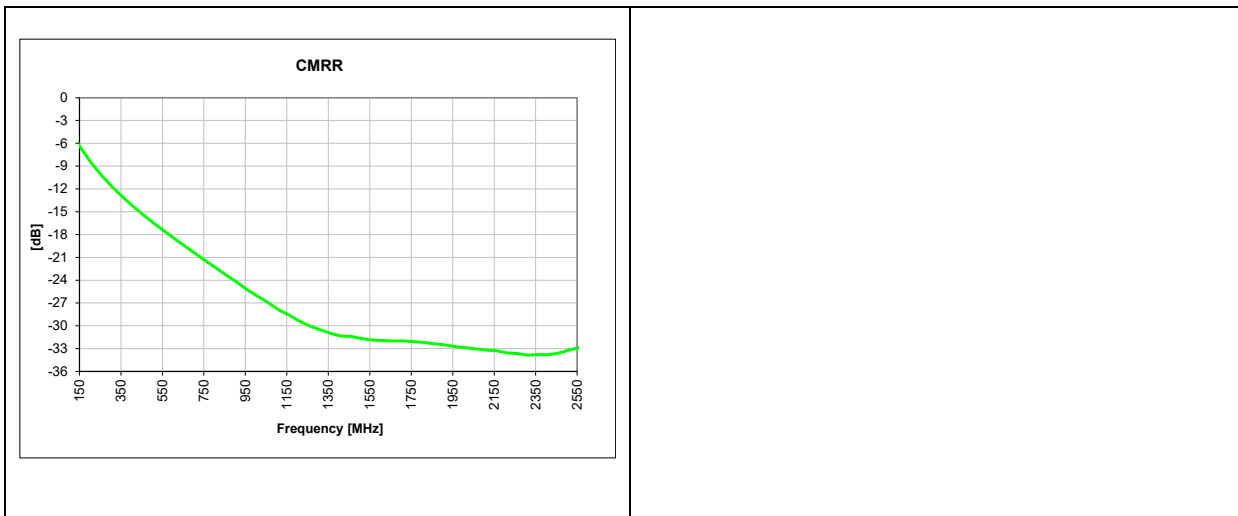
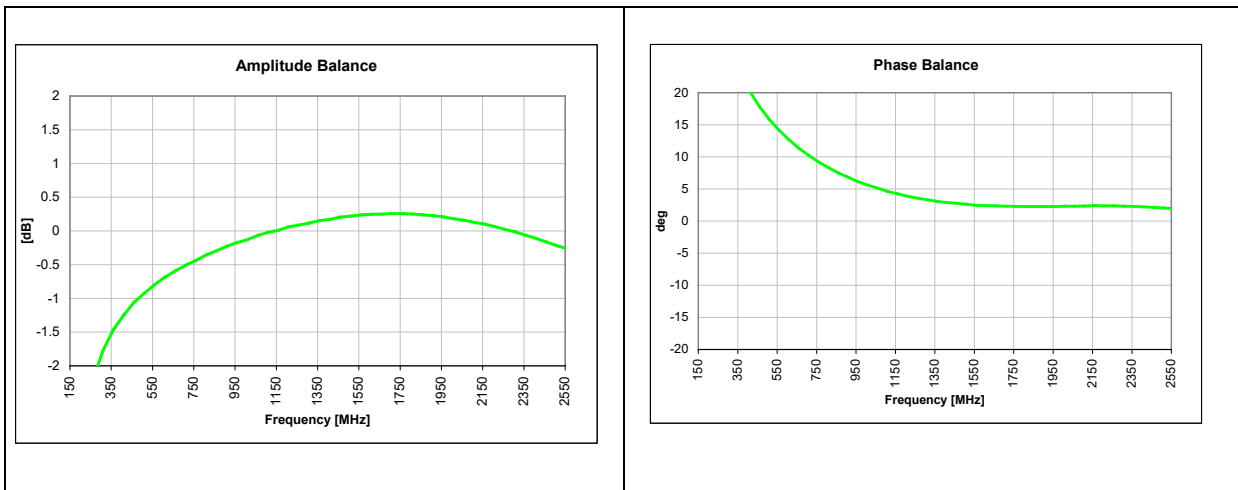
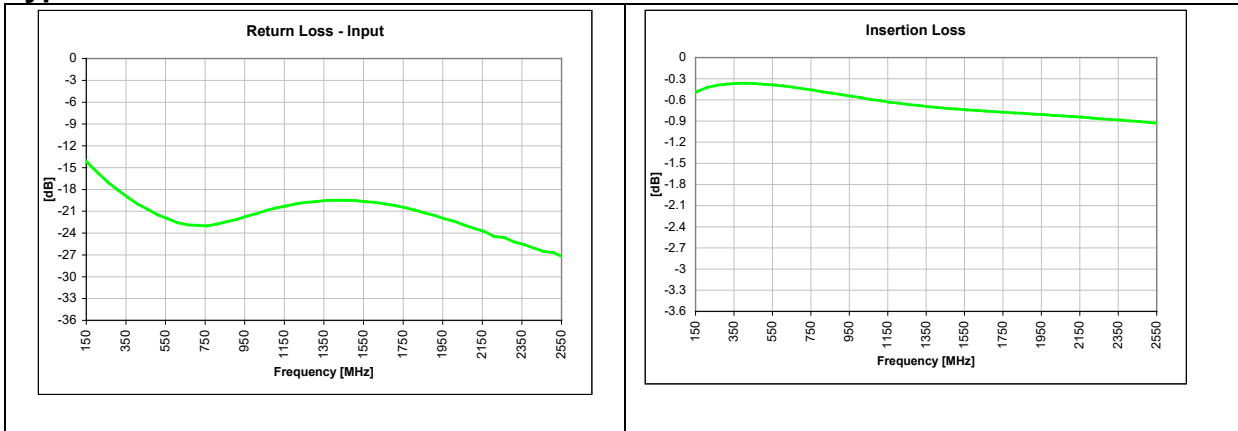

### Mounting Configuration:

In order for Xinger surface mount components to work optimally, the proper impedance transmission lines must be used to connect to the RF ports. If this condition is not satisfied, insertion loss, Isolation and VSWR may not meet published specifications.

All of the Xinger components are constructed from organic PTFE based composites which possess excellent electrical and mechanical stability. Xinger components are compliant to a variety of ROHS and Green standards and ready for Pb-free soldering processes. Pads are Gold plated with a Nickel barrier.

An example of the PCB footprint used in the testing of these parts is shown below. In specific designs, the transmission line widths need to be adjusted to the unique dielectric coefficients and thicknesses as well as varying pick and place equipment tolerances.

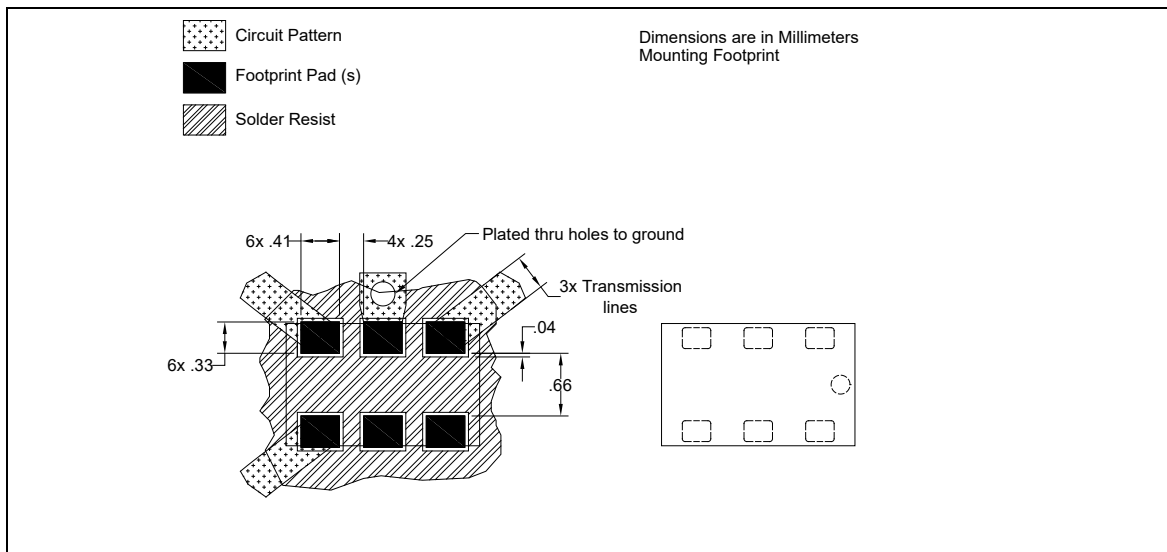

**Packaging and Ordering Information:**

Parts are available in reel and are packaged per EIA 481-2. Parts are oriented in tape and reel as shown below. Minimum order quantities are 4000 per reel. See Model Numbers below for further ordering information.

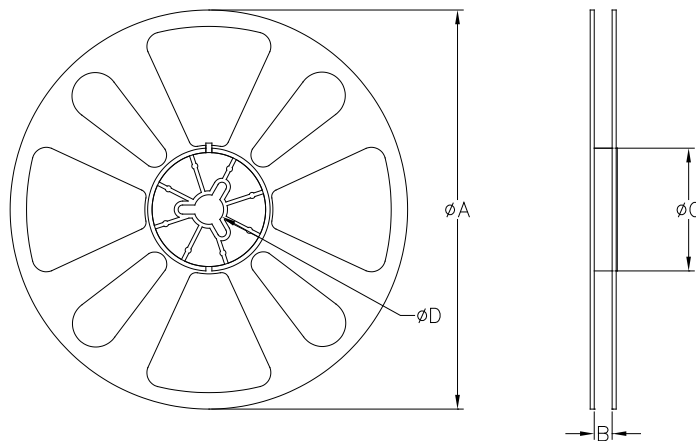
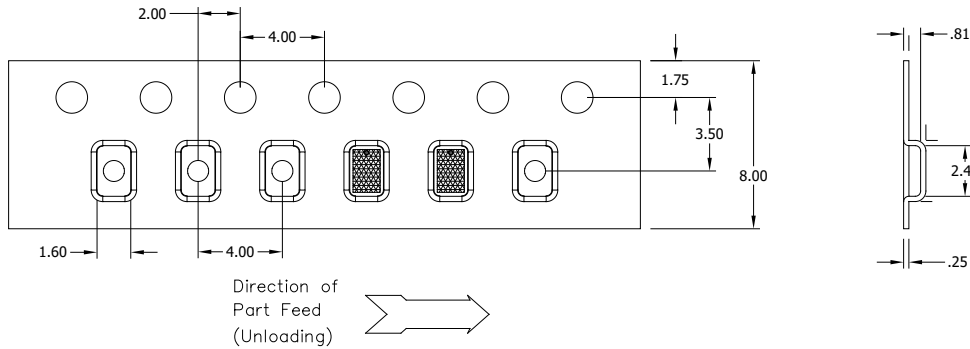

TABLE 1		
QUANTITY/REEL	REEL DIMENSIONS mm	
4000	φA	177.80
	B	8.00
	φC	50.80
	φD	13.00

**Contact us:**  
[rf&s\\_support@ttm.com](mailto:rf&s_support@ttm.com)