

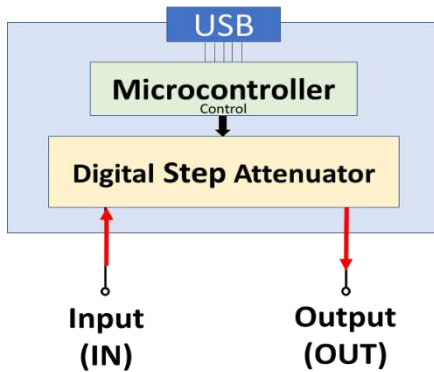

RoHS Compliant



Electrical Schematic

Insertion Loss Compensated

No Extra Insertion Loss

Setting Attenuation = Actual Attenuation

Note: When the "compensate I.L." is set "ON", and the frequency and wanted attenuation value is specified, the attenuator will automatically calculate the required additional attenuation value according to the corresponding insertion loss. The final attenuation value will be very close to wanted attenuation value.

Outline Drawing

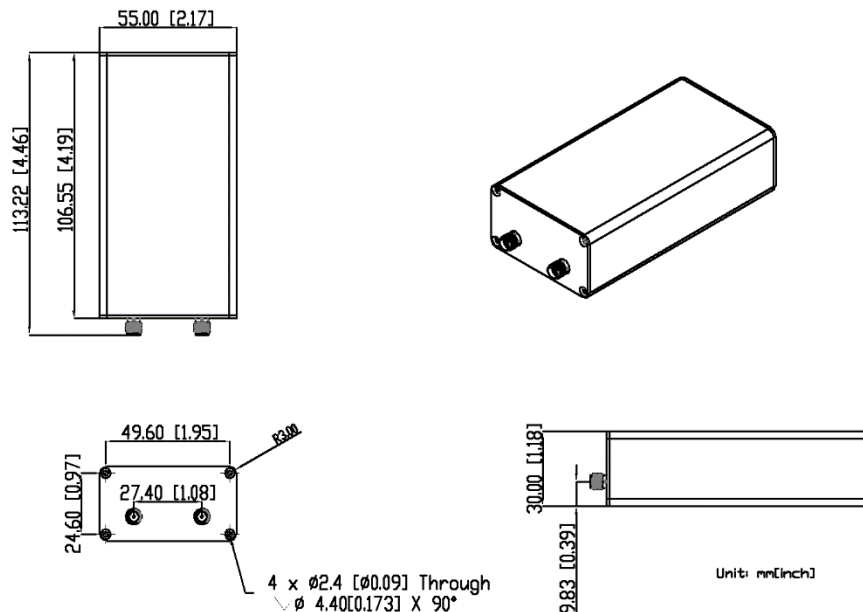

Connectors: SMA Female, USB (Micro-B)

Electrical Specifications

Parameter		Unit	Frequency (MHz)	Conditions	Min.	Typ.	Max.	
Attenuation Range		dB	15 - 12000		0		31.5	
Step		dB					0.5	
Insertion Loss (I.L.)		dB			@ 0 dB Att.		5.6	5.8
Attenuation Accuracy	Compensate I.L. "OFF" <i>Note1</i> (I.L. Excluded)	dB			@ 0.5 dB Att.		±0.19	±0.23
					@ 1, 2, 4, 8 dB Att.		±0.30	±0.33
					@ 16 dB Att.		±0.80	±0.90
	Compensate I.L. "ON" <i>Note2</i> (I.L. Included)	dB			@ 31.5 dB Att.		±1.84	±2.00
					I.L. ≤ Att. ≤ 16dB		± 0.50	± 0.70
					16dB < Att. ≤ 31.5dB		± 0.70	± 0.95
Input Operating Power (RF In and RF Out ports)		dBm						25
IP3 Input		dBm					36	
VSWR		:1			@ 0 dB Att.			
					Input		1.58	1.64
					Output		1.57	
Switching Speed		us		10% to 90% RF Output		45		
				50% Control to 90% RF Output		293		
Supply Voltage		V		USB port		5		
Supply Current		mA		USB port		13		

Operated in 50Ω system, 25°C environment.

Note1 Max accuracy is relative to attenuation setting value EXCLUDING insertion loss while "Compensate I.L." setting is "OFF".

Note 2 Max accuracy is relative to attenuation setting value INCLUDING insertion loss while "Compensate I.L." setting is "ON".

Attenuation relative to Insertion Loss

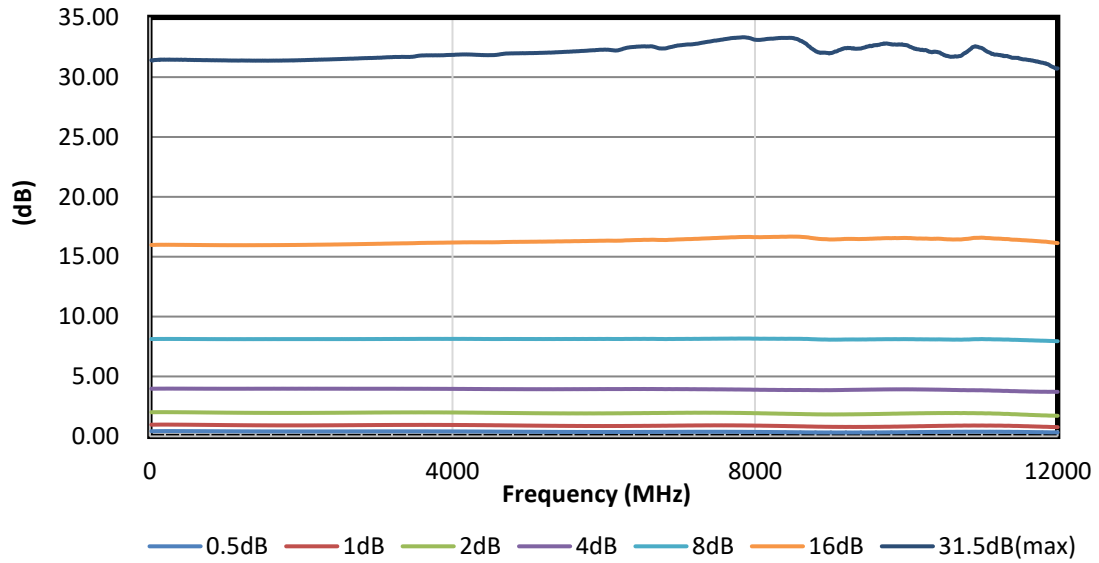

Insertion Loss

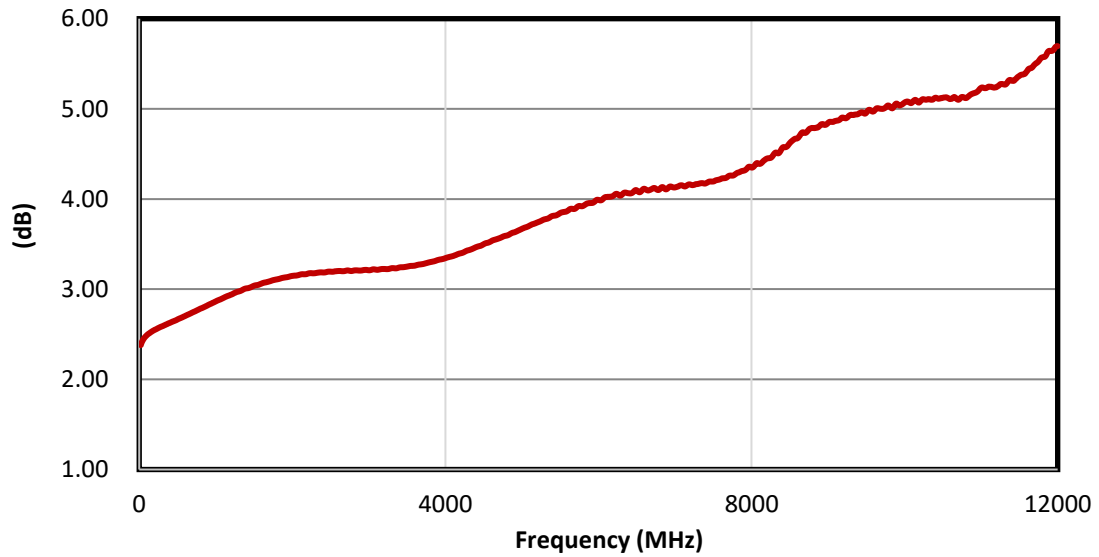

Input VSWR

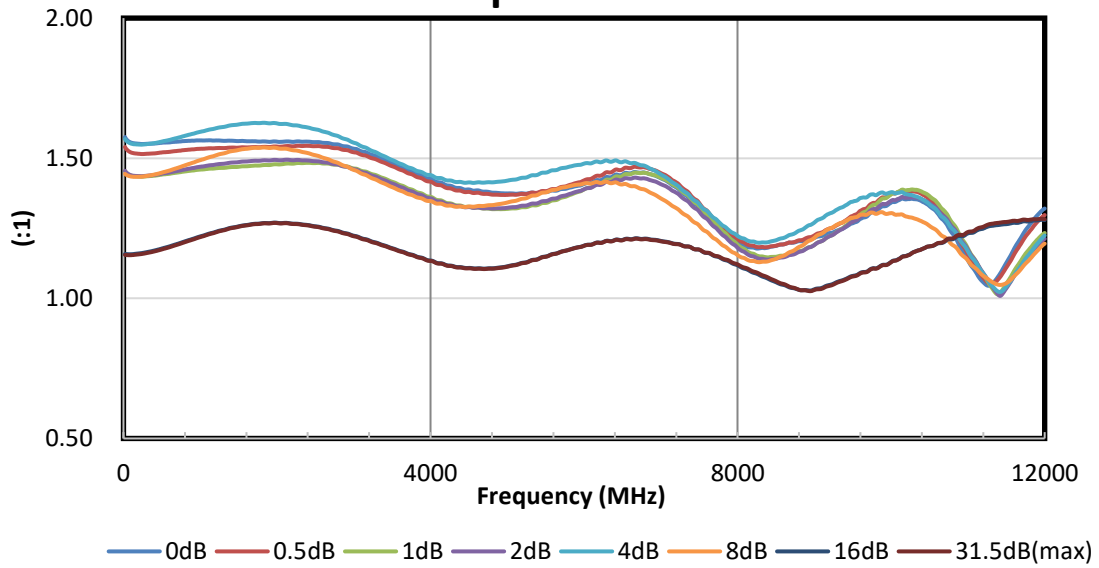

Output VSWR

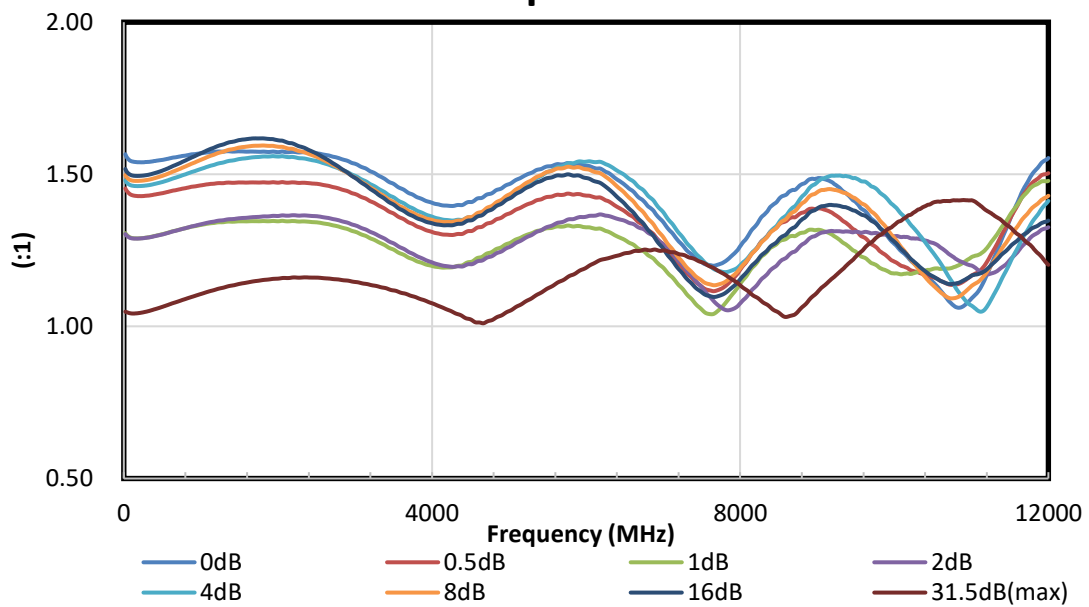

Typical Attenuation Accuracy

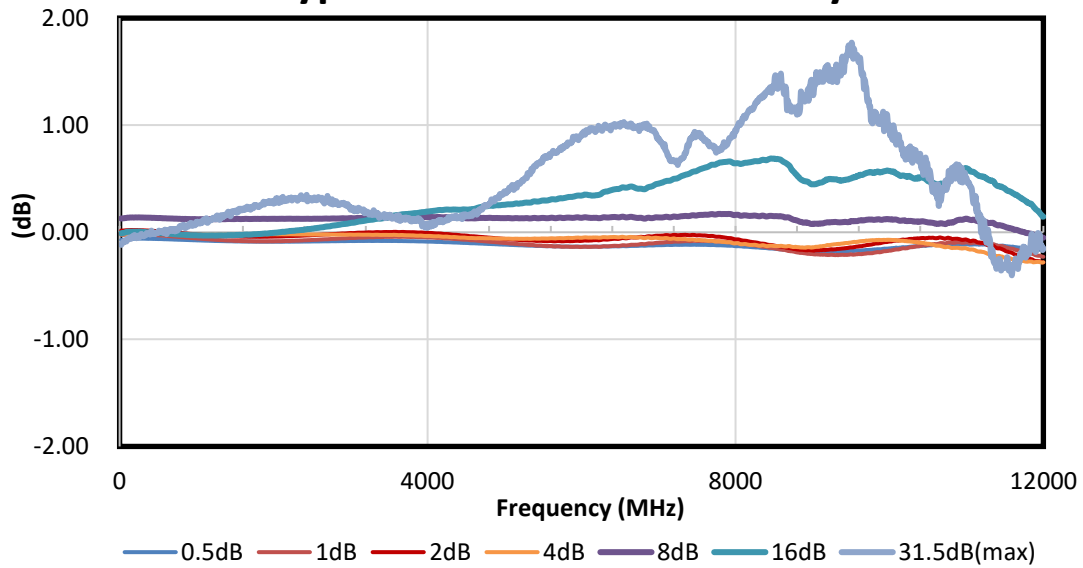

Amtery Graphical User Interface (GUI)

title and version number

pull down COM port selection

information column

attenuation setting value INCLUDING insertion loss while "Compensate I.L." setting is "ON"

information table: Users key-in desired setting here, and the device current setting also displayed.

four operation buttons

Channel	Attenuation (dB)	Frequency (MHz)	Compensate Insertion Loss
1	30	1000	<input checked="" type="checkbox"/>
			<input type="checkbox"/>
			<input type="checkbox"/>
			<input type="checkbox"/>

Software Support: <https://www.amtery.com/data/files/Software.zip>

User manual: <http://www.amtery.com/data/files/User%20Manual.pdf>

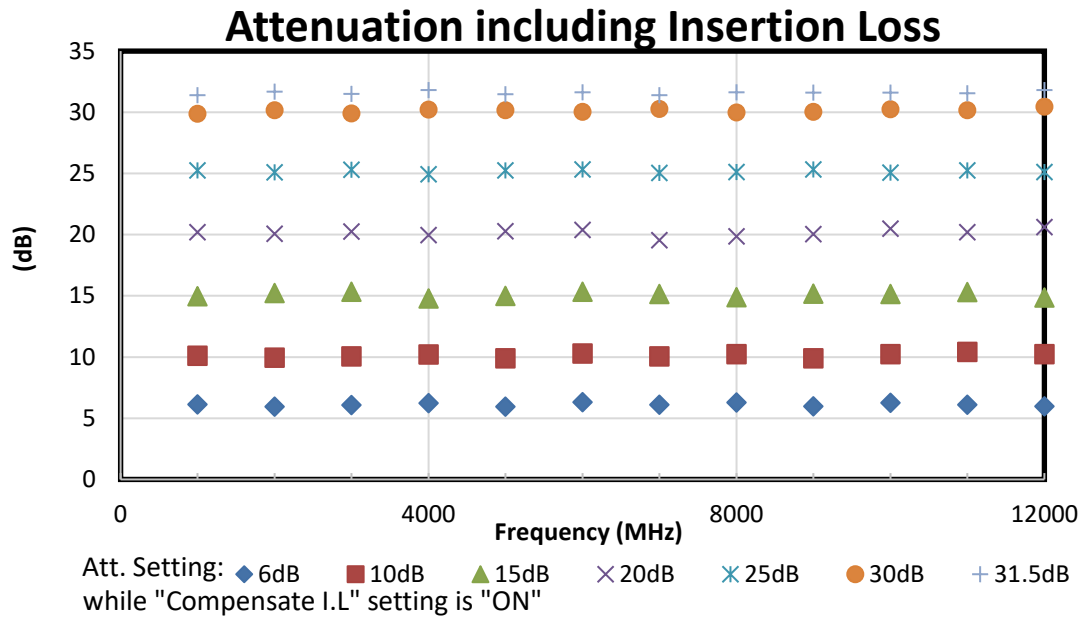

Typical Attenuation Accuracy with Insertion Loss Compensated

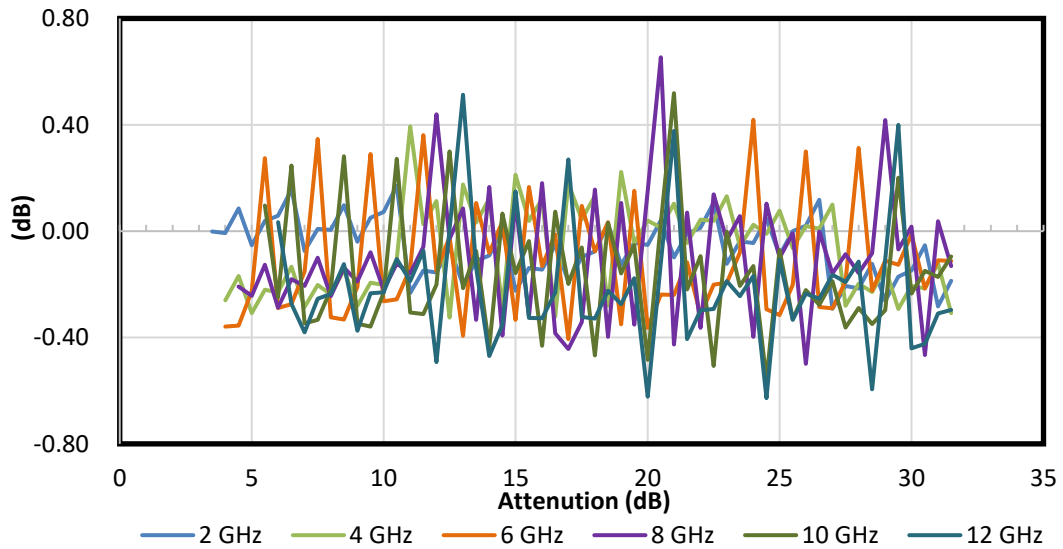

Typical performance S-parameter file: <https://www.amtery.com/en/goods-89>

For each S/N S-parameter file, go to <https://www.amtery.com/en/downloads>

Note: Specifications are subject to change without notice.