

HLMP-CWxx

T-1³/₄ Precision Optical Performance
White LED Lamps



Data Sheet



**HLMP-CW15, HLMP-CW16, HLMP-CW23, HLMP-CW24,
HLMP-CW30, HLMP-CW31, HLMP-CW70, HLMP-CW72**

Description

These high intensity white LED lamps are based on InGaN material technology. A blue LED die is coated by a phosphor to produce white. The typical resulting color is described by the coordinates $x = 0.32$, $y = 0.32$ using the 1931 CIE Chromaticity Diagram.

These T-1³/₄ lamps are untinted, nondiffused, and incorporate precise optics producing well defined spatial radiation patterns at specific viewing cone angle.

Features

- Highly luminous white emission
- 15°, 23°, 30°, and 70° viewing angle

Applications

- Indoor Electronic signs and signals
- Small area illumination
- Legend backlighting
- General purpose indicators

Benefit

- Reduced power consumption, higher reliability, and increased optical/mechanical design flexibility compared to incandescent bulbs and other alternative white light sources

CAUTION: These devices are Class 1C ESD sensitive. Please observe appropriate precautions during handling and processing. Refer to Avago Technologies Application Note AN-1142 for additional details.

Device Selection Guide

Part Number	Viewing Angle Typ.	Min. Luminous Intensity Iv (mcd) @ 20 mA		Standoff Leads	Package Dimension
		Min.	Max.		
HLMP-CW15-TW0xx	15°	2500	7200	No	A
HLMP-CW15-TW0xx	15°	2500	7200	No	A
HLMP-CW15-UV0xx	15°	3200	5500	No	A
HLMP-CW15-VWBxx	15°	4200	7200	No	A
HLMP-CW15-VY0xx	15°	4200	12000	No	A
HLMP-CW15-VYBxx	15°	4200	12000	No	A
HLMP-CW15-VYGxx	15°	4200	12000	No	A
HLMP-CW15-VYKxx	15°	4200	12000	No	A
HLMP-CW16-R00xx	15°	1500	-	Yes	B
HLMP-CW16-TW0xx	15°	2500	7200	Yes	B
HLMP-CW16-VY0xx	15°	4200	12000	Yes	B
HLMP-CW23-SV0xx	23°	1900	5500	No	A
HLMP-CW23-SVKxx	23°	1900	5500	No	A
HLMP-CW23-TW0xx	23°	2500	7200	No	A
HLMP-CW24-SV0xx	23°	1900	5500	Yes	B
HLMP-CW24-TW0xx	23°	2500	7200	Yes	B
HLMP-CW30-PS0xx	30°	880	2500	No	A
HLMP-CW30-RU0xx	30°	1500	4200	No	A
HLMP-CW30-STBxx	30°	1900	3200	No	A
HLMP-CW30-SV0xx	30°	1900	5500	No	A
HLMP-CW31-M00xx	30°	520	-	Yes	B
HLMP-CW31-PS0xx	30°	880	2500	Yes	B
HLMP-CW31-SV0xx	30°	1900	5500	Yes	B
HLMP-CW70-LMBxx	70°	400	680	No	A
HLMP-CW70-LP0xx	70°	400	1150	No	A
HLMP-CW72-LP0xx	70°	400	1150	Yes	B

Notes:

1. Tolerance for each intensity limit is $\pm 15\%$.
2. Please refer to AN 5352 for detail information on features of stand-off and non stand-off LEDs.

Package Dimensions

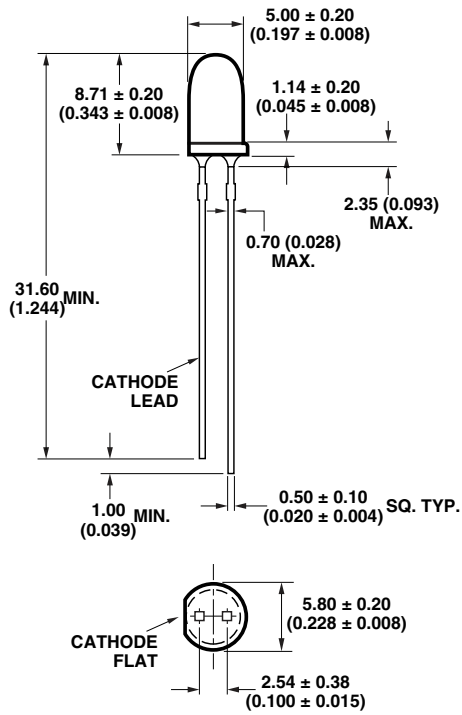

PACKAGE DIMENSION A

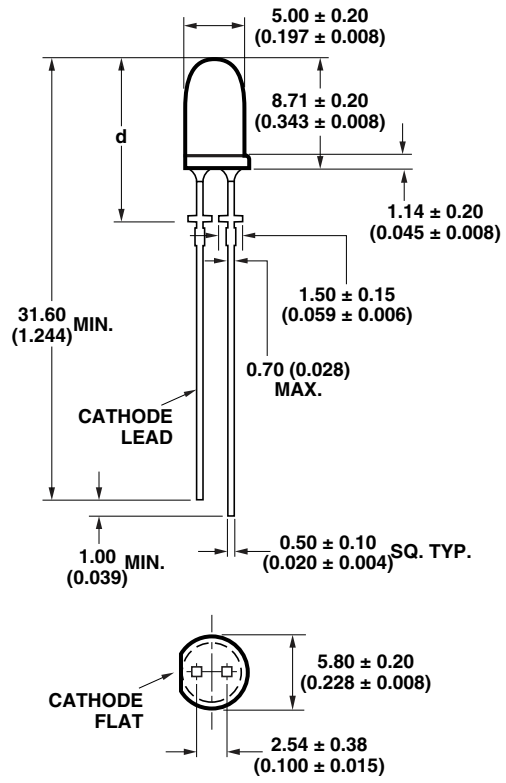

PACKAGE DIMENSION B

NOTES:

1. ALL DIMENSIONS ARE IN MILLIMETERS (INCHES).
2. EPOXY MENISCUS MAY EXTEND ABOUT 1 mm (0.040") DOWN THE LEADS.

HLMP-CW16	HLMP-CW24	HLMP-CW31	HLMP-CW72
d = 12.6 ± 0.25 (0.496 ± 0.010)	d = 12.52 ± 0.25 (0.493 ± 0.010)	d = 11.96 ± 0.25 (0.471 ± 0.010)	d = 12.52 ± 0.25 (0.493 ± 0.010)

Part Numbering System

HLMP - CWxx - x x x xx

Mechanical Option

00: Bulk
DD: Ammo Pack

Color Bin Option

0: Full color bin distribution
B: Color bins 2 & 3
G: Color bins 2, 3 & 4
K: Color bins 2 & 4

Maximum Intensity Bin Limit

0: No maximum intensity bin limit
Others: Refer to Device Selection Guide

Minimum Intensity Bin Limit

Refer to Device Selection Guide

Viewing Angle and Standoff Option

15: 15° without standoffs
16: 15° with standoffs
23: 23° without standoffs
24: 23° with standoffs
30: 30° without standoffs
31: 30° with standoffs
70: 50° without standoffs
72: 50° with standoffs

Note: Please refer to AB 5337 for complete information about part numbering system.

Absolute Maximum Ratings

T_A = 25°C

Parameter	Value	Units
DC Forward Current ^[1]	30	mA
Peak Forward Current ^[2]	100	mA
Power Dissipation	111	mW
Reverse Voltage (I _R = 10 μA)	5	V
LED Junction Temperature	110	°C
Operating Temperature Range	-40 to +80	°C
Storage Temperature Range	-40 to +100	°C

Notes:

1. Derate linearly as shown in Figure 5.
2. Duty factor 10% Frequency 1 kHz.

Electrical Characteristics

T_A = 25°C

Forward Voltage, V _F (V) @ I _F = 20 mA		Reverse Breakdown, V _R (V) @ I _R = 10 μA	Capacitance, C (pF), V _F = 0, f = 1 MHz	Thermal Resistance R _{θJ-PIN} (°C/W)
Typ.	Max.	Min.	Typ.	Typ.
3.2	3.7	5	70	240

Optical Characteristics

T_A = 25°C

Part Number	Typical Chromaticity Coordinates ^[1]		Viewing Angle 2θ _{1/2} Degrees ^[2]
	X	Y	Typ.
HLMP-CW3x-xxxxx	0.32	0.32	30
HLMP-CW2x-xxxxx	0.32	0.32	23
HLMP-CW1x-xxxxx	0.32	0.32	15
HLMP-CW7x-xxxxx	0.32	0.32	50

Notes:

1. The chromaticity coordinates are derived from the CIE 1931 Chromaticity Diagram and represent the perceived color of the device.
2. θ_{1/2} is the off-axis angle where the luminous intensity is 1/2 the peak intensity.

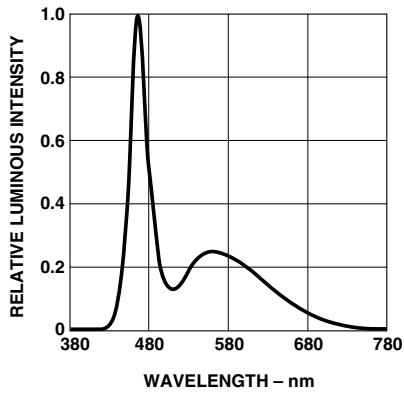

Figure 1. Relative intensity vs. wavelength

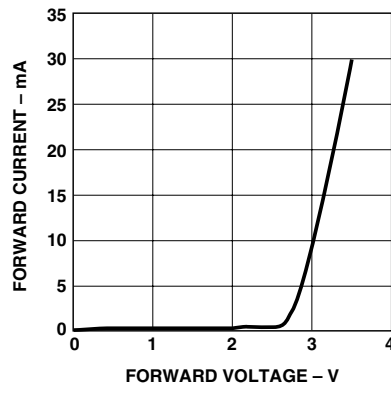

Figure 2. Forward current vs. forward voltage

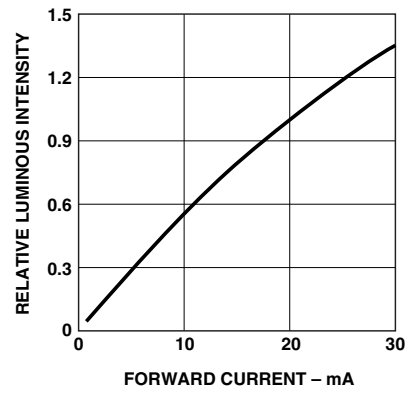

Figure 3. Relative I_v vs. forward current

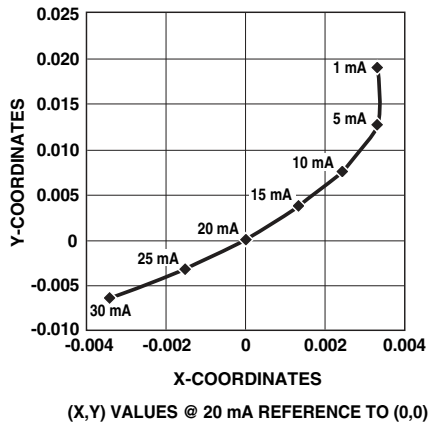

Figure 4. Chromaticity shift vs. current

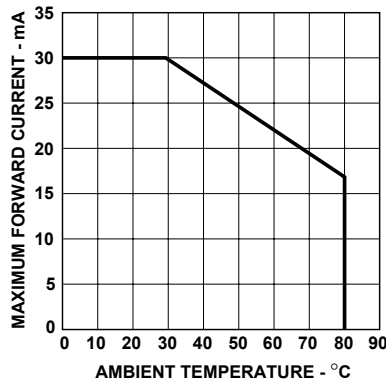

Figure 5. Maximum forward current vs. temperature

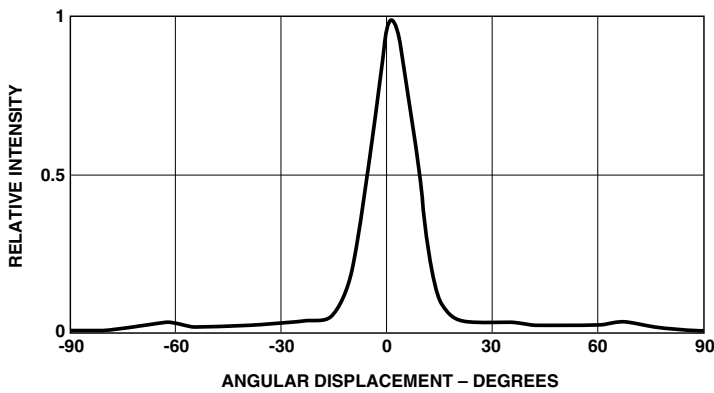

Figure 6a. CW1x spatial radiation pattern

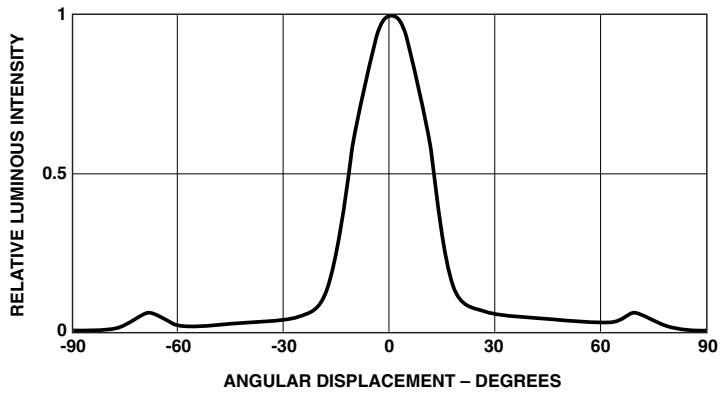

Figure 6b. CW2x spatial radiation pattern

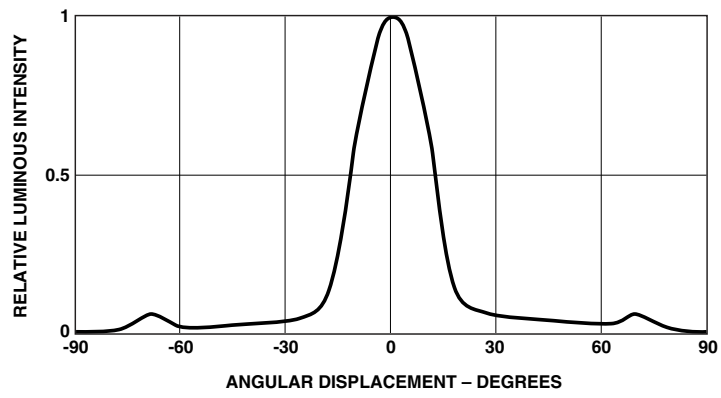

Figure 6c. CW3x spatial radiation pattern

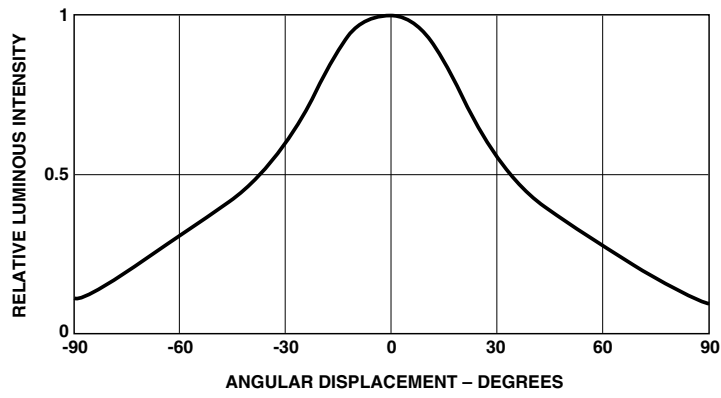

Figure 6c. CW7x spatial radiation pattern

Intensity Bin Limits

(mcd at 20 mA)

Bin	Min.	Max.
L	400	520
M	520	680
N	680	880
P	880	1150
Q	1150	1500
R	1500	1900
S	1900	2500
T	2500	3200
U	3200	4200
V	4200	5500
W	5500	7200
X	7200	9300
Y	9300	12000
Z	12000	16000

Tolerance for each bin limit is $\pm 15\%$.

Color Bin Limit Table

Rank	Limits (Chromaticity Coordinates)				
		x	y		
1	x	0.330	0.330	0.356	0.361
	y	0.360	0.318	0.351	0.385
2	x	0.287	0.296	0.330	0.330
	y	0.295	0.276	0.318	0.339
3	x	0.264	0.280	0.296	0.283
	y	0.267	0.248	0.276	0.305
4	x	0.283	0.287	0.330	0.330
	y	0.305	0.295	0.339	0.360

Tolerance for each bin limit is ± 0.01 .

Note:

Bin categories are established for classification of products. Products may not be available in all bin categories. Please contact your Avago representative for information on currently available bins.

Color Bin Limits with Respect to CIE 1931 Chromaticity Diagram

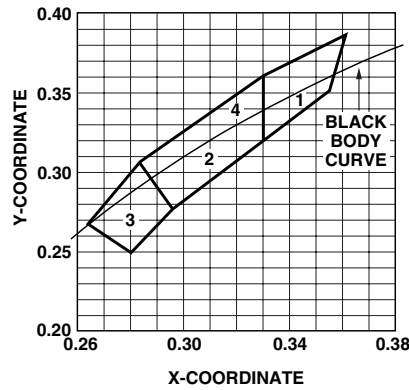

Relative Light Output vs. Junction Temperature

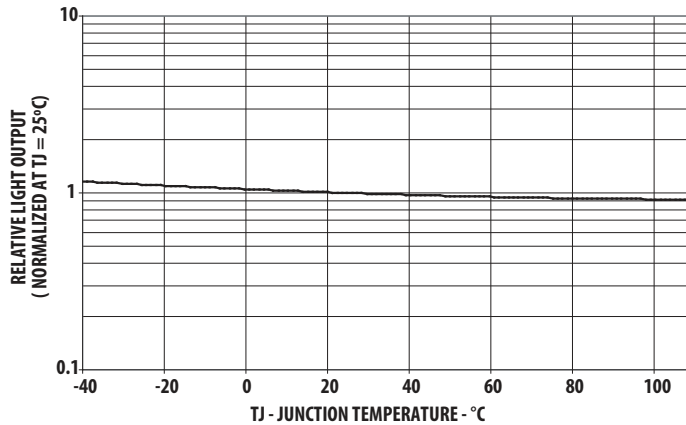

Precautions:

Lead Forming:

- The leads of an LED lamp may be preformed or cut to length prior to insertion and soldering on PC board.
- For better control, it is recommended to use proper tool to precisely form and cut the leads to applicable length rather than doing it manually.
- If manual lead cutting is necessary, cut the leads after the soldering process. The solder connection forms a mechanical ground which prevents mechanical stress due to lead cutting from traveling into LED package. This is highly recommended for hand solder operation, as the excess lead length also acts as small heat sink.

Soldering and Handling:

- Care must be taken during PCB assembly and soldering process to prevent damage to the LED component.
- LED component may be effectively hand soldered to PCB. However, it is only recommended under unavoidable circumstances such as rework. The closest manual soldering distance of the soldering heat source (soldering iron’s tip) to the body is 1.59mm. Soldering the LED using soldering iron tip closer than 1.59mm might damage the LED.

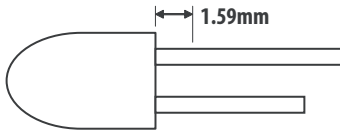

- ESD precaution must be properly applied on the soldering station and personnel to prevent ESD damage to the LED component that is ESD sensitive. Do refer to Avago application note AN 1142 for details. The soldering iron used should have grounded tip to ensure electrostatic charge is properly grounded.
- Recommended soldering condition:

	Wave Soldering [1, 2]	Manual Solder Dipping
Pre-heat temperature	105 °C Max.	-
Preheat time	60 sec Max	-
Peak temperature	250 °C Max.	260 °C Max.
Dwell time	3 sec Max.	5 sec Max

Note:

- 1) Above conditions refers to measurement with thermocouple mounted at the bottom of PCB.
 - 2) It is recommended to use only bottom preheaters in order to reduce thermal stress experienced by LED.
- Wave soldering parameters must be set and maintained according to the recommended temperature and dwell time. Customer is advised to perform daily check on the soldering profile to ensure that it is always conforming to recommended soldering conditions.

Note:

1. PCB with different size and design (component density) will have different heat mass (heat capacity). This might cause a change in temperature experienced by the board if same wave soldering setting is used. So, it is recommended to re-calibrate the soldering profile again before loading a new type of PCB.
2. Avago Technologies’ high brightness LED are using high efficiency LED die with single wire bond as shown below. Customer is advised to take extra precaution during wave soldering to ensure that the maximum wave temperature does not exceed 250°C and the solder contact time does not exceeding 3sec. Over-stressing the LED during soldering process might cause premature failure to the LED due to delamination.

Avago Technologies LED configuration

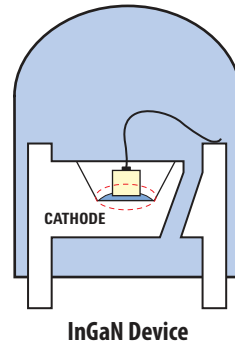

Note: Electrical connection between bottom surface of LED die and the lead frame is achieved through conductive paste.

- Any alignment fixture that is being applied during wave soldering should be loosely fitted and should not apply weight or force on LED. Non metal material is recommended as it will absorb less heat during wave soldering process.
- At elevated temperature, LED is more susceptible to mechanical stress. Therefore, PCB must allowed to cool down to room temperature prior to handling, which includes removal of alignment fixture or pallet.
- If PCB board contains both through hole (TH) LED and other surface mount components, it is recommended that surface mount components be soldered on the top side of the PCB. If surface mount need to be on the bottom side, these components should be soldered using reflow soldering prior to insertion the TH LED.
- Recommended PC board plated through holes (PTH) size for LED component leads.

LED component lead size	Diagonal	Plated through hole diameter
0.45 x 0.45 mm (0.018x 0.018 inch)	0.636 mm (0.025 inch)	0.98 to 1.08 mm (0.039 to 0.043 inch)
0.50 x 0.50 mm (0.020x 0.020 inch)	0.707 mm (0.028 inch)	1.05 to 1.15 mm (0.041 to 0.045 inch)

- Over-sizing the PTH can lead to twisted LED after clinching. On the other hand under sizing the PTH can cause difficulty inserting the TH LED.

Refer to application note AN5334 for more information about soldering and handling of high brightness TH LED lamps.

Example of Wave Soldering Temperature Profile for TH LED

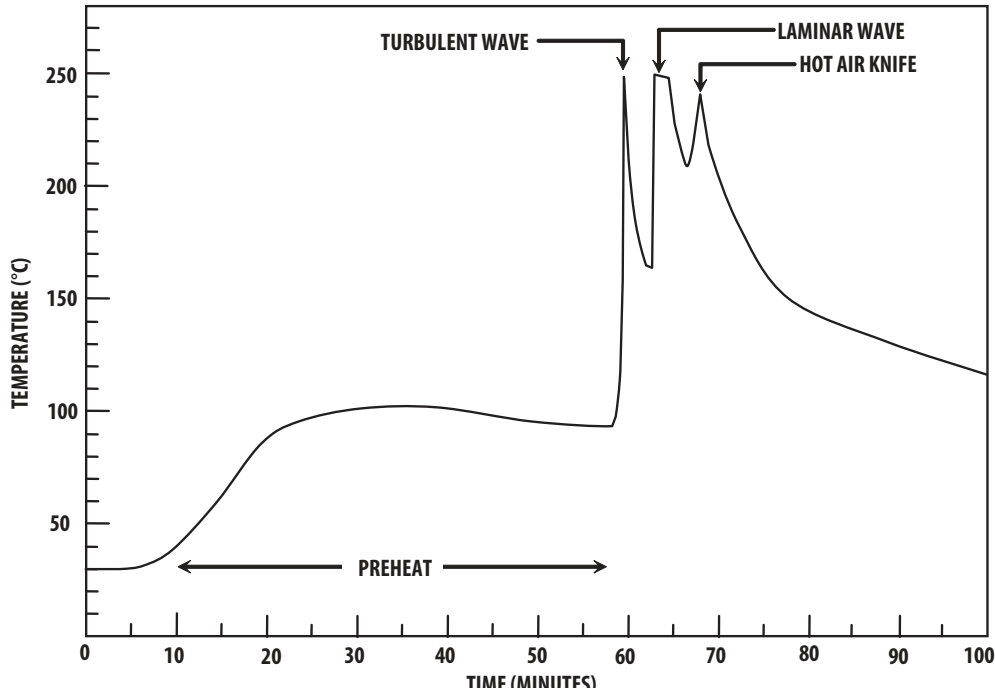

Recommended solder:
Sn63 (Leaded solder alloy)
SAC305 (Lead free solder alloy)

Flux: Rosin flux

Solder bath temperature:
245°C ± 5°C (maximum peak temperature = 250°C)

Dwell time: 1.5 sec - 3.0 sec (maximum = 3sec)

Note: Allow for board to be sufficiently cooled to room temperature before exerting mechanical force.

Ammo Packs Drawing

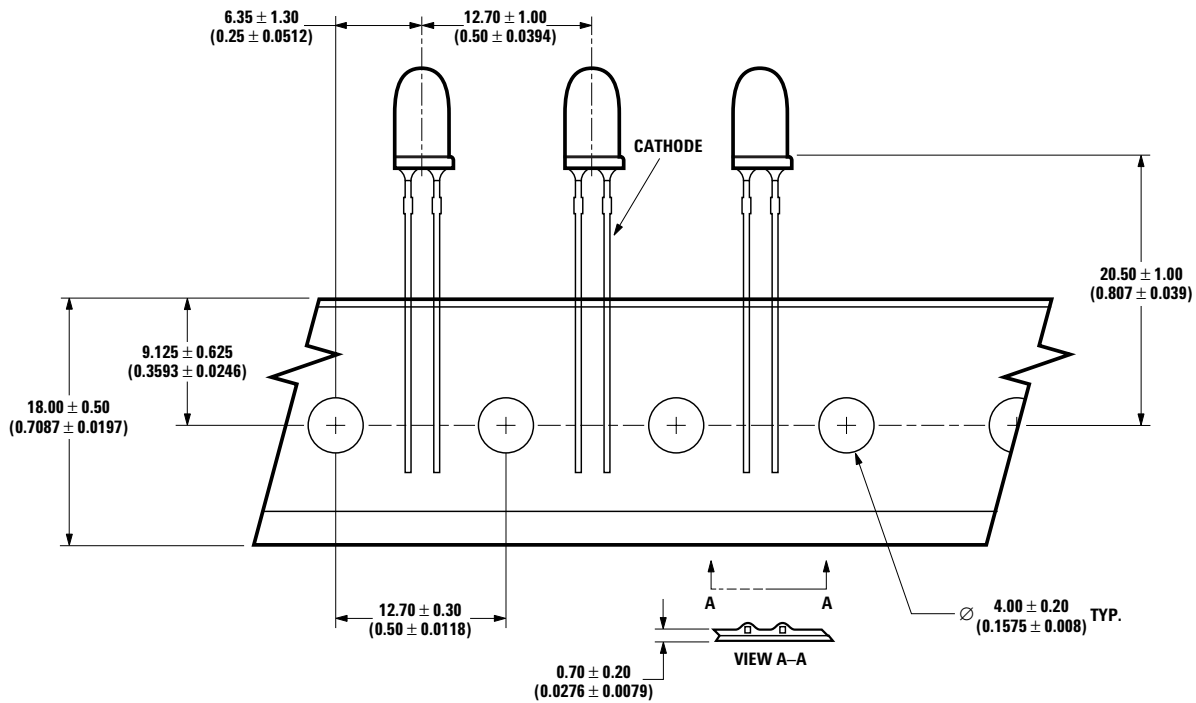

ALL DIMENSIONS IN MILLIMETERS (INCHES).

Note: The ammopacks drawing is applicable to option -DD & -ZZ and regardless of standoff or non standoff.



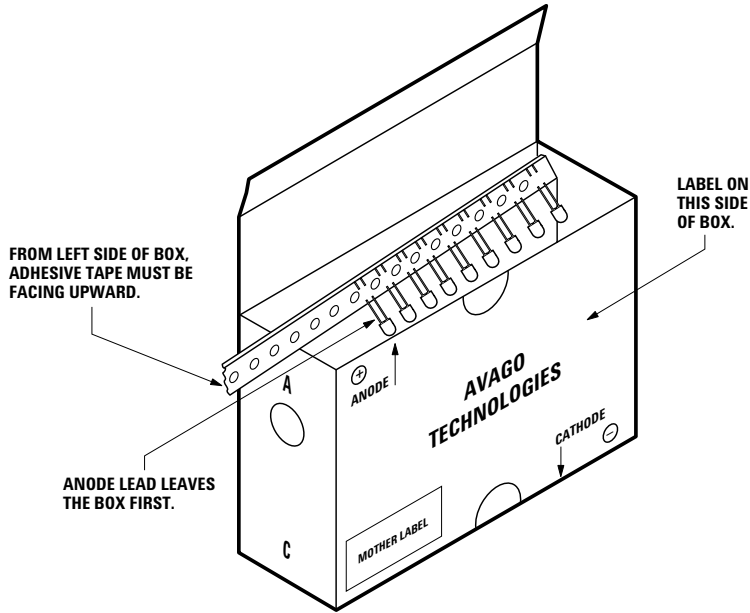







Packaging Box Ammo Packs



Note: For InGaN device, the ammo pack packaging box contains ESD logo.

Packaging Label

(i) Avago Mother Label: (Available on packaging box of ammo pack and shipping box)

Avago TECHNOLOGIES	
(1P) Item: Part Number	STANDARD LABEL LS0002
	RoHS Compliant
(1T) Lot: Lot Number	e1 max temp 250C
	(Q) QTY: Quantity
LPN	
	CAT: Intensity Bin
(9D) MFG Date: Manufacturing Date	
	BIN: Refer to below information
(P) Customer Item:	REV:
	
(V) Vendor ID	DeptID:
	
Made In: Country of Origin	

(ii) Avago Baby Label (Only available on bulk packaging)

AVAGO TECHNOLOGIES		RoHS Compliant e1 max temp 250C
PART #: Part Number		
LOT#: Lot Number		
MFG DATE: Manufacturing Date		QUANTITY: Packing Quantity
C/O: Country of Origin		
Customer P/N:		CAT: Intensity Bin
Supplier Code:		
		BIN: Refer to below information
		DATECODE: Date Code

Acronyms and Definition:

BIN:

- (i) Color bin only or VF bin only
(Applicable for part number with color bins but without VF bin OR part number with VF bins and no color bin)
OR
- (ii) Color bin incorporated with VF Bin
(Applicable for part number that have both color bin and VF bin)

Example:

- (i) Color bin only or VF bin only
BIN: 2 (represent color bin 2 only)
BIN: VB (represent VF bin "VB" only)
- (ii) Color bin incorporate with VF Bin
BIN: 2VB

DISCLAIMER: AVAGO'S PRODUCTS AND SOFTWARE ARE NOT SPECIFICALLY DESIGNED, MANUFACTURED OR AUTHORIZED FOR SALE AS PARTS, COMPONENTS OR ASSEMBLIES FOR THE PLANNING, CONSTRUCTION, MAINTENANCE OR DIRECT OPERATION OF A NUCLEAR FACILITY OR FOR USE IN MEDICAL DEVICES OR APPLICATIONS. CUSTOMER IS SOLELY RESPONSIBLE, AND WAIVES ALL RIGHTS TO MAKE CLAIMS AGAINST AVAGO OR ITS SUPPLIERS, FOR ALL LOSS, DAMAGE, EXPENSE OR LIABILITY IN CONNECTION WITH SUCH USE.

For product information and a complete list of distributors, please go to our website: www.avagotech.com

Avago, Avago Technologies, and the A logo are trademarks of Avago Technologies Limited in the United States and other countries.
Data subject to change. Copyright © 2005-2008 Avago Technologies Limited. All rights reserved. Obsoletes 5989-4125EN
AV02-0214EN - April 4, 2008

