

16x8 MATRIX LED DRIVER

DESCRIPTION

The IS31FL3729 is a general purpose 16x8 or 15x9 LED Matrix programmed via 1MHz I2C compatible interface. Each LED can be dimmed individually with 8-bit PWM data, and each CSx has 8-bit DC scaling (Color Calibration) data which allowing 256 steps of linear PWM dimming for each dot and 256 steps of DC current adjustable level for each CSx.

Additionally each LED open and short state can be detected, IS31FL3729 store the open or short information in Open-Short Registers. The Open-Short Registers allowing MCU to read out via I2C compatible interface. Inform MCU whether there are LEDs open or short and the locations of open or short LEDs.

FEATURES

- Supply voltage range: 2.7V to 5.5V
- 16 current sinks
- Support 16xn(n=1~8), 15x9 LED matrix configurations
- Individual 256 PWM control steps
- 256 DC current steps for each CSx
- 64 global current steps
- SDB rising edge reset I2C module
- 29kHz PWM frequency
- 1MHz I2C-compatible interface
- Individual open and short error detect function
- PWM 180 degree phase shift
- Spread Spectrum
- De-Ghost
- QFN-32 (4mmx4mm) package

QUICK START



Figure 1: Photo of IS31FL3729 Evaluation Board

RECOMMENDED EQUIPMENT

- 5.0V, 2A power supply

ABSOLUTE MAXIMUM RATINGS

- ≤ 5.5V power supply

Caution: Do not exceed the conditions listed above, otherwise the board will be damaged.

PROCEDURE

The IS31FL3729 evaluation board is fully assembled and tested. Follow the steps listed below to verify board operation.

Caution: Do not turn on the power supply until all connections are completed.

- 1) Short JP1.
- 2) Connect the 5V DC power to VCC (JP3) / GND (JP2), or plug in the USB power input to micro-USB (CON1).
- 3) Turn on the power supply/Plug in the Micro USB Pay attention to the supply current. If the current exceeds 1A, please check for circuit fault.

EVALUATION BOARD OPERATION

The IS31FL3729 evaluation board has three animation display modes. Toggling the MODE button (S1) can switch the modes.

- 1) Rainbow wave#1
- 2) Rainbow wave#2
- 3) Raining mode
- 4) Swing mode

Note: IS31FL3729 solely controls the FxLED function on the evaluation board.

ORDERING INFORMATION

Part No.	Temperature Range	Package
IS31FL3729-QFLS4-EB	-40°C to +125°C (Industrial)	QFN-32, Lead-free

Table 1: Ordering Information

For pricing, delivery, and ordering information, please contacts Lumissil's analog marketing team at analog@Lumissil.com or (408) 969-6600.

16×8 MATRIX LED DRIVER

SOFTWARE SUPPORT

JP1 default setting is closed (jumper on). If it is open (no jumper), the on-board MCU will configure its own I2C/SDB/AD pins to High Impedance status so an external source can driver the I2C/SDB signals to control the IS31FL3729 LED driver.

The AD pin is pulled low via R5 setting the device address of IS31FL3729 to 0x68.

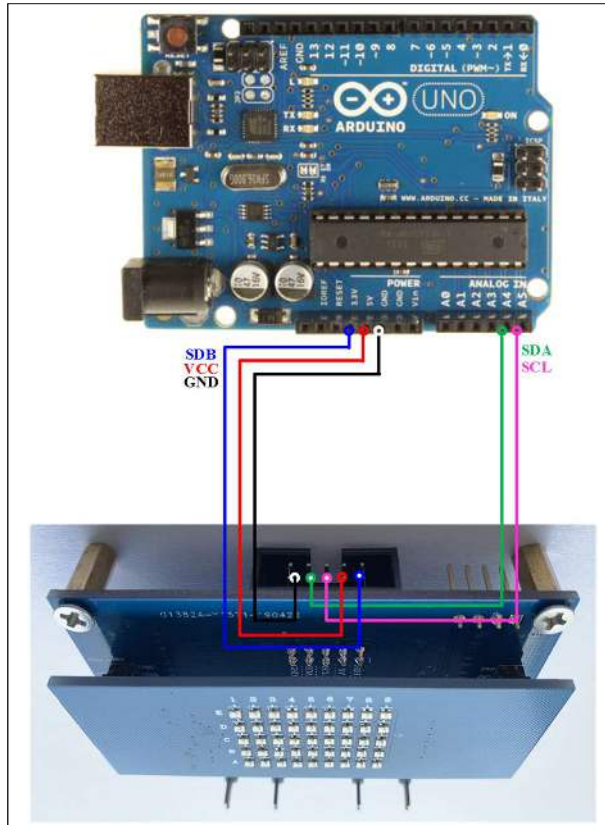

Figure 2: Photo of Arduino UNO connected to Evaluation Board

The steps listed below is an example of using the Arduino for external control.

The Arduino hardware consists of an Atmel microcontroller with a bootloader allowing quick firmware updates. First download the latest Arduino Integrated Development Environment IDE (1.6.12 or greater) from www.arduino.cc/en/Main/Software. Also download the Wire.h library from www.arduino.cc/en/reference/wire and verify that pgmspace.h is in the directory ...program Files(x86)/Arduino/hardware/tools/avr/avr/include/avr/. Then download the latest IS31FL3729 test firmware (sketch) from the Lumissil website <http://www.lumissil.com/products/led-driver/fxled>.

- 1) Open JP1.
- 2) Connect the 5 pins from Arduino board to IS31FL3729 EVB:
 - a) Arduino 5V pin to IS31FL3729 EVB PVCC.
 - b) Arduino GND to IS31FL3729 EVB GND.
 - c) Arduino SDA (A4) to IS31FL3729 EVB P1.
 - d) Arduino SCL (A5) to IS31FL3729 EVB P3.
 - e) If Arduino use 3.3V MCU VCC, connect 3.3V to IS31FL3729 EVB SDB, if Arduino use 5.0V MCU VCC, connect 5.0V to EVB SDB. (Arduino UNO MCU VCC is 5V, so SDB can be 5V or 3.3V)
- 3) Use the test code in appendix I or download the test firmware (sketch) from the Lumissil website, a .txt file and copy the code to Arduino IDE, compile and upload to Arduino.
- 4) Run the Arduino code as appendix I.
- 5) In EVB code, the AD pin is pulled low via 10k, so the device address is 0x68. When JP1 is open, the AD pin can be changed by connecting the AD as follows:
 - a) AD=VCC, device address=0x6E.
 - b) AD=SCL, device address=0x6A.
 - c) AD=SDA, device address=0x6C.

Please refer to the datasheet to get more information about IS31FL3729.

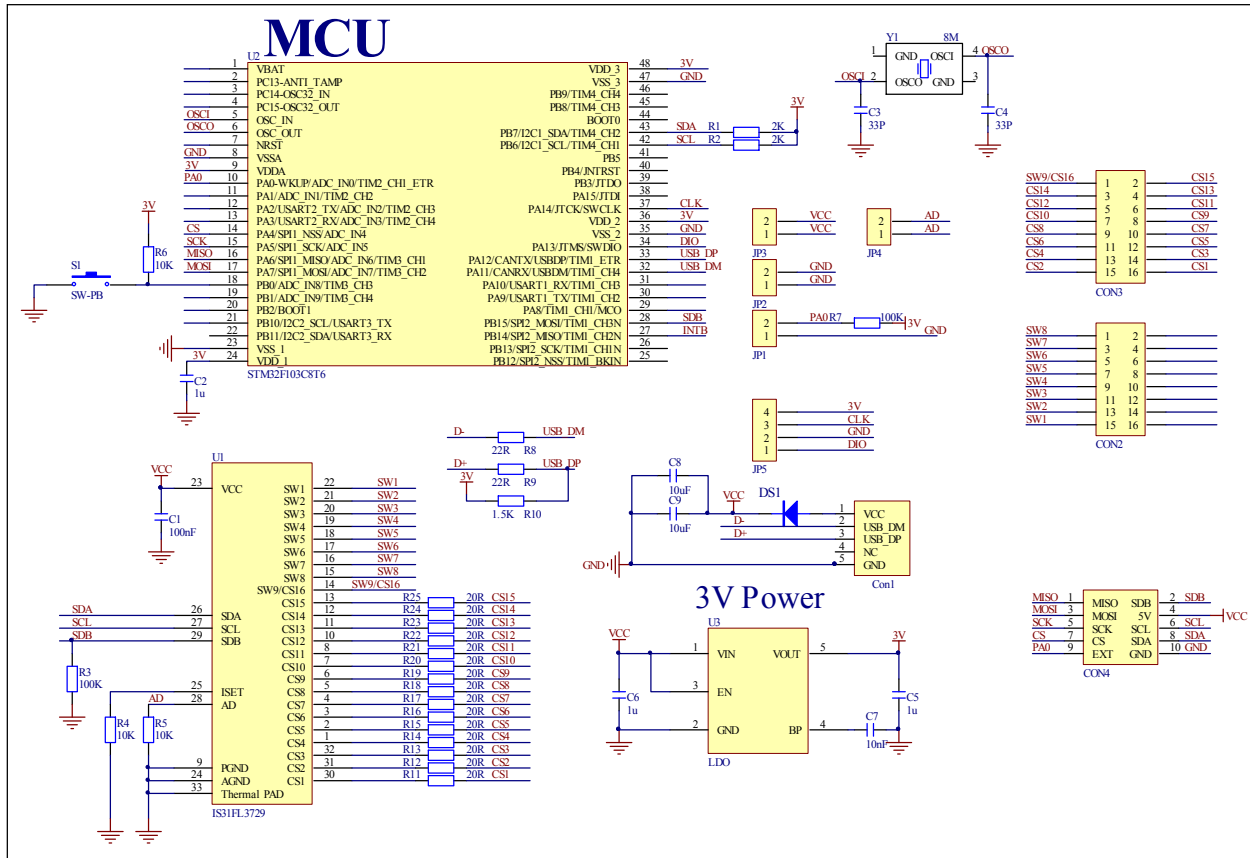

Figure 3: IS31FL3729 Application Schematic

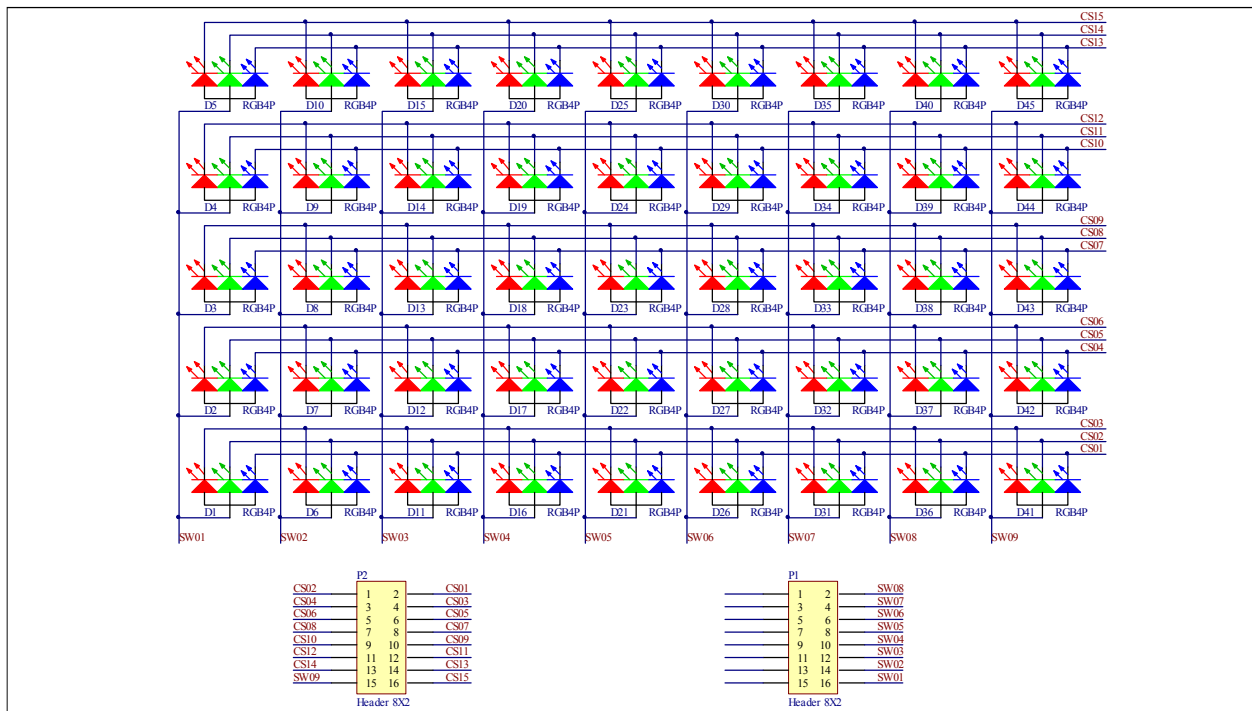

Figure 4: FxLED 9x5 ARRAY Application Schematic

16x8 MATRIX LED DRIVER

BILL OF MATERIALS

IS31FL3729

Name	Symbol	Description	Qty	Supplier	Part No.
LED Driver	U1	Matrix LED Driver	1	Lumissil	IS31FL3729
MCU	U2	Microcontroller	1	STM	STM32F103C8T6
LDO	U3	Reduced voltage	1	SGMICRO	SGM2019-3.3V
Crystal	Y1	Crystal, 8MHz	1	JB	HC-49S
Diode	DS1	Diode, SMD	1	DIODES	DFLS240
Resistor	R1,R2	RES,2k,1/16W,±5%,SMD	2	Yageo	RC0603JR-072KL
Resistor	R3,R4,R7	RES,100K,1/16W,±5%,SMD	3	Yageo	RC0603JR-07100KL
Resistor	R4,R5,R6	RES,10k,1/16W,±5%,SMD	3	Yageo	RC0603JR-0710KL
Resistor	R8,R9	RES,22R,1/16W,±5%,SMD	2	Yageo	RC0603JR-0722RL
Resistor	R10	RES,1.5k,1/16W,±5%,SMD	1	Yageo	RC0603JR-071K5L
Resistor	R11,R12, R14,R15, R17,R18, R20,R21, R23,R24	RES,20R,1/10W,±5%,SMD	10	Yageo	RC0603JR-0720RL
Resistor	R13,R16, R19,R22, R25	RES,20R,1/10W,±5%,SMD (Note 1)	5	Yageo	RC0603JR-0720RL
Capacitor	C1	CAP,0.1µF,16V,±20%,SMD	1	Yageo	CC0603MRX7R7BB104
Capacitor	C2,C5,C6	CAP,1µF,16V,±20%,SMD	3	Yageo	CC0603KRX7R7BB105
Capacitor	C3,C4	CAP,33pF,16V,±20%,SMD	2	Yageo	CQ0603JRNPO9BN330
Capacitor	C7	CAP,10nF,16V,±20%,SMD	1	Yageo	CC0603KRX7R7BB103
Capacitor	C8,C9	CAP,10uF,16V, ±20%,SMD	2	Yageo	CC0805MKX5R7BB106
Button	S1	Button SMD	1		

Bill of Materials, refer to Figure 3 above.

FxLED 9x15 ARRAY

Name	Symbol	Description	Qty	Supplier	Part No.
LED	D1~D45	RGB LED, SMD	45	Everlight	9-237/R6GHBHC-A01/2T

Bill of Materials, refer to Figure 4 above.

Note 1: The value of these resistors on the evaluation board is 20Ω. For PVCC=5V and red LED application, prefer 51Ω for these resistors as shown in datasheet Figure 1.

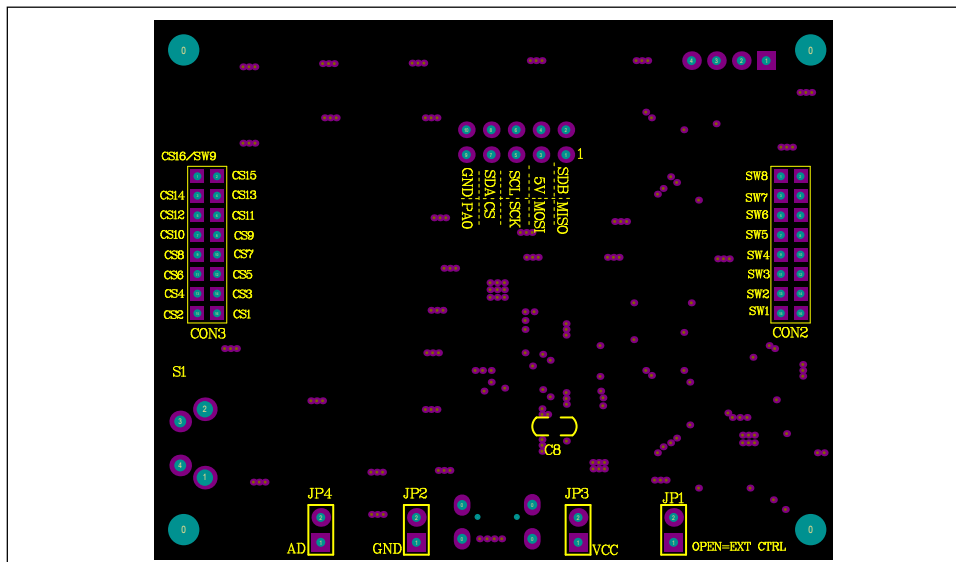

Figure 5: Board Component Placement Guide - Top Layer

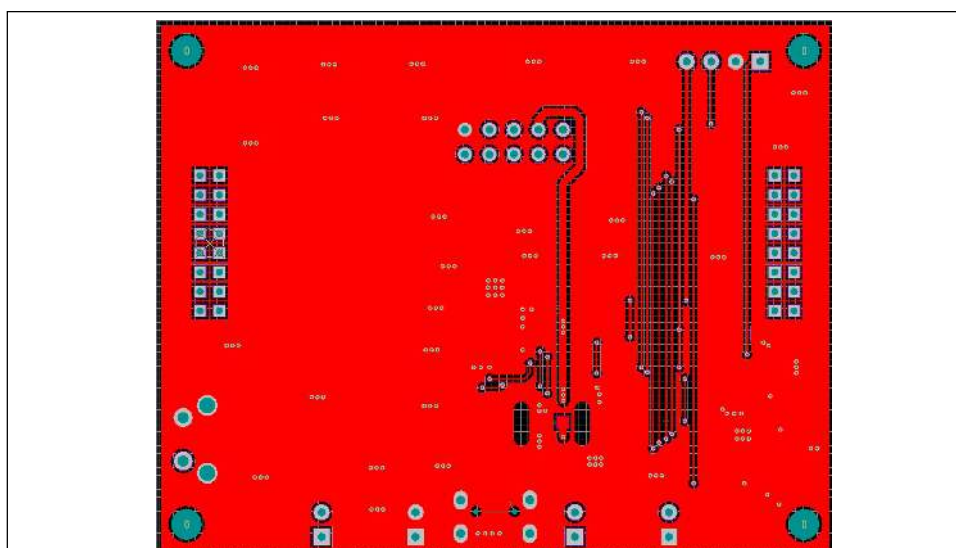

Figure 6: Board PCB Layout - Top Layer

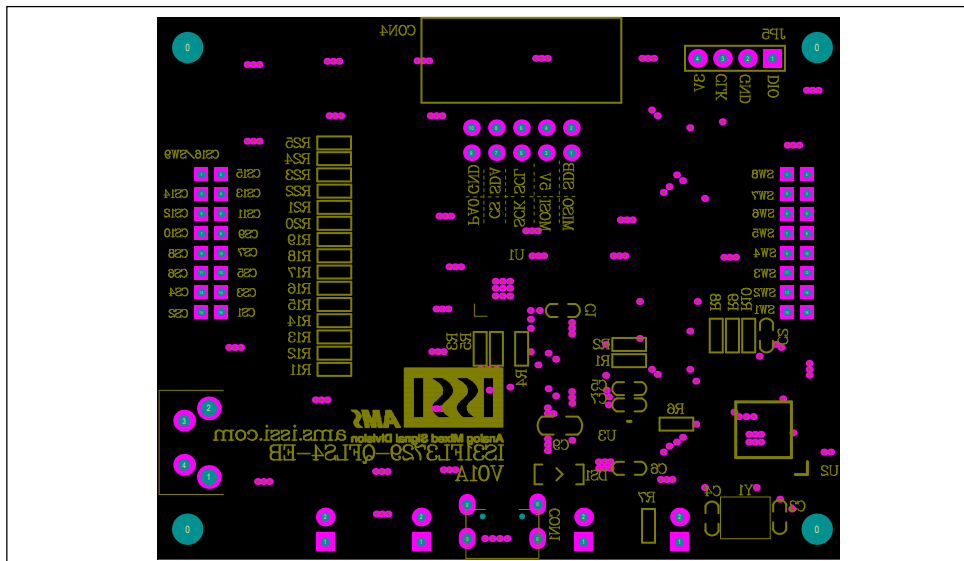

Figure 7: Board Component Placement Guide - Bottom Layer

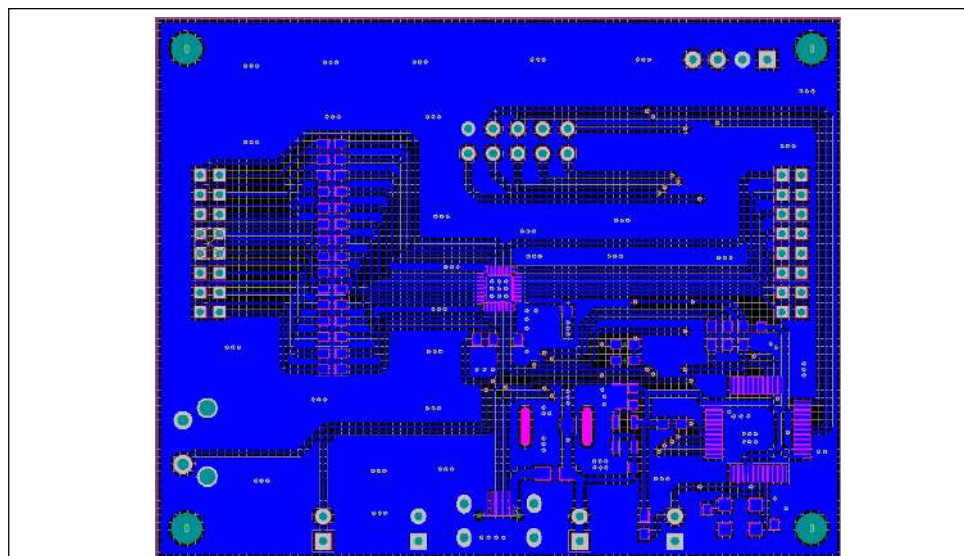

Figure 8: Board PCB Layout - Bottom Layer

16x8 MATRIX LED DRIVER

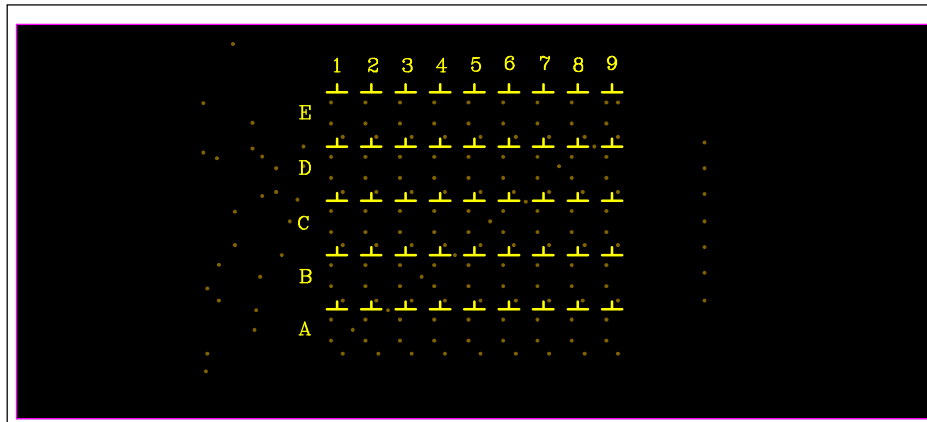

Figure 9: LED Board Component Placement Guide - Top Layer

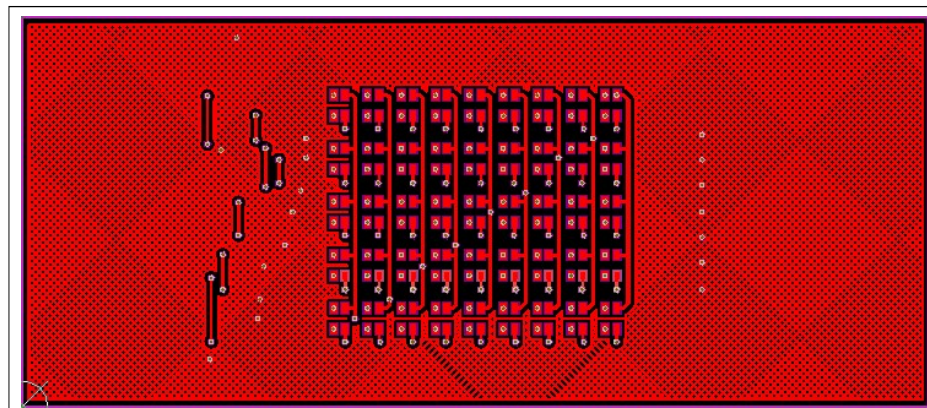

Figure 10: LED Board PCB Layout - Top Layer

16x8 MATRIX LED DRIVER

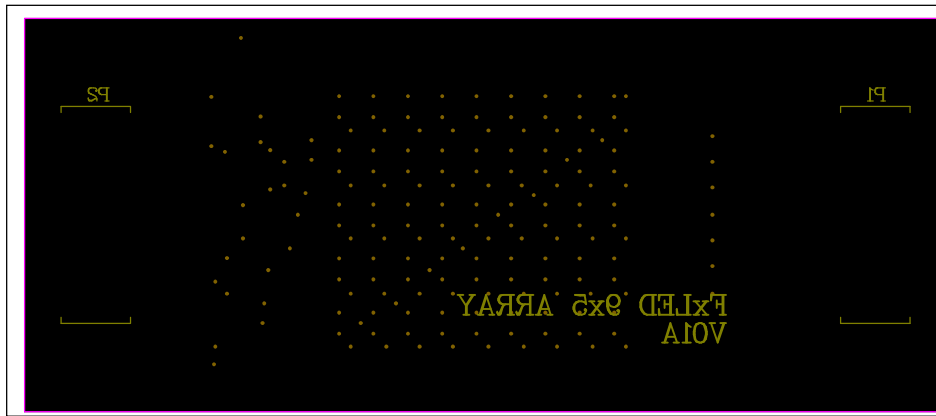

Figure 11: LED Board Component Placement Guide - Bottom Layer

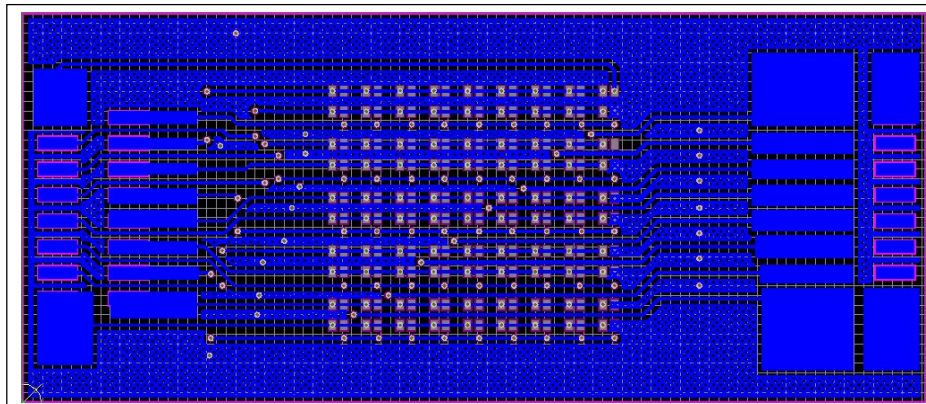

Figure 12: LED Board PCB Layout - Bottom Layer

Copyright © 2021 Lumissil Microsystems. All rights reserved. Lumissil Microsystems reserves the right to make changes to this specification and its products at any time without notice. Lumissil Microsystems assumes no liability arising out of the application or use of any information, products or services described herein. Customers are advised to obtain the latest version of this device specification before relying on any published information and before placing orders for products.

Lumissil Microsystems does not recommend the use of any of its products in life support applications where the failure or malfunction of the product can reasonably be expected to cause failure of the life support system or to significantly affect its safety or effectiveness. Products are not authorized for use in such applications unless Lumissil Microsystems receives written assurance to its satisfaction, that:

- a.) the risk of injury or damage has been minimized;
- b.) the user assume all such risks; and
- c.) potential liability of Lumissil Microsystems is adequately protected under the circumstances

16x8 MATRIX LED DRIVER

REVISION HISTORY

Revision	Detail Information	Date
A	Initial release	2019.05.15
B	Fix silk screen labels for figures 6, 8, 10, 12	2019.08.26
C	Update the Arduino Code	2021.08.31

16×8 MATRIX LED DRIVER

APPENDIX I : IS31FL3729 Arduino Test Code V01B

```

#include<Wire.h>
#include<avr/pgmspace.h>

#define AD_GND 0x68
#define R 0x80
#define G 0x80
#define B 0x80
uint8_t i,j;

const PROGMEM byte PWM_Gama64[64]=
{
  0x00,0x01,0x02,0x03,0x04,0x05,0x06,0x07,
  0x08,0x09,0x0b,0x0d,0x0f,0x11,0x13,0x16,
  0x1a,0x1c,0x1d,0x1f,0x22,0x25,0x28,0x2e,
  0x34,0x38,0x3c,0x40,0x44,0x48,0x4b,0x4f,
  0x55,0x5a,0x5f,0x64,0x69,0x6d,0x72,0x77,
  0x7d,0x80,0x88,0x8d,0x94,0x9a,0xa0,0xa7,
  0xac,0xb0,0xb9,0xbf,0xc6,0xcb,0xcf,0xd6,
  0xe1,0xe9,0xed,0xf1,0xf6,0xfa,0xfe,0xff
};

void setup() {
  Wire.begin();
  Wire.setClock(400000);//I2C 400KHz
  Init_3729(R, G, B);
}

void loop() {
  IS31FL3729_Test_mode1();//breath mode
}

void IS_IIC_WriteByte(uint8_t Dev_Add,uint8_t Reg_Add,uint8_t Reg_Dat)
{
  Wire.beginTransmission(Dev_Add/2); // transmit to device IS31FL373x
  Wire.write(Reg_Add); // sends regaddress
  Wire.write(Reg_Dat); // sends regaddress
  Wire.endTransmission(); // stop transmitting
}

void Init_3729(uint8_t Rdata, uint8_t Gdata, uint8_t Bdata)
{
  // IS_IIC_WriteByte(AD_GND,0xfe,0xc5);//unlock
  // IS_IIC_WriteByte(AD_GND,0xfd,0x02);//write page 2
  for(i=92;i<0x9f;i+=3)

```

16x8 MATRIX LED DRIVER

```

{
    IS_IIC_WriteByte(AD_GND,i,Rdata);//R LED Scaling
}
for(i=91;i<0x9f;i+=3)
{
    IS_IIC_WriteByte(AD_GND,i,Gdata);//G LED Scaling
}
for(i=90;i<0x9f;i+=3)
{
    IS_IIC_WriteByte(AD_GND,i,Bdata);//B LED Scaling
}

// IS_IIC_WriteByte(AD_GND,0xfe,0xc5);//unlock
// IS_IIC_WriteByte(AD_GND,0xfd,0x00);//write page 0
for(i=0x01;i<0x8f;i++)
{
    IS_IIC_WriteByte(AD_GND,i,0x00);//write all PWM set 0x00
}

IS_IIC_WriteByte(AD_GND,0xA1,0x7F);//global current
IS_IIC_WriteByte(AD_GND,0xA0,0x01);//normal operation
}

void IS31FL3729_Test_mode1(void)//
{
    for (j=0;j<64;j++)//all LED ramping up
    {
        for(i=01;i<=0x8F;i++)
        {
            IS_IIC_WriteByte(AD_GND,i,pgm_read_byte_near(&PWM_Gama64[j]));//set all PWM
        }
        delay(10);//10ms
    }
    delay(1000); //keep on 1s

    for (j=63;j>0;j--)//all LED ramping down
    {
        for(i=0x01;i<=0x8F;i++)
        {
            IS_IIC_WriteByte(AD_GND,i,pgm_read_byte_near(&PWM_Gama64[j-1]));//set all PWM
        }
        delay(10);//10ms
    }
    delay(500); //keep off 0.5s
}

```