

FAN4855

500mA High Efficiency Boost Regulator with Adjustable Output, Shutdown and Low Battery Detect

Features

- Low power PFM boost regulator
- Input voltage range is from 1.6V to 4.5V
- Output voltage range is from 3V to 5V
- 500mA maximum load current capability
- 95% efficient power conversion
- 2-3 cell and single cell Li-Ion systems
- Variable on-time Pulse Frequency Modulation (PFM)
- Internal synchronous rectifier (no need for external diode)
- Low-battery detection
- Logic controlled shutdown with true-load disconnect
- Low (80 μ A) quiescent current
- TSSOP-8 Package

Applications

- DSCs
- PDAs
- Cell phones, smart phones
- Portable instrumentations
- 2-3 AA / AAA cells operated devices
- Single cell Li-Ion operated devices

General Description

The FAN4855 is a low power boost regulator designed for low voltage DC to DC conversion in 2-cell battery powered systems such as digital cameras, cell phones and PDAs. The converter starts-up at 1.3V and operates after the start at an input voltage as low as 1V. Output voltage can be adjusted by external resistors from 3.3V to 5V with a maximum load current of 0.5A. Quiescent current in shut-down mode is less than 10 μ A, which maximizes the battery live time. The ON time changes with the input voltage to maintain the ripple current constant and to provide the highest efficiency over a wide load range—while maintaining low peak currents in the boost inductor. The combination of built-in power transistors, synchronous rectification and low supply current, make the FAN4855 ideal for portable applications. The FAN4855 is available in 8-lead TSSOP package.

Ordering Information ($T_A = -40^{\circ}\text{C}$ to $+85^{\circ}\text{C}$)

Part Number	Package	Packing
FAN4855MTC	8 Pin TSSOP	Rails
FAN4855MTCX	8 Pin TSSOP	Tape and Reel

Typical Application

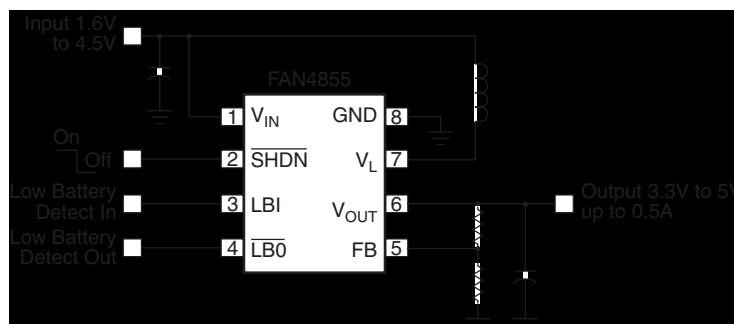

Pin Configuration

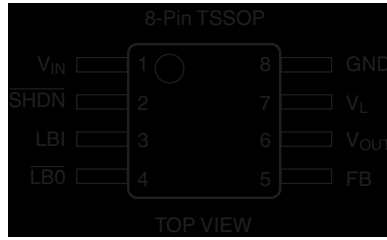

Pin Description

Pin	Name	Function
1	V_{IN}	Battery Input Voltage. Supplies the IC during start-up. After the output is running, the IC draws power from V_{OUT} .
2	\overline{SHDN}	Shut Down. Pulling this pin low shuts down the regulator, isolating the load from the input.
3	LBI	Low-Battery Input. Pulling this pin below 0.39V causes the LBO pin to go low.
4	\overline{LBO}	Low-Battery Output. This pin provides an active low signal to alert the user when the LBI voltage falls below its targeted value. The open-drain output can be used to reset a microcontroller.
5	FB	Feedback Input. For setting the output voltage. Connect this pin to the resistor divider.
6	V_{OUT}	Boost regulator output. Output voltage can be set to be in the 3 to 5V range. Startup at moderate load is achievable at input voltages around 1.35V.
7	V_L	Boost inductor connection. Connect an inductor between this pin and V_{IN} . When servicing the output supply, this pin pulls low, charging the inductor, then shuts off dumping the energy through the synchronous rectifier to the output.
8	GND	Ground of the IC.

Absolute Maximum Ratings

Absolute Maximum Ratings are those values, beyond which the device could be permanently damaged. Absolute maximum ratings are stress ratings only and functional device operation is not implied.

Parameter	Min.	Max.	Units
V_{IN} , V_{OUT} Voltages (Relative to GND)	-0.3	6.5	V
Switch Voltage (V_L to GND)	-0.3	$V_{OUT} + 0.3$	V
Voltage on any other Pin	-0.3	$V_{OUT} + 0.3$	V
Peak Switch Current (I_{peak})	— Internally Limited —		
Output Current (I_{OUT})		500	mA
Continuous Power Dissipation		525	mW
Thermal Resistance (θ_{JA})		124	°C/W
Junction Temperature		150	°C
Storage Temperature Range	-65	150	°C
Lead Temperature (soldering, 10s)		300	°C

Recommended Operating Conditions

Parameter	Min.	Max.	Units
Ambient Temperature Range	-40	+85	°C
V _{IN} Operating Range	1.6	0.9 V _{OUT}	V
V _{OUT} Operating Range	3.0	5.0	V

Electrical Characteristics

Unless otherwise specified, V_{IN} = 1.6V to 3V, I_{LOAD} = 1mA, T_A = -40°C to +85°C. Test Circuit Fig.1. Typical values are at T_A = +25°C

Parameter	Conditions	Min.	Typ.	Max.	Units
Start Up Voltage	I _{LOAD} < 1mA		1.35	1.6	V
Operating Voltage	After start I _{LOAD} = 10mA, V _{OUT} = 3.3V or 5V		1.0		V
Output Voltage	V _{OUT} (nom.) = 3.3V (Note 1)	3.15	3.3	3.45	V
	V _{OUT} (nom.) = 5V	4.775	5	5.225	V
Output Voltage Adjust Range		3		5	V
Steady State Output Current	V _{OUT} = 3.3V, V _{IN} = 2.5V	300	500		mA
	V _{OUT} = 5V, V _{IN} = 2.5V	200	330		mA
Pulse Width	V _{IN} = 3V	0.8	1.4	2	μs
	V _{IN} = 2.4V	1.2	1.7	2.5	μs
	V _{IN} = 1.8V	1.6	2.2	3.3	μs
	V _{IN} = 1.6V	1.7	2.5	4.0	μs
Minimum Off-Time			1		μs
Line Regulation	I _{OUT} = 2mA, V _{OUT} = 3.3V		0.5	2	%
	V _{OUT} = 5V		0.5	2	%
Load Regulation	0 to 250mA, V _{IN} = 2.4V, V _{OUT} = 3.3V		0.5		%
	0 to 150mA, V _{IN} = 2.4V, V _{OUT} = 5V		1		%
Feedback Voltage (VFB)			1.243		V
LBI Threshold Voltage			0.390		V
LBI Hysteresys			25		mV
Internal NFET, PFET ON Resist.	I _{LOAD} = 100mA		0.35		Ω
Power Efficiency	I _{LOAD} = 200mA, V _{IN} = 3V, V _{OUT} = 3.3V		95		%
Input Current in Shut Down Mode	SHDN = 0V, V _{IN} = 3V (Note 2)		8	50	μA
Quiescent Current	SHDN = 3V, V _{IN} = 3V, V _{OUT} = 3.3V (Note 2)		80	160	μA
LBO Output Voltage Low	V _{LBI} = 0, I _{SINK} = 1mA		0.2		V
SHDN Input Threshold Voltage	V _{IN} = 3V, V _{OUT} = 3.3V/5V		1.5		V
SHDN Input Threshold Voltage	V _{IN} = 1.6V, V _{OUT} = 3.3V/5V		0.8		V

Notes:

1. R4, R5, R6 tolerance ≤ 0.1%.
2. Current through R1, R2 is not taken into account.

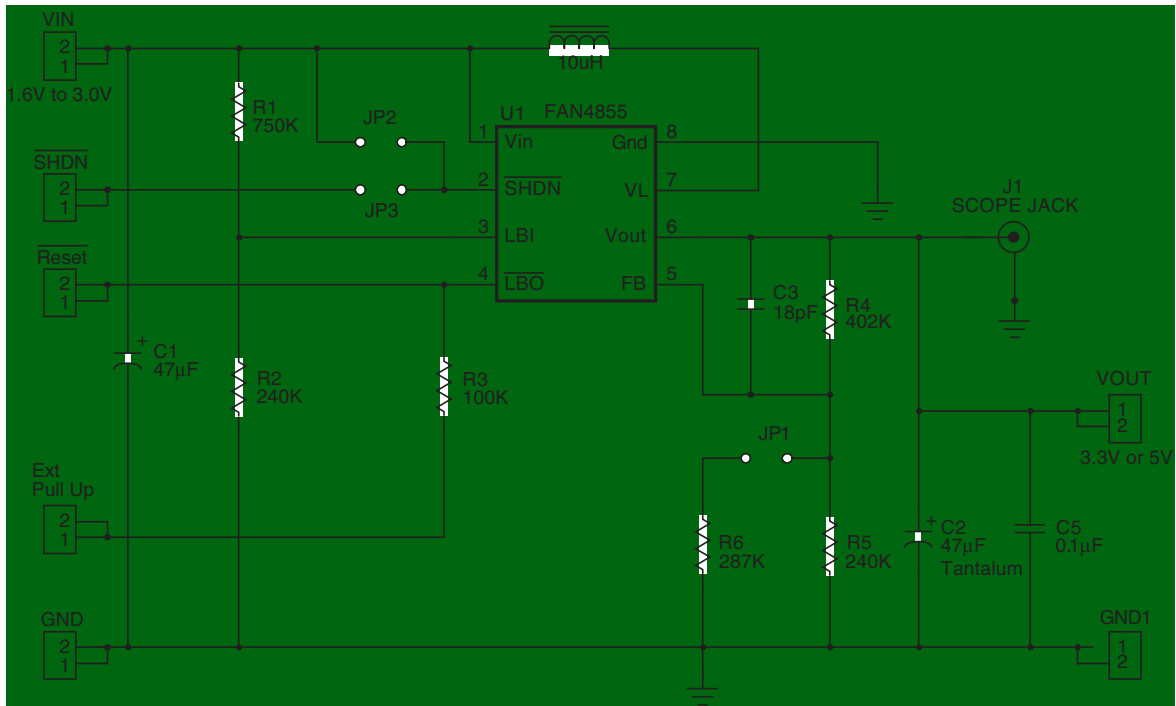
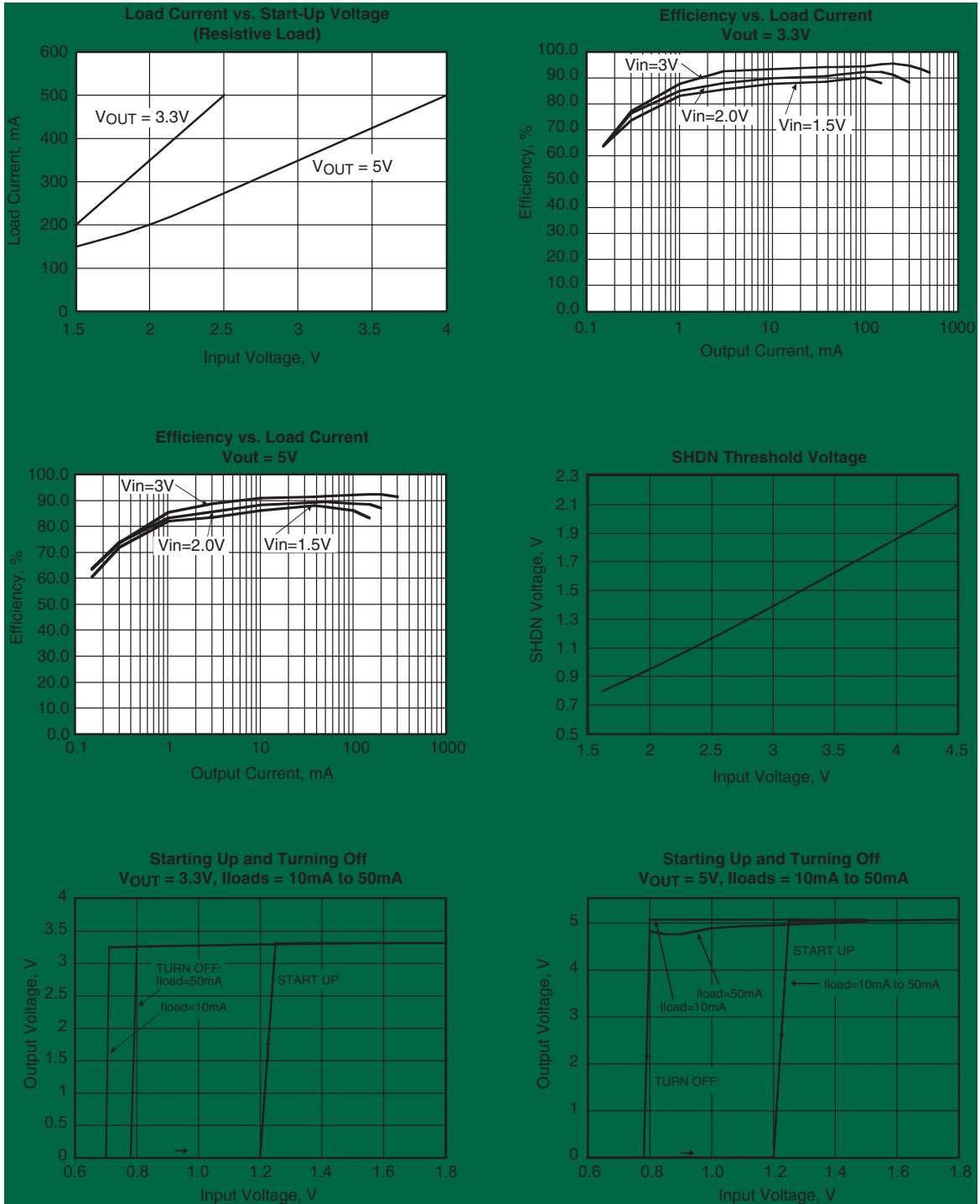
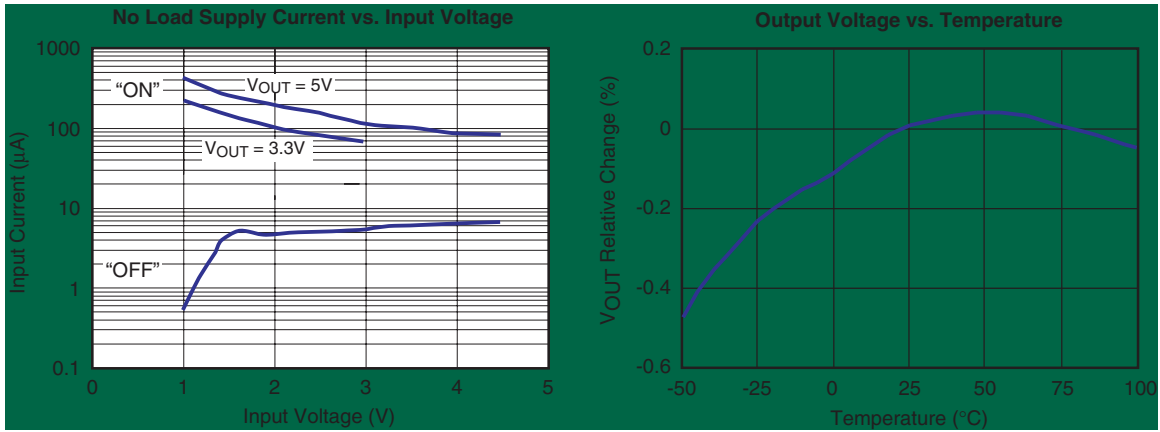

Figure 1. Test Circuit

Typical Operating Characteristics (L = 10 μ H, C_{IN} = 47 μ F, C_{OUT} = 47 μ F/1.0 μ F, T = 25 $^{\circ}$ C)



Typical Operating Characteristics ($L = 10\mu\text{H}$, $C_{\text{IN}} = 47\mu\text{F}$, $C_{\text{OUT}} = 47\mu\text{F}/1.0\mu\text{F}$, $T = 25^\circ\text{C}$)



Typical Operating Characteristics (Continued)

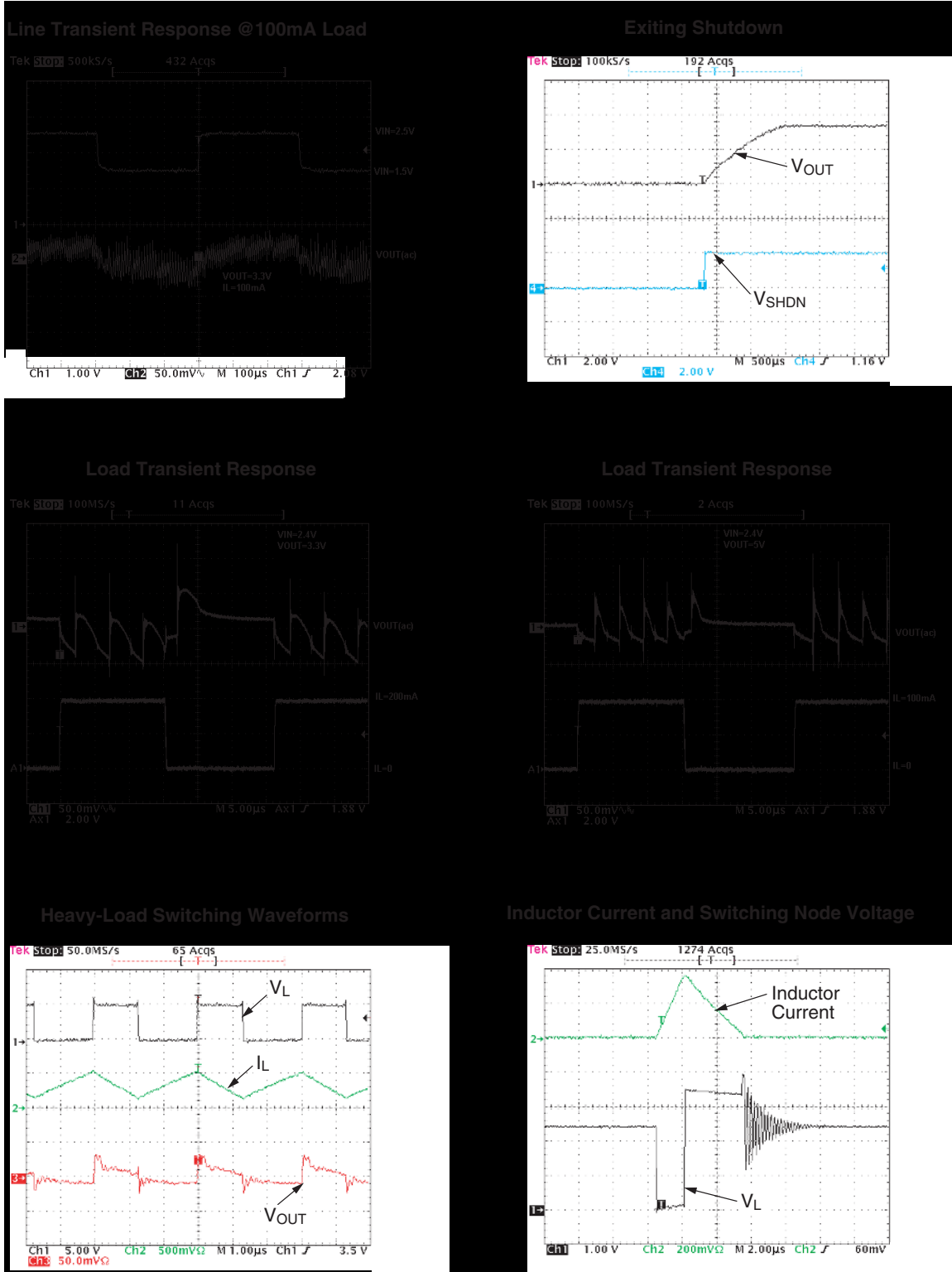

Block Diagram

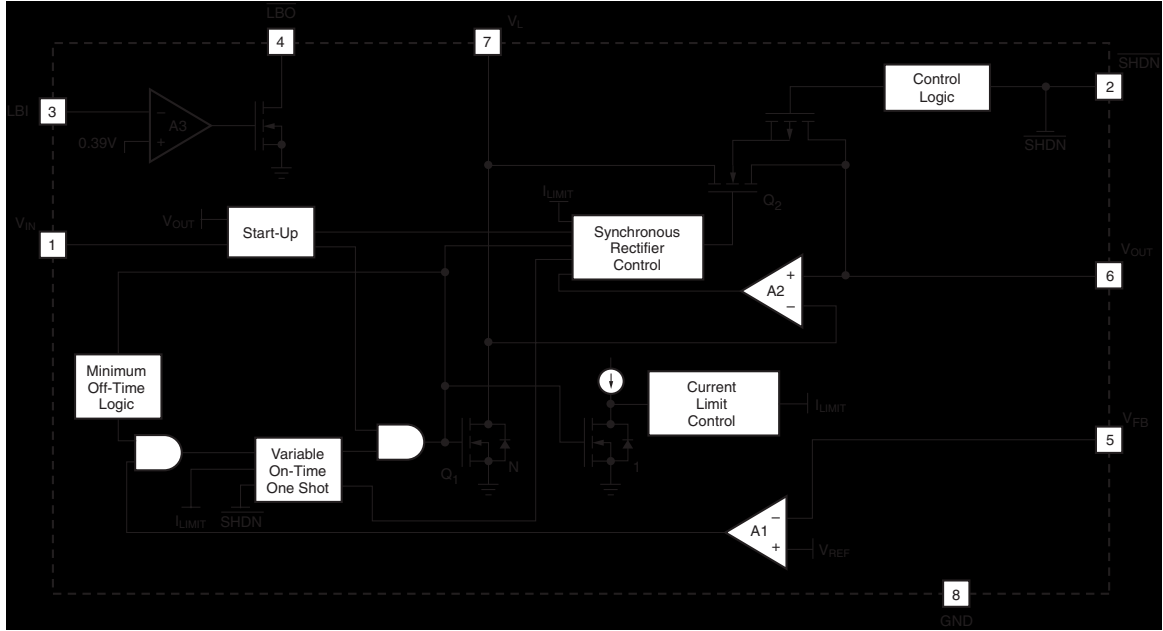

Functional Description

Boost Regulator

FAN4855 is an adjustable boost regulator that combines variable ON and minimum OFF architecture with synchronous rectification. Unique control circuitry provides high-efficiency power conversion for both light and heavy loads by transitioning between discontinuous and continuous conduction mode based on load conditions. There is no oscillator; a constant-peak-current limit of 0.8A in the inductor allows the inductor current to vary between this peak limit and some lesser value. The switching frequency depends upon the load, the input and output voltage ranging up to 430kHz.

The input voltage V_{IN} comes to V_{IN} pin and through the external inductor to the V_L pin of the device. The loop from V_{OUT} closes through the external resistive voltage divider to the feedback pin V_{FB} . The transfer ratio of this divider determines the output voltage. When V_{FB} voltage drops below the $V_{REF} = 1.24V$ the error amplifier A1 signals to regulator to deliver charge to the output by triggering the Variable On-Time One Shot. One Shot generates a pulse at the gate of the Power NMOS transistor Q1. This transistor will charge the Inductor L1 for the time interval T_{ON} resulting in a peak current given by:

$$I_{L(PEAK)} = \frac{T_{ON} \times V_{IN}}{L_1}$$

When the one-shot times out, the Q1 transistor releases the V_L pin, allowing the inductor to fly-back and momentarily charge the output through the body diode of the transistor Q2. But, as the voltage across the Q2 changes polarity, its gate will be driven low by the Synchronous Rectifier Control Circuit (SRC), causing Q2 to short out its body diode. The inductor then delivers the charge to the load by discharging into it through Q2.

Under light load conditions, the amount of energy delivered in this single pulse satisfies the voltage-control loop, and the converter does not command any more energy pulses until the output drops again below the lower-voltage threshold. Under medium and heavy loads, a single energy pulse is not sufficient to force the output voltage above its upper threshold before the minimum off time has expired and a second charge cycle is commanded. Since the inductor current has not reached zero in this case, the peak current is greater than the previous value at the end of the second cycle. The result is a ratcheting of inductor current until either the output voltage is satisfied, or the converter reaches its set current limit.

After a period of time $T_{OFF} > 1\mu s$, determined by Minimum Off-Time Logic and if V_{OUT} is low ($V_{FB} < V_{REF}$), the Variable On-Time One Shot will be turned ON again and the process repeats.

The output capacitor of the converter filters the variable component, limiting the output voltage ripple to a value determined by its capacitance and its ESR.

The synchronous rectifier significantly improves efficiency without the addition of an external component, so that conversion efficiency can be as high as 94% over a large load range, as shown in the Typical Operating Characteristics. Even at light loads, the efficiency stays high because the switching losses of the converter are minimized by reducing the switching frequency.

Error Detection Comparator (LBI – LBO)

An additional comparator A3 is provided to detect low V_{IN} or any other error conditions that is important to the user. The non-inverting input of the comparator is internally connected to a reference threshold voltage V_{th} while the inverting input is connected to the LBI pin. The output of the low battery comparator is a simple open-drain output that goes active low if the battery voltage drops below the programmed threshold voltage on LBI. The output requires a pull-up resistor having a recommended value of 100 k Ω , should be connected only to V_{OUT} .

The low-battery detector circuit is typically used to supervise the battery voltage and to generate an error flag or a RESET command when the battery voltage drops below a user-set threshold voltage. The function is active only when the device is enabled. When the device is disabled, the LBO-pin is high impedance.

Shutdown

The device enters shutdown when V_{SHDN} is approximately less than $0.5V_{IN}$. During shutdown the regulator stops switching, all internal control circuitry including the low-battery comparator is switched off and the load is disconnected from the input. The output voltage may drop below the input voltage during shutdown. The typical dependence shutdown voltage versus input voltage and the timing process of the exiting shutdown are shown on the Diagrams. For normal operation V_{SHDN} should be driven up $0.8V_{IN}$ or connected to the V_{IN} .

Application Information

Selecting the Output Voltage

The output voltage V_{OUT} can be adjusted from 3V to 5V, choosing resistors R4 and R5 of the divider in the feedback circuit (see Test Circuit). The value of the R5 is recommended to be less than 270k. R4 can be calculated using the following equation:

$$R4 = R5[(V_{OUT}/V_{REF}) - 1]$$

where $V_{REF} = 1.24V$

Setting the LBI Threshold of Low-Battery Detector Circuit

The LBO-pin goes active low when the voltage on the LBI-pin decreases below the set threshold typical voltage of 390 mV, which is set by the internal reference voltage.

The battery voltage, at which the detection circuit switches, can be programmed with a resistive divider connected to the LBI-pin. The resistive divider scales down the battery voltage to a voltage level of tenths of volt, which is then compared to the LBI threshold voltage. The LBI-pin has a built-in hysteresis of 25 mV. The resistor values R1 and R2 can be calculated using the following equation:

$$V_{IN_MIN} = 0.39 \times (R1+R2)/R2$$

The value of R2 should be 270k or less to minimize bias current errors. R1 is then found by rearranging the equation:

$$R1 = R2 \times (V_{IN_MIN}/0.39 - 1)$$

If the low-battery detection circuit is not used, the LBI-pin should be connected to GND (or to V_{IN}) and the LBO-pin can be left unconnected or tied to GND. Do not let the LBI-pin float.

Component Selection

Input and Output Capacitors Selection

For common general purpose applications, 47 μ F tantalum capacitors are recommended. Ceramic capacitors are recommended at input only; if connected at the output they cannot improve significantly the voltage ripple. More effective in reducing the output ripple at light load is to connect a small capacitor of 18 to 100pF between V_{OUT} and FB pin.

Table 1. Recommended capacitors

Vendor	Description
MuRata	X5R Ceramic
AVX	TAJ,TPS series tantalum
Sprague	595D series tantalum
Kemet	T494 series tantalum

Inductor Selection

The inductor parameters directly influencing the device performance are the saturation current and the DC resistance. The FAN4855 operates with a typical inductance of 10 μ H. The lower the resistance, the higher the efficiency. The saturation current should be rated higher than 0.8A, which is the typical threshold to switch off the N-channel power FET.

Table 2. Recommended Inductors

Supplier	Manufacturer Part Number
MuRata	LQ66C100M4
Coilcraft	DT1608C-103
Coiltronics	UP1B100
Sumida	CDR63B-100

Layout and Grounding Considerations

Careful design of printed circuit board is recommended since high frequency switching and high peak currents are present in DC/DC converters applications. A general rule is to place the converter circuitry well away from any sensitive analog components. The printed circuit board layout should be based on some simple rules to minimize EMI and to ensure good regulation performances:

1. Place the IC, inductor, input and output capacitor as close together as possible.
2. Keep the output capacitor as close to the FAN4855 as possible with very short traces to V_{OUT} and GND pins. Typically it should be within 0.25 inches or 6 mm.
3. Keep the traces for the power components wide, typically > 50 mils or 1.25 mm.
4. Place the external networks for LBI and FB close to FAN4855, but away from the power components as far as possible to prevent voltage transient from coupling into sensitive nodes.
5. On multilayer boards use component side copper for grounding around the IC and connect back to a quiet ground plane using vias. The ground planes act as electromagnetic shields for some of the RF energy radiated.
6. The connection of the GND pin of the IC (pin 8) to the overall grounding system should be directly to the bottom of the output filter capacitor. A star grounding system radiating from where the power enters the PCB, is a recommended practice.

Application Example

The FAN4855 can be used as a constant current source to drive white LEDs like QTLP670C-IW. As shown in the diagram below, the current is maintained constant over a wide range of input voltages.

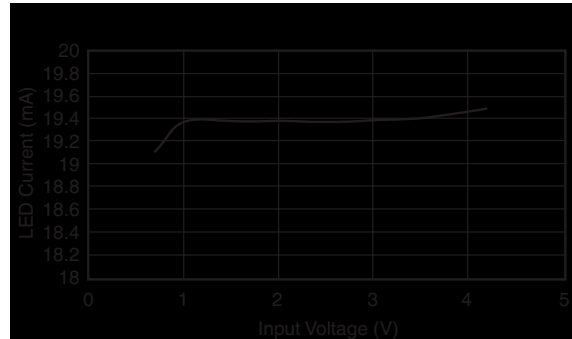
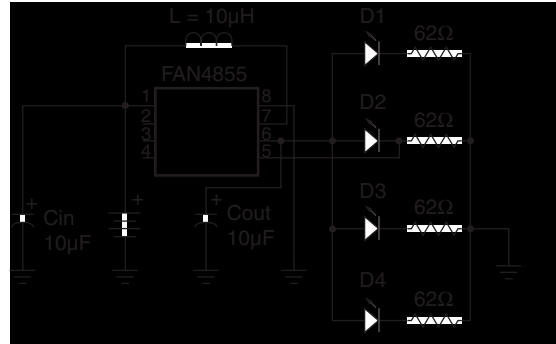

Mechanical Dimensions

Package: T08, 8-Pin TSSOP

